

Approval body for construction products
and types of construction

Bautechnisches Prüfamt

An institution established by the Federal and
Laender Governments



European Technical Assessment

ETA-18/0242
of 30 October 2018

English translation prepared by DIBt - Original version in German language

General Part

Technical Assessment Body issuing the
European Technical Assessment:

Deutsches Institut für Bautechnik

Trade name of the construction product

fischer concrete screw ULTRACUT FBS II

Product family
to which the construction product belongs

Fasteners for use in concrete for redundant
non-structural systems

Manufacturer

fischerwerke GmbH & Co. KG
Klaus-Fischer-Straße 1
72178 Waldachtal
DEUTSCHLAND

Manufacturing plant

fischerwerke

This European Technical Assessment
contains

15 pages including 3 annexes which form an integral part
of this assessment

This European Technical Assessment is
issued in accordance with Regulation (EU)
No 305/2011, on the basis of

EAD 330747-00-0601

The European Technical Assessment is issued by the Technical Assessment Body in its official language. Translations of this European Technical Assessment in other languages shall fully correspond to the original issued document and shall be identified as such.

Communication of this European Technical Assessment, including transmission by electronic means, shall be in full. However, partial reproduction may only be made with the written consent of the issuing Technical Assessment Body. Any partial reproduction shall be identified as such.

This European Technical Assessment may be withdrawn by the issuing Technical Assessment Body, in particular pursuant to information by the Commission in accordance with Article 25(3) of Regulation (EU) No 305/2011.

Specific Part

1 Technical description of the product

The fischer concrete screw ULTRACUT FBS II is an anchor of size 6 mm made of hardened carbon steel. The anchor is screwed into a predrilled cylindrical drill hole. The special thread of the anchor cuts an internal thread into the member while setting. The anchorage is characterised by mechanical interlock in the special thread.

The product description is given in Annex A.

2 Specification of the intended use in accordance with the applicable EAD

The performances given in Section 3 are only valid if the anchor is used in compliance with the specifications and conditions given in Annex B.

The verifications and assessment methods on which this European Technical Assessment is based lead to the assumption of a working life of the anchor of at least 50 years. The indications given on the working life cannot be interpreted as a guarantee given by the producer, but are to be regarded only as a means for choosing the right products in relation to the expected economically reasonable working life of the works.

3 Performance of the product and references to the methods used for its assessment

3.1 Safety in case of fire (BWR 2)

| Essential characteristic | Performance |
|--------------------------|---------------|
| Reaction to fire | Class A1 |
| Resistance to fire | See Annex C 3 |

3.2 Safety in use (BWR 4)

| Essential characteristic | Performance |
|---|-----------------------|
| Characteristic resistance to tension load (static and quasi-static loading) | See Annex C 1 and C 2 |
| Characteristic resistance to shear load (static and quasi-static loading) | See Annex C 1 and C 2 |

4 Assessment and verification of constancy of performance (AVCP) system applied, with reference to its legal base

In accordance with European Assessment Document EAD No. 330747-00-0601, the applicable European legal act is: [97/161/EC].

The system to be applied is: 2+

5 Technical details necessary for the implementation of the AVCP system, as provided for in the applicable European Assessment Document

Technical details necessary for the implementation of the AVCP system are laid down in the control plan deposited at Deutsches Institut für Bautechnik.

Issued in Berlin on 30 October 2018 by Deutsches Institut für Bautechnik

Dr.-Ing. Lars Eckfeldt
p. p. Head of Department

beglaubigt:
Tempel

Product in the installed condition

Installed condition in normal weight concrete

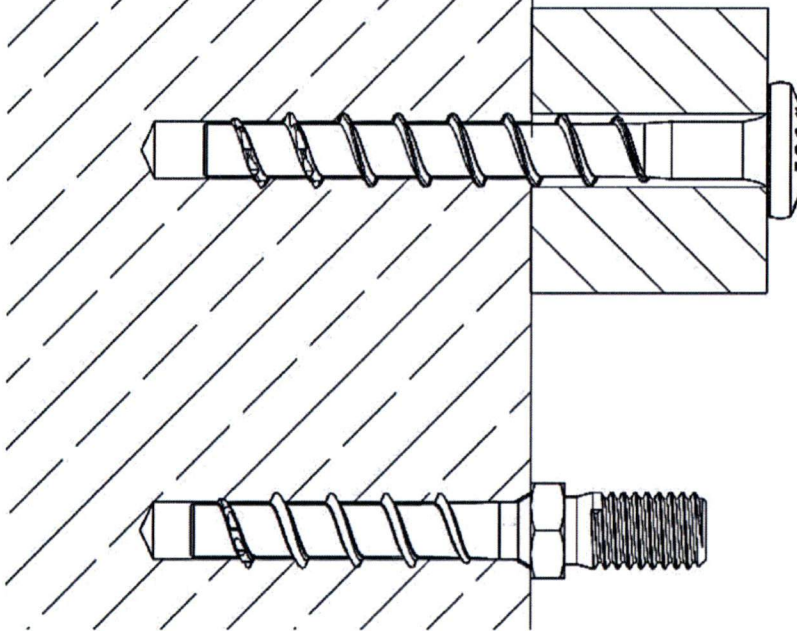

Installed condition in
prestressed hollow core slabs

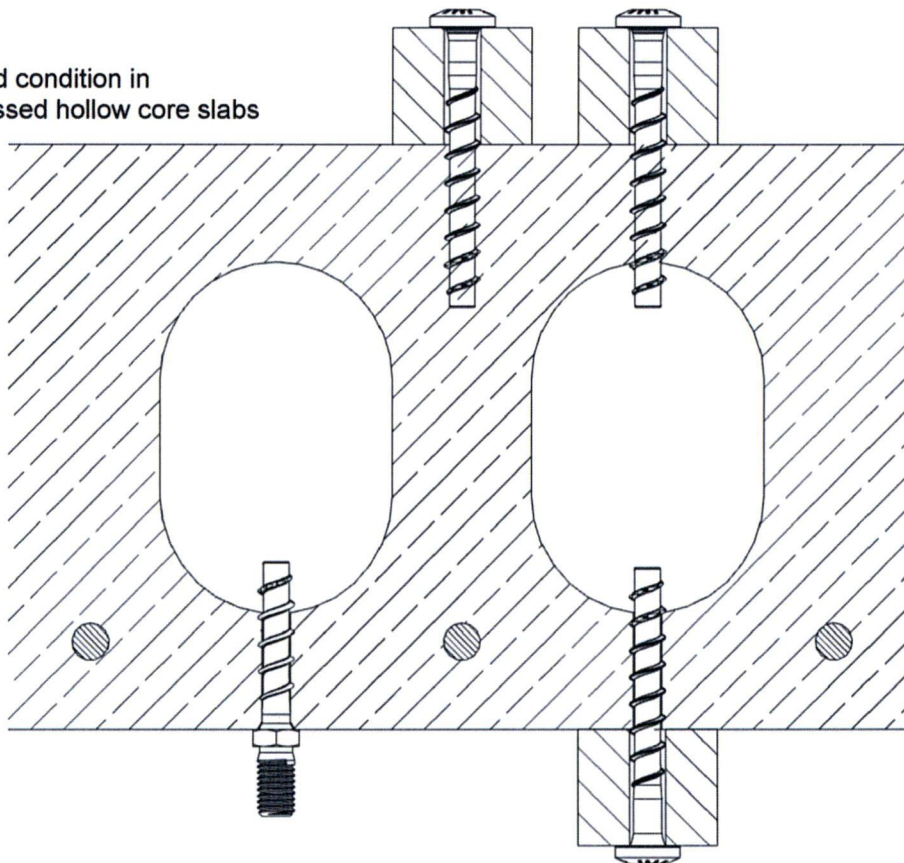

fischer concrete screw ULTRACUT FBS II

Product description
Product in the installed condition

Annex A 1











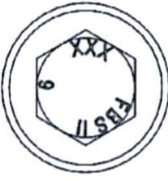
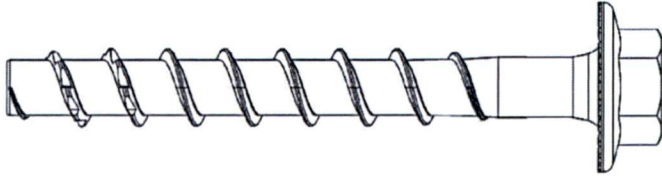

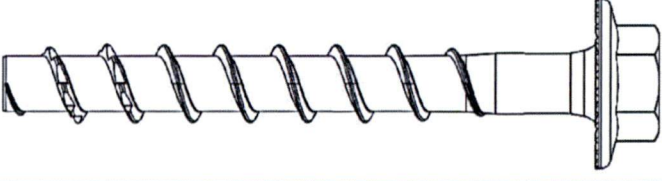
| Table A2.1: Screw types | | |
|--|---|--|
| FBS II 6 | | |
| Hexagon head with formed washer (US) |  |  |
| Hexagon head with formed washer and TX-drive (US TX) |  |  |
| Countersunk head (SK) |  |  |
| Pan head (P) |  |  |
| Large pan head (LP) |  |  |
| Hexagon head and connection thread M8 or M10 (M) |  |  |
| Internal thread M8 / M10 combined (M8 / M10 I) |  |  |
| fischer concrete screw ULTRACUT FBS II | | Annex A 2 |
| Product description Screw types | | |

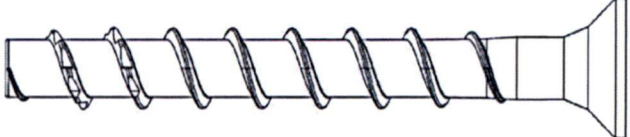
Table A3.1: Geometry and material

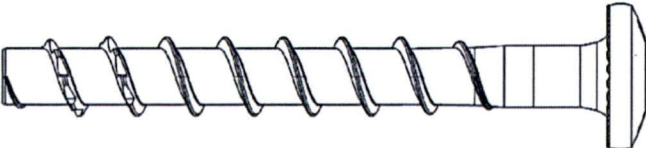
| FBS II 6 | | All head shapes | |
|-----------------------|-------|---|------|
| Thread outer diameter | d_a | [mm] | 7,75 |
| Core diameter | d_k | | 5,65 |
| Shaft diameter | d_s | | 6,0 |
| Material | [-] | Hardened carbon steel; $A_{5\%} \geq 8\%$ | |
| Coating | | galvanized | |

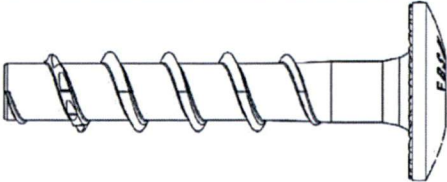

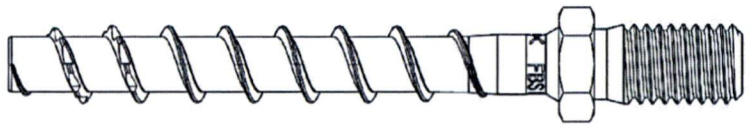
Head marking at US, US TX, SK, P, LP

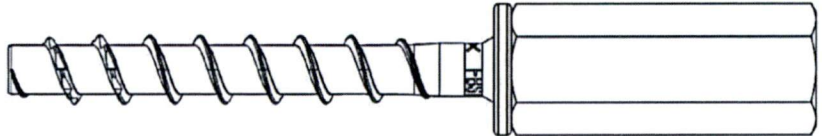
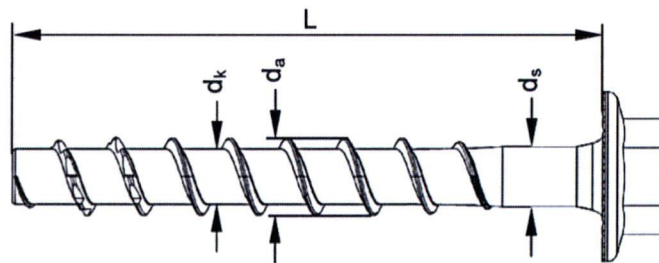
FBS II: Product identification

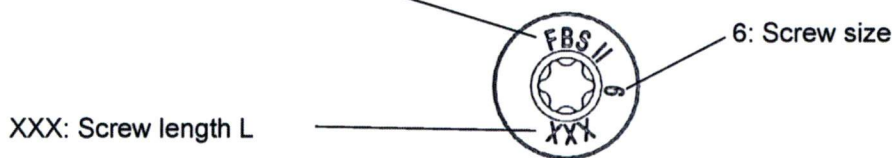

Marking at M8, M10, M8 / M10 I

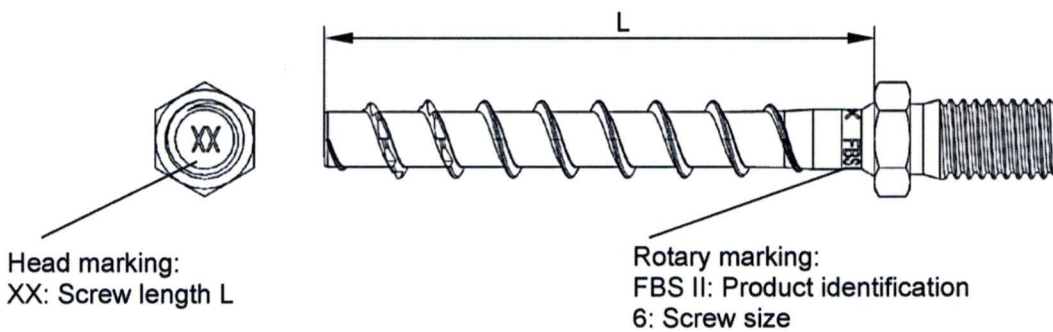

fischer concrete screw ULTRACUT FBS II

Product description
Geometry and marking

Annex A 3

Specification of intended use:

Anchorage subject to:

- Static and quasi static loads: all types and embedment depths
- Used in concrete for redundant non-structural systems
- Used for fire: only for concrete C20/25 to C50/60 (does not apply for prestressed hollow core slabs)

Base materials:

- Compacted reinforced or unreinforced normal weight concrete without fibres according to EN 206:2013
- Strength classes C20/25 to C50/60 according to EN 206:2013
- Uncracked or cracked concrete
- Prestressed hollow core slabs, where the cavity width does not exceed 4.2 times the web width ($b_H \leq 4,2 \times b_{St}$) with strength classes C30/37 to C50/60

Use conditions (Environmental conditions):

- Structures subjected to dry internal conditions

Design:

- Anchorages are to be designed under the responsibility of an engineer experienced in anchorages and concrete work
- Verifiable calculation notes and drawings are to be prepared taking account of the loads to be anchored. The position of the screw is indicated on the design drawings (e.g. position of the screw relative to reinforcement or to supports, etc.)
- Design of fastenings according to FprEN 1992-4: 2016 and EOTA Technical Report TR 055

Installation:

- Hammer drilling or hollow drilling
- Screw installation carried out by appropriately qualified personnel and under the supervision of the person responsible for technical matters on site
- In case of aborted hole: New hole must be drilled at a minimum distance of twice the depth of the aborted hole or closer, if the hole is filled with a high strength mortar and only if the hole is not in the direction of the oblique tensile or shear load
- Adjustability according to Annex B3
- Cleaning of drill hole is not necessary when using a hollow drill or:
 - If drilling vertically upwards
 - If drilling vertically downwards and the drill hole depth has been increased. It is recommended to increase the drill depth with additional $3 d_0$
- After correct installation further turning of the screw head shall not be possible
- The head of the screw must be fully engaged on the fixture and show no signs of damage
- In prestressed hollow core slabs the screw may be installed from all directions, if the web thickness and the spacing to the tensioning strands according to table B3.1 are observed (also in the area of solid material)

fischer concrete screw ULTRACUT FBS II

Intended use
Specification

Annex B 1

Table B2.1: Installation parameters – drilling bore hole and setting tools

| FBS II 6 | | All head shapes | |
|--|----------------|------------------------|---------------------------|
| Nominal embedment depth | h_{nom} | $25 \leq h_{nom} < 35$ | $35 \leq h_{nom} \leq 55$ |
| Nominal drill hole diameter | d_0 | 6 | |
| Cutting diameter of drill bits | $d_{cut} \leq$ | 6,4 | |
| Clearance hole diameter | $d_f \leq$ | 8 | |
| Drill hole depth | | $h_{nom} + 5$ | $h_{nom} + 10^{1)}$ |
| Drill hole depth (with adjustable setting) | $h_1 \geq$ | $h_{nom} + 15$ | $h_{nom} + 20$ |
| Torque impact screw driver | $T_{imp,max}$ | 80 | 450 |
| Maximum installation torque with hexagon nut on head shapes M8, M10 and M8/M10 I | T_{max} | 5 | 10 |

¹⁾ Value can be reduced to $h_{nom} + 5$ for installation vertically upwards

Table B2.2: Installation parameters – drive and fixture

| FBS II 6 | | US | US TX | SK | P | LP | M8 | M10 | M8/M10 I | |
|----------------------|----------------|---------------|-------|------|------|----|----|-----|----------|--|
| Wrench size | SW [mm] | 10 | | - | | | 10 | 13 | | |
| TX size | TX [-] | - | 30 | | | | | | | |
| Head diameter | d_h | 17 | 13,5 | 14,4 | 17,5 | - | | | | |
| Thickness of fixture | $t_{fix} \leq$ | L - h_{nom} | | | | | | | | |
| Length of screw | $L_{min} =$ | 25 | | | | | | | | |
| | $L_{max} =$ | 325 | | | | | 55 | | | |

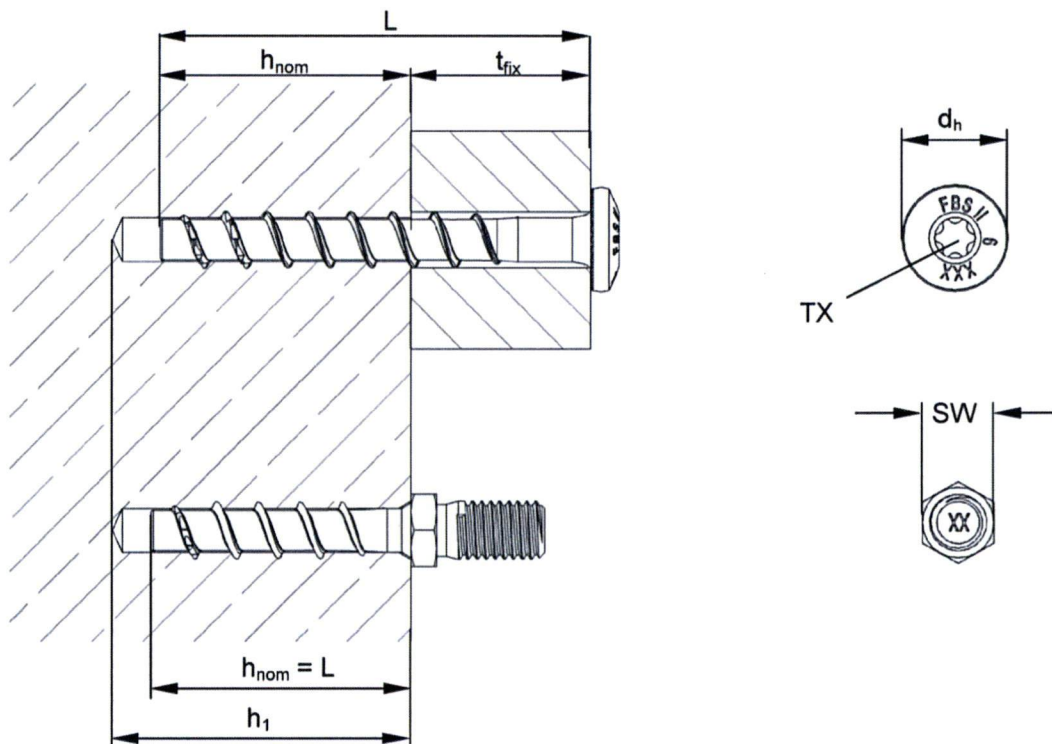

fischer concrete screw ULTRACUT FBS II

Intended use
Installation parameters

Annex B 2

Table B3.1: Installation parameters – Additional information for prestressed hollow core slabs

| FBS II 6 | | | |
|------------------------------------|----------------|------|-------------------------|
| Distance to the tensioning strands | $a_p \geq$ | | 50 |
| Thickness of the slab web | $d_b \geq$ | [mm] | 25 |
| Minimum thickness of fixture | $t_{fix} \geq$ | | $L - d_b^{1)}$ - 30 mm |
| Torque impact screw driver | $T_{imp,max}$ | [Nm] | 80 (450 ²⁾) |

- 1) If d_b is not known, then set $d_b = 25$ mm
 2) Parent value applies if all the following conditions are met:
 - $d_b \geq 35$ mm
 - $h_{nom} \geq 35$ mm

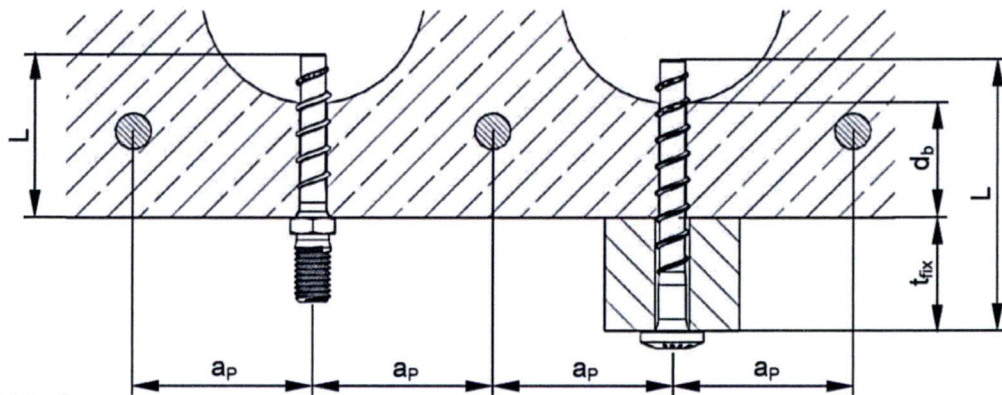

Adjustment

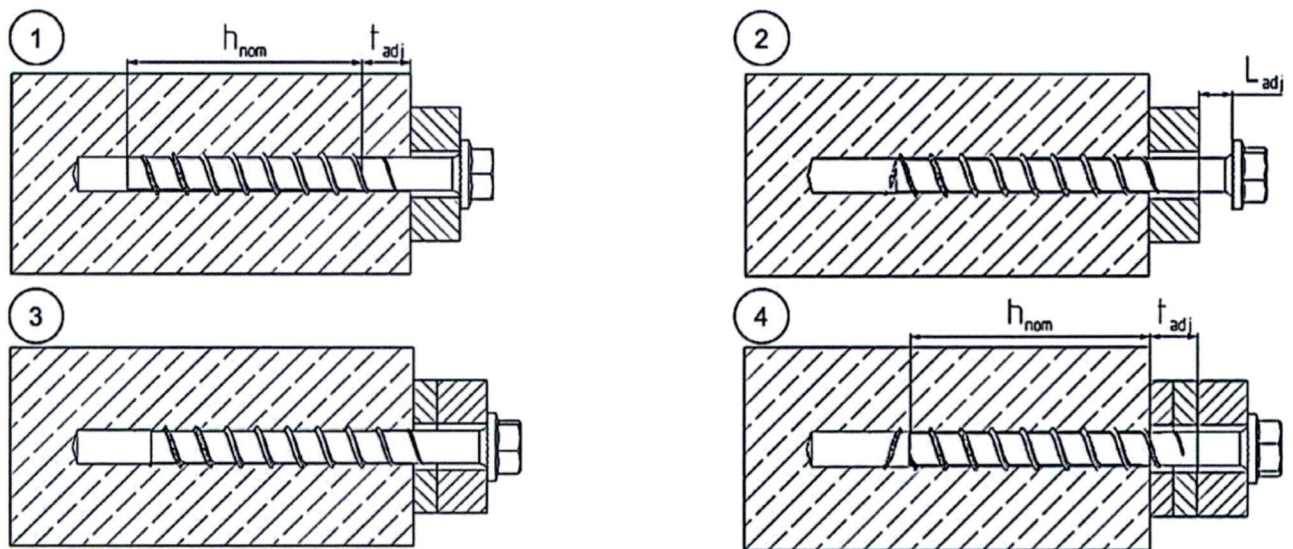

It is permissible to untighten the screw up to two times for adjustment purposes.
 Therefore the screw may be untightened to a maximum of $L_{adj} = 20$ mm to the surface of the initial fixture.
 The total permissible thickness of shims added during the adjustment process is $t_{adj} = 10$ mm.

fischer concrete screw ULTRACUT FBS II

Intended use
Prestressed hollow core slabs and adjustment

Annex B 3

| Table B4.1: Minimum thickness of concrete members, minimum spacing and edge distance | | | |
|---|-----------|------|---------------------------|
| FBS II 6 | | | |
| Minimum thickness of concrete member | h_{min} | | $\max.(80; h_1^{1}) + 30$ |
| Minimum spacing | s_{min} | | 35 |
| Minimum edge distance | c_{min} | | |
| 1) Drill hole depth according to table B2.1 | | | |
| Table B4.2: Minimum spacing and edge distance for prestressed hollow core slabs | | | |
| FBS II 6 | | | |
| Minimum spacing | s_{min} | [mm] | 100 |
| Minimum edge distance | c_{min} | | |
| Minimum distance between anchor groups | a_{min} | | |
| fischer concrete screw ULTRACUT FBS II | | | Annex B 4 |
| Intended use Minimum thickness of members, minimum spacing and edge distance | | | |

Installation instruction

Installation of fischer concrete screw ULTRACUT FBS II 6

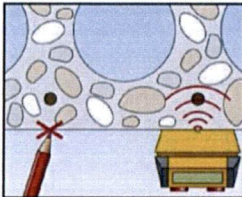
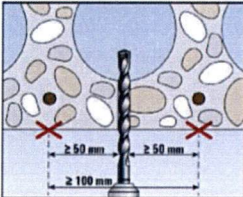
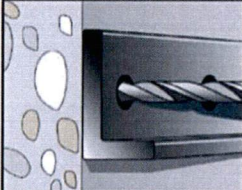
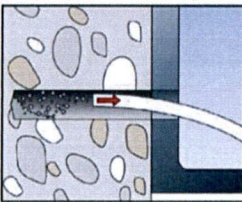
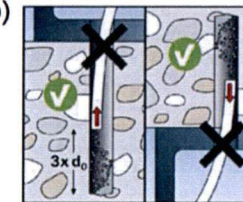
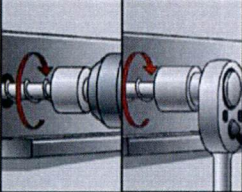
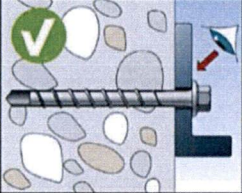
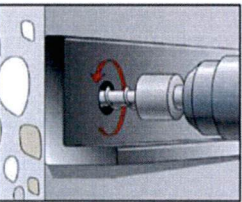
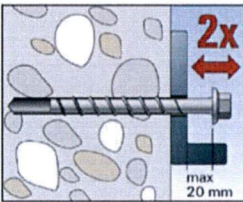
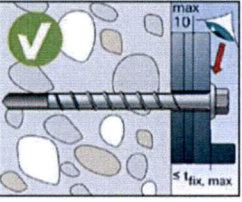
| | |
|---|---|
| <p>1. </p> <p>2. </p> | <p>For installation in prestressed hollow core slabs: Determine and mark the position of the tensing strands, e.g. with a suitable scanner. Keep distances to the tensing strands according to table B3.1.</p> |
|  | <p>Drill the hole using hammer drill or hollow drill. Drill hole diameter d_0 and drill hole depth h_1 according to table B2.1</p> |
| <p>a) </p> <p>b) </p> | <p>Option a): Clean the drill hole Option b): Cleaning of drill hole is not necessary when using a hollow drill or: - If drilling vertically upwards or - If drilling vertically downwards and the drill hole depth has been increased. It is recommended to increase the drill hole depth additional 3 times d_0.</p> |
|  | <p>Installation with any torque impact screw driver up to the maximum mentioned torque moment ($T_{imp,max}$ according table B2.1). Alternatively, all other tools without an indicated torque moment are allowed (e.g. ratchet spanner). The indicated torque moments for impact screw driver are therefore not decisive.</p> |
|  | <p>After installation a further turning of the screw must not be possible. The head of the screw must be in contact with the fixture and is not damaged.</p> |
| <p>1. </p> <p>2. </p> <p>3. </p> | <p>OPTIONAL: It is permissible to adjust the screw twice. Therefore the screw may be untightened to a maximum of $L_{adj} = 20$ mm off the surface of the initial fixture. The total permissible thickness of shims added during the adjustment process is $t_{adj} = 10$ mm.</p> |

fischer concrete screw ULTRACUT FBS II

Intended use
Installation instruction

Annex B 5

| Table C1.1: Characteristic values for static and quasi-static action | | | | | | | | | | |
|---|-----------------|------------|--------------|------|-----|-----|----------------|------|------------------|------|
| FBS II 6 | | | | | | | | | | |
| Nominal embedment depth | h_{nom} | [mm] | 25 | 30 | 35 | 40 | 45 | 50 | 55 | |
| Steel failure for tension load and shear load | | | | | | | | | | |
| Characteristic resistance | $N_{Rk,s}$ | [kN] | 21 | | | | | | | |
| Partial factor | γ_{Ms} | [-] | 1,4 | | | | | | | |
| Characteristic resistance | $V_{Rk,s}$ | [kN] | 4,8 | 9,0 | | | | 13,3 | | |
| Partial factor | γ_{Ms} | [-] | 1,5 | | | | | | | |
| Factor for ductility | k_7 | [-] | 1,0 | | | | | | | |
| Characteristic bending resistance | $M^0_{Rk,s}$ | [Nm] | 17,1 | | | | | | | |
| Pullout failure | | | | | | | | | | |
| Characteristic resistance in concrete C20/25 | uncracked | $N_{Rk,p}$ | [kN] | 3,0 | 5,0 | 6,5 | 8,0 | 10,0 | 12,0 | 13,5 |
| | cracked | | | 1,5 | 2,5 | 3,5 | 5,0 | 6,0 | 7,5 | 8,5 |
| Increasing factors concrete | C25/30 | ψ_c | [-] | 1,12 | | | | | | |
| | C30/37 | | | 1,22 | | | | | | |
| | C35/45 | | | 1,32 | | | | | | |
| | C40/50 | | | 1,41 | | | | | | |
| | C45/55 | | | 1,50 | | | | | | |
| | C50/60 | | | 1,58 | | | | | | |
| Installation factor | γ_{inst} | | | 1,0 | | | | | | |
| Concrete cone failure and splitting failure; concrete pryout failure | | | | | | | | | | |
| Effective embedment depth | h_{ef} | [mm] | 19 | 23 | 27 | 32 | 36 | 40 | 44 | |
| Factor for uncracked concrete | $k_{ucr,N}$ | [-] | 11,0 | | | | | | | |
| Factor for cracked concrete | $k_{cr,N}$ | | 7,7 | | | | | | | |
| Characteristic edge distance | $c_{cr,N}$ | [mm] | 1,5 h_{ef} | | | | | | | |
| Characteristic spacing | $s_{cr,N}$ | | 3 h_{ef} | | | | | | | |
| Charakt. resistance for splitting | $N^0_{Rk,sp}$ | [kN] | $N_{Rk,c}$ | | | | | | | |
| Charact. edge distance for splitting | $c_{cr,sp}$ | [mm] | 2 x h_{ef} | | | | 1,5 x h_{ef} | | | |
| Charakt. spacing for splitting | $s_{cr,sp}$ | | 4 x h_{ef} | | | | 3 x h_{ef} | | | |
| Factor for pryout failure | k_8 | [-] | 1,3 | | | 2,0 | | | | |
| Installation factor | γ_{inst} | | 1,0 | | | | | | | |
| Concrete edge failure | | | | | | | | | | |
| Effective length in concrete | l_f | [mm] | 25 | 30 | 35 | 40 | 45 | 50 | 55 | |
| Nominal diameter of screw | d_{nom} | | 6 | | | | | | | |
| Adjustment | | | | | | | | | | |
| Maximum thickness of shims | t_{adj} | [mm] | 10 | | | | | | | |
| Max. number of adjustments | n_a | [-] | 2 | | | | | | | |
| fischer concrete screw ULTRACUT FBS II | | | | | | | | | Annex C 1 | |
| Performances Characteristic values | | | | | | | | | | |

| Table C2.1: Characteristic values for static and quasi-static action in prestressed hollow core slabs | | | | | | | | | | |
|---|------------------|------------|------|------|-----|-----|-----|-----|------------------|------|
| FBS II 6 | | | | | | | | | | |
| Nominal embedment depth | h_{nom} | [mm] | 25 | 30 | 35 | 40 | 45 | 50 | 55 | |
| Steel failure for tension load and shear load | | | | | | | | | | |
| Characteristic resistance | $N_{Rk,s}$ | [kN] | 21 | | | | | | | |
| Partial factor | γ_{Ms} | [-] | 1,4 | | | | | | | |
| Characteristic resistance | $V_{Rk,s}$ | [kN] | 4,8 | 9,0 | | | | | 13,3 | |
| Partial factor | γ_{Ms} | [-] | 1,5 | | | | | | | |
| Factor for ductility | k_7 | | 1,0 | | | | | | | |
| Characteristic bending resistance | $M^0_{Rk,s}$ | [Nm] | 17,1 | | | | | | | |
| Pullout failure, Concrete cone failure, Concrete edge failure, Concrete pryout failure for all load directions | | | | | | | | | | |
| Characteristic resistance in C30/37 for thickness of the slab web | $d_b \geq 25$ mm | $F_{Rk,p}$ | [kN] | 0,5 | 1,0 | | | | | |
| | $d_b \geq 30$ mm | | | 3,5 | | | | | | |
| | $d_b \geq 35$ mm | | | 3,5 | 4,0 | 4,5 | 5,0 | 5,5 | 6,0 | 6,5 |
| | $d_b \geq 40$ mm | | | | 5,0 | 5,5 | 6,0 | 7,0 | 7,5 | 8,0 |
| | $d_b \geq 50$ mm | | | | 5,5 | 7,0 | 8,0 | 9,5 | 11,0 | 12,0 |
| Increasing factor concrete | C35/45 | ψ_c | [-] | 1,08 | | | | | | |
| | C40/50 | | | 1,15 | | | | | | |
| | C45/55 | | | 1,22 | | | | | | |
| | C50/60 | | | 1,29 | | | | | | |
| Installation factor | γ_{inst} | [-] | 1,0 | | | | | | | |
| fischer concrete screw ULTRACUT FBS II | | | | | | | | | Annex C 2 | |
| Performances Characteristic values in prestressed hollow core slabs | | | | | | | | | | |

| Table C3.1: Characteristic values for resistance to fire ¹⁾ | | | | | | | | | | |
|---|-----------------|-------------|------|---------------|----|----|----|----|------------------|----|
| FBS II 6 | | | | | | | | | | |
| Nominal embedment depth | | h_{nom} | [mm] | 25 | 30 | 35 | 40 | 45 | 50 | 55 |
| Steel failure for tension load and shear load ($F_{Rk,s,fi} = N_{Rk,s,fi} = V_{Rk,s,fi}$) | | | | | | | | | | |
| Characteristic resistance for all head shapes | $F_{Rk,s,fi}$ | R30 | [kN] | 1,00 | | | | | | |
| | | R60 | | 0,60 | | | | | | |
| | | R90 | | 0,50 | | | | | | |
| | | R120 | | 0,40 | | | | | | |
| Characteristic bending resistance for all head shapes | $M^0_{Rk,s,fi}$ | R30 | [Nm] | 0,80 | | | | | | |
| | | R60 | | 0,50 | | | | | | |
| | | R90 | | 0,40 | | | | | | |
| | | R120 | | 0,35 | | | | | | |
| Edge distance | | | | | | | | | | |
| R30 to R120 | | $c_{cr,fi}$ | [mm] | 2 h_{ef} | | | | | | |
| In case of fire attack from more than one side, the minimum edge distance shall be ≥ 300 mm | | | | | | | | | | |
| Spacing | | | | | | | | | | |
| R30 to R120 | | $s_{cr,fi}$ | [mm] | 2 $c_{cr,fi}$ | | | | | | |
| ¹⁾ The embedment depth has to be increased for wet concrete by at least 30 mm compared to the given value. | | | | | | | | | | |
| fischer concrete screw ULTRACUT FBS II | | | | | | | | | Annex C 3 | |
| Performances Characteristic values for resistance to fire | | | | | | | | | | |