

# Wall diffusers









About Lindab	1
Comfort and Design	2
Product overview / symbols	3
Theory	4
Ceiling diffusers	5
Ceiling diffusers - visible	6
Plenum boxes	7
<b>Wall diffusers</b>	<b>8</b>
Nozzles	9
Ventiduct	10
Grilles	11
Displacement diffusers	12
VAV	13
Constant- / variable flow dampers	14
Air valves	15
Fresh air valves/overflow units	16
Cleanroom diffusers	17
Contents	18

# Lindab wall diffusers

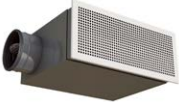
- 1
- 2
- 3
- 4
- 5
- 6
- 7
- 8
- 9
- 10
- 11
- 12
- 13
- 14
- 15
- 16
- 17
- 18

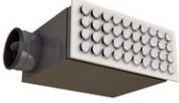







## Wall diffusers

Fronts

	Product	Functions	Page
<b>Combination overview</b>			
	<b>PR + WB</b>		<b>347</b>
	<b>NR + WB</b>		<b>353</b>
	<b>DR + WB</b>		<b>358</b>

## Wall grilles

Grilles

	Product	Functions	Page
	<b>B3020 + VBA</b>		<b>363</b>
	<b>C20/C21 + VBA</b>		<b>371</b>
	<b>F20 + VBA</b>		<b>377</b>
	<b>G20 + VBA</b>		<b>382</b>



NR19 + WB-2, side connection.



NR19 + WB-1, back connection.

# Wall diffusers



*C20, Oesterbro swimming hall, Copenhagen København.*

## Lindab wall diffusers

Wall diffusers, where the diffuser itself and the plenum box is placed in the wall or in a skirting board, is used in combination with - or as an alternative to ceiling diffusers. When the wall diffusers are used in combination with ceiling diffusers, the ceiling diffusers will typically be used for supply air and the wall diffusers for exhaust air. If the entire ceiling area has to be free for other installation needs, or because there isn't a suspended ceiling in the room, there is great advantage in using the wall diffusers for both supply air and exhaust air. That way you can avoid visible duct mounting in the room itself, and instead you get the possibility of placing air ducts in the corridor, hallway or other similar places.

In order to supply air to comfort zones, diffusers with an adjustable jet pattern or a built-in function to ensure the Coanda effect against the ceiling. That way too much velocity is avoided in the occupied zone.

## Design

Lindabs series of wall diffusers include a number of different fronts with different designs and functions to fulfil most requirements for this type of ventilation. The fronts are adapted to several types of plenum boxes, and consequently there is the possibility of combining supply air and exhaust air in the same design and with the same geometrical measurements. The plenum boxes WB are available with back- or side-connection and have built-in telescopic function to ease mounting. Furthermore, the box has a maximum width of 500 mm, which ensures that it is always possible to mount the box in an ordinary wall construction with a centre-distance of 600 mm between the plasterboards struts.

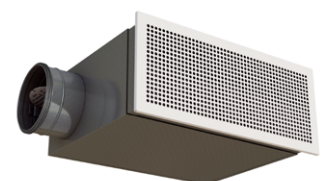

*PR1 + WB-2, with side connection.*

# Lindab wall diffusers

## Design

See chapter [Comfort and Design](#)

Product



**Function**  
Supp./exhau.

**Size A x B**

**Connection size WB**

**Connection size VBA**

## Plenum boxes

See [Plenum boxes](#)

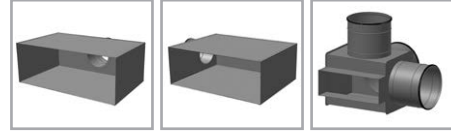

Product	Function	Supp./exhau.	Size A x B	Connection size WB	Connection size VBA
<b>Perforated</b>					
<b>PR</b>			300 x 100	80	160
			400 x 150	100	250
			500 x 150	125	250
			500 x 200	160	315
			500 x 300	200	
Nr.: 1					
Nr.: 2					
Nr.: 3					
Nr.: 4					
<b>Nozzles</b>					
<b>NR</b>			300 x 100	80	160
			400 x 150	100	250
			500 x 150	125	250
			500 x 200	160	315
			500 x 300	200	
<b>Adjustable blades</b>					
<b>DR</b>			300 x 100	80	160
			400 x 150	100	250
			500 x 150	125	250
			500 x 200	160	315
			500 x 300	200	
<b>Grilles</b>					
<b>B3020</b>			200 x 100		125
			300 x 100	80	160
			400 x 100		160
			500 x 100		200
			300 x 150		200
<b>C20 C21</b>			400 x 150	100	250
			500 x 150	125	250
			600 x 150		250
			400 x 200		250
			500 x 200	160	315
<b>F20</b>			600 x 200		315
			500 x 300	200	
<b>Inclined bars</b>					
<b>G20</b>			200 x 100		125
			300 x 100	80	160
			400 x 100		160
			500 x 100		200
			300 x 150		200
			400 x 150	100	250
			500 x 150	125	250
			600 x 150		250
			400 x 200		250
			500 x 200	160	315
			600 x 200		315
			500 x 300	200	

WB-1	WB-2	VBA-1-2-4

- 1. Products depicted in catalogue. Tech. data in catalogue.
- 2. Combination possible. Tech. data depicted in catalogue.
- 3. Combination possible. Tech. data not in catalogue.
- 4. If field is empty, combination is not possible.

# Wall diffuser

# PR1



## Description

PR1 is a rectangular diffuser for installation in a wall or skirting board with perforated front plate in various designs (see summary). The diffuser is suitable for the horizontal supply of cooled air and exhaust. The diffuser for supply air is used with a WB type plenum box, and for air exhaust, with a VBA type plenum box. The plenum boxes are equipped with a damper and measuring device, enabling individual adjustment.

- Large capacity
- Discrete appearance
- Regardless of straight ducting before the diffuser
- Telescopic function in the plenum box

## Maintenance

The front can be removed and the damper taken out for cleaning of internal parts or to gain access to the duct. The visible parts of the diffuser can be wiped with a damp cloth.

## Order code

<b>Product</b>	PR	a	B	A x B
<b>Type</b>	PR			
<b>Pattern</b>		Pattern 1 - 4		
<b>Functional use</b>		S ( Supply air ) E ( Exhaust air )		
<b>Size (A x B)</b>				300x100 - 500x300

<b>Product</b>	WB	a	A x B
<b>Type</b>	WB		
<b>Connection</b>		1 = Back 2 = Side	
<b>Size (A x B)</b>			300x100 - 500x300

Example: PR-1-S-400x150 + WB-1-400x150

## Dimensions

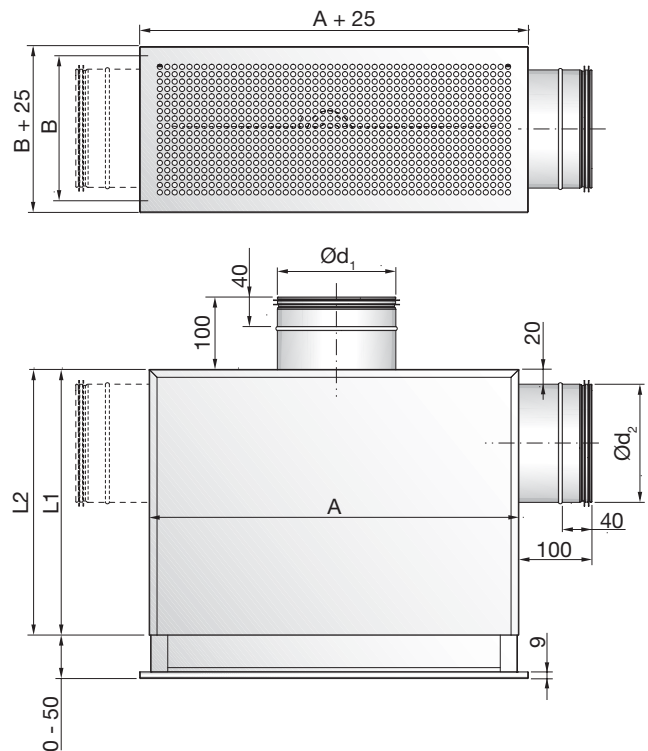

### WB-1 Back connection

A x B Size mm	Ød <sub>1</sub> mm	A mm	B mm	L1 mm	m kg
300 - 100	80	300	100	240	2,50
400 - 150	100	400	150	240	3,50
500 - 150	125	500	150	240	4,30
500 - 200	160	500	200	240	5,50
500 - 300	200	500	300	240	7,40

### WB-2 Side connection

A x B Size mm	Ød <sub>2</sub> mm	A mm	B mm	L2 mm	m kg
300 - 100	80	300	100	280	2,50
400 - 150	100	400	150	300	3,50
500 - 150	125	500	150	325	4,30
500 - 200	160	500	200	360	5,50
500 - 300	200	500	300	400	7,40

## Materials and finish

Diffuser: Galvanised steel  
 Standard finish: Powder-coated  
 Standard colour: 9010 white, gloss 30

The diffuser is available in other colours. Please contact Lindab's sales department for further information.

# Wall diffuser

PR1

## Technical data

### Capacity

Volume flow  $q_v$  [l/s] and [m<sup>3</sup>/h], total pressure loss  $\Delta p_t$  [Pa], throw  $l_{0,2}$  and sound level  $L_{WA}$  [dB(A)] can be seen in the diagrams.

### Frequency-related sound effect level

The sound effect level in the frequency band is defined as  $L_{WOK} = L_{WA} + K_{OK}$ .  $K_{OK}$  values are specified in charts beneath the diagrams on the following pages.

### Quick selection

#### WB-1 Back connection

A x B mm	Minimum $P_i > 5$ Pa		$p_t = 50$ Pa $L_{WA} = 30$ dB(A)		$p_t = 50$ Pa $L_{WA} = 35$ dB(A)	
	l/s	m <sup>3</sup> /h	l/s	m <sup>3</sup> /h	l/s	m <sup>3</sup> /h
300 - 100	12	42	23	83	28	101
400 - 150	22	78	-	-	40	144
500 - 150	34	122	37	133	60	216
500 - 200	38	138	-	-	79	284
500 - 300	38	137	83	299	107	385

#### WB-2 Side connection

A x B mm	Minimum $P_i > 5$ Pa		$p_t = 50$ Pa $L_{WA} = 30$ dB(A)		$p_t = 50$ Pa $L_{WA} = 35$ dB(A)	
	l/s	m <sup>3</sup> /h	l/s	m <sup>3</sup> /h	l/s	m <sup>3</sup> /h
300 - 100	10	37	21	76	27	97
400 - 150	22	81	34	122	43	155
500 - 150	28	102	-	-	57	205
500 - 200	34	122	62	223	76	274
500 - 300	46	165	-	-	-	-

### Throw $l_{0,2}$

The throw is specified at a terminal velocity of 0.2 m/s.

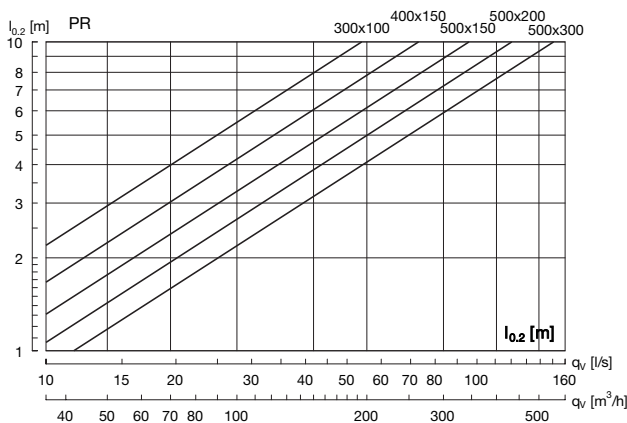

### Sound attenuation

The diffuser's sound attenuation function from duct to room, including end reflection - see table below.

#### WB-1 Back connection

A x B mm	Centre frequency Hz							
	63	125	250	500	1K	2K	4K	8K
300 - 100	25	18	14	7	9	10	8	11
400 - 150	21	20	7	6	9	7	6	8
500 - 150	19	19	7	8	7	9	9	10
500 - 200	18	16	5	10	8	13	10	11
500 - 300	15	12	3	12	8	11	9	10

#### WB-2 Side connection

A x B mm	Centre frequency Hz							
	63	125	250	500	1K	2K	4K	8K
300 - 100	26	17	11	7	9	12	10	11
400 - 150	21	17	4	9	7	11	10	10
500 - 150	19	18	5	8	7	9	9	10
500 - 200	18	13	5	8	10	11	12	13
500 - 300	15	10	5	6	11	12	11	10

#### VBA

Size	Centre frequency Hz							
	63	125	250	500	1K	2K	4K	8K
300x100	23	19	11	10	8	12	10	12
400x150	14	10	8	10	11	12	10	12
500x150	15	11	9	8	8	11	10	10
500x200	13	10	9	8	8	9	10	11

# Wall diffuser

# PR1

## Technical data

### Air jet dispersal

$l_b$  = Distance from the diffuser to the point where there is maximum dispersal.

$b_v$  = Depth of the air jet on a vertical plane.

$b_h$  = Width of the air jet on a horizontal plane.

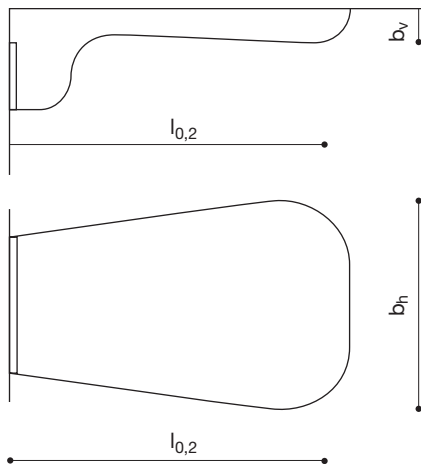

$l_{0,2}$ : Diagram value

$b_v$ :  $0.05 \times l_{0,2}$

$b_h$ :  $0.7 \times l_{0,2}$

### Pattern 1 - 4

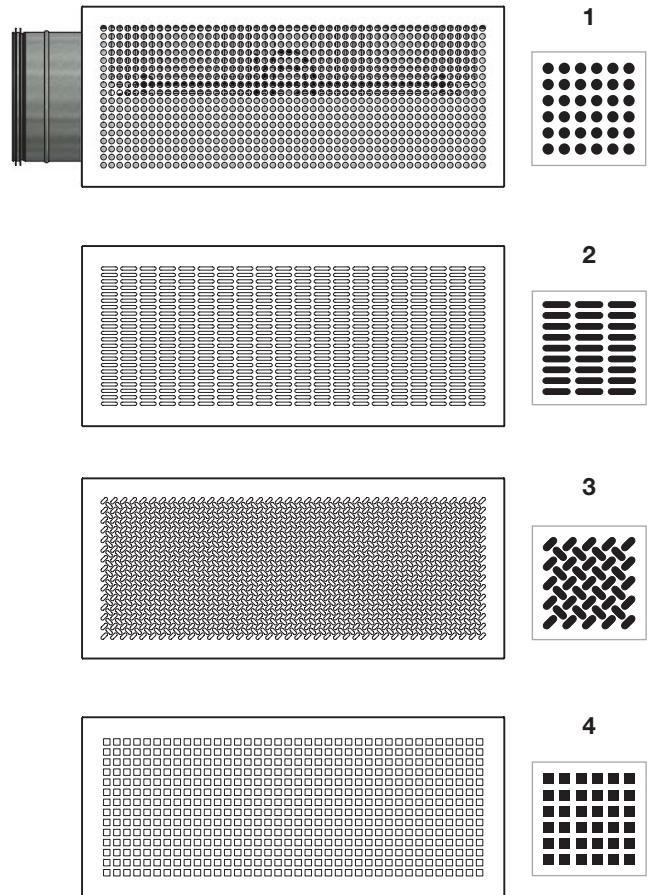

### WB Damper



1

2

3

4

5

6

7

8

9

10

11

12

13

14

15

16

17

18

# Wall diffuser

# PR1

## WB 1 - back connection

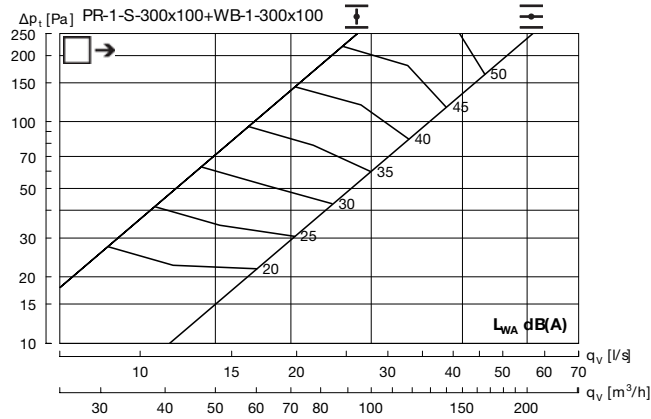

Hz	63	125	250	500	1K	2K	4K	8K
$K_{ok}$	0	-4	1	-1	-5	-14	-20	-25

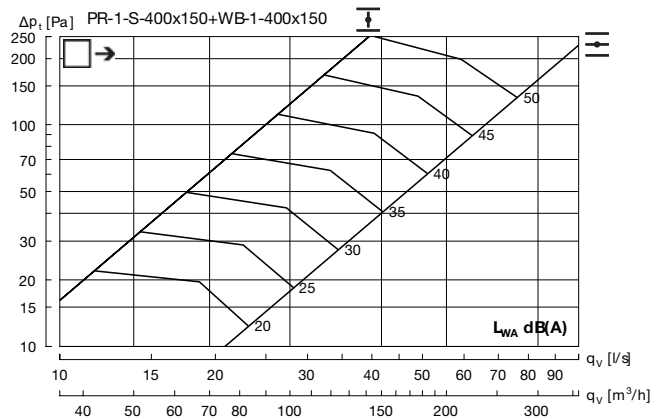

Hz	63	125	250	500	1K	2K	4K	8K
$K_{ok}$	7	-2	1	0	-6	-15	-20	-26

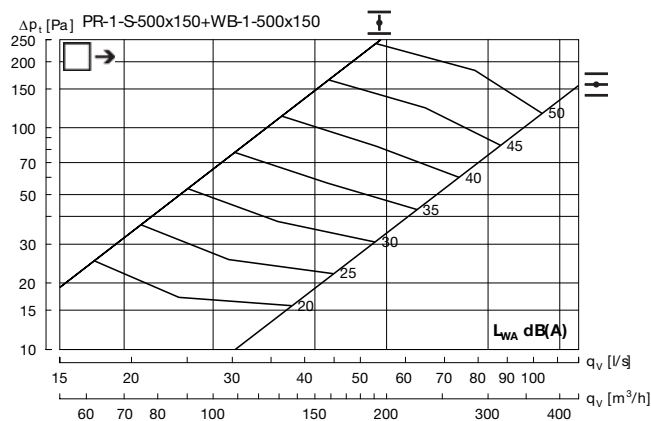

Hz	63	125	250	500	1K	2K	4K	8K
$K_{ok}$	3	-1	2	0	-7	-16	-23	-29

## WB 2 - side connection

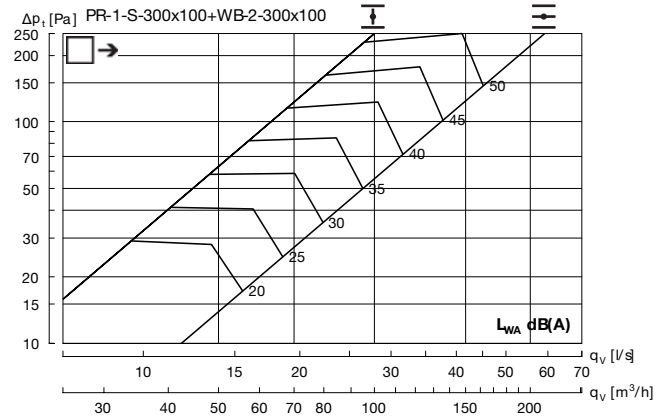

Hz	63	125	250	500	1K	2K	4K	8K
$K_{ok}$	3	-1	4	-2	-6	-17	-22	-22

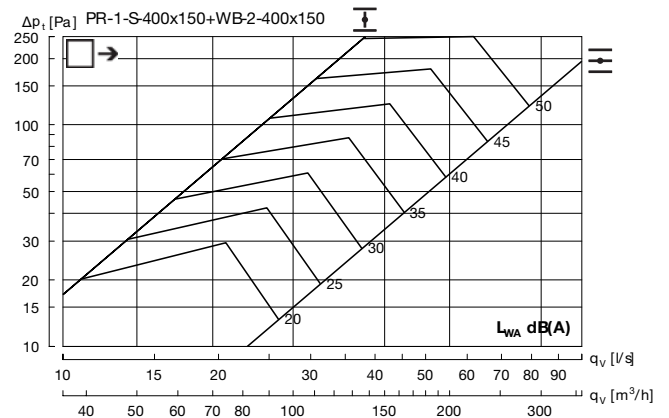

Hz	63	125	250	500	1K	2K	4K	8K
$K_{ok}$	-2	-1	1	-2	-3	-14	-20	-26

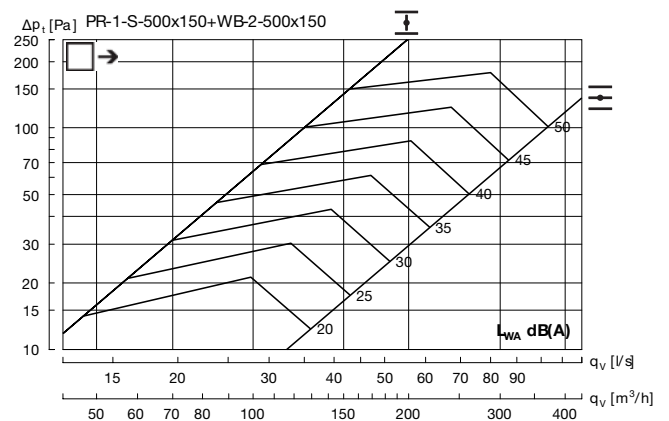

Hz	63	125	250	500	1K	2K	4K	8K
$K_{ok}$	8	-1	1	-1	-4	-15	-24	-32

# Wall diffuser

# PR1

## WB 1 - back connection

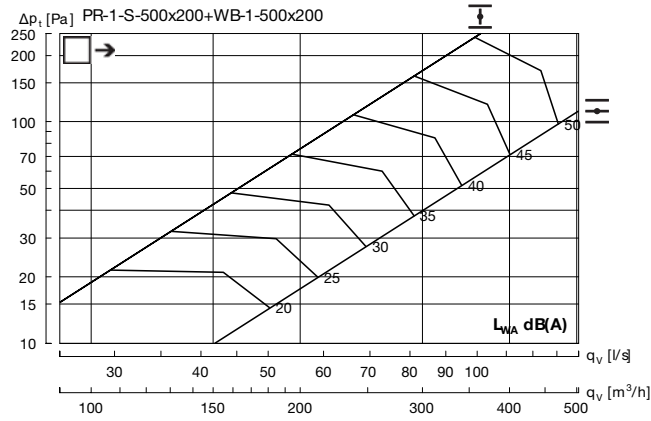

Hz	63	125	250	500	1K	2K	4K	8K
$K_{ok}$	0	-1	2	0	-6	-18	-23	-32

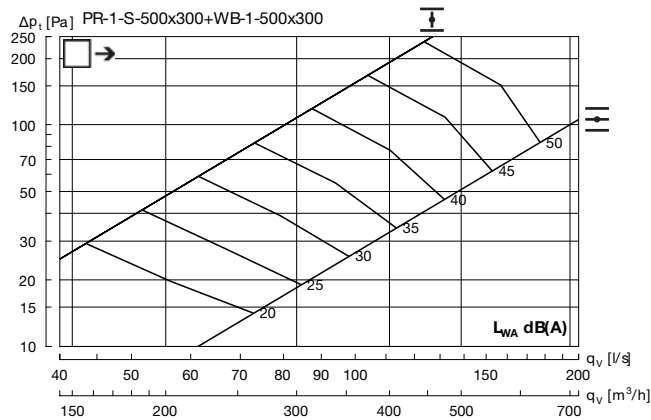

Hz	63	125	250	500	1K	2K	4K	8K
$K_{ok}$	6	2	3	0	-7	-16	-22	-30

## WB 2 - side connection

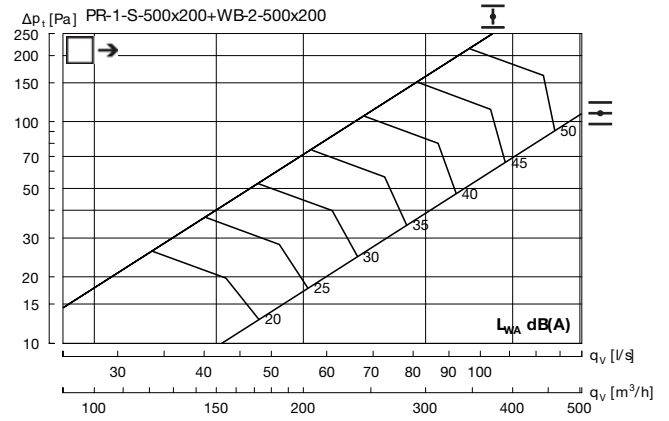

Hz	63	125	250	500	1K	2K	4K	8K
$K_{ok}$	-1	2	2	0	-6	-18	-23	-31

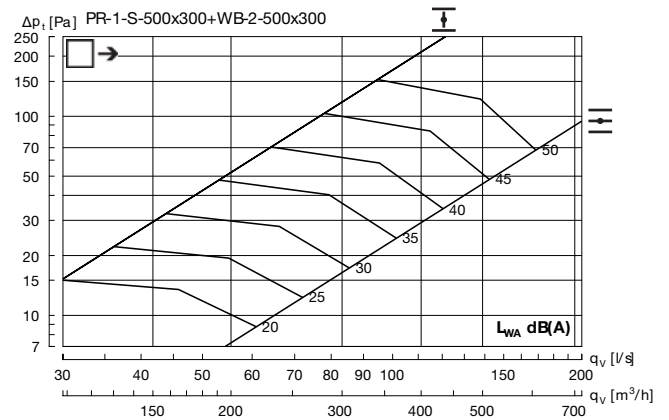

Hz	63	125	250	500	1K	2K	4K	8K
$K_{ok}$	1	2	-1	0	-4	-17	-26	-35

- 1
- 2
- 3
- 4
- 5
- 6
- 7
- 8
- 9
- 10
- 11
- 12
- 13
- 14
- 15
- 16
- 17
- 18

# Wall diffuser

# PR1

## VBA exhaust

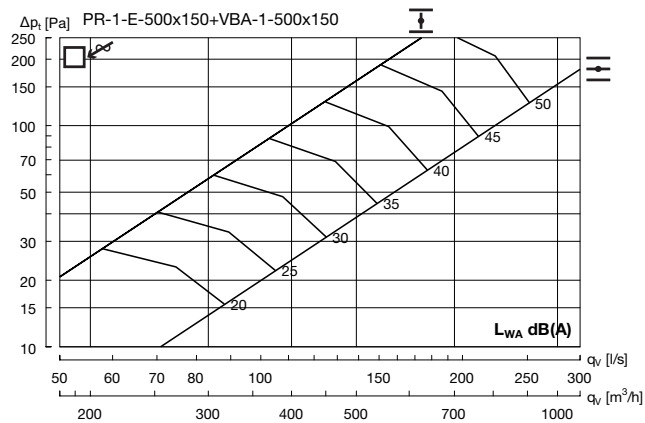
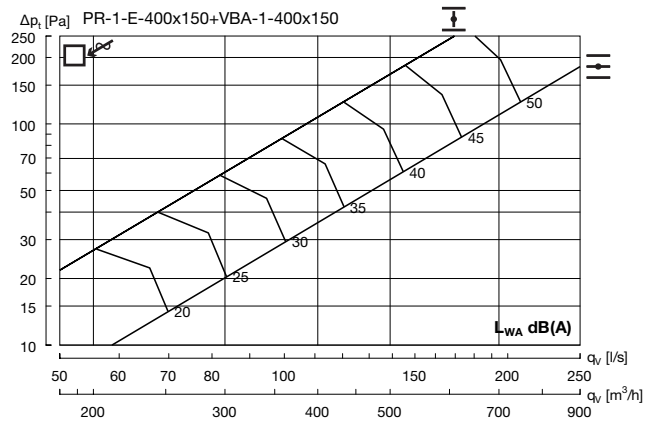
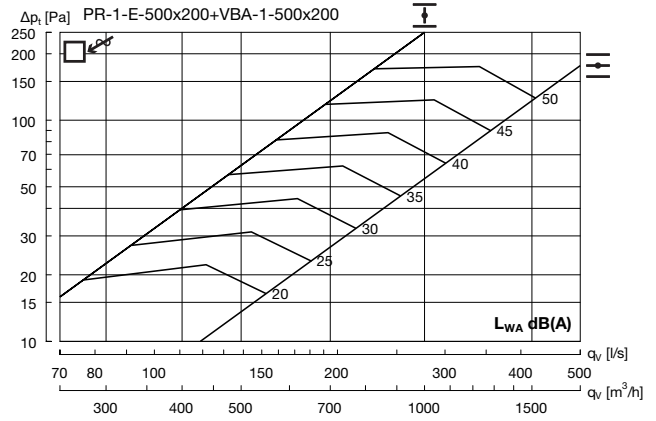
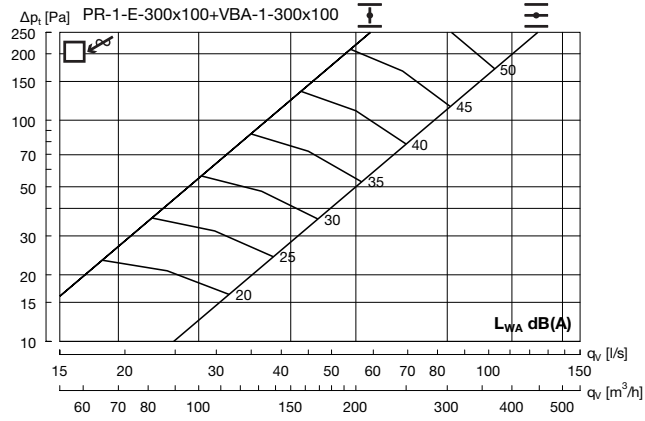

## Correction sound

Correction values for conversion of diagram data for connection from the side or top – see table below.

	PR + VBA-2 side	PR + VBA-4 Top
Open damper	+2 dB	+4 dB
50% Open damper	+1 dB	+1 dB
Closed damper	0 dB	0 dB

# Wall diffuser

# NR19



## Description

NR19 is a rectangular diffuser with adjustable nozzles suitable for installation in a wall or skirting board. The diffuser is suitable for the horizontal supply of cooled air. The nozzles at the front make it possible to vary the dispersal pattern and thereby create different throws. The diffuser is used with a WB type plenum box. The plenum boxes are equipped with a damper and measuring device, enabling individual adjustment.

- Individually adjustable nozzles
- Flexible dispersal pattern
- Regardless of straight ducting before the diffuser
- Telescopic function in the plenum box

## Maintenance

The front can be removed and the damper taken out for cleaning of internal parts or to gain access to the duct. The visible parts of the diffuser can be wiped with a damp cloth.

## Order code

<b>Product</b>	NR19	<b>S</b>	<b>A x B</b>
<b>Type</b>	NR19		
<b>Functional use</b>			
	S ( Supply air )		
<b>Size (A x B)</b>			
	300x100 - 500x300		

<b>Product</b>	WB	<b>a</b>	<b>A x B</b>
<b>Type</b>	WB		
<b>Connection</b>			
	1 = Back		
	2 = Side		
<b>Size (A x B)</b>			
	300x100 - 500x300		

Example: NR19-S-500x200 + WB-2-500x200

## Dimensions

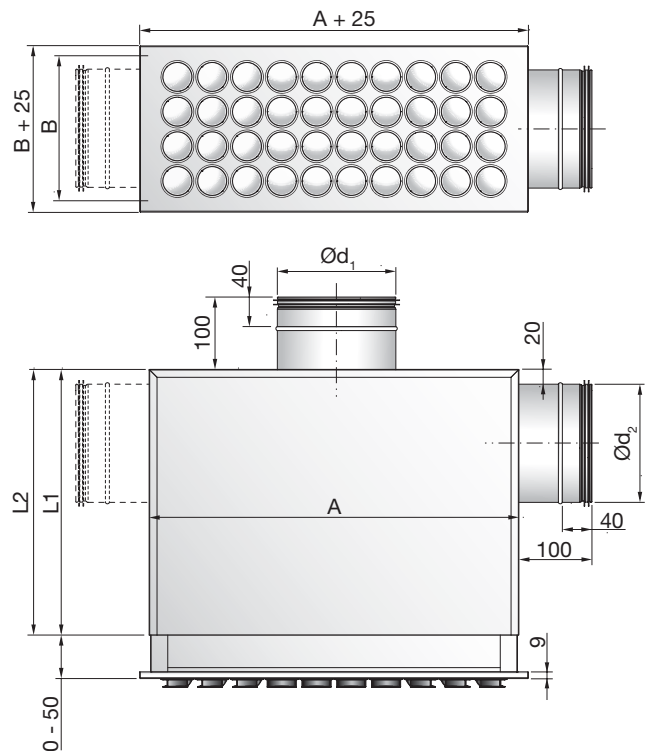

### WB-1 Back connection

A x B Size mm	Ød <sub>1</sub> mm	A mm	B mm	L1 mm	m kg
300 - 100	80	300	100	240	2,50
400 - 150	100	400	150	240	3,50
500 - 150	125	500	150	240	4,30
500 - 200	160	500	200	240	5,50
500 - 300	200	500	300	240	7,40

### WB-2 Side connection

A x B Size mm	Ød <sub>2</sub> mm	A mm	B mm	L2 mm	m kg
300 - 100	80	300	100	280	2,50
400 - 150	100	400	150	300	3,50
500 - 150	125	500	150	325	4,30
500 - 200	160	500	200	360	5,50
500 - 300	200	500	300	400	7,40

## Materials and finish

Diffuser:	Galvanised steel
Nozzles:	ABS plastic
Standard finish:	Powder-coated
Standard colour:	RAL 9010 white, gloss 30

The diffuser is available in other colours. Please contact Lindab's sales department for further information.

# Wall diffuser

# NR19

## Technical data

### Capacity

Volume flow  $q_v$  [l/s] and [m<sup>3</sup>/h], total pressure loss  $\Delta p_t$  [Pa], throw  $l_{0,2}$  and sound level  $L_{WA}$  [dB(A)] can be seen in the diagrams.

### Frequency-related sound effect level

The sound effect level in the frequency band is defined as  $L_{WOK} = L_{WA} + K_{OK}$ .  $K_{OK}$  values are specified in charts beneath the diagrams on the following pages.

### Quick selection

#### WB-1 Back connection

A x B mm	Minimum $P_t > 5$ Pa		$p_t = 50$ Pa $L_{WA}=30$ dB(A)		$p_t = 50$ Pa $L_{WA}=35$ dB(A)	
	l/s	m <sup>3</sup> /h	l/s	m <sup>3</sup> /h	l/s	m <sup>3</sup> /h
300 - 100	12	42	23	83	28	101
400 - 150	23	81	28	101	42	151
500 - 150	29	103	38	137	60	216
500 - 200	36	130	55	198	78	281
500 - 300	51	184	-	-	103	371

#### WB-2 Side connection

A x B mm	Minimum $P_t > 5$ Pa		$p_t = 50$ Pa $L_{WA}=30$ dB(A)		$p_t = 50$ Pa $L_{WA}=35$ dB(A)	
	l/s	m <sup>3</sup> /h	l/s	m <sup>3</sup> /h	l/s	m <sup>3</sup> /h
300 - 100	12	42	20	72	25	90
400 - 150	23	81	36	130	44	158
500 - 150	29	103	-	-	55	198
500 - 200	36	130	-	-	74	266
500 - 300	51	184	-	-	-	-

### Throw $l_{0,2}$

The throw is specified at a terminal velocity of 0.2 m/s.

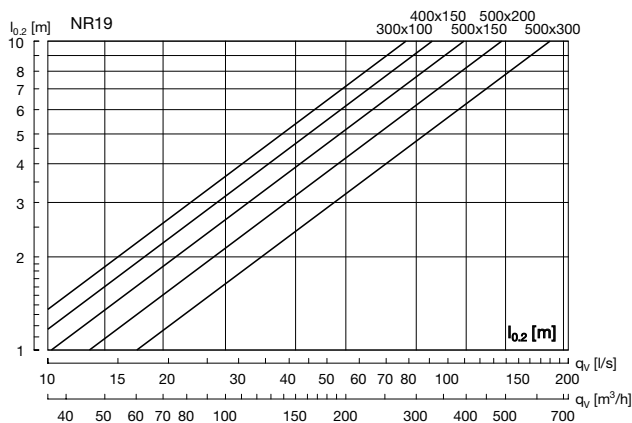

### Sound attenuation

The diffuser's sound attenuation function from duct to room, including end reflection - see table below.

#### WB-1 Back connection

A x B mm	Centre frequency Hz							
	63	125	250	500	1K	2K	4K	8K
300 - 100	27	19	14	7	8	9	9	14
400 - 150	22	20	7	6	9	8	9	12
500 - 150	20	18	7	9	7	7	8	12
500 - 200	18	15	4	9	7	7	8	12
500 - 300	15	12	2	10	6	7	7	9

#### WB-2 Side connection

A x B mm	Centre frequency Hz							
	63	125	250	500	1K	2K	4K	8K
300 - 100	26	17	11	8	9	11	9	12
400 - 150	22	17	5	8	6	8	9	12
500 - 150	18	17	5	8	7	6	8	11
500 - 200	19	13	3	7	7	7	9	10
500 - 300	15	10	3	2	8	7	8	10

### WB back and side connection



# Wall diffuser

# NR19

## Technical data

### Air jet dispersal

$l_b$  = Distance from the diffuser to the point where there is maximum dispersal.

$b_v$  = Depth of the air jet on a vertical plane.

$b_h$  = Width of the air jet on a horizontal plane.

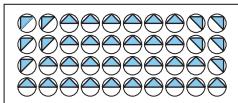
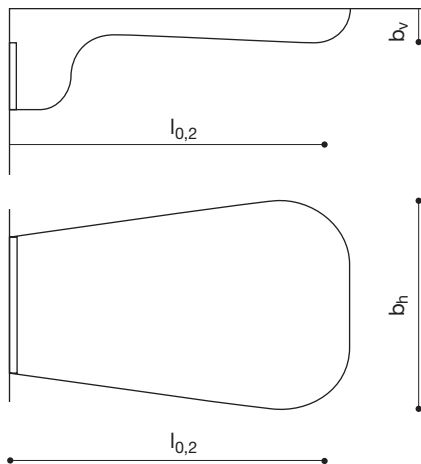

#### Normal nozzle setting

$l_{02}$ : Diagram value

$b_v$ :  $0.05 \times l_{0,2}$

$b_h$ :  $0.7 \times l_{0,2}$

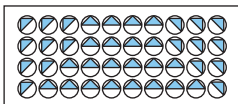

#### Short throw

$l_{02}$ :  $0.7 \times$  Diagram value

$b_v$ :  $0.05 \times l_{0,2}$

$b_h$ :  $0.85 \times l_{0,2}$

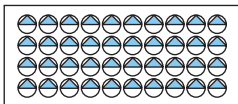

#### Long throw

$l_{02}$ :  $1.4 \times$  Diagram value

$b_v$ :  $0.05 \times l_{0,2}$

$b_h$ :  $0.5 \times l_{0,2}$



## WB Damper



1

2

3

4

5

6

7

8

9

10

11

12

13

14

15

16

17

18

# Wall diffuser

# NR19

## WB 1 - back connection

## WB 2 - side connection

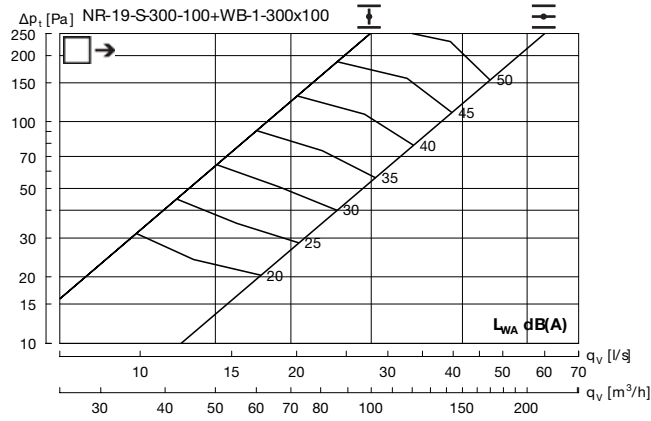

Hz	63	125	250	500	1K	2K	4K	8K
$K_{ok}$	13	-3	1	-1	-4	-14	-19	-26

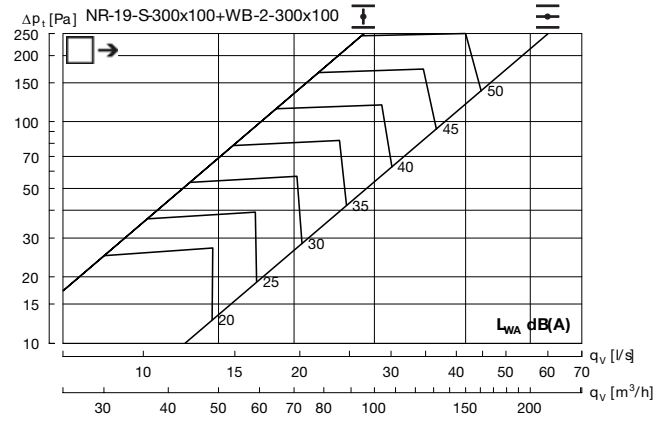

Hz	63	125	250	500	1K	2K	4K	8K
$K_{ok}$	3	0	4	-1	-6	-16	-21	-28

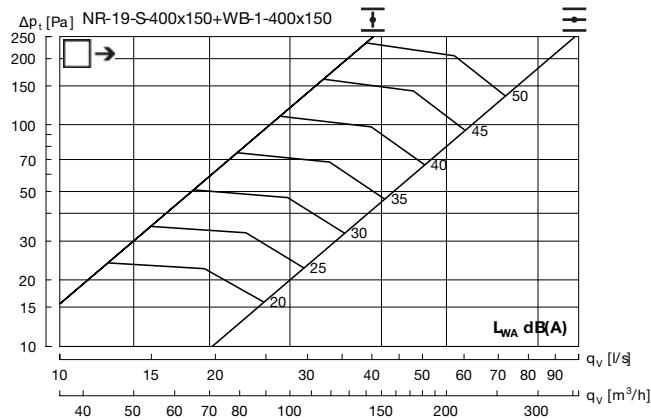

Hz	63	125	250	500	1K	2K	4K	8K
$K_{ok}$	2	0	1	0	-6	-14	-20	-27

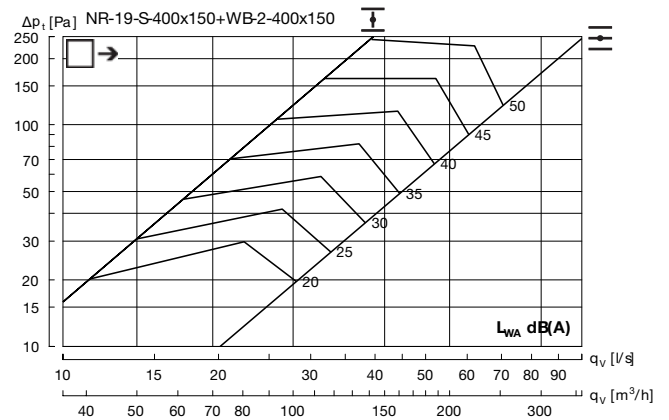

Hz	63	125	250	500	1K	2K	4K	8K
$K_{ok}$	4	2	2	-2	-5	-12	-20	-28

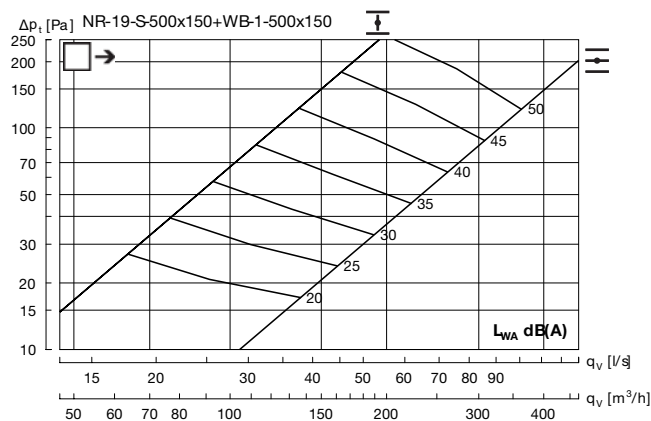

Hz	63	125	250	500	1K	2K	4K	8K
$K_{ok}$	5	-1	2	0	-7	-14	-21	-29

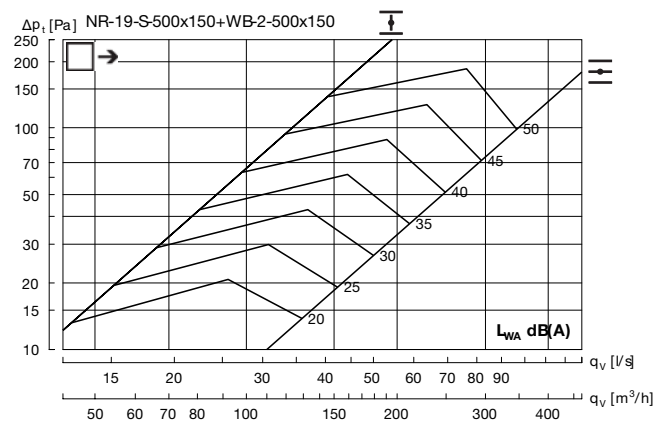

Hz	63	125	250	500	1K	2K	4K	8K
$K_{ok}$	5	1	0	-2	-4	-13	-22	-33

# Wall diffuser

# NR19

## WB 1 - back connection

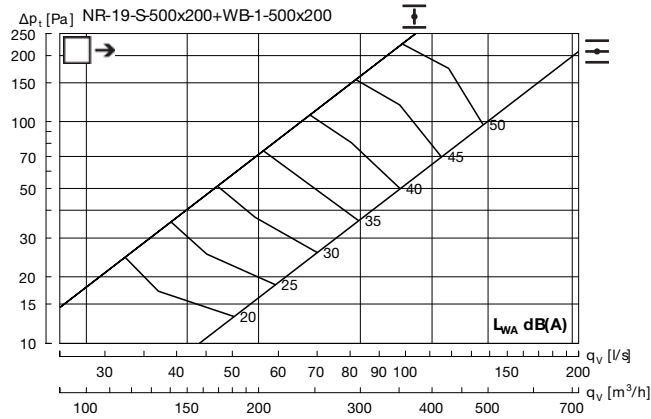

Hz	63	125	250	500	1K	2K	4K	8K
$K_{sk}$	4	-1	1	0	-6	-14	-21	-29

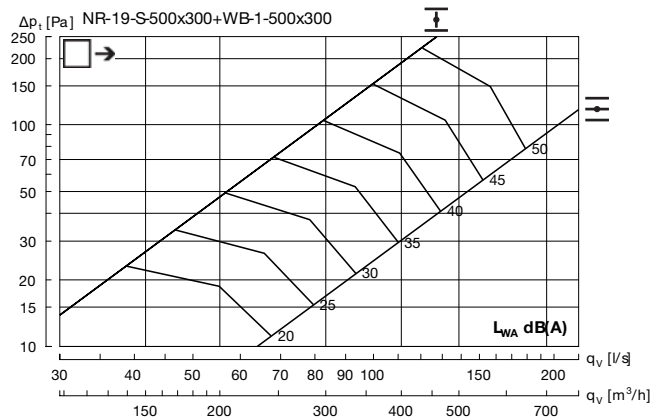

Hz	63	125	250	500	1K	2K	4K	8K
$K_{sk}$	7	2	2	0	-7	-14	-21	-31

## WB 2 - side connection

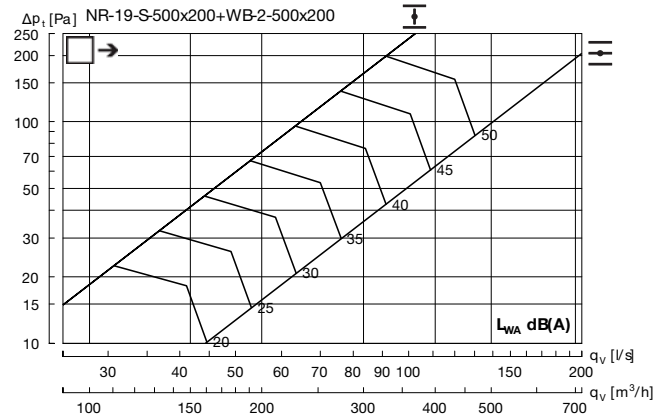

Hz	63	125	250	500	1K	2K	4K	8K
$K_{sk}$	1	2	3	-1	-6	-16	-23	-31

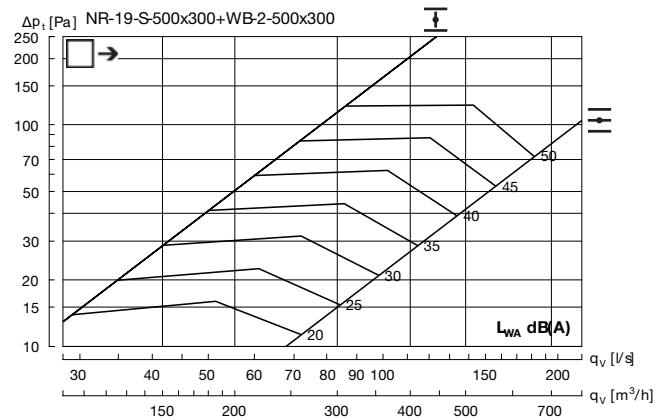

Hz	63	125	250	500	1K	2K	4K	8K
$K_{sk}$	1	3	0	-1	-4	-16	-26	-37

- 1
- 2
- 3
- 4
- 5
- 6
- 7
- 8
- 9
- 10
- 11
- 12
- 13
- 14
- 15
- 16
- 17
- 18

# Wall diffuser

# DR24



## Description

DR24 is a rectangular diffuser with adjustable bars suitable for installation in a wall or skirting board. The diffuser is suitable for the horizontal supply of cooled air. The bars in the front make it possible to vary the throw. The diffuser is used with a WB type plenum box. The plenum box is equipped with a damper and measuring device, enabling individual adjustment.

- Adjustable bars
- Flexible dispersal pattern
- Regardless of straight ducting before the diffuser
- Telescopic function in the plenum box

## Maintenance

The front can be removed and the damper taken out for cleaning of internal parts or to gain access to the duct. The visible parts of the diffuser can be wiped with a damp cloth.

## Order code

<b>Product</b>	<b>DR24</b>	<b>S</b>	<b>A x B</b>
<b>Type</b>	DR24		
<b>Functional use</b>		S (Supply air)	
<b>Size (A x B)</b>			300x100 - 500x300

<b>Product</b>	<b>WB</b>	<b>a</b>	<b>A x B</b>
<b>Type</b>	WB		
<b>Connection</b>		1 = Back 2 = Side	
<b>Size (A x B)</b>			300x100 - 500x300

Example: DR24-S-500x150 + WB-1-500x150

## Dimensions

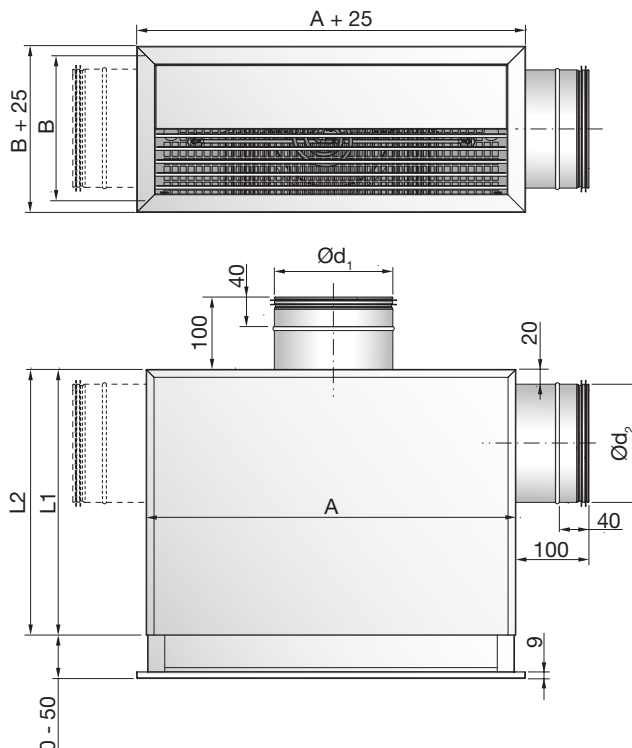

### WB-1 Back connection

A x B Size mm	Ød <sub>1</sub> mm	A mm	B mm	L1 mm	m kg
300 - 100	80	300	100	240	2,50
400 - 150	100	400	150	240	3,50
500 - 150	125	500	150	240	4,30
500 - 200	160	500	200	240	5,50
500 - 300	200	500	300	240	7,40

### WB-2 Side connection

A x B Size mm	Ød <sub>2</sub> mm	A mm	B mm	L2 mm	m kg
300 - 100	80	300	100	280	2,50
400 - 150	100	400	150	300	3,50
500 - 150	125	500	150	325	4,30
500 - 200	160	500	200	360	5,50
500 - 300	200	500	300	400	7,40

## Materials and finish

Diffuser: Galvanised steel  
 Standard finish: Powder-coated  
 Standard colour: RAL 9010 white, gloss 30

The diffuser is available in other colours. Please contact Lindab's sales department for further information.

# Wall diffuser

# DR24

## Technical data

### Capacity

Volume flow  $q_v$  [l/s] and [m<sup>3</sup>/h], total pressure loss  $\Delta p_t$  [Pa], throw  $l_{0,2}$  and sound level  $L_{WA}$  [dB(A)] can be seen in the diagrams.

### Frequency-related sound effect level

The sound effect level in the frequency band is defined as  $L_{WOK} = L_{WA} + K_{OK}$ .  $K_{OK}$  values are specified in charts beneath the diagrams on the following pages.

### Quick selection

#### WB-1 Back connection

A x B mm	Minimum $P_t > 5$ Pa		$p_t = 50$ Pa $L_{WA} = 30$ dB(A)		$p_t = 50$ Pa $L_{WA} = 35$ dB(A)	
	l/s	m <sup>3</sup> /h	l/s	m <sup>3</sup> /h	l/s	m <sup>3</sup> /h
300 - 100	16	58	-	-	29	104
400 - 150	33	119	-	-	38	137
500 - 150	44	158	-	-	60	216
500 - 200	50	180	62	223	86	310
500 - 300	61	221	84	302	109	392

#### WB-2 Side connection

A x B mm	Minimum $P_t > 5$ Pa		$p_t = 50$ Pa $L_{WA} = 30$ dB(A)		$p_t = 50$ Pa $L_{WA} = 35$ dB(A)	
	l/s	m <sup>3</sup> /h	l/s	m <sup>3</sup> /h	l/s	m <sup>3</sup> /h
300 - 100	14	49	20	72	26	94
400 - 150	29	106	39	140	50	180
500 - 150	35	126	-	-	56	202
500 - 200	47	169	-	-	83	299
500 - 300	56	200	-	-	-	-

### Throw $l_{0,2}$

The throw is specified at a terminal velocity of 0.2 m/s.

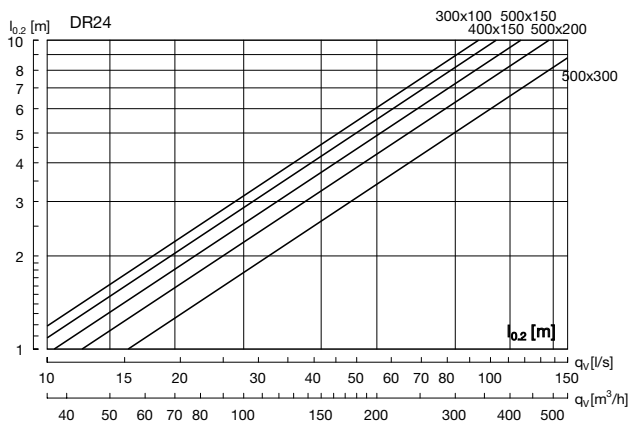

### Sound attenuation

The diffuser's sound attenuation function from duct to room, including end reflection - see table below

#### WB-1 Back connection

A x B mm	Centre frequency Hz							
	63	125	250	500	1K	2K	4K	8K
300 - 100	24	18	14	7	9	11	11	12
400 - 150	21	19	7	6	9	11	11	11
500 - 150	20	19	7	9	8	10	10	10
500 - 200	17	15	5	10	8	12	10	10
500 - 300	15	12	4	13	9	11	10	10

#### WB-2 Side connection

A x B mm	Centre frequency Hz							
	63	125	250	500	1K	2K	4K	8K
300 - 100	22	17	11	8	10	13	11	11
400 - 150	21	16	5	9	8	12	11	11
500 - 150	19	18	5	8	8	10	10	10
500 - 200	18	13	3	9	11	6	8	7
500 - 300	15	10	4	4	12	12	11	11

# Wall diffuser

DR24

## Technical data

### Air jet dispersal

$l_b$  = Distance from the diffuser to the point where there is maximum dispersal.

$b_v$  = Depth of the air jet on a vertical plane.

$b_h$  = Width of the air jet on a horizontal plane.

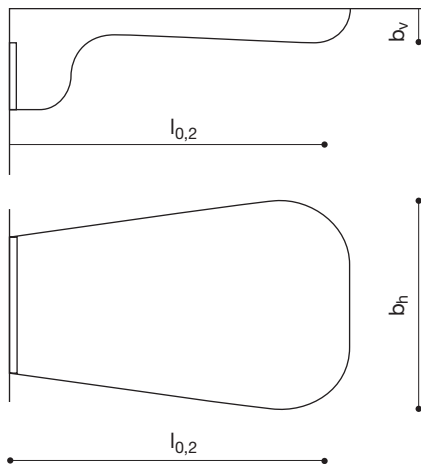

### Normal throw 45° upwards

$l_{0,2}$ : Diagram value

$b_v$ :  $0.05 \times l_{0,2}$

$b_h$ :  $1.8 \times l_{0,2}$

### Long throw 0°

$l_{0,2}$ :  $1.5 \times$  Diagram value

$b_v$ :  $0.1 \times l_{0,2}$

$b_h$ :  $0.5 \times l_{0,2}$

### WB Damper



# Wall diffuser

# DR24

## WB 1 - back connection

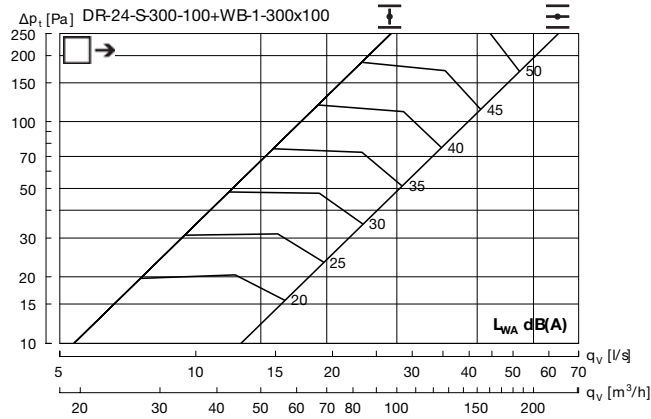

Hz	63	125	250	500	1K	2K	4K	8K
$K_{ok}$	3	-5	1	-1	-4	-14	-23	-27

## WB 2 - side connection

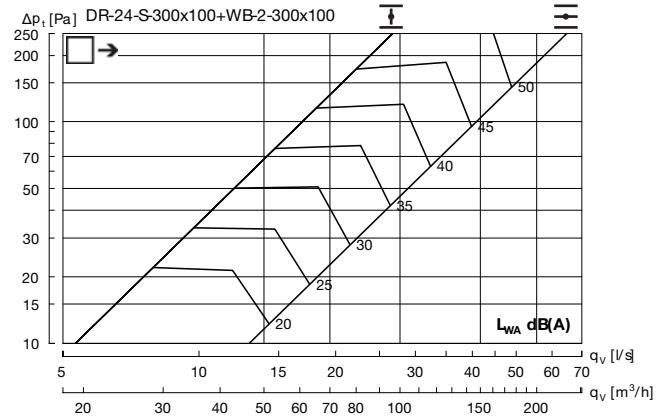

Hz	63	125	250	500	1K	2K	4K	8K
$K_{ok}$	-2	1	4	-1	-6	-17	-22	-26

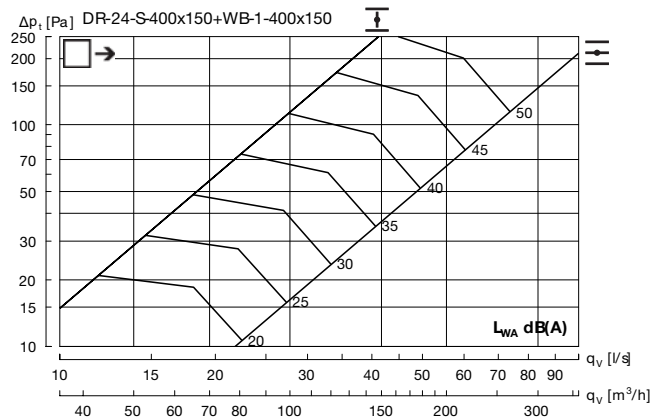

Hz	63	125	250	500	1K	2K	4K	8K
$K_{ok}$	7	-1	1	0	-6	-17	-20	-26

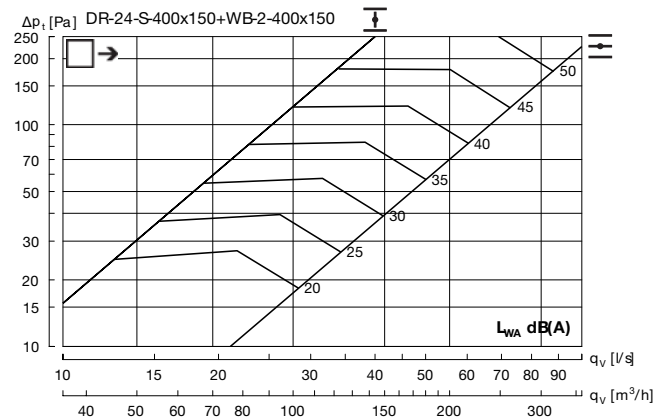

Hz	63	125	250	500	1K	2K	4K	8K
$K_{ok}$	1	3	2	-1	-6	-14	-20	-25

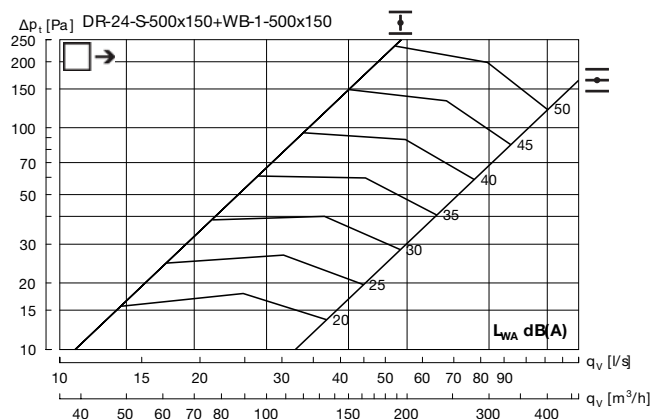

Hz	63	125	250	500	1K	2K	4K	8K
$K_{ok}$	0	-1	2	1	-8	-15	-21	-28

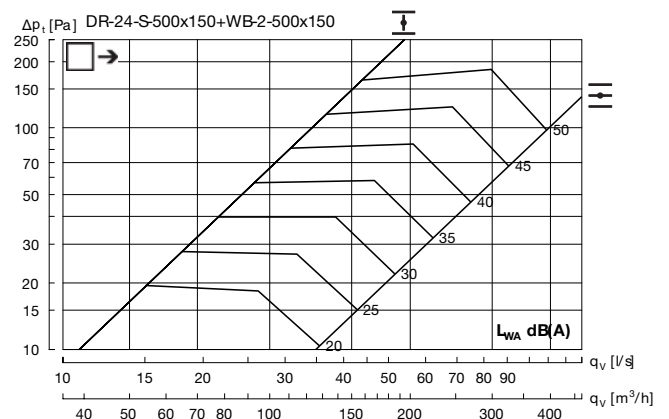

Hz	63	125	250	500	1K	2K	4K	8K
$K_{ok}$	2	0	-1	-2	-3	-13	-22	-32



# Wall diffuser

# DR24

## WB 1 - back connection

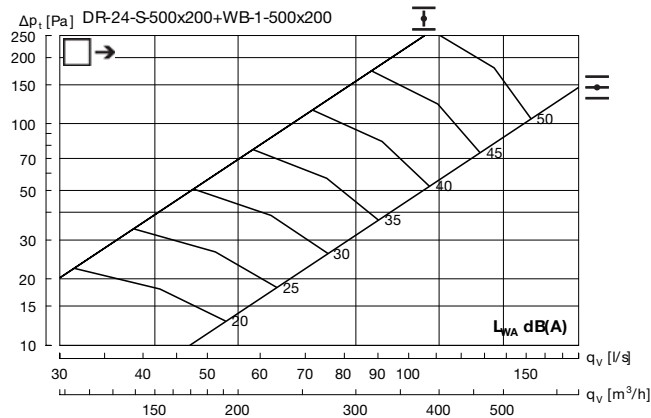

Hz	63	125	250	500	1K	2K	4K	8K
$K_{ok}$	4	2	1	0	-7	-18	-23	-31

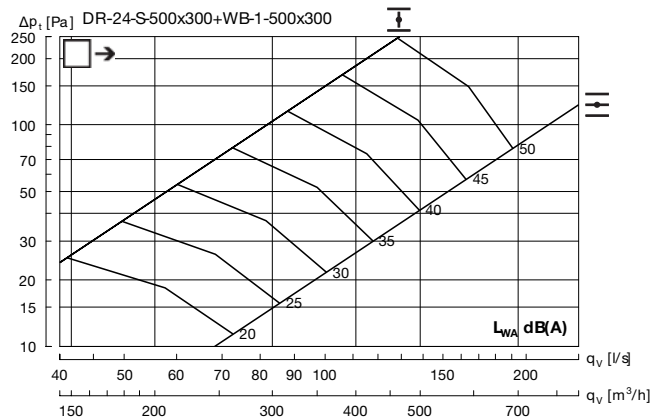

Hz	63	125	250	500	1K	2K	4K	8K
$K_{ok}$	2	2	2	0	-7	-16	-22	-30

## WB 2 - side connection

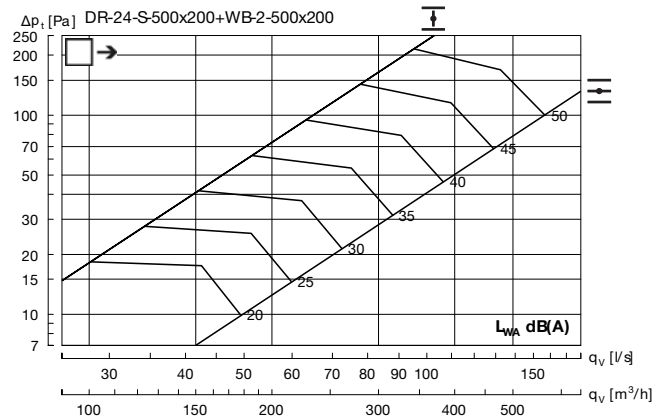

Hz	63	125	250	500	1K	2K	4K	8K
$K_{ok}$	-1	2	0	-1	-4	-18	-23	-31

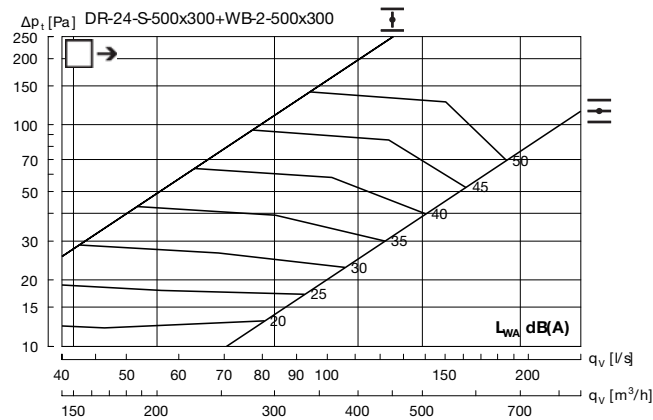

Hz	63	125	250	500	1K	2K	4K	8K
$K_{ok}$	3	2	-2	0	-4	-17	-28	-37

# Wall grille

# B3020



## Description

B3020 is a rectangular aluminium grille with fixed horizontal bars. B3020 can be used for supply air and exhaust. B3020 is supplied as standard with springs for installation in plenum boxes type VBA, WB. In the product photo the grille is shown with a VBA box.

## Maintenance

The grille should be removed to gain access to the plenum box or duct. The external parts should be wiped with a damp cloth.

## Dimensions

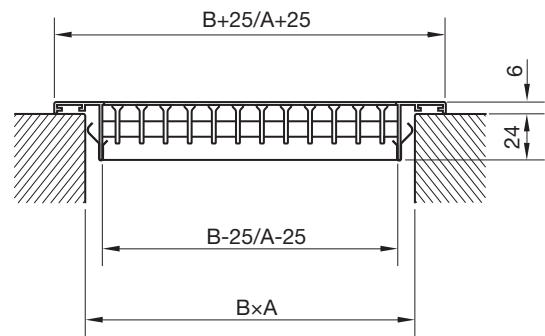

A x B mm	Free area F (m <sup>2</sup> )	Weight kg
200 x 100	0,0072	0,3
300 x 100	0,0113	0,4
400 x 100	0,0155	0,5
500 x 100	0,0195	0,7
300 x 150	0,0189	0,6
400 x 150	0,0258	0,7
500 x 150	0,0326	1,0
600 x 150	0,0395	1,2
400 x 200	0,0361	0,8
500 x 200	0,0457	1,4
600 x 200	0,0553	1,6

## Ordering example

<b>Product</b>	<b>B3020</b>	<b>aaa</b>	<b>bbb</b>
Type			
A - Measure			
B - Measure			

## Materials and finish

Grille: Aluminium  
 Standard finish: Natural anodized  
 On request: RAL 9010, gloss 30

The grille is available in other colours. Please contact Lindab's sales department for further information.



# Wall grille

# B3020

## Dimensions

1:

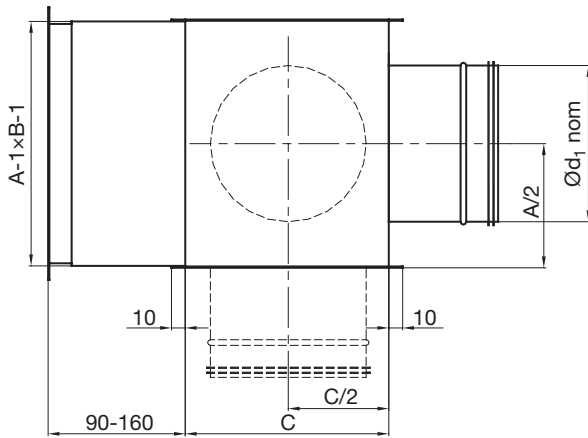

2:

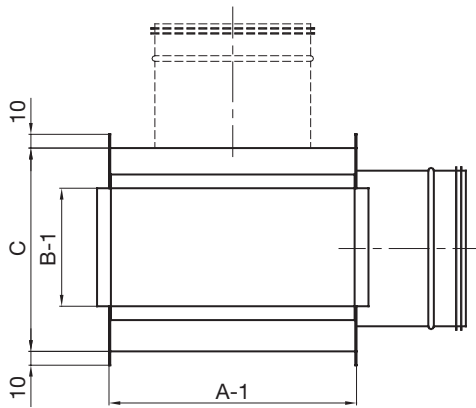

4:

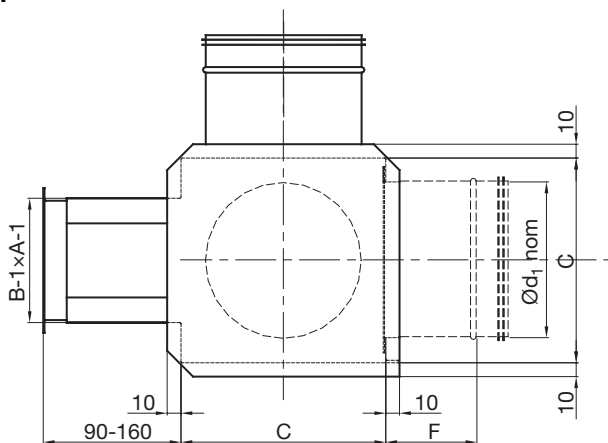

A x B mm	Ød <sub>1</sub> nom mm	C mm	F mm
200 x 100	125	165	90
300 x 100	160	200	110
300 x 150	200	240	130
400 x 100	160	200	110
400 x 150	250	290	155
400 x 200	250	290	155
500 x 100	200	240	130
500 x 150	250	290	155
500 x 200	315	355	190
600 x 150	250	290	155
600 x 200	315	355	190

## Ordering example

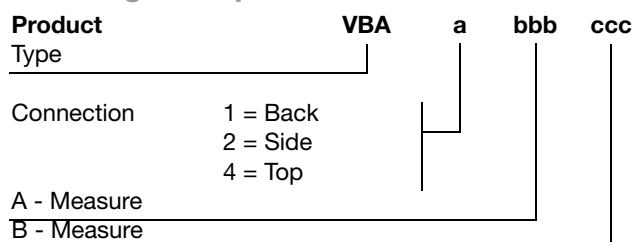

# Wall grille

# B3020

## Technical data

### Capacity

Volume flow  $q_v$  [l/s] and [m<sup>3</sup>/h], total pressure loss  $\Delta p_t$  [Pa], throw  $l_{0,2}$  [m] and sound level  $L_{WA}$  [dB(A)] can be seen in the diagrams.

### Frequency-related sound effect level

The sound effect level in the frequency band is defined as  $L_{WOK} = L_{WA} + K_{ok}$ .  $K_{ok}$  values are given in chart. See table below.

Supply air Size.	Centre frequency Hz							
	63	125	250	500	1K	2K	4K	8K
Open damper	-2	-3	-3	-3	-4	-7	-18	-24
50 % open damper	-1	1	-2	-3	-4	-8	-17	-22
Closed damper	-2	0	-3	-3	-7	-9	-8	-10

Exhaust Size.	Centre frequency Hz							
	63	125	250	500	1K	2K	4K	8K
Open damper	-6	-2	1	-2	-5	-11	-18	-22
50 % open damper	-5	0	1	-2	-4	-12	-20	-23
Closed damper	-11	-2	0	-4	-6	-12	-8	-9

### Throw $l_{0,2}$

Throw  $l_{0,2}$  [m] at an average speed of 0.2 m/s, 0° bar setting without ceiling effect (distance from diffuser to grille over 800 mm) can be seen in the diagrams. Correction for dispersal - see table below.

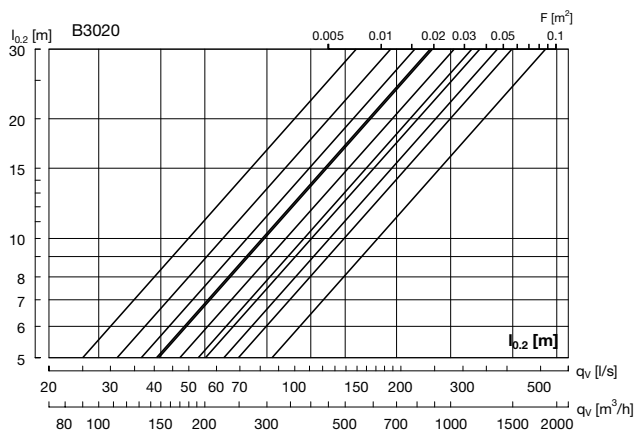

### Correction of throw

Bar setting	45°	90°
Correction factor	0,8	0,5

### Sound attenuation

The diffuser's sound attenuation function from duct to room, including end reflection - see table below (incl. VBA).

Size	Centre frequency Hz							
	63	125	250	500	1K	2K	4K	8K
200x100	25	20	12	10	6	12	12	12
300x150	16	12	8	10	10	11	11	12
300x100	23	19	11	10	8	12	10	12
400x150	14	10	8	10	11	12	10	12
400x200	15	12	9	8	8	11	12	12
400x100	21	17	10	10	8	11	11	12
500x200	13	10	9	8	8	9	10	11
500x150	15	11	9	8	8	11	10	10
500x100	20	16	9	9	8	13	11	11
600x200	13	10	9	8	8	9	11	11
600x150	14	10	8	9	8	10	10	11

### Correction sound

Correction values for conversion of diagram data for connection from the side or top – see table below.

	B3020 + VBA-2 side	B3020 + VBA-4 Top
Open damper	+2 dB	+4 dB
50% Open damper	+1 dB	+1 dB
Closed damper	0 dB	0 dB



# Wall grille

# B3020

## Technical data

### Air jet dispersal

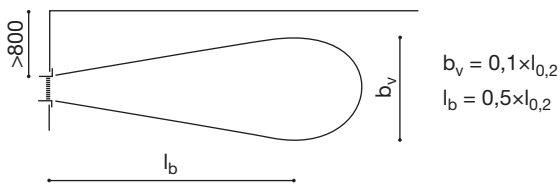
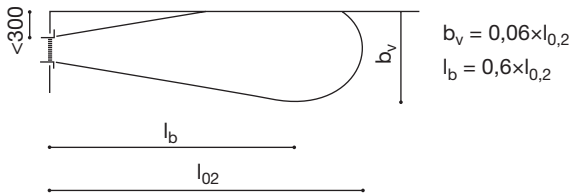

1

2

3

4

5

6

7

8

9

10

11

12

13

14

15

16

17

18

# Wall grille

# B3020

## Technical data

### Supply air

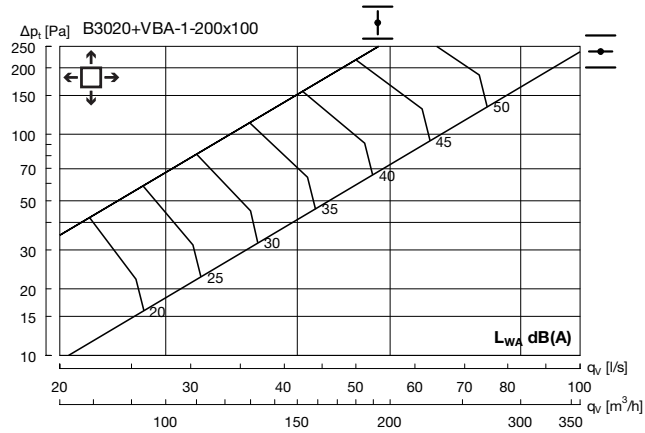

### Exhaust air

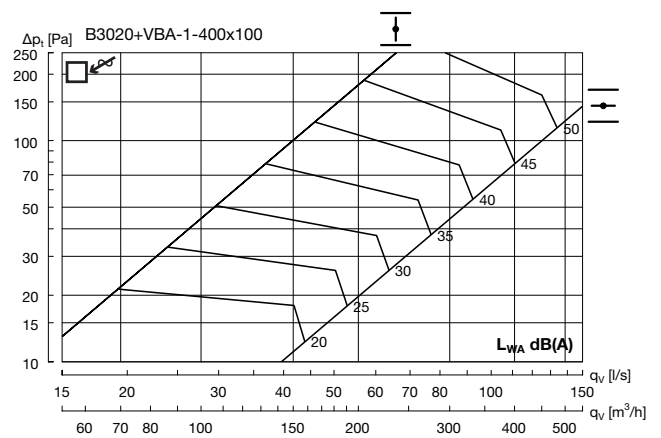
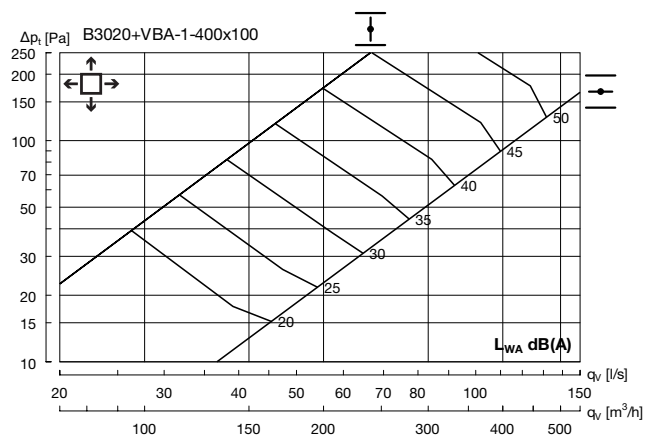
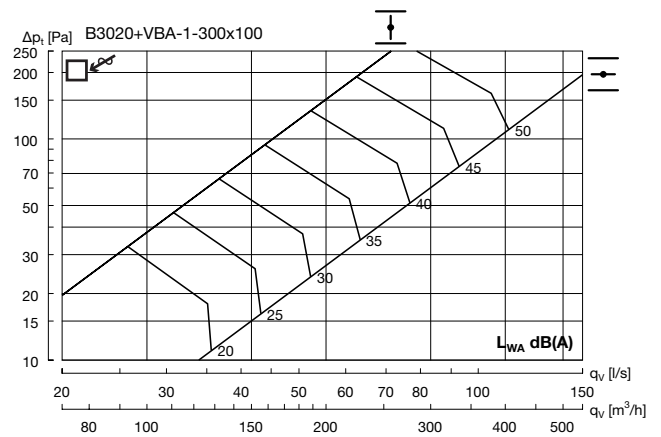
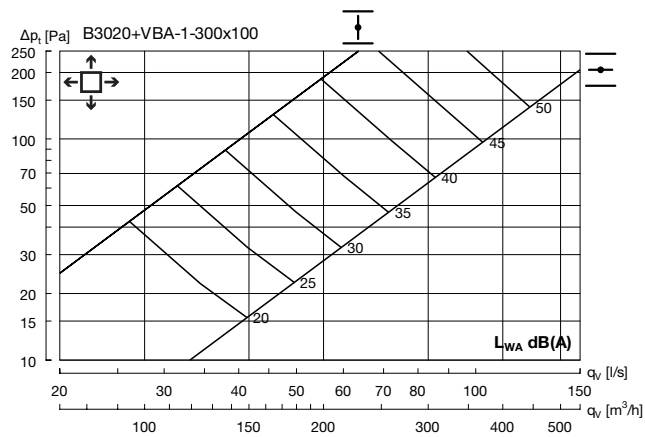
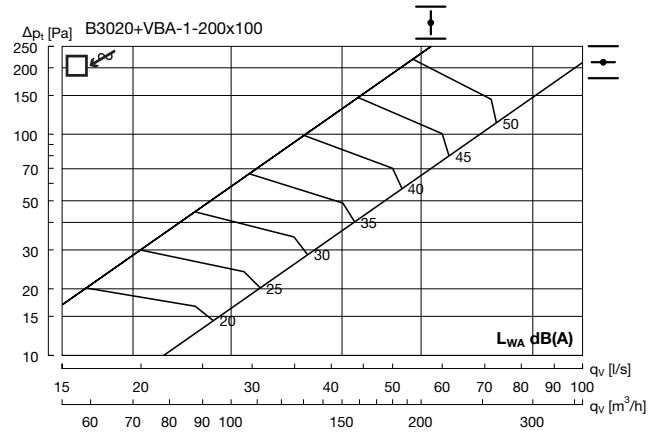

- 1
- 2
- 3
- 4
- 5
- 6
- 7
- 8
- 9
- 10
- 11
- 12
- 13
- 14
- 15
- 16
- 17
- 18

# Wall grille

# B3020

## Technical data

### Supply air

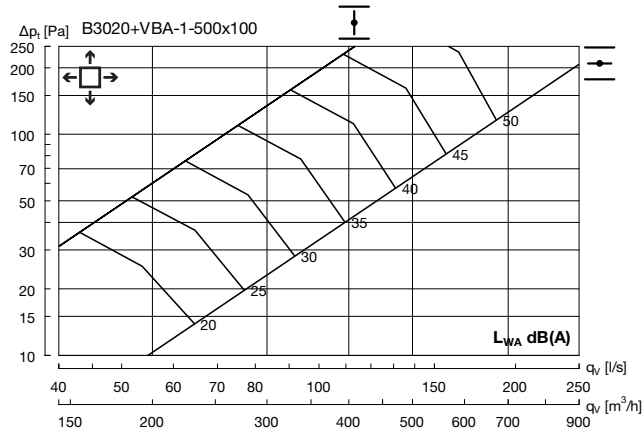

### Exhaust air

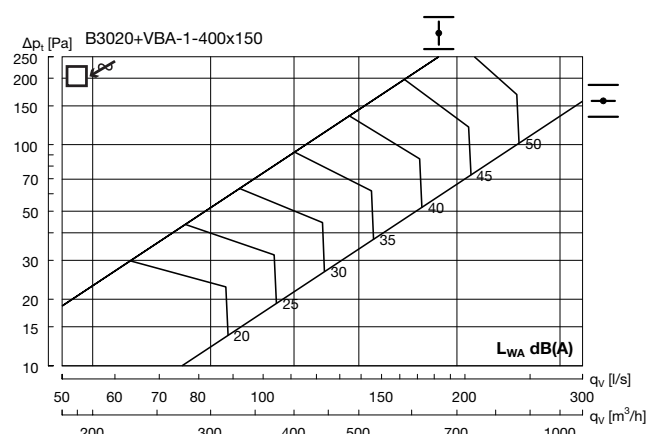
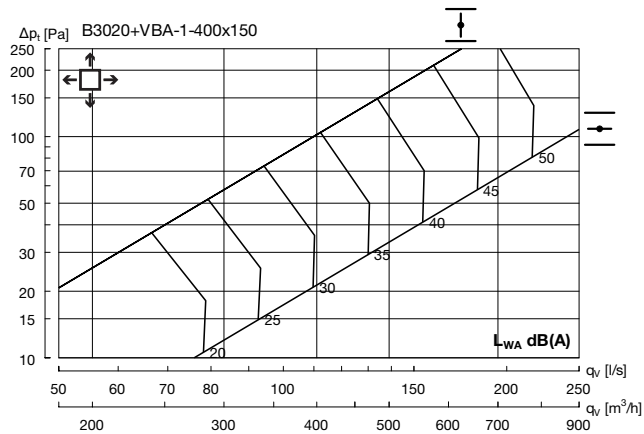
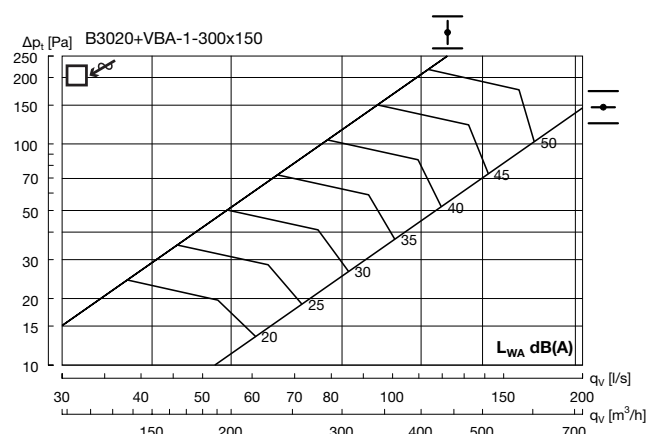
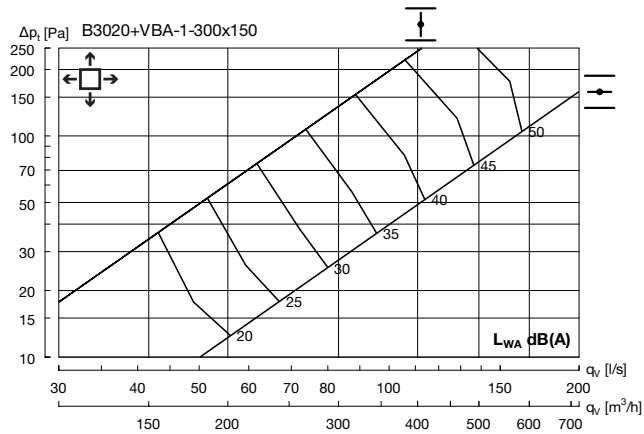
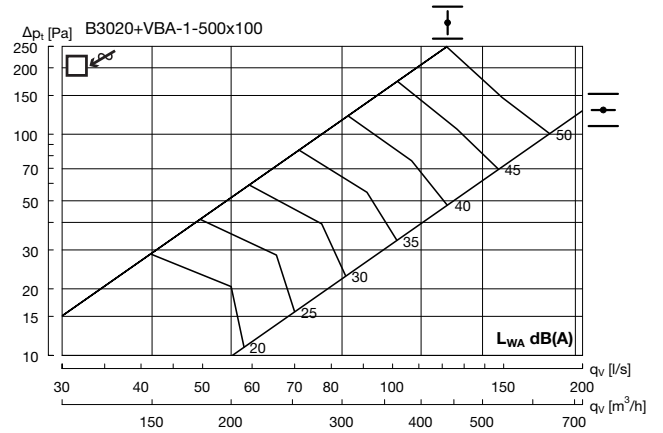

# Wall grille

# B3020

## Technical data

### Supply air

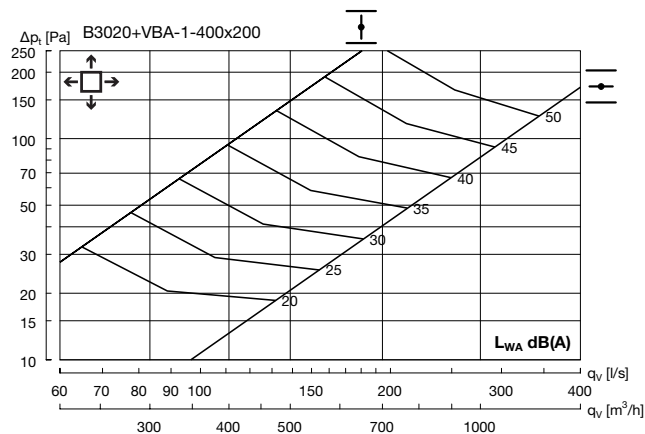
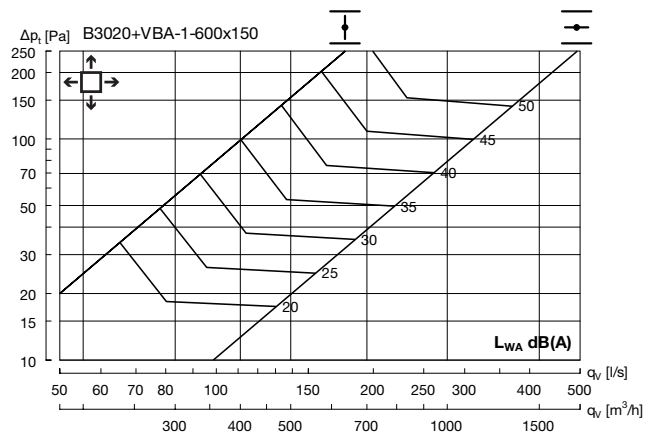
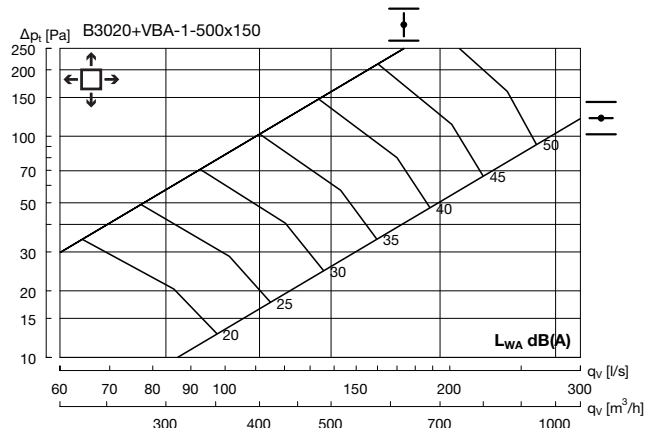

### Exhaust air

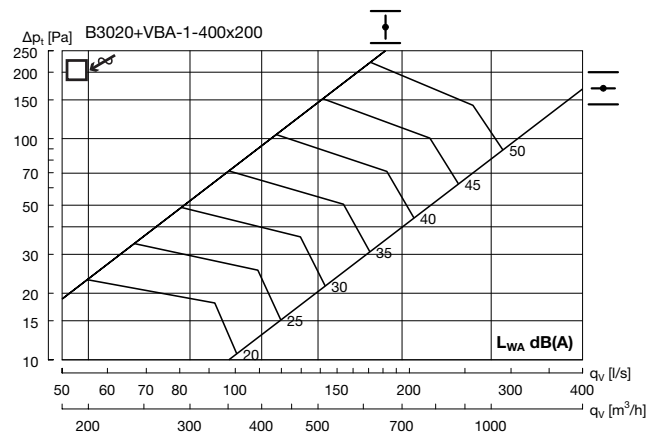
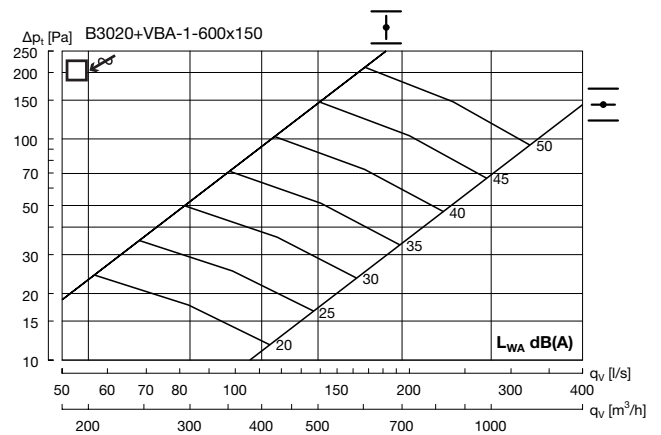
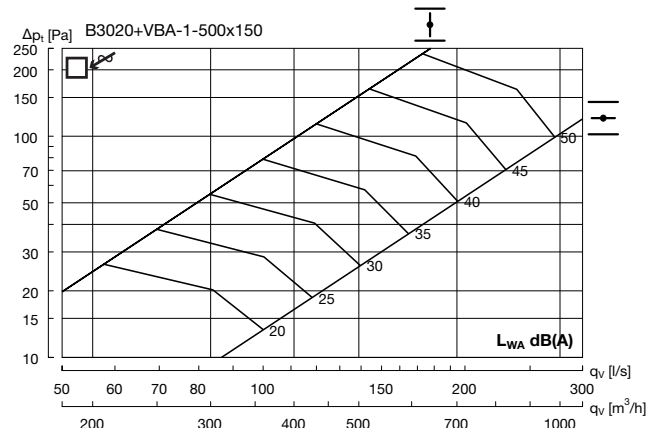

- 1
- 2
- 3
- 4
- 5
- 6
- 7
- 8
- 9
- 10
- 11
- 12
- 13
- 14
- 15
- 16
- 17
- 18

# Wall grille

# B3020

## Technical data

### Supply air

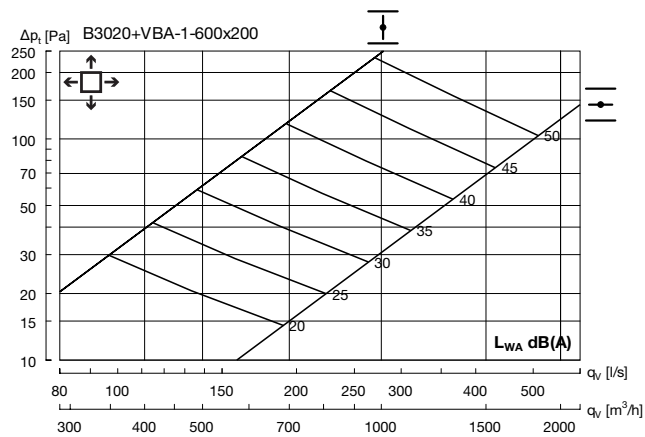
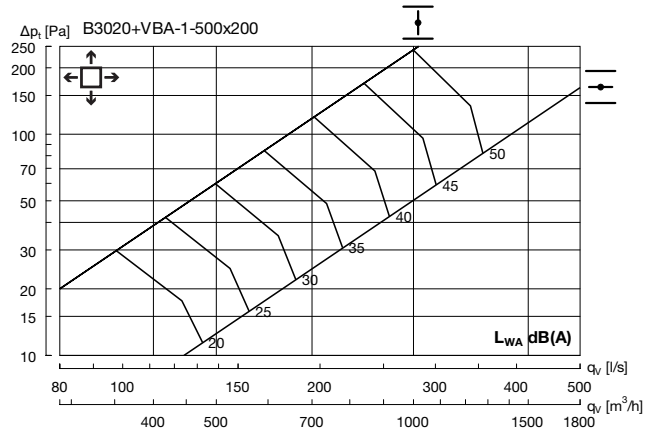

### Exhaust air

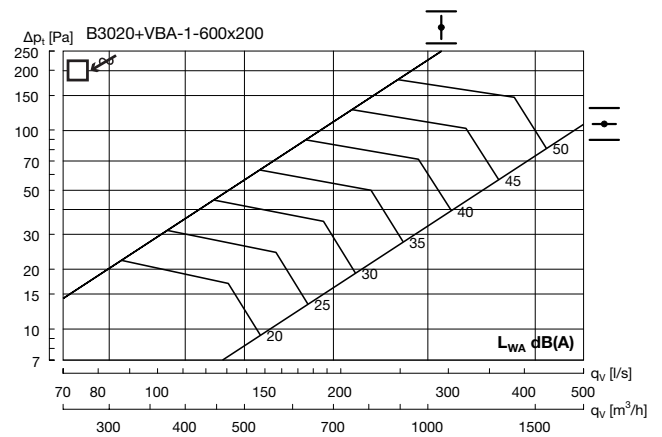
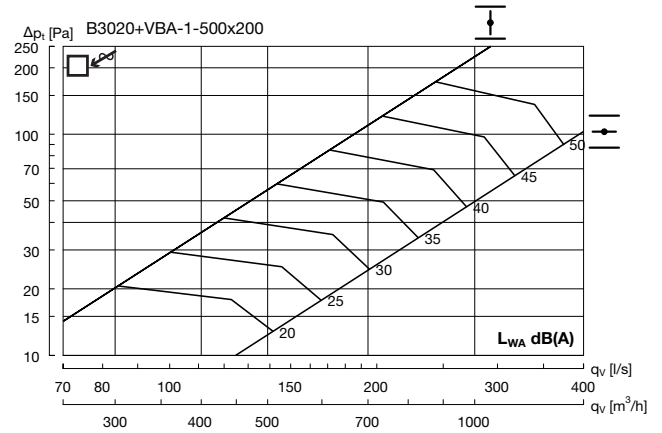

# Wall grille

# C20/C21



## Description

C20 is a rectangular aluminium grille with adjustable horizontal bars. C21 is also equipped with vertical directional bars for regulation of dispersal patterns. C20/C21 can be used for supply air and come as standard with springs for installation in plenum boxes type VBA and WB. In the product photo the grille is shown with a VBA box.

## Maintenance

The grille should be removed to gain access to the plenum box or duct. The external parts should be wiped with a damp cloth.

## Ordering example

<b>Product</b>	<b>C20/C21</b>	<b>aaa</b>	<b>bbb</b>
Type			
A - Measure			
B - Measure			

## Dimensions

### C20

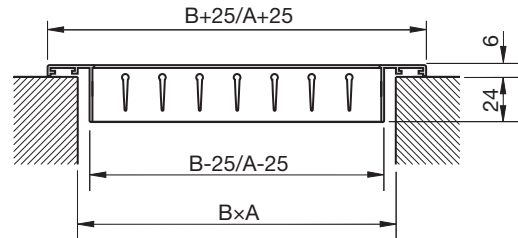

### C21

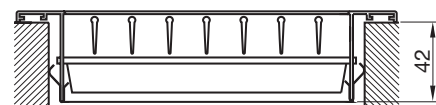

A x B mm	Free area F(m <sup>2</sup> )	Weight kg
200 x 100	0,0105	0,3
300 x 100	0,0164	0,4
400 x 100	0,0225	0,5
500 x 100	0,0283	0,7
300 x 150	0,0275	0,6
400 x 150	0,0375	0,7
500 x 150	0,0475	1,0
600 x 150	0,0574	1,2
400 x 200	0,0525	0,9
500 x 200	0,0664	1,4
600 x 200	0,0804	1,6

## Materials and finish

Grille: Aluminium  
 Standard finish: Natural anodized  
 On request: RAL 9010, gloss 30

The grille is available in other colours. Please contact Lindab's sales department for further information.

# Wall grille

# C20/C21

## Dimensions

1:

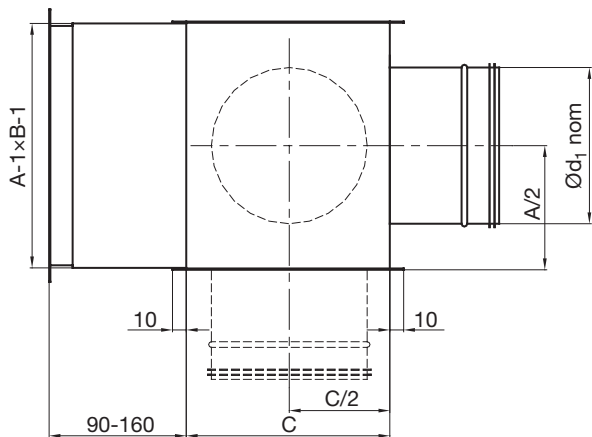

2:

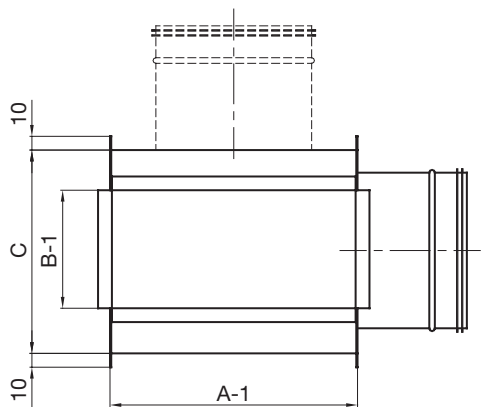

4:

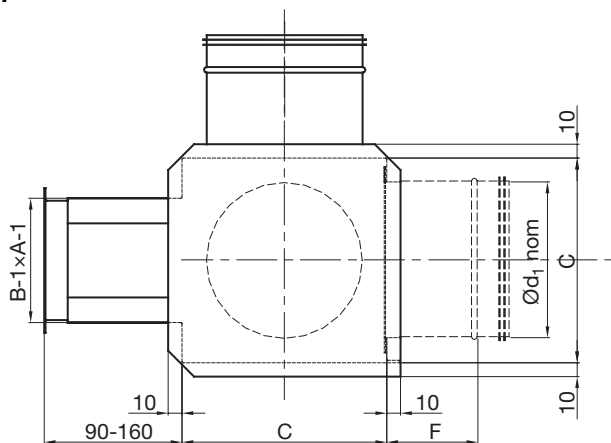

A x B mm	Ød <sub>1</sub> nom mm	C mm	F mm
200 x 100	125	165	90
300 x 100	160	200	110
300 x 150	200	240	130
400 x 100	160	200	110
400 x 150	250	290	155
400 x 200	250	290	155
500 x 100	200	240	130
500 x 150	250	290	155
500 x 200	315	355	190
600 x 150	250	290	155
600 x 200	315	355	190

## Ordering example

Product	VBA	a	bbb	ccc
Type				
Connection	1 = back 2 = side 4 = Top			
A - Measure				
B - Measure				

# Wall grille

# C20/C21

## Technical data

### Capacity

Volume flow  $q_v$  [l/s] and [m<sup>3</sup>/h], total pressure loss  $\Delta p_t$  [Pa], throw  $l_{0,2}$  [m] and sound level  $L_{WA}$  [dB(A)] can be seen in the diagrams.

Size.	Centre frequency Hz							
	63	125	250	500	1K	2K	4K	8K
Open damper	-3	-4	-3	-3	-4	-7	-17	-23
50 % open damper	-1	1	-2	-3	-4	-8	-17	-22
Closed damper	-2	0	-3	-3	-7	-9	-8	-10

### Throw $l_{0,2}$

Throw  $l_{0,2}$  [m] at an average speed of 0.2 m/s, 0° bar setting without ceiling effect (distance from diffuser to grille over 800 mm) can be seen in the diagrams. Correction for dispersal - see table below.

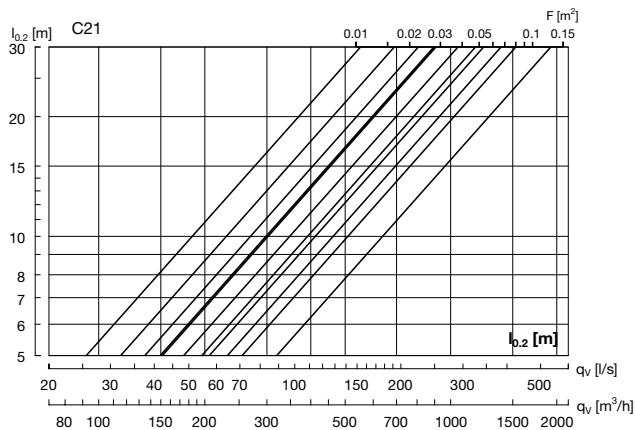

### Correction of throw

Bar setting	45°	90°
Correction factor	0,8	0,5

### Sound attenuation

The diffuser's sound attenuation function from duct to room, including end reflection - see table below

Size	Centre frequency Hz							
	63	125	250	500	1K	2K	4K	8K
200x100	25	20	12	10	6	12	12	12
300x150	16	12	8	10	10	11	11	12
300x100	23	19	11	10	8	12	10	12
400x150	14	10	8	10	11	12	10	12
400x200	15	11	9	8	8	11	12	12
400x100	21	17	10	10	8	11	11	12
500x200	13	10	9	8	8	9	10	11
500x150	15	11	9	8	8	11	10	10
500x100	20	16	9	9	8	13	11	11
600x200	13	10	9	8	8	9	11	11
600x150	14	10	8	9	8	10	10	11

### Correction sound

Correction values for conversion of diagram data for connection from the side or top – see table below.

	C20/C21 + VBA-2 side	C20/C21 + VBA-4 Top
Open damper	+2 dB	+4 dB
50% Open damper	+1 dB	+1 dB
Closed damper	0 dB	0 dB

Correction of sound level at bars (dB) - see table below.

Bar setting	45°	90°
Correction factor	+3	+10

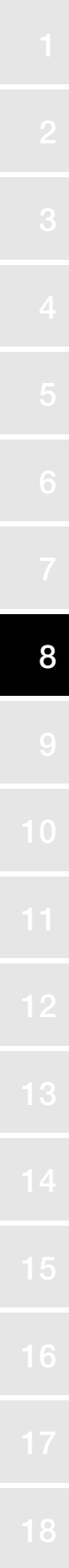

# Wall grille

# C20/C21

## Technical data

### Air jet dispersal

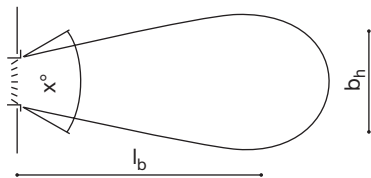
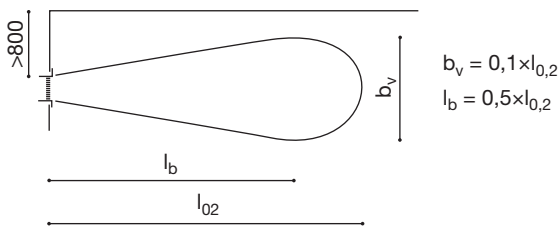
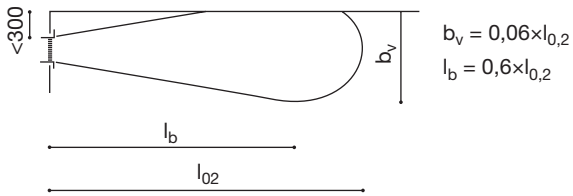

- $X = 0^\circ$  :  $b_h = 0,3 \times l_{0,2}$   $l_b = 0,5 \times l_{0,2}$
- $X = 45^\circ$  :  $b_h = 0,4 \times l_{0,2}$   $l_b = 0,5 \times l_{0,2}$
- $X = 90^\circ$  :  $b_h = 0,6 \times l_{0,2}$   $l_b = 0,5 \times l_{0,2}$

# Wall grille

# C20/C21

## Technical data

### Supply air

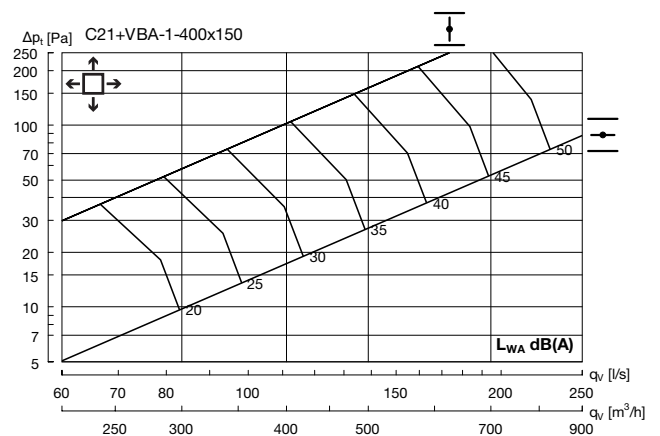
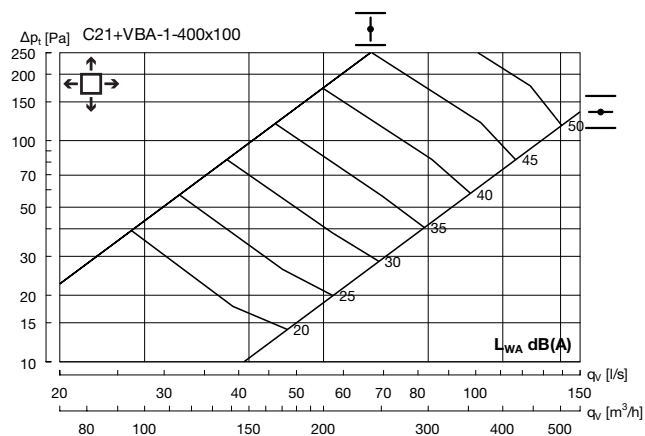
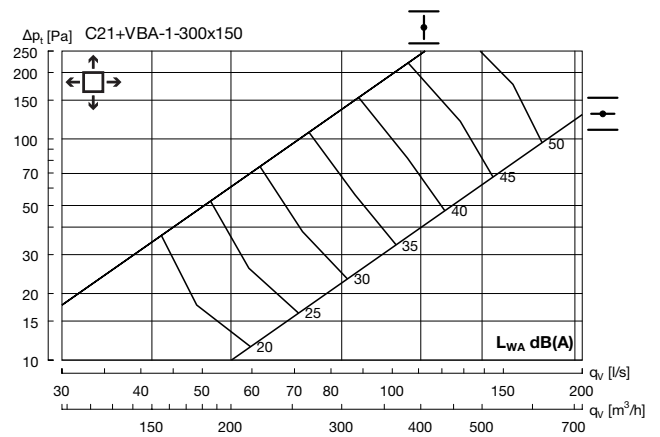
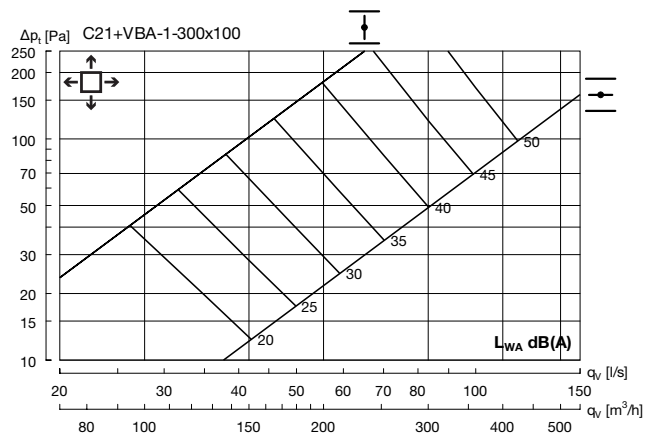
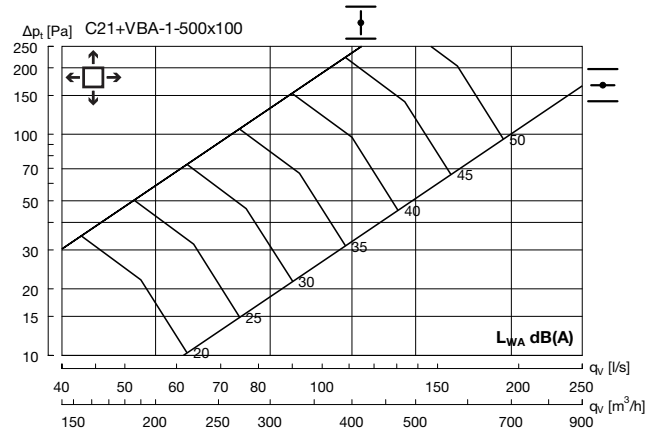
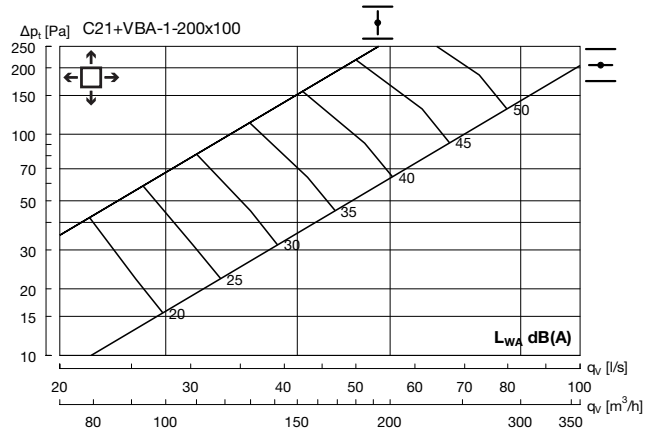

- 1
- 2
- 3
- 4
- 5
- 6
- 7
- 8
- 9
- 10
- 11
- 12
- 13
- 14
- 15
- 16
- 17
- 18

# Wall grille

# C20/C21

## Technical data

### Supply air

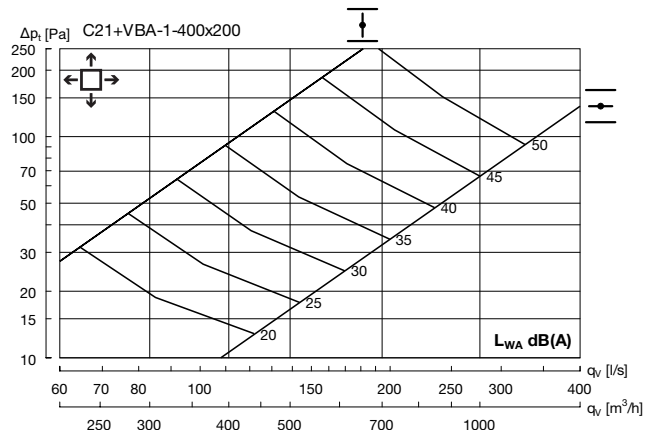
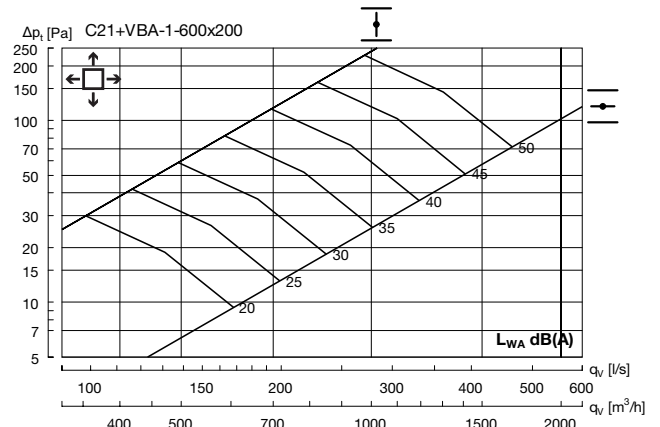
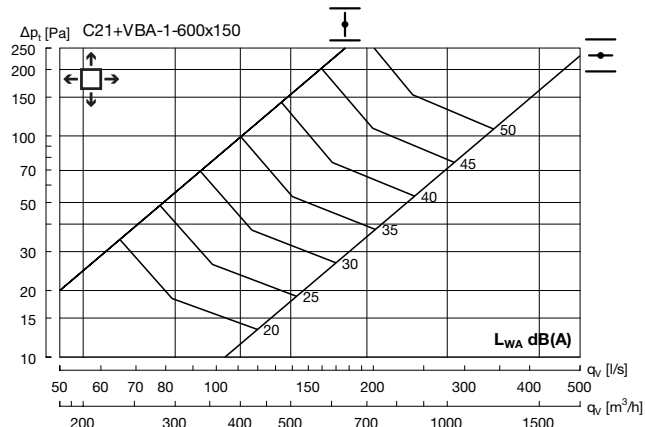
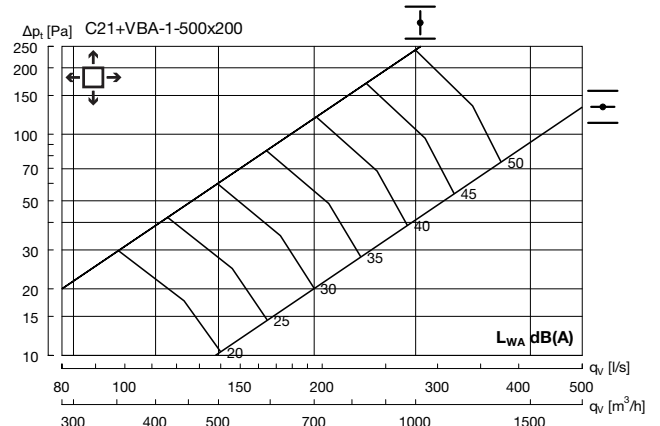
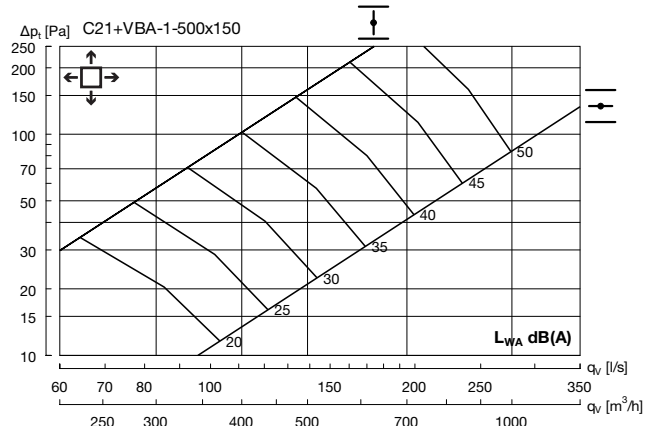

# Wall grille

# F20



## Description

F20 is a rectangular aluminium grille with fixed slanting horizontal bars. F20 is used for air exhaust and is supplied as standard with springs for installation in plenum boxes type VBA and WB. In the product photo the grille is shown with a VBA box.

## Maintenance

The grille should be removed to gain access to the plenum box or duct. The external parts should be wiped with a damp cloth.

## Dimensions

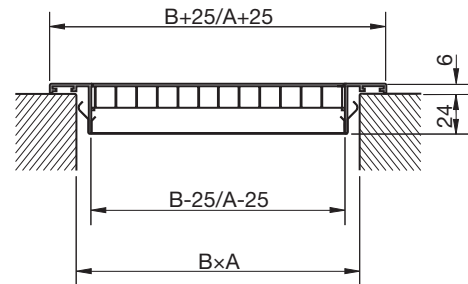

A x B mm	Free area F(m <sup>2</sup> )	Weight kg
200 x 100	0,0111	0,2
300 x 100	0,0144	0,3
400 x 100	0,0240	0,3
500 x 100	0,0301	0,4
300 x 150	0,0292	0,3
400 x 150	0,0398	0,4
500 x 150	0,0504	0,5
600 x 150	0,0610	0,6
400 x 200	0,0557	0,5
500 x 200	0,0706	0,6
600 x 200	0,0854	0,7

## Ordering example

<b>Product</b>	<b>F20</b>	<b>aaa</b>	<b>bbb</b>
Type			
A - Measure			
B - Measure			

## Materials and finish

Grille: Aluminium  
 Standard finish: Natural anodized  
 On request: RAL 9010, gloss 30

The grille is available in other colours. Please contact Lindab's sales department for further information.

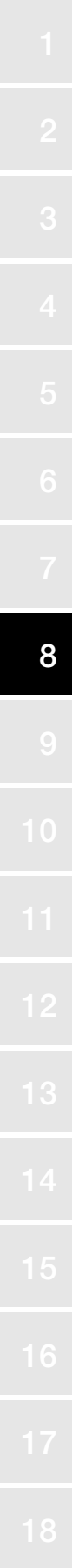

# Wall grille

# F20

## Dimensions

1:

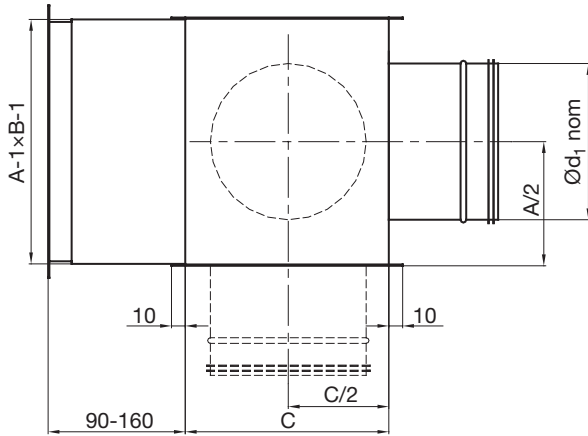

2:

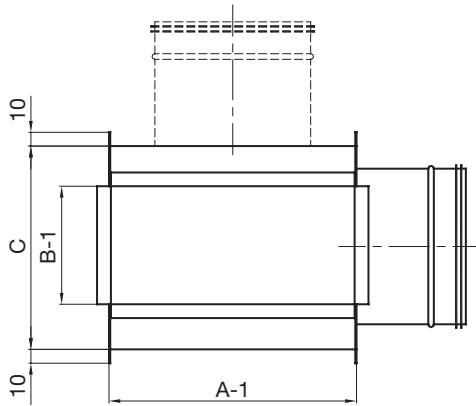

4:

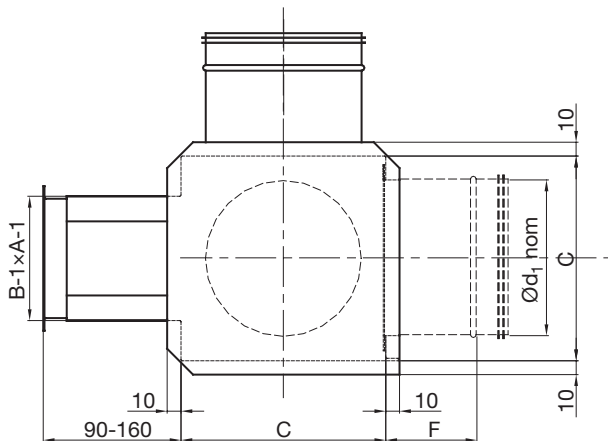

A x B mm	Ød <sub>1</sub> nom mm	C mm	F mm
200 x 100	125	165	90
300 x 100	160	200	110
300 x 150	200	240	130
400 x 100	160	200	110
400 x 150	250	290	155
400 x 200	250	290	155
500 x 100	200	240	130
500 x 150	250	290	155
500 x 200	315	355	190
600 x 150	250	290	155
600 x 200	315	355	190

## Ordering example

<b>Product</b>	<b>VBA</b>	<b>a</b>	<b>bbb</b>	<b>ccc</b>
Type				
Connection	1 = Rear 2 = Side 4 = Top			
A - Measure				
B - Measure				

# Wall grille

# F20

## Technical data

### Capacity

Volume flow  $q_v$  [l/s] and [m<sup>3</sup>/h], total pressure drop  $\Delta p_t$  [Pa], and sound level  $L_{WA}$  [dB(A)] can be seen in the diagrams.

Size.	Centre frequency Hz							
	63	125	250	500	1K	2K	4K	8K
Open damper	-7	-2	-2	-4	-3	-8	-17	-24
50 % open damper	-5	2	0	-3	-4	-10	-15	-21
Closed damper	-8	-2	-2	-3	-4	-9	-11	-13

### Correction sound

Correction values for conversion of diagram data for connection from the side or top – see table below.

	F20 + VBA-2 side	F20 + VBA-4 Top
Open damper	+2 dB	+4 dB
50% Open damper	+1 dB	+1 dB
Closed damper	0 dB	0 dB

### Sound attenuation

The diffuser's sound attenuation function from duct to room, including end reflection - see table below (incl. VBA).

Size	Centre frequency Hz							
	63	125	250	500	1K	2K	4K	8K
200x100	25	20	12	10	6	12	12	12
300x150	16	12	8	10	10	11	11	12
300x100	23	19	11	10	8	12	10	12
400x150	14	10	8	10	11	12	10	12
400x200	15	11	9	8	8	11	12	12
400x100	21	17	10	10	8	11	11	12
500x200	13	10	9	8	8	9	10	11
500x150	15	11	9	8	8	11	10	10
500x100	20	16	9	9	8	13	11	11
600x200	13	10	9	8	8	9	11	11
600x150	14	10	8	9	8	10	10	11

1

2

3

4

5

6

7

8

9

10

11

12

13

14

15

16

17

18

# Wall grille

# F20

## Technical data

### Exhaust air

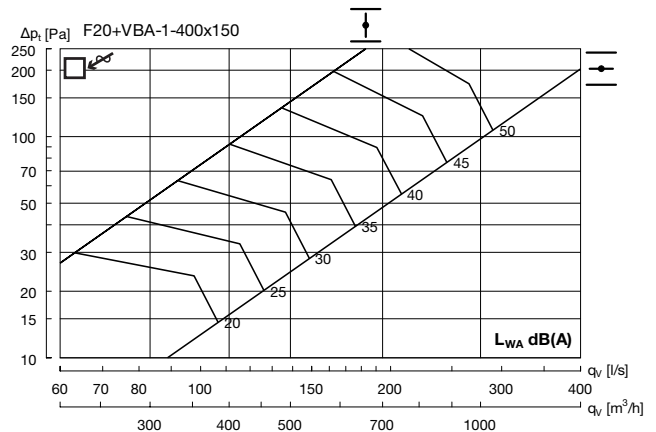
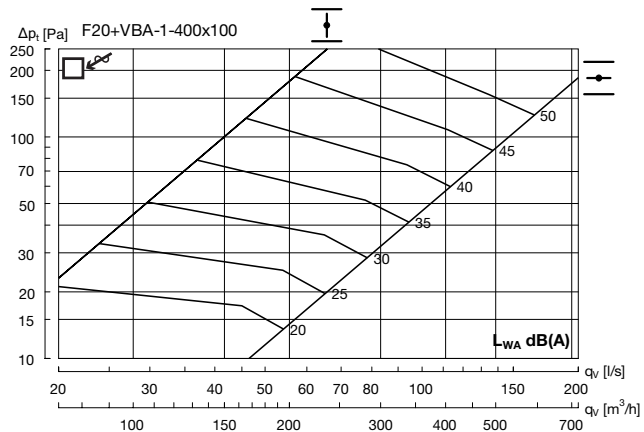
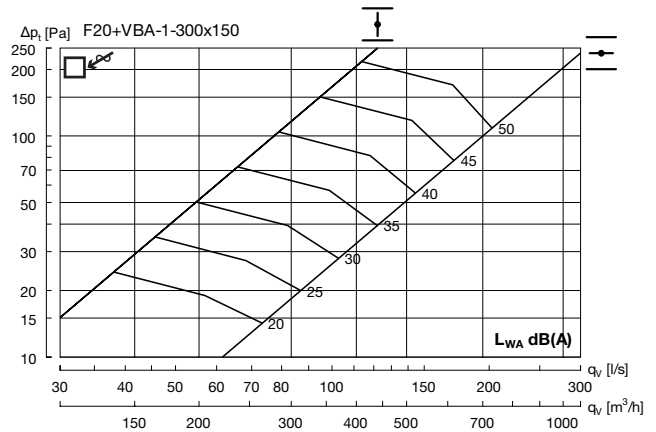
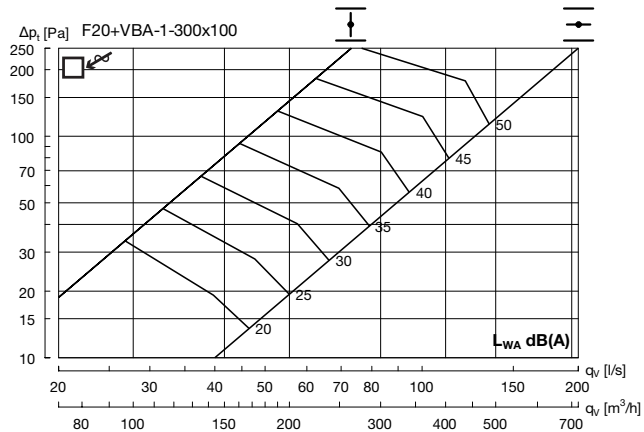
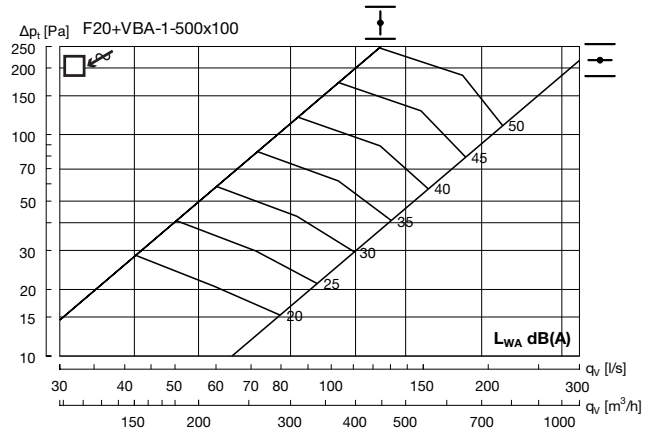
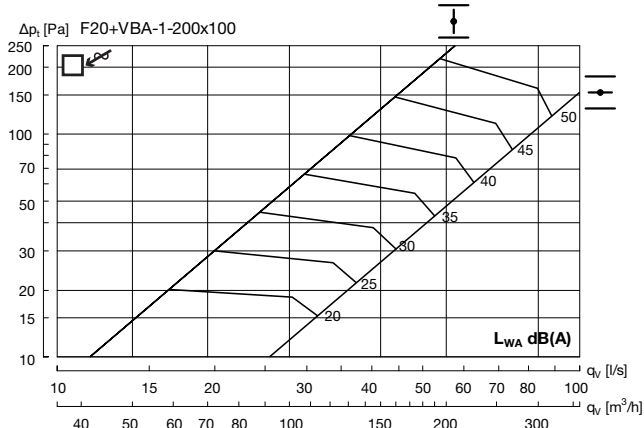

# Wall grille

# F20

## Technical data

### Exhaust air

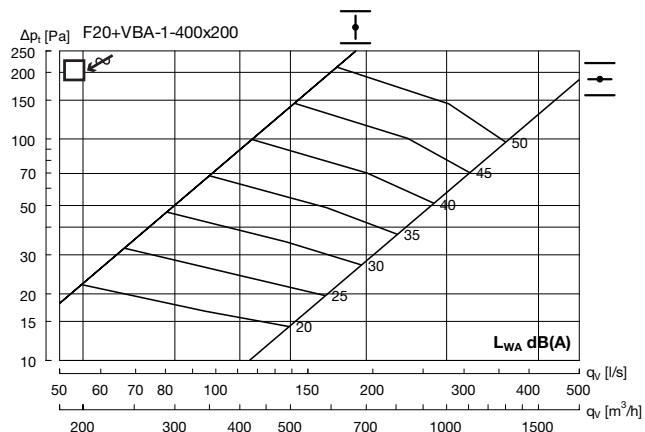
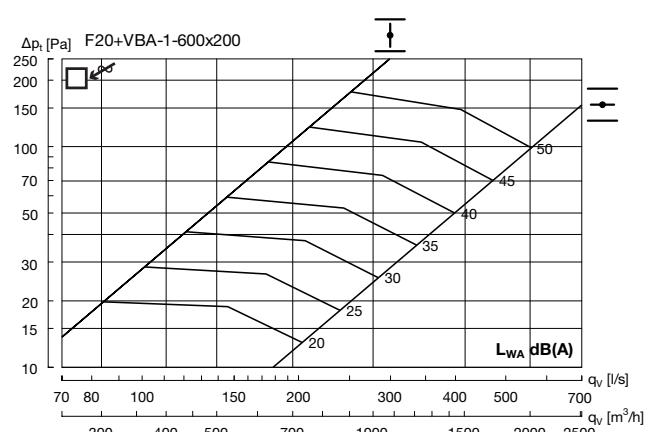
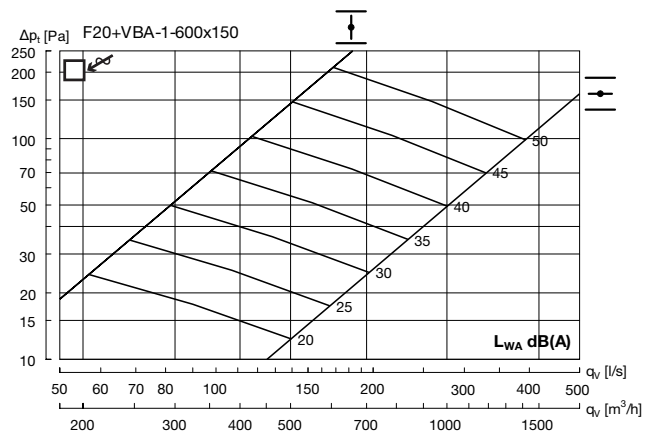
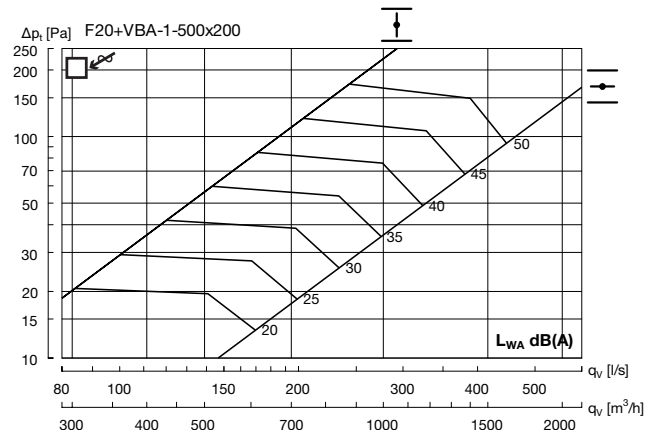
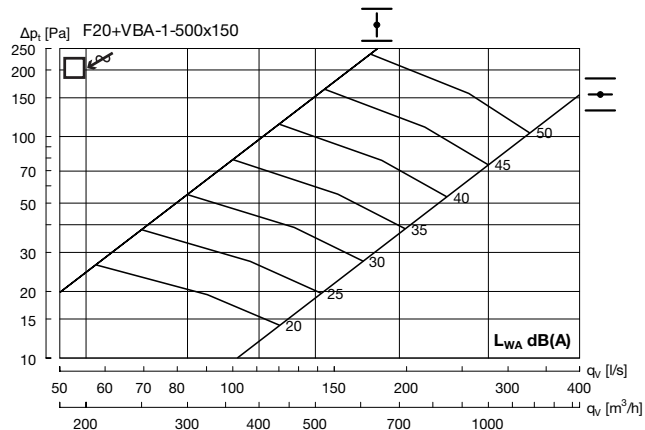

- 1
- 2
- 3
- 4
- 5
- 6
- 7
- 8
- 9
- 10
- 11
- 12
- 13
- 14
- 15
- 16
- 17
- 18

# Wall grille

# G20



## Description

G20 is a rectangular aluminium grille with fixed slanting horizontal bars. G20 can be used for exhaust. G20 is supplied as standard with springs for installation in plenum boxes, type VBA. In the product photo the grille is shown with a VBA box

## Maintenance

The grille should be removed to gain access to the plenum box or duct. The external parts should be wiped with a damp cloth.

## Dimensions

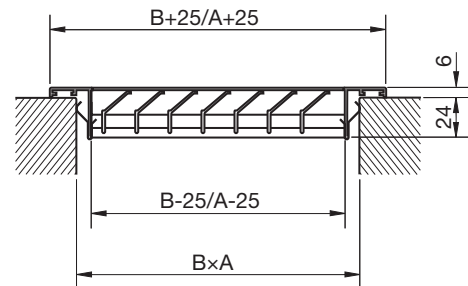

A x B mm	Free area F(m <sup>2</sup> )	Weight kg
200 x 100	0,0066	0,3
300 x 100	0,0103	0,3
400 x 100	0,0141	0,4
500 x 100	0,0178	0,6
300 x 150	0,0172	0,5
400 x 150	0,0234	0,6
500 x 150	0,0297	0,9
400 x 200	0,0328	0,8
500 x 200	0,0416	1,2
600 x 150	0,0359	1,0
600 x 200	0,0503	1,4

## Ordering example

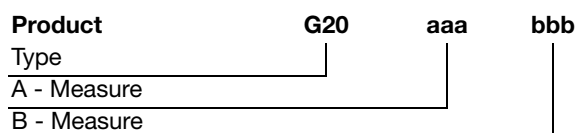

## Materials and finish

Grille: Aluminium  
 Standard finish: Natural anodized  
 On request: RAL 9010, gloss 30

The grille is available in other colours. Please contact Lindab's sales department for further information.

# Wall grille

# G20

## Dimensions

1:

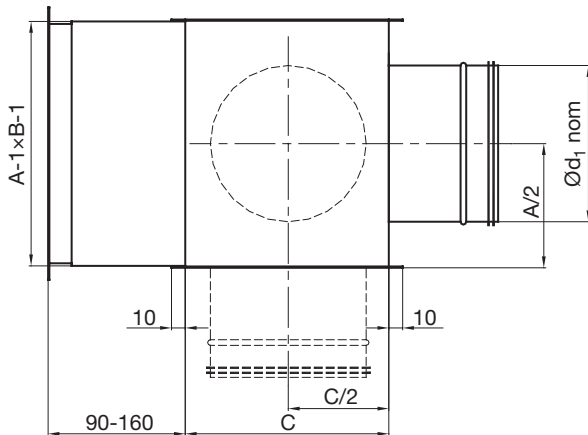

2:

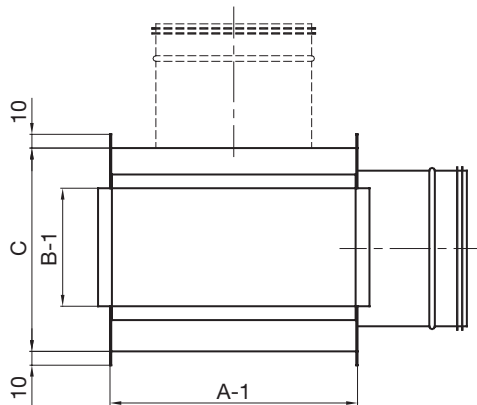

4:

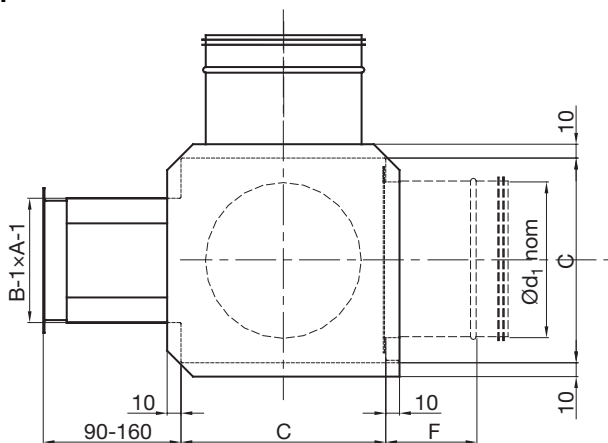

A x B mm	Ød <sub>1</sub> nom mm	C mm	F mm
200x100	125	165	90
300x100	160	200	110
300x150	200	240	130
400x100	160	200	110
400x200	250	290	155
400x150	250	290	155
500x100	200	240	130
500x150	250	290	155
500x200	315	355	190
600x150	250	290	155
600x200	315	355	190

## Ordering example

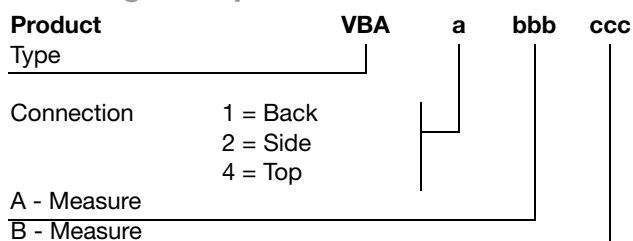

- 1
- 2
- 3
- 4
- 5
- 6
- 7
- 8
- 9
- 10
- 11
- 12
- 13
- 14
- 15
- 16
- 17
- 18

# Wall grille

G20

## Technical data

### Capacity

Volume flow  $q_v$  [l/s] and [m<sup>3</sup>/h], total pressure drop  $\Delta p_t$  [Pa], throw  $l_{0,2}$  and sound level  $L_{WA}$  [dB(A)] can be seen in the diagrams.

	Centre frequency Hz							
	63	125	250	500	1K	2K	4K	8K
Open damper	-1	-2	5	-1	-7	-16	-25	-31
50 % open damper	-3	2	2	0	-7	-12	-19	-30
Closed damper	-7	0	-2	-3	-7	-7	-10	-17

### Correction sound

Correction values for conversion of diagram data for connection from the side or top – see table below.

	G20 + VBA-2 side	G20 + VBA-4 Top
Open damper	+2 dB	+4 dB
50% Open damper	+1 dB	+1 dB
Closed damper	0 dB	0 dB

### Sound attenuation

The diffuser's sound attenuation function from duct to room, including end reflection - see table below (incl. VBA).

Size	Centre frequency Hz							
	63	125	250	500	1K	2K	4K	8K
200x100	25	20	12	10	6	12	12	12
300x150	16	12	8	10	10	11	11	12
300x100	23	19	11	10	8	12	10	12
400x150	14	10	8	10	11	12	10	12
400x200	15	11	9	8	8	11	12	12
400x100	21	17	10	10	8	11	11	12
500x200	13	10	9	8	8	9	10	11
500x150	15	11	9	8	8	11	10	10
500x100	20	16	9	9	8	13	11	11
600x200	13	10	9	8	8	9	11	11
600x150	14	10	8	9	8	10	10	11

# Wall grille

# G20

## Technical data

### Exhaust air

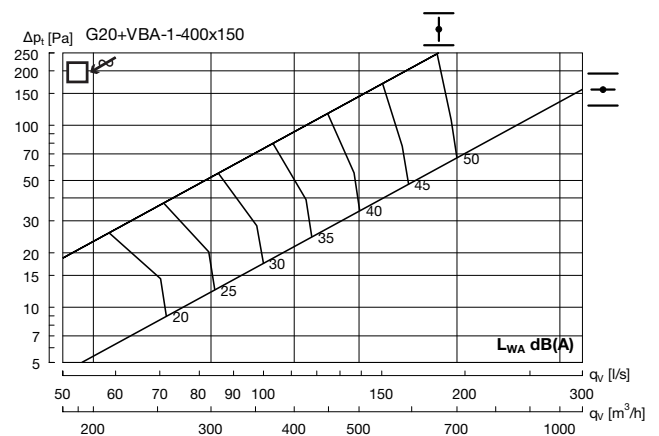
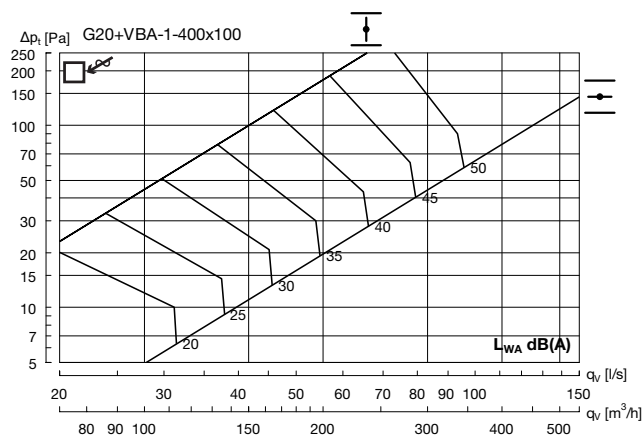
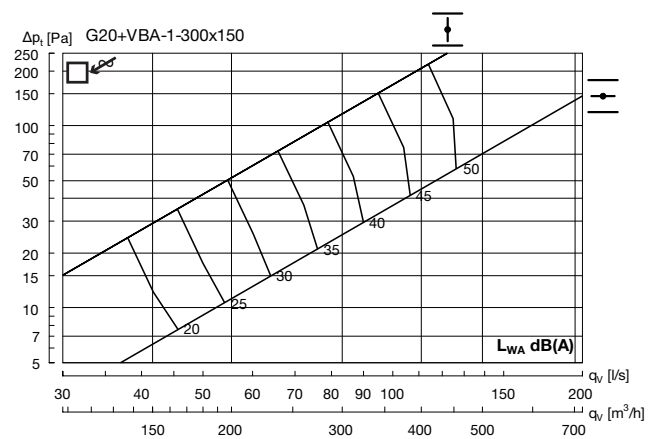
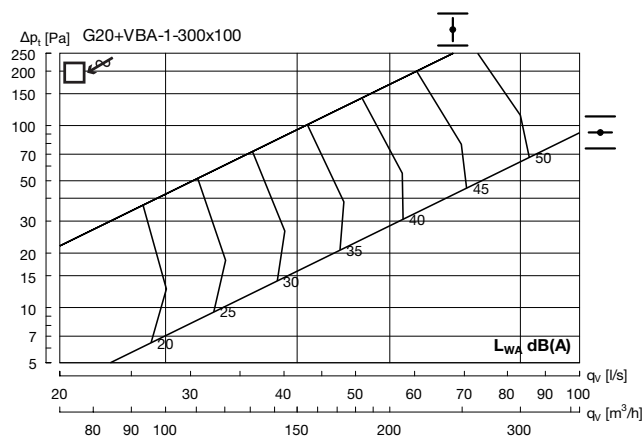
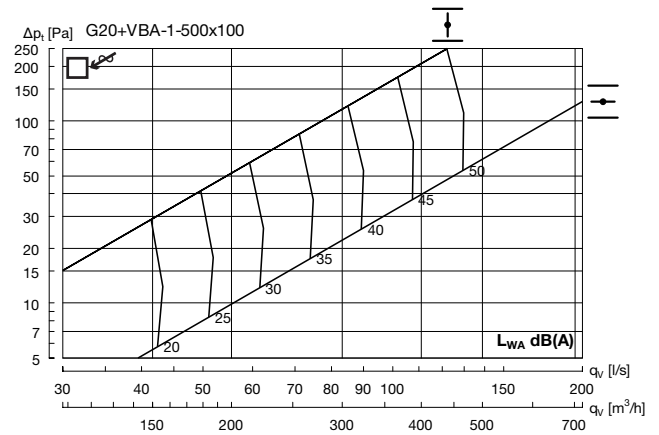
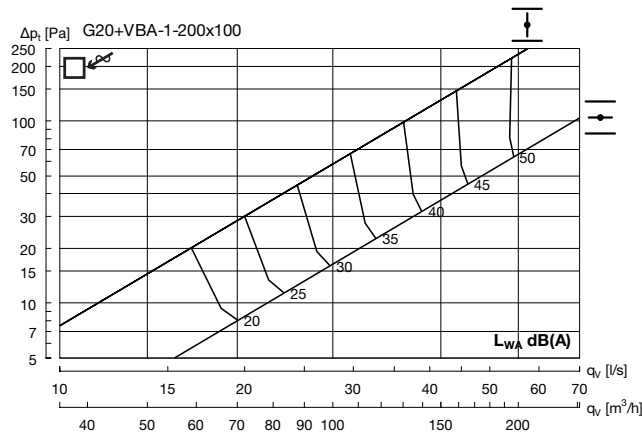

- 1
- 2
- 3
- 4
- 5
- 6
- 7
- 8
- 9
- 10
- 11
- 12
- 13
- 14
- 15
- 16
- 17
- 18

# Wall grille

# G20

## Technical data

### Exhaust air

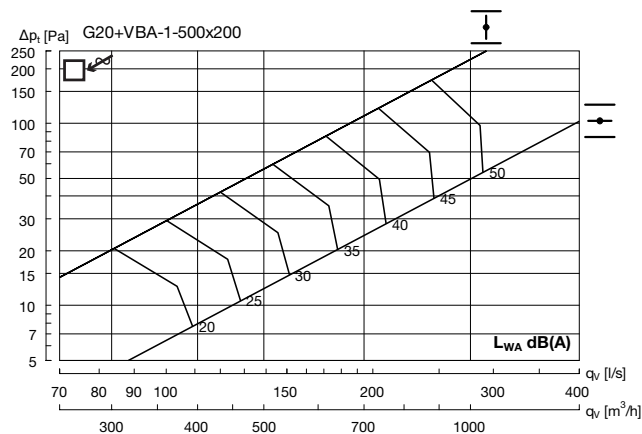
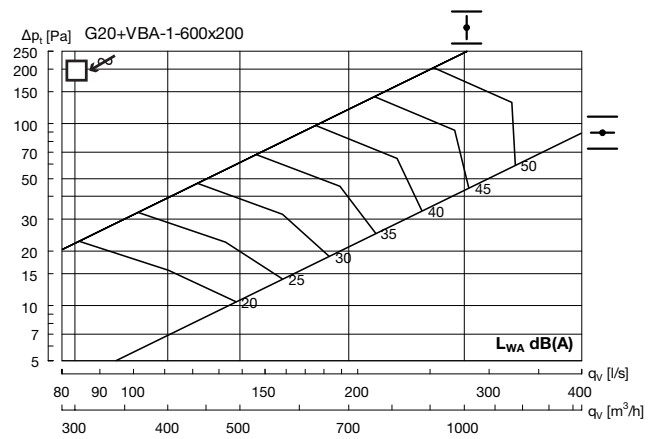
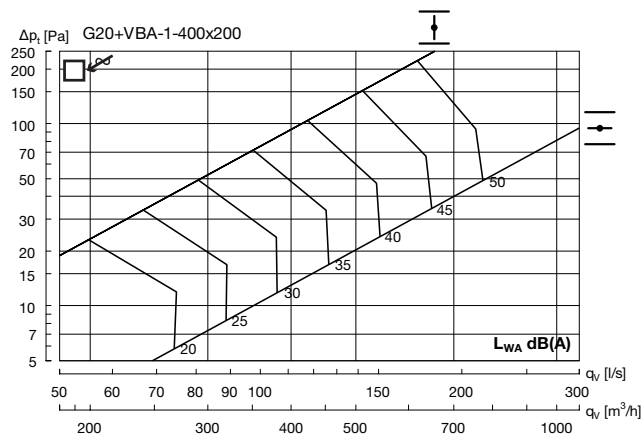
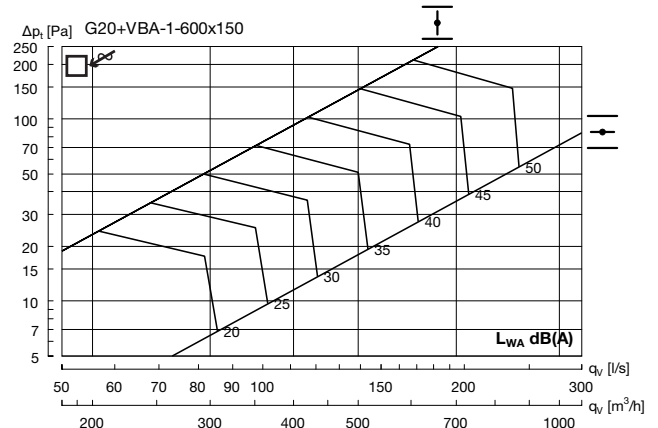
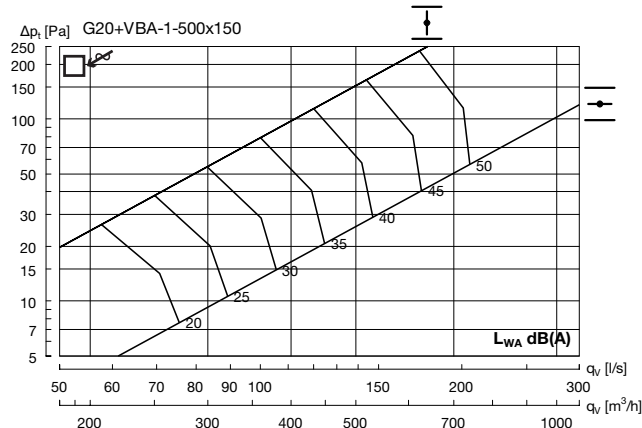

1

2

3

4

5

6

7

8

9

10

11

12

13

14

15

16

17

18