

Lindab Integra











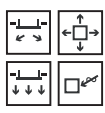

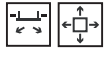

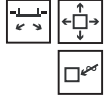

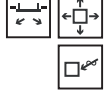

- 1
- 2
- 3
- 4
- 5
- 6
- 7
- 8
- 9
- 10
- 11
- 12
- 13
- 14
- 15
- 16
- 17
- 18

PC7, Integrated in Luxalon Clip-In ceiling with adapted module plate type LM.

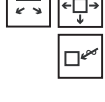
Lindab Integra a series of flush diffusers

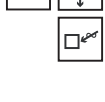
Mixed ventilation diffusers

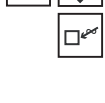
		Product	Functions	Page
1				
2		PC6		125
3				
4		PC7		135
5		RC14		141
6				
7		RC15		151
8				
9		NC19		161
10		RCG		169
11		LCC		176
12				
13		LCP		177
14		LKP		177
15				
16				
17				
18				

Lindab Integra

a series of flush diffusers

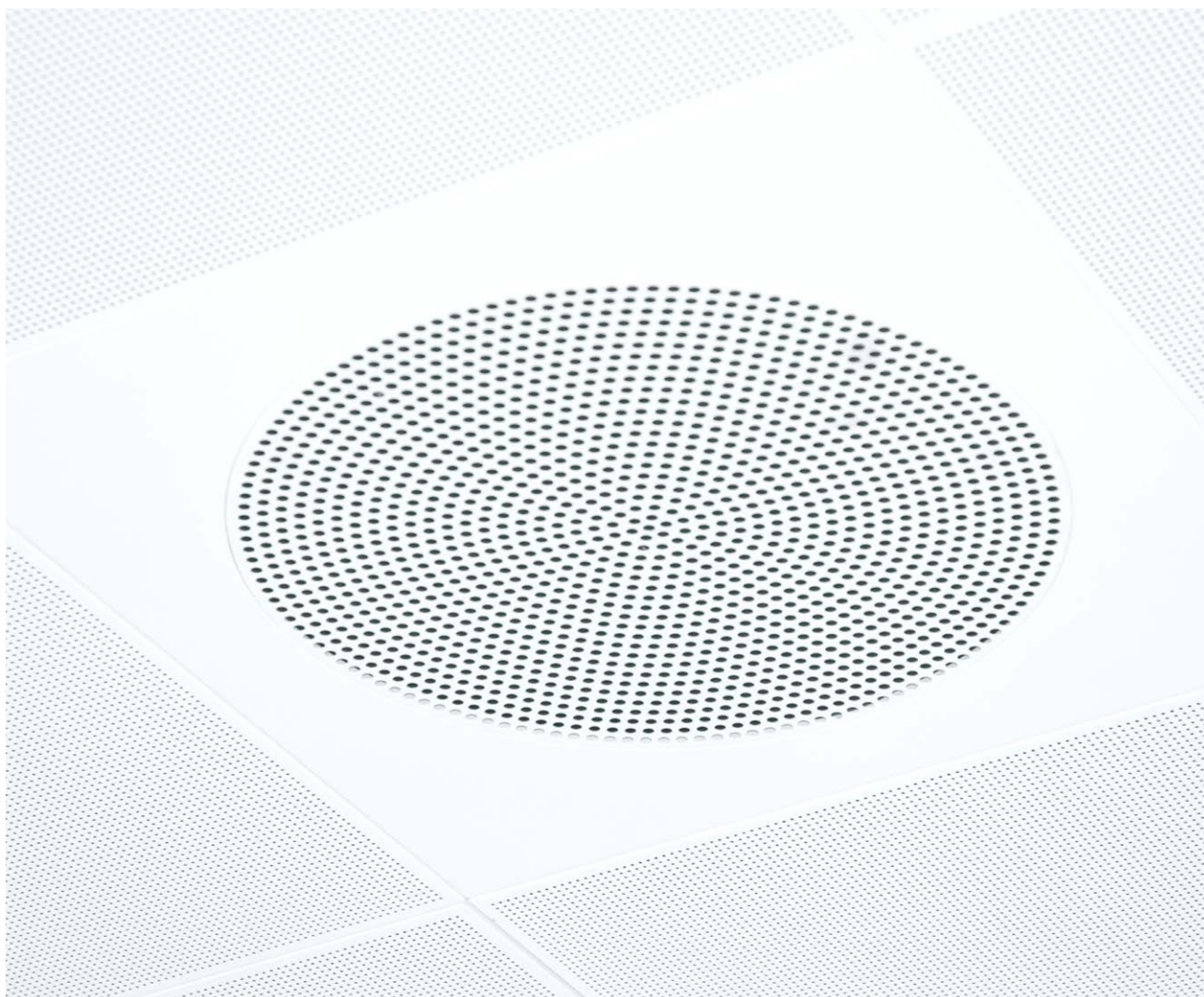

PC7, Integrated in Luxalon Clip-In ceiling with adapted module plate, type LM.

Lindab Integra

Integra is a series of flush mounted ceiling diffusers for mixed ventilation. The diffusers are primarily offered in circular, but are also available in square forms with a large selection of face plates in different designs, which satisfy requirements as well as function. The circular diffusers are normally cut directly into the ceiling when mounted, but can by using module plates be adapted for the most common 600x600 ceiling systems. The square diffusers in this series are adapted to the system-ceiling. The diffusers can be mounted in a plenum box type MBB with great advantage, in order to obtain a stable air flow to the diffuser and the possibility for individual adjustments.

Functionality

Integra has a unique magnetic mounting system of the face plates on all circular diffusers with exception of RCG. This ensures an incredibly easy access to all the internal components, which can be detached without the use of tools, and gives free access to the air duct system for cleaning.



PC6, ceiling diffusers

Lindab Integra a series of flush diffusers

Design

See [Comfort and design](#)



Ventilation principle
Supply/exhaust

Size

Accessories

See [product pages](#)

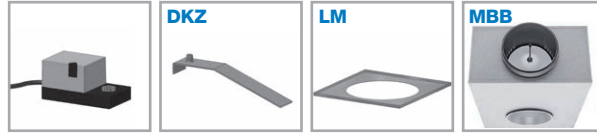

Product

	Perforated	Perforated swirl	Swirl	Swirl	Nozzle	Swirl	Plain	Plain
PC6	 125 160 200 250 315	 160 200 250 315	 160 200 250 315	 160 200 250 315	 125 160 200 250 315	 125 160 200 250 315 400	 125 160 200 250 315	 125 160 200 250 315
	El. - motor	Bracket	Module pl.	MBB box	El. - motor	Bracket	Module pl.	MBB box

Lindab Integra a series of flush diffusers

Ceiling tile adaption

Details, see [Chapter Ceiling tile adaption](#)

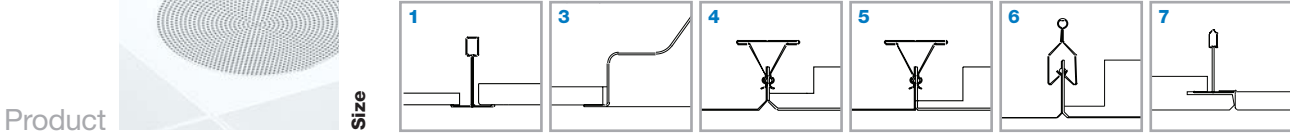

Product

Size

Ceiling types

Danotile T24/T15
Ecophon T24
Rockfon A24.

Plasterboard
ceiling

Dampa Clip-In
bevelled edge

Dampa Clip-In
square edge

Luxalon SQ
Clip-In

Danotile Contur
Ecophon D
Rockfon D-XL

Perforated

mm

F: 595 mm

ØA mm

F: 600 mm

F: 600 mm

F: 600 mm

F: 599 mm

PC6		125	●	Standard	●	●	●	●
		160	●		●	●	●	●
		200	●		●	●	●	●
		250	●		●	●	●	●
		315	●		●	●	●	●

Perforated swirl

mm

F: 595 mm

ØA mm

F: 600 mm

F: 600 mm

F: 600 mm

F: 599 mm

PC7		160	●	Standard	●	●	●	●
		200	●		●	●	●	●
		250	●		●	●	●	●
		315	●		●	●	●	●
			●		●	●	●	●

Swirl

mm

F: 595 mm

ØA mm

F: 600 mm

F: 600 mm

F: 600 mm

F: 599 mm

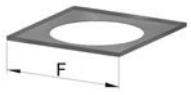
RC14		160	●	Standard	●	●	●	●
		200	●		●	●	●	●
		250	●		●	●	●	●
		315	●		●	●	●	●
			●		●	●	●	●

Swirl

mm

F: 595 mm

ØA mm

F: 600 mm

F: 600 mm

F: 600 mm

F: 599 mm

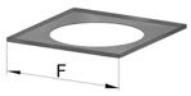
RC15		160	●	Standard	●	●	●	●
		200	●		●	●	●	●
		250	●		●	●	●	●
		315	●		●	●	●	●
			●		●	●	●	●

Nozzles

mm

F: 595 mm

ØA mm

F: 600 mm

F: 600 mm

F: 600 mm

F: 599 mm

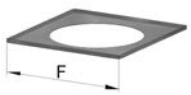
NC19		125	●	Standard	●	●	●	●
		160	●		●	●	●	●
		200	●		●	●	●	●
		250	●		●	●	●	●
		315	●		●	●	●	●

Swirl

mm

F: 595 mm

ØD mm

F: 600 mm

F: 600 mm

F: 600 mm

F: 599 mm

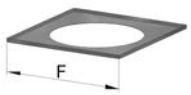
RCG		125	●	Standard	●	●	●	●
		160	●		●	●	●	●
		200	●		●	●	●	●
		250	●		●	●	●	●
		315	●		●	●	●	●
		400	●		●	●	●	●

Plain

mm

F: 595 mm

595 x 595 mm

F: 600 mm

F: 600 mm

F: 600 mm

F: 599 mm

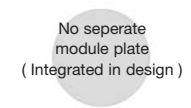
LCP		125	Standard*	●	●	●	●	●
		160	Standard*		●	●	●	●
		200	Standard*		●	●	●	●
		250	Standard*		●	●	●	●
		315	Standard*		●	●	●	●

Plain

mm

F: 595 mm

595 x 595 mm

F: 600 mm

F: 600 mm

F: 600 mm



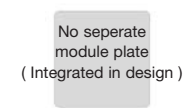

F: 599 mm

LKP		125	Standard*	●	●	●	●	●
		160	Standard*		●	●	●	●
		200	Standard*		●	●	●	●
		250	Standard*		●	●	●	●
		315	Standard*		●	●	●	●

* In other ceiling systems the grille box is adapted to the ceiling

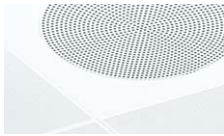
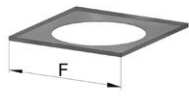
Lindab Integra

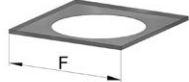
a series of flush diffusers

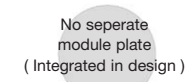
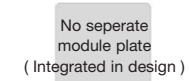
Product		Size	Ceiling types				
			8	9	10	11	14
			Ecophon Focus DG	Rockfon E10 24 Ecophon - E / T24	Rockfon E10 15 Ecophon - E / T15	Danotile Markant	Ecophon Focus edge DS
			F: 592 mm	F: 575 mm	F: 584 mm	F: 575 mm	F: 599 mm
PC6		125 160 200 250 315					
	Perforated	mm	F: 592 mm	F: 575 mm	F: 584 mm	F: 575 mm	F: 599 mm
PC7		160 200 250 315					
	Perforated swirl	mm	F: 592 mm	F: 575 mm	F: 584 mm	F: 575 mm	F: 599 mm
RC14		160 200 250 315					
	Swirl	mm	F: 592 mm	F: 575 mm	F: 584 mm	F: 575 mm	F: 599 mm
RC15		160 200 250 315					
	Swirl	mm	F: 592 mm	F: 575 mm	F: 584 mm	F: 575 mm	F: 599 mm
NC19		125 160 200 250 315					
	Nozzles	mm	F: 592 mm	F: 575 mm	F: 584 mm	F: 575 mm	F: 599 mm
RCG		125 160 200 250 315 400					
	Swirl	mm	F: 592 mm	F: 575 mm	F: 584 mm	F: 575 mm	F: 599 mm
LCP	 <p>No separate module plate (Integrated in design)</p>	125 160 200 250 315					
	Plain	mm	F: 592 mm	F: 575 mm	F: 584 mm	F: 575 mm	F: 599 mm
LKP	 <p>No separate module plate (Integrated in design)</p>	125 160 200 250 315					
	Plain	mm	F: 592 mm	F: 575 mm	F: 584 mm	F: 575 mm	F: 599 mm

- 1
- 2
- 3
- 4
- 5
- 6
- 7
- 8
- 9
- 10
- 11
- 12
- 13
- 14
- 15
- 16
- 17
- 18

Perforated diffuser

PC6



Description

PC6 is a circular perforated diffuser that can be used for both supply air and exhaust. The diffuser is suitable for the horizontal supply of cooled air. The diffuser can also be used for low impulse and is therefore useful for the supply of replacement air in environments with high rates of air exchange. Installing this diffuser in a plenum box type MBB can help to achieve a stable flow of air to the diffuser as well as realise the potential for individual adjustment.

- Suitable for both supply and exhaust air
- Discrete design
- Can be used for low impulse supply air

Maintenance

The face plate can be removed to enable cleaning of internal parts or to gain access to the duct or box. The visible parts of the diffuser can be wiped with a damp cloth.

Order code

Product	PC6	a	bbb
Type	PC6		
Functional use			
S = Supply air			
E = Exhaust			
L = Low-impulse			
Connection dim.			
Ød 125-315			

Example: PC6-S-200

Dimensions

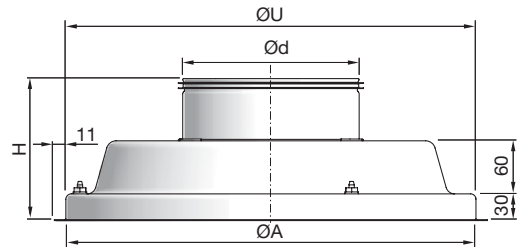

PC6 Ød mm	ØA mm	H mm	ØU* mm	Weight kg
125	360	140	370	3.90
160	460	140	470	5.30
200	460	140	470	5.40
250	540	140	550	7.40
315	540	140	550	8.10

* ØU = ceiling grid opening

Ød 315, No mounting holes for MBB !

PC6-S



Materials and finish

Material: Galvanised steel
 Standard finish: Powder-coated
 Standard colour: RAL 9010 Gloss 30

The diffuser is available in other colours. Please contact Lindab's sales department for further information.

Perforated diffuser

PC6

Accessories

Mounting brackets

DCZ

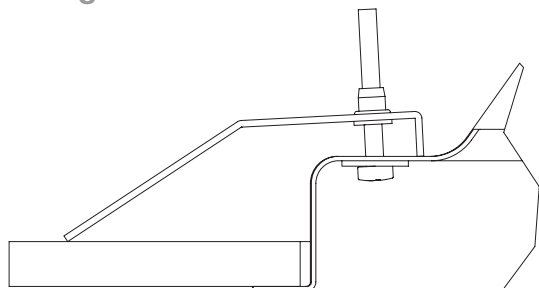

Plenum box

MBB



Extension piece

MBZ

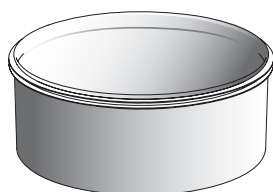

PC6 + MBB

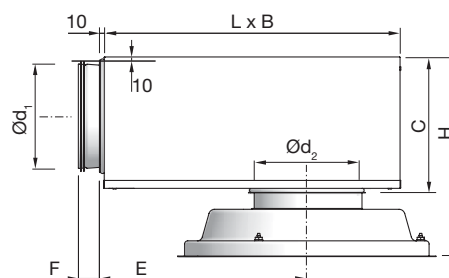

Order code - accessoires

Product	aaa	bbb
Type		
Size		

Example: MBZ-200

PC6 + MBB		B	C	E	F	H*	L
duct	PC6	mm	mm	mm	mm	mm	mm
Ød ₁ mm	Ød ₂ mm						
100	125	260	159	216	50	250 - 290	310
100	160	260	159	216	50	250 - 290	310
125	125	310	184	262	50	275 - 315	376
125	160	310	184	262	50	275 - 315	376
125	200	310	184	262	50	275 - 315	376
160	160	380	220	323	50	309 - 349	459
160	200	380	220	323	50	309 - 349	459
160	250	380	220	323	50	309 - 349	459
200	200	460	259	396	70	350 - 390	565
200	250	460	259	396	70	350 - 390	565
200	315	460	259	396	70	350 - 390	565
250	250	540	309	486	70	400 - 440	698
250	315	540	309	486	70	400 - 440	698
315	315	540	373	646	70	465 - 505	858

* Using accessory MBZ the H dimension will increase:

Ød₂ = 125 - 200 mm => H +40 mm

Ød₂ = 250 - 315 mm => H +60 mm

Module plate

LM



Order code - module plate

Product	LM	a	PC6	ccc
Type				
Ceiling system				
Diffuser				
Size				

Example: LM-1-PC6-200

Ceiling system - see introductory summary

Order code

Product	MBB	aaa	bbb	c
Type				
MBB				
Duct connection Ød ₁				
Ø100-315				
Diffuser dimension Ød ₂				
Ø125-315				
Functional use				
S = Supply air				
E = Exhaust				

Example: PC6-S-200-MBB-160-200-S

Perforated diffuser

PC6

Technical data

Capacity

Air flow q_v [l/s] and [m³/h], total pressure Δp_t [Pa], throw $l_{0,2}$ [m] and sound power level L_{WA} [dB(A)] can be seen in the diagrams.

Frequency-related sound effect level

The sound effect level in the frequency band is defined as $L_{WA}+K_{ok}$. K_{ok} values are specified in charts beneath the diagrams on the following pages.

Quick selection, supply air

PC6 + MBB		$\Delta p_t \geq 50$ Pa 30 dB(A)		$\Delta p_t \geq 50$ Pa 35 dB(A)	
duct $\varnothing d_1$	PC6 $\varnothing d_2$	l/s	m ³ /h	l/s	m ³ /h
100	125	32	115	38	137
100	160	39	140	46	166
125	125	39	140	46	166
125	160	48	173	62	223
125	200	56	202	66	238
160	160	53	191	62	223
160	200	66	238	78	281
160	250	74	266	95	342
200	200	71	256	85	306
200	250	92	331	112	403
200	315	113	407	138	497
250	250	110	396	130	468
250	315	122	439	152	547
315	315	156	562	188	677

Low-impulse

Correction sound power level (L_{WA}) and pressure loss (Δp_t)

On the following pages you can find diagrams for all sizes PC6+MBB supply air. When low-impulse values are wanted use the correction factors in the table below.

PC6-L + MBB		Low-impulse Correction factor	
duct $\varnothing d_1$	PC6-L $\varnothing d_2$	L_{WA}	Δp_t
100	125	-1	x 1
100	160	1	x 1
125	125	-4	x 1
125	160	-1	x 1
125	200	-2	x 1
160	160	-5	x 0,9
160	200	-3	x 1
160	250	-2	x 1
200	200	0	x 1
200	250	0	x 1
200	315	-1	x 1
250	250	-5	x 0,9
250	315	-2	x 1
315	315	0	x 1

Throw $l_{0,2}$

Throw $l_{0,2}$ [m] is specified at a terminal velocity of 0.2 m/s.

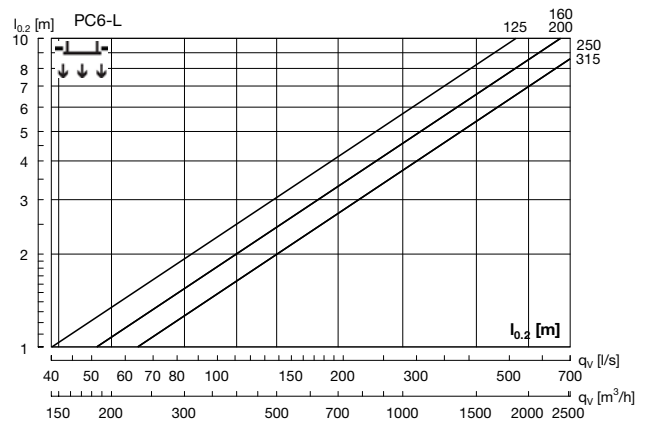
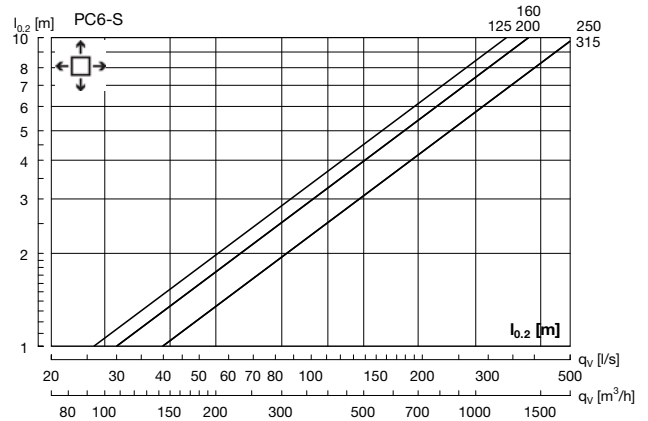

Sound attenuation

Sound attenuation of the diffusers ΔL from duct to room, including end reflection, see table below.

PC6 + MBB		Centre frequency Hz							
duct $\varnothing d_1$	PC6 $\varnothing d_2$	63	125	250	500	1K	2K	4K	8K
100	125	19	16	7	15	19	18	19	21
100	160	17	15	4	14	17	17	17	18
125	125	17	15	9	19	17	19	18	20
125	160	15	14	8	18	15	16	17	19
125	200	13	11	4	14	13	15	16	17
160	160	15	15	10	21	17	18	19	20
160	200	18	15	8	21	17	17	18	19
160	250	16	14	5	17	13	15	17	18
200	200	13	11	8	16	18	16	19	17
200	250	13	9	5	14	16	15	18	16
200	315	13	8	3	10	16	14	16	16
250	250	14	8	7	15	17	17	18	17
250	315	13	7	6	14	16	15	16	17
315	315	8	9	8	14	17	16	17	21

Balancing

Balancing data is contained in a separate brochure.

Perforated diffuser

PC6

Technical data

PC6 without box - Supply air

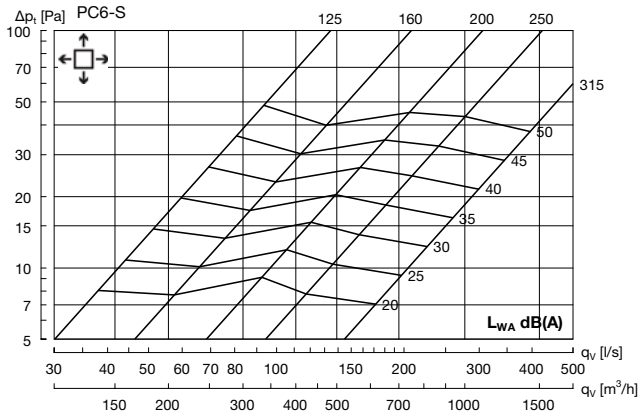

PC6 125 + MBB - Supply air

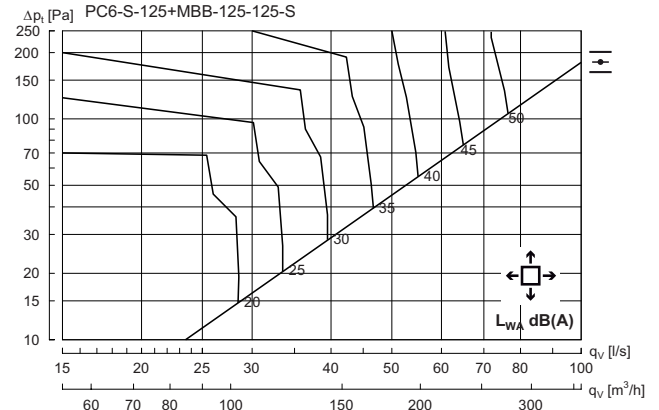

Hz	63	125	250	500	1K	2K	4K	8K
K_{ok}	7	2	-4	0	-4	-14	-23	-32

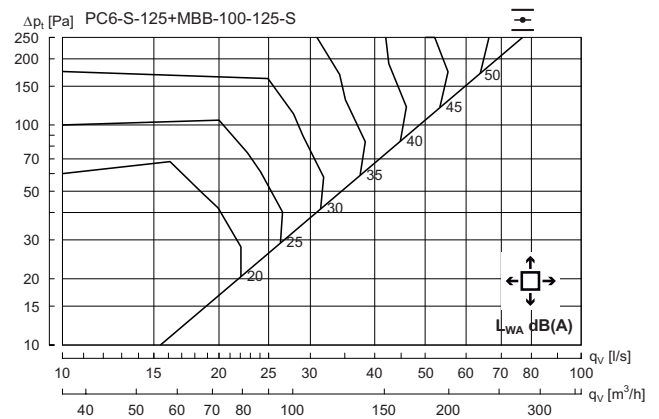

Hz	63	125	250	500	1K	2K	4K	8K
K_{ok}	10	6	1	-2	-5	-12	-18	-25

Perforated diffuser

PC6

Technical data

PC6 160 + MBB - Supply air

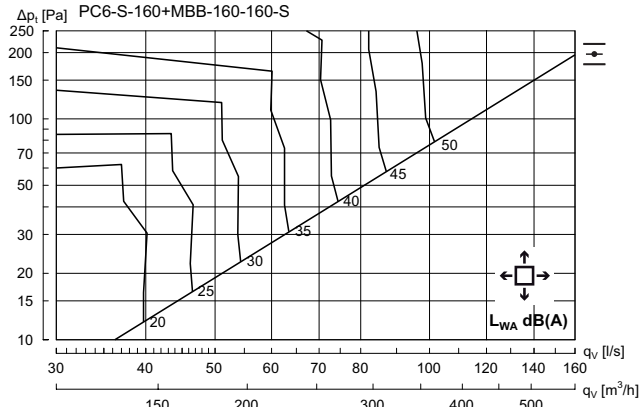

Hz	63	125	250	500	1K	2K	4K	8K
K_{ok}	10	3	-5	-1	-3	-15	-23	-29

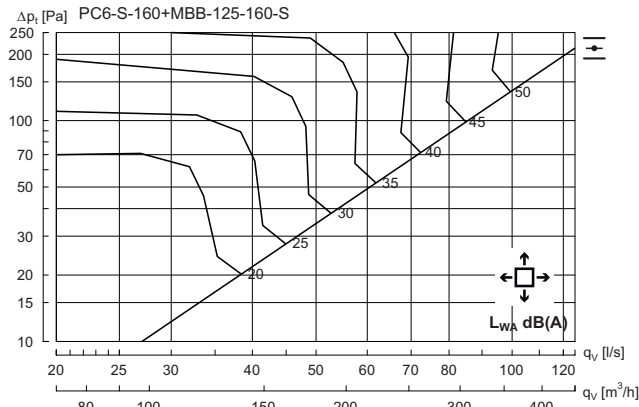

Hz	63	125	250	500	1K	2K	4K	8K
K_{ok}	9	5	0	-2	-5	-12	-17	-25

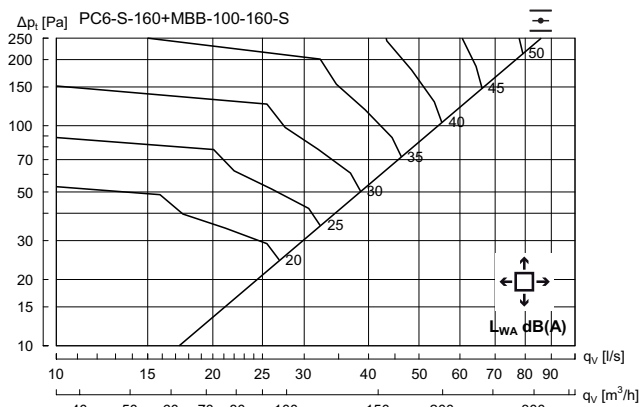

Hz	63	125	250	500	1K	2K	4K	8K
K_{ok}	7	4	0	-1	-5	-11	-16	-22

PC6 200 + MBB - Supply air

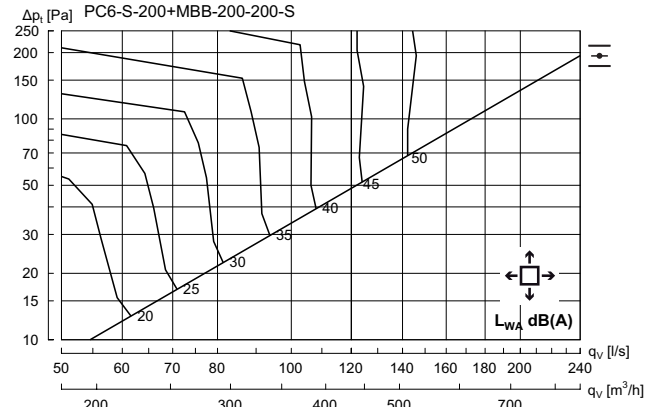

Hz	63	125	250	500	1K	2K	4K	8K
K_{ok}	11	2	-5	-1	-4	-15	-22	-27

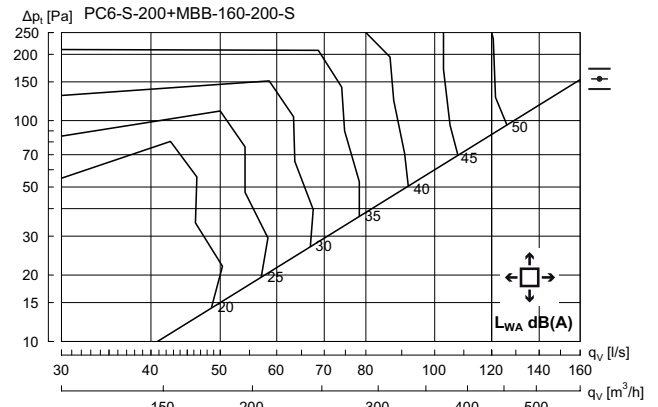

Hz	63	125	250	500	1K	2K	4K	8K
K_{ok}	11	4	-2	-2	-3	-12	-20	-27

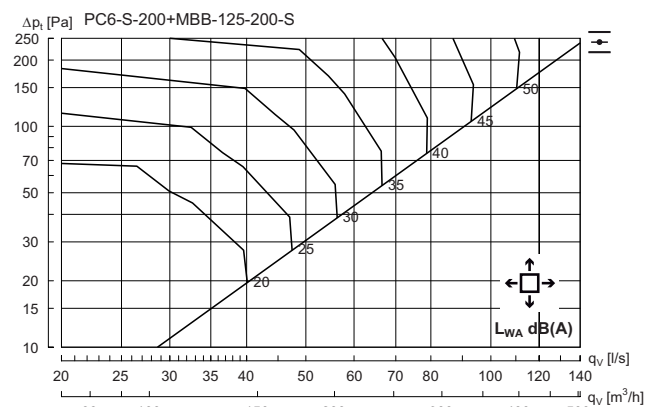

Hz	63	125	250	500	1K	2K	4K	8K
K_{ok}	6	5	0	-2	-5	-10	-16	-22

Perforated diffuser

PC6

Technical data

PC6 250 + MBB - Supply air

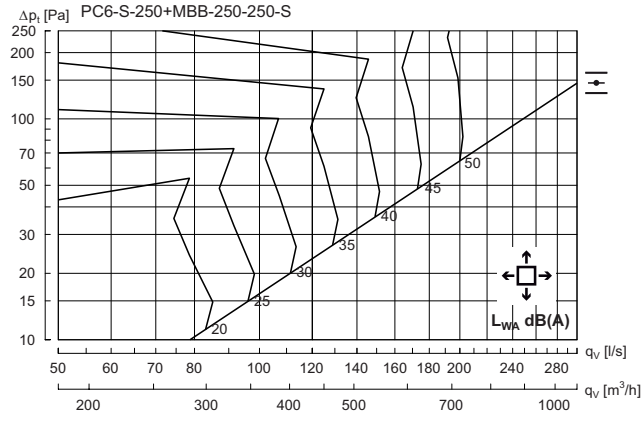

Hz	63	125	250	500	1K	2K	4K	8K
K_{ok}	9	-1	-6	0	-4	-16	-25	-30

PC6 315 + MBB - Supply air

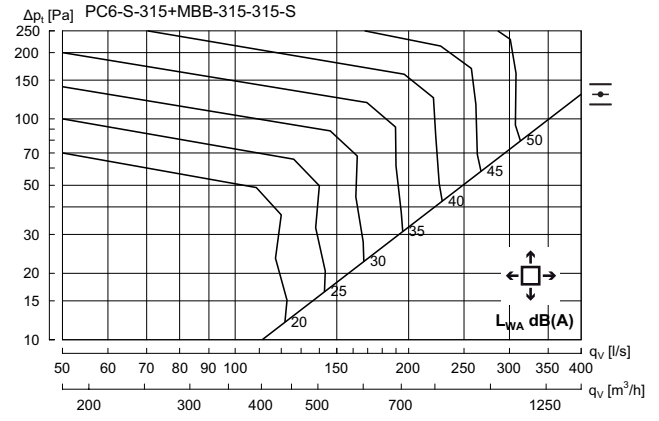

Hz	63	125	250	500	1K	2K	4K	8K
K_{ok}	13	1	-2	-2	-4	-13	-23	-29

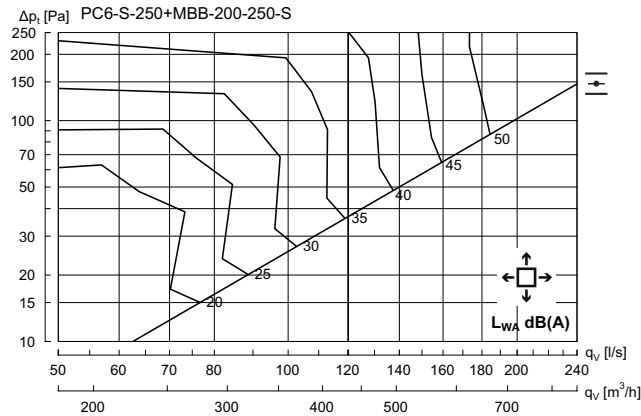

Hz	63	125	250	500	1K	2K	4K	8K
K_{ok}	11	3	-3	-2	-3	-14	-22	-29

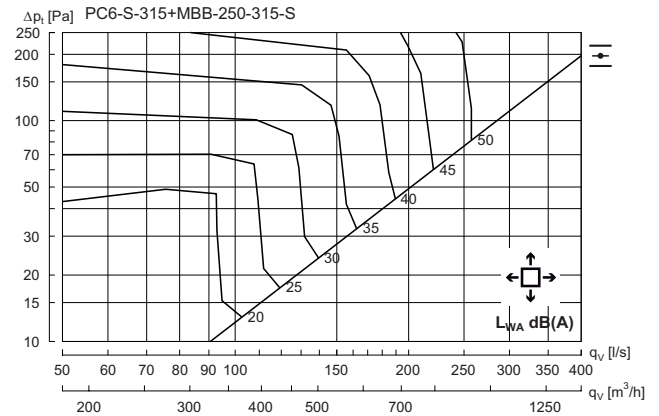

Hz	63	125	250	500	1K	2K	4K	8K
K_{ok}	11	2	-3	-2	-3	-13	-19	-26

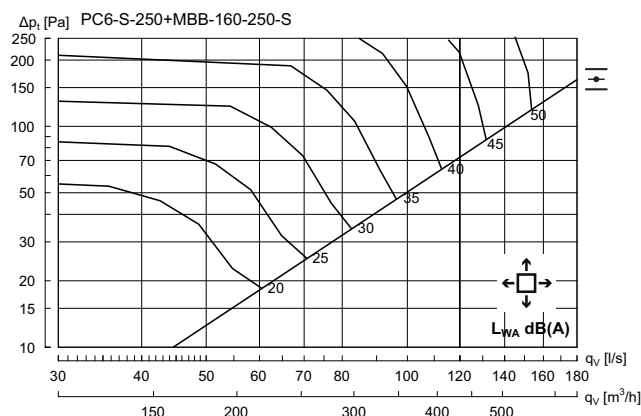

Hz	63	125	250	500	1K	2K	4K	8K
K_{ok}	12	3	-1	-4	-4	-10	-18	-24

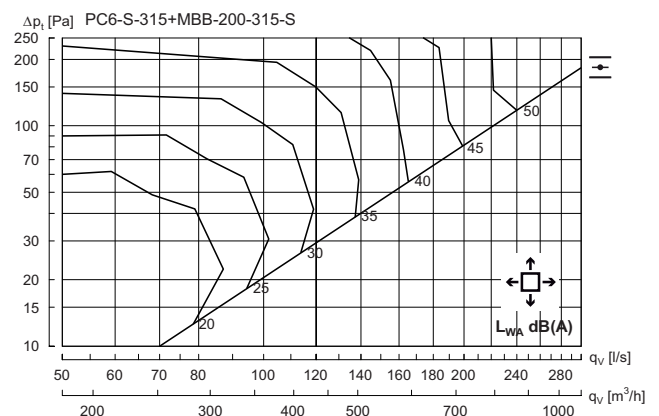

Hz	63	125	250	500	1K	2K	4K	8K
K_{ok}	10	6	-1	-2	-4	-12	-20	-26

Perforated diffuser

PC6

Technical data

PC6 without box - Exhaust air

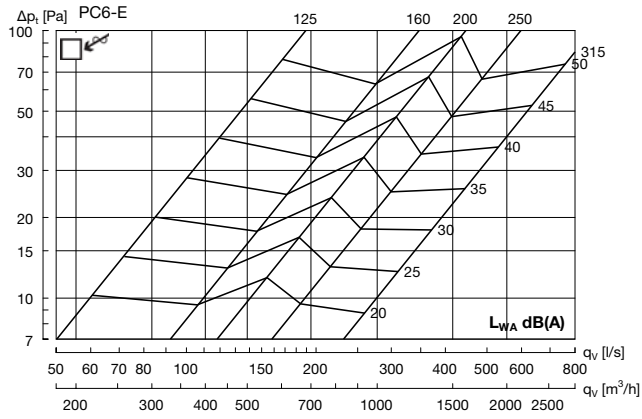

PC6 125 + MBB - Exhaust air

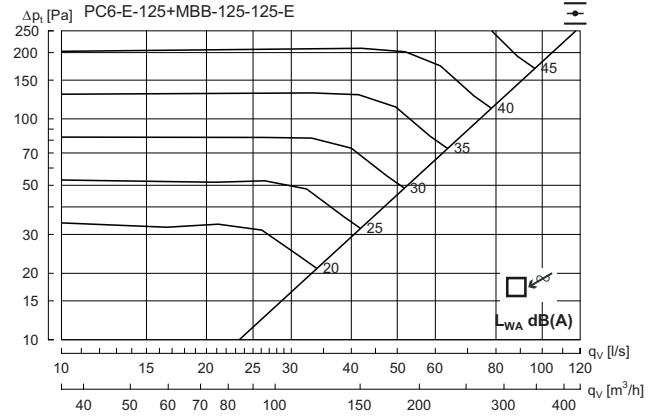

Hz	63	125	250	500	1K	2K	4K	8K
K_{ok}	12	5	0	-2	-5	-11	-14	-21

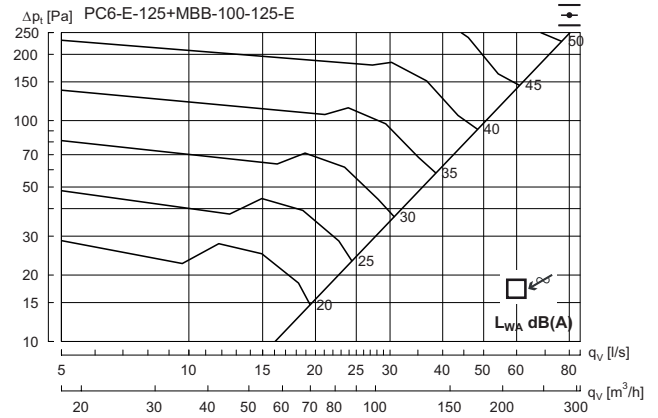

Hz	63	125	250	500	1K	2K	4K	8K
K_{ok}	11	-1	4	-2	-8	-11	-16	-23

- 1
- 2
- 3
- 4
- 5
- 6
- 7
- 8
- 9
- 10
- 11
- 12
- 13
- 14
- 15
- 16
- 17
- 18

Perforated diffuser

PC6

Technical data

PC6 160 + MBB - Exhaust air

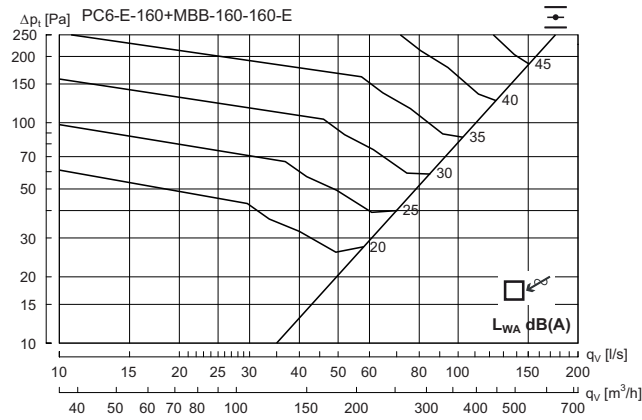

Hz	63	125	250	500	1K	2K	4K	8K
K_{ok}	20	8	-1	-4	-6	-12	-18	-21

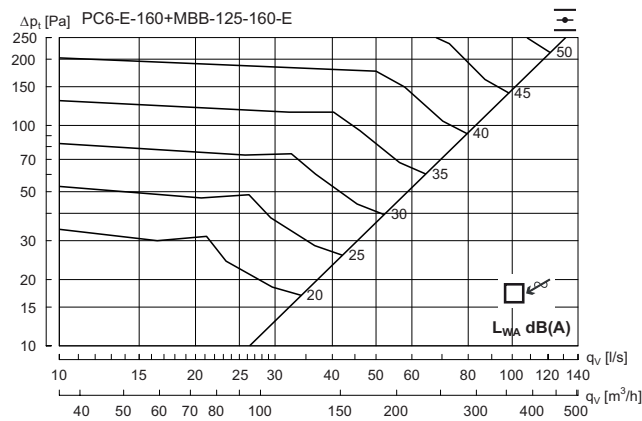

Hz	63	125	250	500	1K	2K	4K	8K
K_{ok}	12	6	1	-2	-6	-11	-14	-21

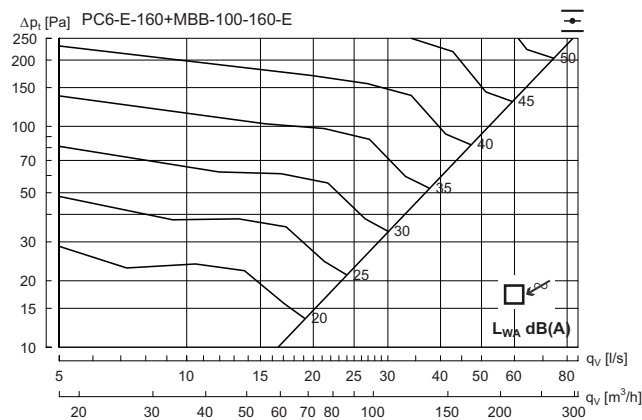

Hz	63	125	250	500	1K	2K	4K	8K
K_{ok}	9	3	3	-1	-8	-11	-16	-22

PC6 200+ MBB - Exhaust air

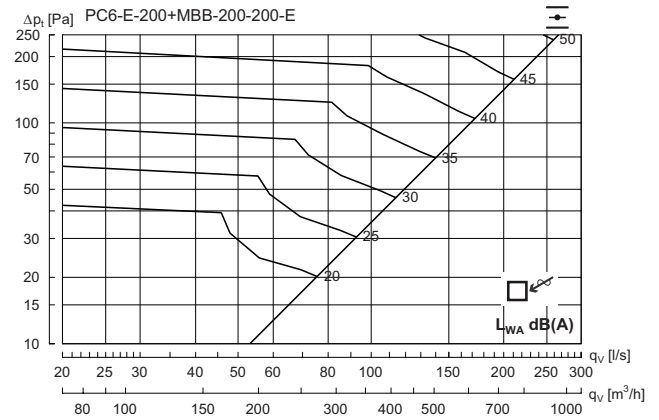

Hz	63	125	250	500	1K	2K	4K	8K
K_{ok}	14	4	0	-3	-5	-9	-15	-23

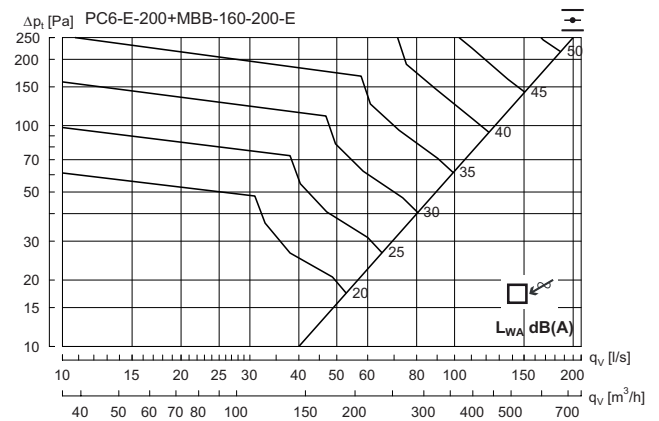

Hz	63	125	250	500	1K	2K	4K	8K
K_{ok}	15	6	-1	-3	-5	-9	-15	-21

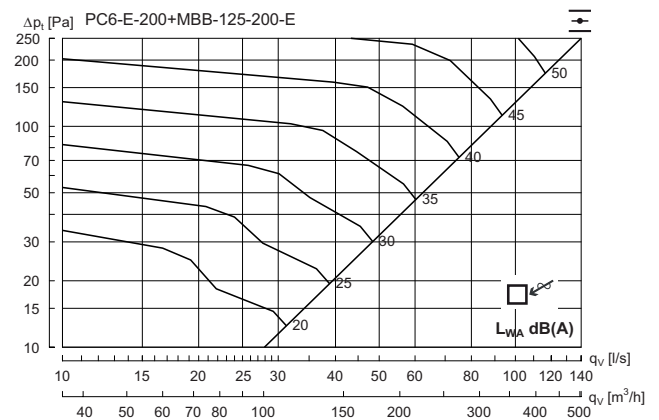

Hz	63	125	250	500	1K	2K	4K	8K
K_{ok}	10	3	1	-2	-5	-10	-16	-22

Perforated diffuser

PC6

Technical data

PC6 250+ MBB - Exhaust air

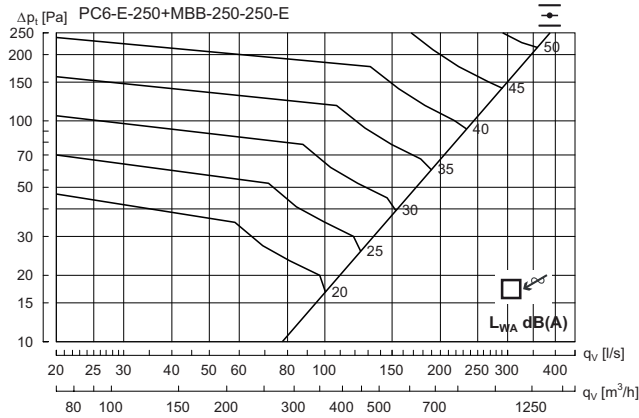

Hz	63	125	250	500	1K	2K	4K	8K
K_{ok}	10	5	2	-3	-5	-11	-17	-24

PC6 315+ MBB - Exhaust air

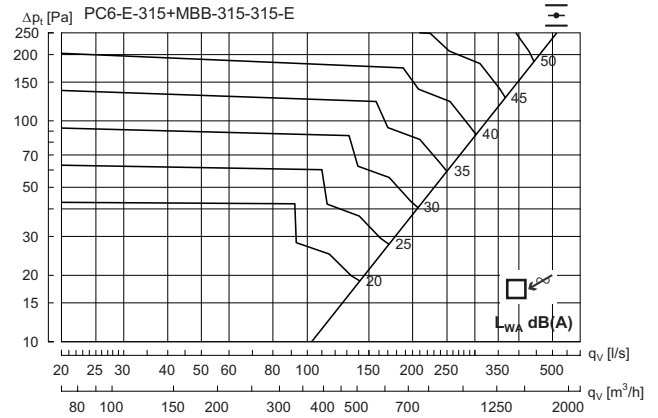

Hz	63	125	250	500	1K	2K	4K	8K
K_{ok}	13	5	3	-3	-6	-10	-16	-27

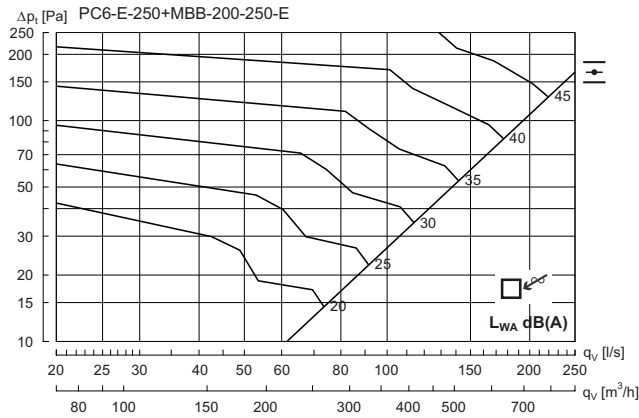

Hz	63	125	250	500	1K	2K	4K	8K
K_{ok}	13	4	0	-3	-5	-10	-14	-21

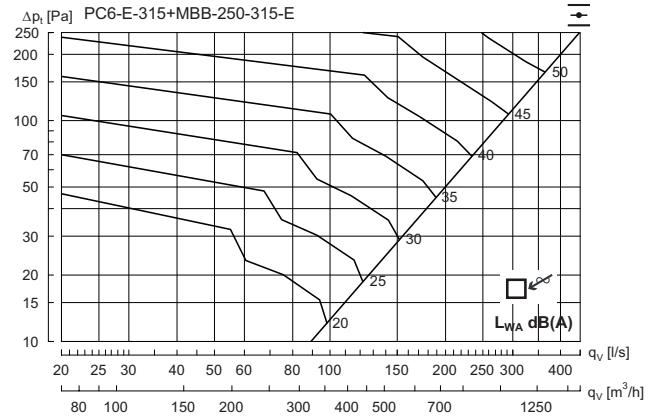

Hz	63	125	250	500	1K	2K	4K	8K
K_{ok}	8	5	2	-3	-5	-11	-17	-25

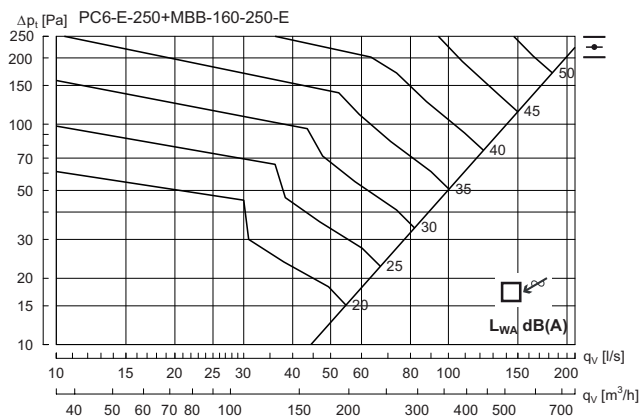

Hz	63	125	250	500	1K	2K	4K	8K
K_{ok}	14	6	0	-4	-6	-9	-14	-19

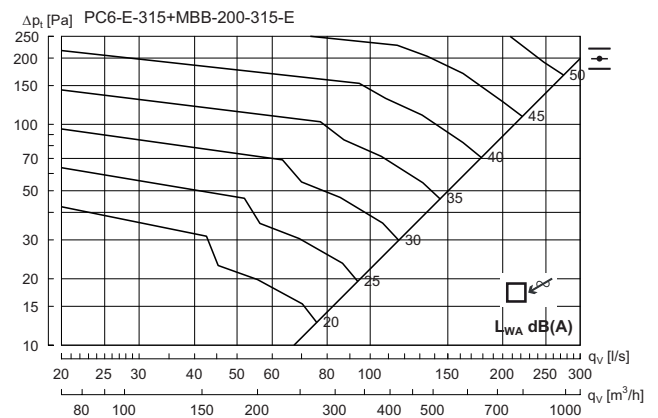

Hz	63	125	250	500	1K	2K	4K	8K
K_{ok}	13	5	1	-3	-5	-9	-14	-22

Perforated diffuser

PC7



Description

PC7 is a circular diffuser with perforated face plate and integrated swirl insert. The diffuser is suitable for the horizontal supply of very cold air. The integrated swirl insert ensures optimum distribution and high induction. Installing this diffuser in a plenum box type MBB can help to achieve a stable flow of air to the diffuser as well as realise the potential for individual adjustment.

- High induction
- Discrete design
- Suitable for cooling at very low temperatures

Maintenance

The face plate and swirl insert can be removed to enable cleaning of internal parts or to gain access to the duct or box. The visible parts of the diffuser can be wiped with a damp cloth.

Order code

Product Type	PC7	S	aaa
Functional use			
S = Supply air			
Connection dim.			
Ød 160-315			

Example: PC7-S-200

Dimensions

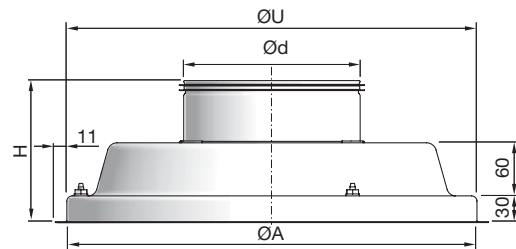

PC7 Ød mm	ØA mm	H mm	ØU* mm	Weight kg
160	460	140	470	5.30
200	460	140	470	5.40
250	540	140	550	7.40
315	540	140	550	8.10

* ØU = ceiling grid opening

Ød 315, No mounting holes for MBB !

PC7-S



Materials and finish

Material: Galvanised steel
 Standard finish: Powder-coated
 Standard colour: RAL 9003, 9010 Gloss 30

The diffuser is available in other colours. Please contact Lindab's sales department for further information.

Perforated diffuser

PC7

Accessories

Mounting brackets

DCZ

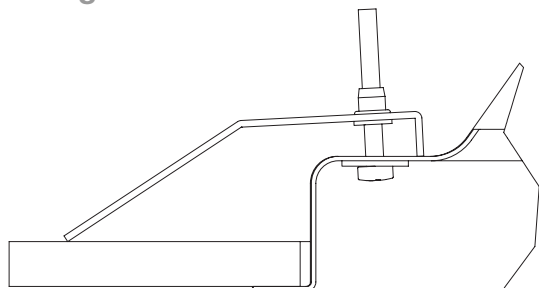

Plenum box

MBB



Extension piece

MBZ

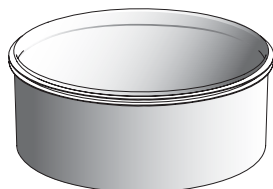

PC7 + MBB

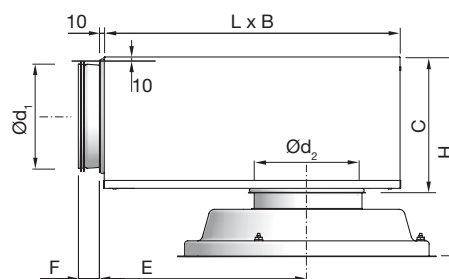

Order code - accessories

Product	aaa	bbb
Type		
Size		

Example: DCZ-200

PC7 + MBB		B	C	E	F	H*	L
duct	PC7	mm	mm	mm	mm	mm	mm
Ød ₁ mm	Ød ₂ mm						
100	160	260	159	216	50	250 - 290	310
125	160	310	184	262	50	275 - 315	376
125	200	310	184	262	50	275 - 315	376
160	160	380	220	323	50	309 - 349	459
160	200	380	220	323	50	309 - 349	459
160	250	380	220	323	50	309 - 349	459
200	200	460	259	396	70	350 - 390	565
200	250	460	259	396	70	350 - 390	565
200	315	460	259	396	70	350 - 390	565
250	250	540	309	486	70	400 - 440	698
250	315	540	309	486	70	400 - 440	698
315	315	540	373	646	70	465 - 505	858

* Using accessory MBZ the H dimension will increase:

Ød₂ = 160 - 200 mm => H +40 mm

Ød₂ = 250 - 315 mm => H +60 mm

Module plate

LM



Order code - module plate

Product	LM	a	PC7	ccc
Type				
Ceiling system				
Diffuser				
Size				

Example: LM-1-PC7-200

Ceiling system - see introductory summary.

Order code

Product	MBB	aaa	bbb	S
Type				
MBB				
Duct connection Ød ₁				
Ø100-315				
Diffuser dimension Ød ₂				
Ø160-315				
Functional use				
S = Supply air				

Example: PC7-S-200-MBB-160-200-S

Perforated diffuser

PC7

Technical data

Capacity

Air flow q_v [l/s] and [m³/h], total pressure Δp_t [Pa], throw $l_{0,2}$ [m] and sound power level L_{WA} [dB(A)] can be seen in the diagrams.

Frequency-related sound effect level

The sound effect level in the frequency band is defined as $L_{WA} + K_{ok}$. K_{ok} values are specified in charts beneath the diagrams on the following pages.

Quick selection, supply air

PC7 + MBB		$\Delta p_t \geq 50$ Pa 30 dB(A)		$\Delta p_t \geq 50$ Pa 35 dB(A)	
duct $\varnothing d_1$	PC7 $\varnothing d_2$	l/s	m ³ /h	l/s	m ³ /h
100	160	36	130	43	155
125	160	44	158	55	198
125	200	50	180	60	216
160	160	47	169	55	198
160	200	55	198	66	238
160	250	71	256	88	317
200	200	60	216	72	259
200	250	84	302	99	356
200	315	93	335	113	407
250	250	88	317	103	371
250	315	96	346	114	410
315	315	107	385	127	457

Throw $l_{0,2}$

Throw $l_{0,2}$ [m] is specified at a terminal velocity of 0.2 m/s.

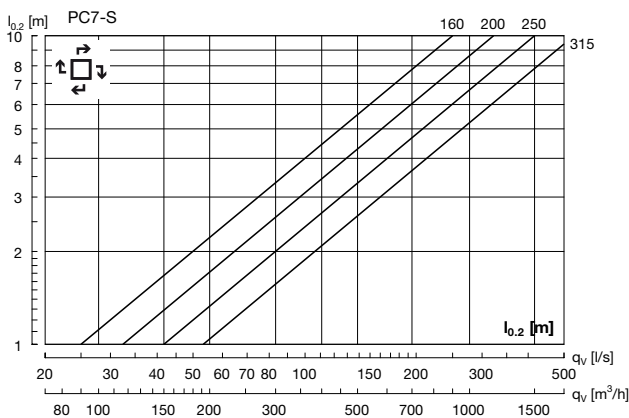

Sound attenuation

Sound attenuation of the diffusers ΔL from duct to room, including end reflection - see table below.

PC7 + MBB		Centre frequency Hz							
duct $\varnothing d_1$	PC7 $\varnothing d_2$	63	125	250	500	1K	2K	4K	8K
100	160	17	15	5	12	18	17	17	19
125	160	15	14	7	18	16	17	18	20
125	200	12	11	4	14	14	16	16	18
160	160	17	15	10	21	18	19	20	20
160	200	18	15	8	21	17	17	19	20
160	250	17	14	4	16	14	16	18	19
200	200	14	10	8	16	19	16	20	18
200	250	12	10	6	14	17	15	18	17
200	315	12	8	4	10	16	14	17	16
250	250	13	9	8	15	17	17	18	18
250	315	13	7	6	14	16	16	17	17
315	315	9	9	9	14	17	16	17	22

Balancing

Balancing data is contained in a separate brochure.

Perforated diffuser

PC7

Technical data

PC7 without box - Supply air

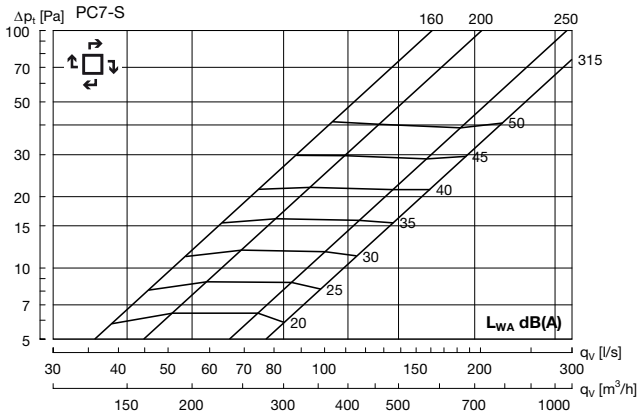

PC7 160 + MBB - Supply air

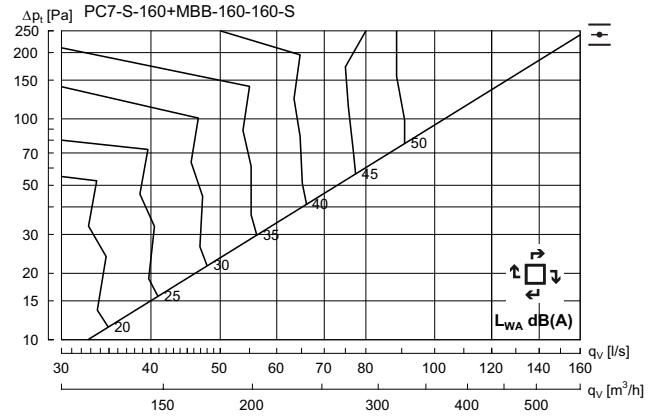

Hz	63	125	250	500	1K	2K	4K	8K
K_{ok}	10	1	-4	-1	-3	-18	-26	-32

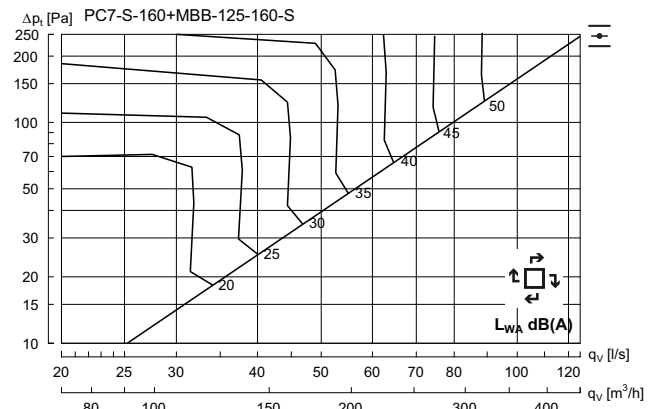

Hz	63	125	250	500	1K	2K	4K	8K
K_{ok}	10	4	-1	-1	-5	-14	-19	-25

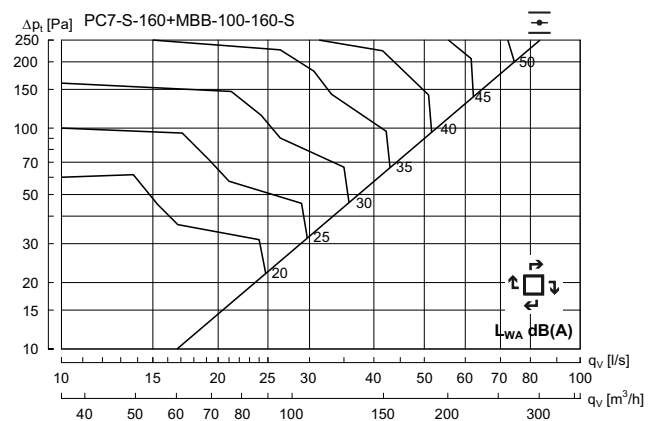

Hz	63	125	250	500	1K	2K	4K	8K
K_{ok}	11	3	0	-1	-6	-10	-14	-20

Perforated diffuser

PC7

Technical data

PC7 200 + MBB - Supply air

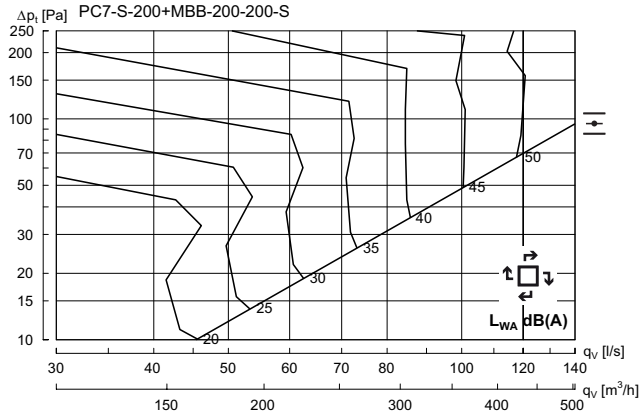

Hz	63	125	250	500	1K	2K	4K	8K
K_{ok}	11	-1	-4	0	-4	-19	-26	-31

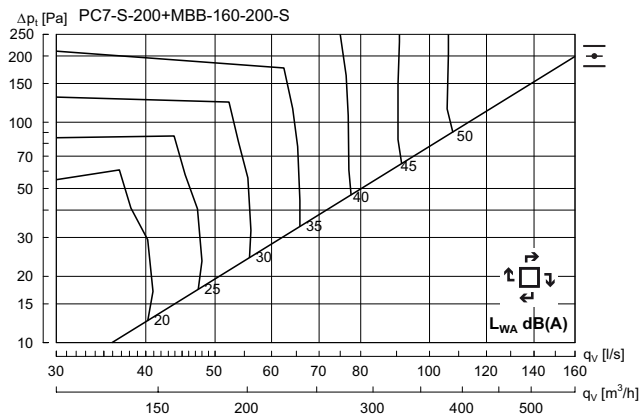

Hz	63	125	250	500	1K	2K	4K	8K
K_{ok}	11	2	-2	-1	-4	-16	-24	-29

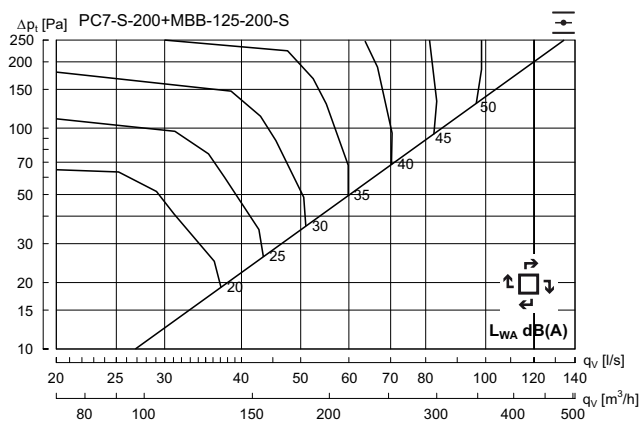

Hz	63	125	250	500	1K	2K	4K	8K
K_{ok}	6	5	1	-1	-5	-13	-19	-24

PC7 250 + MBB - Supply air

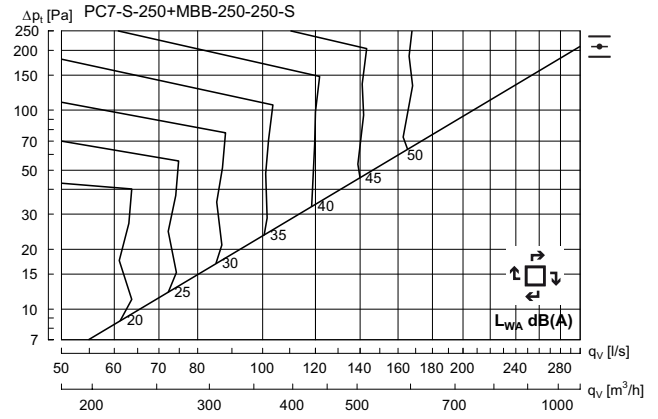

Hz	63	125	250	500	1K	2K	4K	8K
K_{ok}	12	-1	-5	0	-4	-18	-28	-36

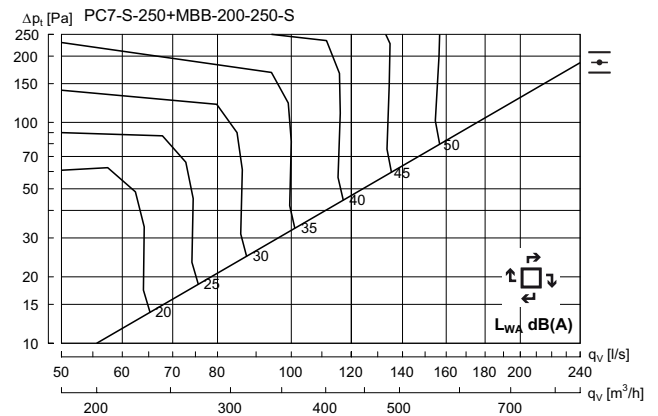

Hz	63	125	250	500	1K	2K	4K	8K
K_{ok}	13	2	-3	-1	-4	-16	-24	-29

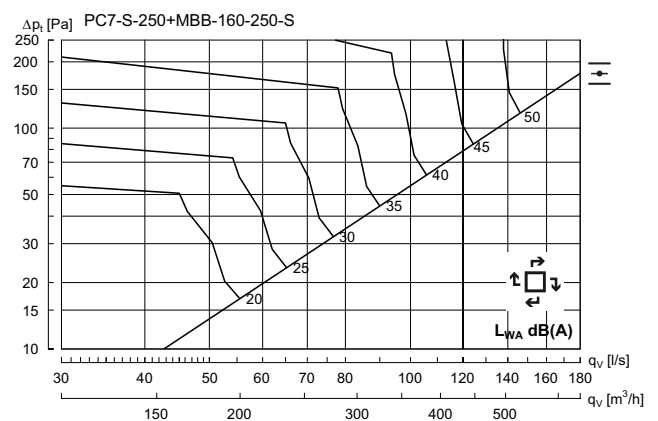

Hz	63	125	250	500	1K	2K	4K	8K
K_{ok}	12	4	1	-2	-4	-13	-20	-26

Perforated diffuser

PC7

Technical data

PC7 315 + MBB - Supply air

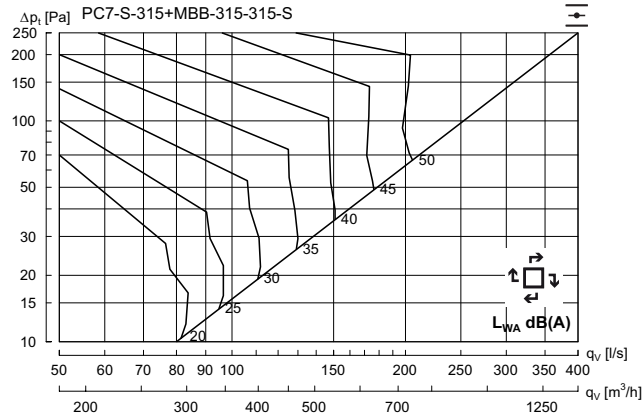

Hz	63	125	250	500	1K	2K	4K	8K
K_{ok}	12	1	-2	0	-5	-18	-23	-32

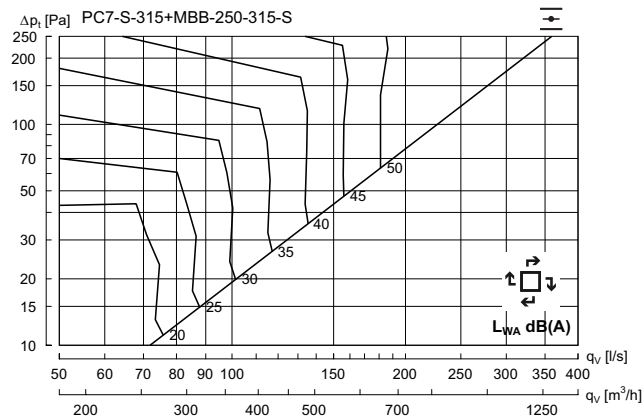

Hz	63	125	250	500	1K	2K	4K	8K
K_{ok}	9	0	-2	0	-4	-16	-25	-34

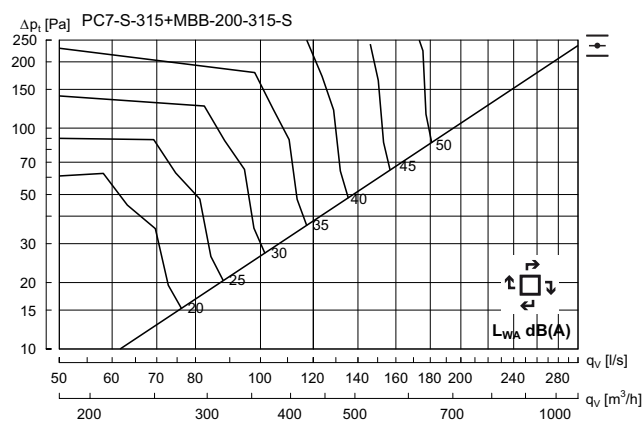

Hz	63	125	250	500	1K	2K	4K	8K
K_{ok}	12	4	-1	-1	-4	-14	-21	-27

Swirl diffuser

RC14



Dimensions

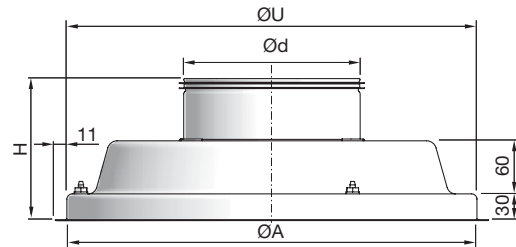

RC14 Ød	ØA	H	ØU*	Weight
mm	mm	mm	mm	kg
160	360	140	370	5.30
200	360	140	370	5.40
250	460	140	470	7.40
315	540	140	550	8.10

* ØU = ceiling grid opening

Ød 315, No mounting holes for MBB !

RC14

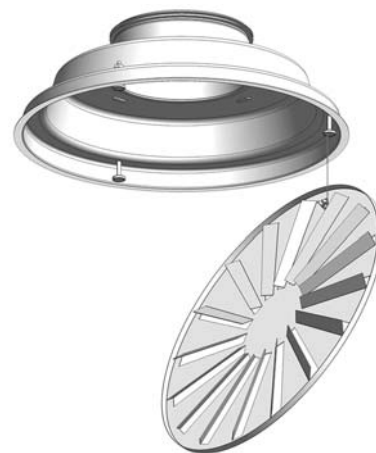

Description

RC14 is a circular swirl diffuser with fixed bars. The diffuser can be used for both supply air and exhaust. The swirl pattern ensures high induction and a large dynamic range, and is therefore ideal for the horizontal supply of very cold air. Installing this diffuser in a plenum box type MBB can help to achieve a stable flow of air to the diffuser as well as realise the potential for individual adjustment.

- Large dynamic range
- High induction
- Suitable for cooling at very low temperatures
- Can be used for both supply and exhaust air.

Maintenance

The face plate and swirl insert can be removed to enable cleaning of internal parts or to gain access to the duct or box. The visible parts of the diffuser can be wiped with a damp cloth.

Order code

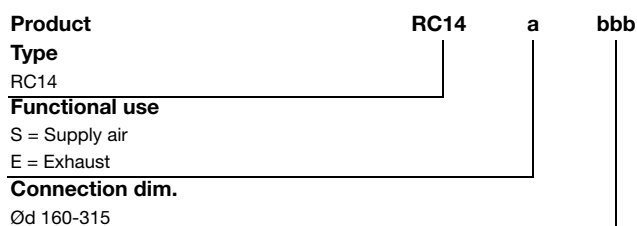

Example: RC14-S-250

Materials and finish

Material: Galvanised steel
 Standard finish: Powder-coated
 Standard colour: RAL 9010 Gloss 30

The diffuser is available in other colours. Please contact Lindab's sales department for further information.

Swirl diffuser

RC14

Accessories

Mounting brackets

DCZ

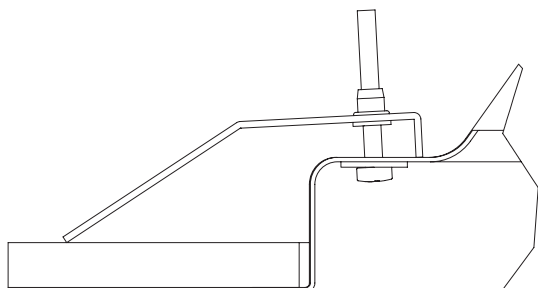

Extension piece

MBZ

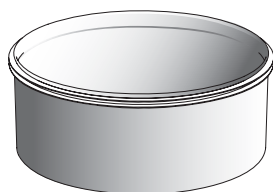

Order code - accessories

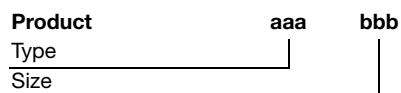

Example: DCZ-250

Module plate

LM



Order code - module plate

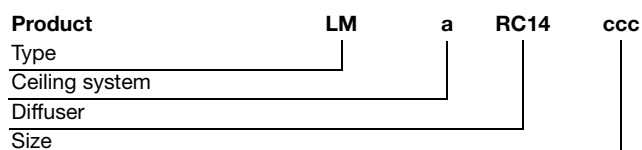

Example: LM-1-RC14-250

Ceiling system - see introductory summary.

Dimensions

Plenum box

MBB



RC14 + MBB

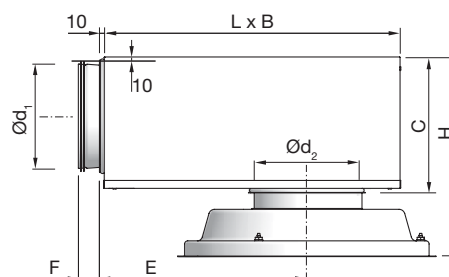

RC14 + MBB		B	C	E	F	H*	L
duct	RC14	mm	mm	mm	mm	mm	mm
Ød ₁	Ød ₂						
100	160	260	159	216	50	250 - 290	310
125	160	310	184	262	50	275 - 315	376
125	200	310	184	262	50	275 - 315	376
160	160	380	220	323	50	309 - 349	459
160	200	380	220	323	50	309 - 349	459
160	250	380	220	323	50	309 - 349	459
200	200	460	259	396	70	350 - 390	565
200	250	460	259	396	70	350 - 390	565
200	315	460	259	396	70	350 - 390	565
250	250	540	309	486	70	400 - 440	698
250	315	540	309	486	70	400 - 440	698
315	315	540	373	646	70	465 - 505	858

* Using accessory MBZ the H dimension will increase:

Ød₂ = 160 - 200 mm => H +40 mm

Ød₂ = 250 - 315 mm => H +60 mm

Order code

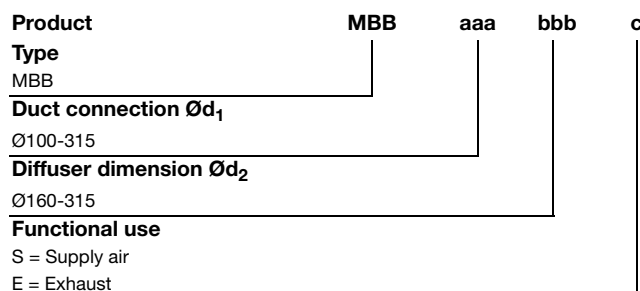

Example: RC14-S-250-MBB-200-250-S

Swirl diffuser

RC14

Technical data

Capacity

Air flow q_v [l/s] and [m³/h], total pressure Δp_t [Pa], throw $l_{0.2}$ [m] and sound power level L_{WA} [dB(A)] can be seen in the diagrams.

Frequency-related sound effect level

The sound effect level in the frequency band is defined as $L_{WA}+K_{ok}$. K_{ok} values are specified in charts beneath the diagrams on the following pages.

Quick selection, supply air

RC14 + MBB		$\Delta p_t \geq 50$ Pa		$\Delta p_t \geq 50$ Pa	
duct	RC14	30 dB(A)		35 dB(A)	
$\varnothing d_1$	$\varnothing d_2$	l/s	m ³ /h	l/s	m ³ /h
100	160	37	133	44	158
125	160	44	158	54	194
125	200	50	180	62	223
160	160	48	173	57	205
160	200	56	202	67	241
160	250	67	241	84	302
200	200	62	223	74	266
200	250	82	295	96	346
200	315	102	367	126	454
250	250	92	331	106	382
250	315	117	421	139	500
315	315	141	508	166	598

Throw $l_{0.2}$

Throw $l_{0.2}$ [m] is specified at a terminal velocity of 0.2 m/s.

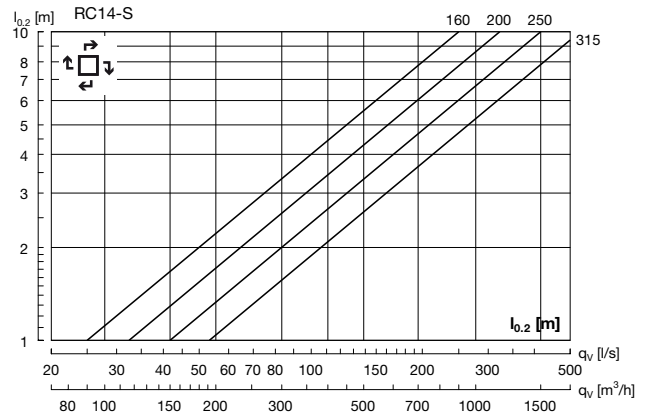

Sound attenuation

Sound attenuation of the diffusers ΔL from duct to room, including end reflection - see table below.

RC14 + MBB		Centre frequency Hz							
duct	RC14	63	125	250	500	1K	2K	4K	8K
$\varnothing d_1$	$\varnothing d_2$								
100	160	18	15	5	11	18	19	18	19
125	160	15	13	8	17	17	17	18	20
125	200	13	11	6	13	14	17	17	19
160	160	16	15	11	21	18	20	21	20
160	200	17	15	9	21	18	19	20	20
160	250	17	14	4	18	14	16	18	19
200	200	14	11	8	15	19	17	20	18
200	250	14	10	5	14	18	14	18	17
200	315	14	8	3	10	16	15	17	16
250	250	14	9	7	15	18	17	19	18
250	315	12	7	6	14	16	15	17	17
315	315	8	9	9	13	17	16	18	22

Balancing

Balancing data is contained in a separate brochure.

Swirl diffuser

RC14

Technical data

RC14 without box – supply air

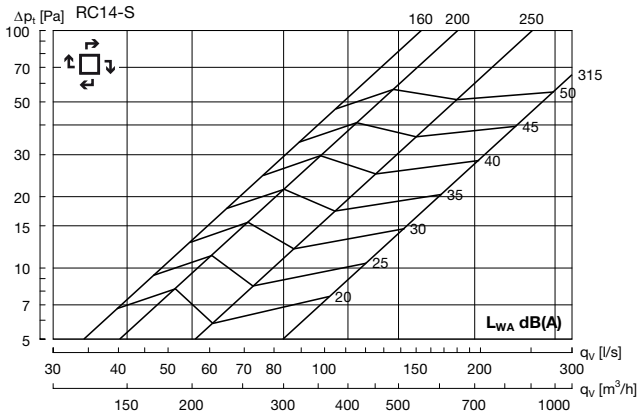

RC14 - 160 + MBB - Supply air

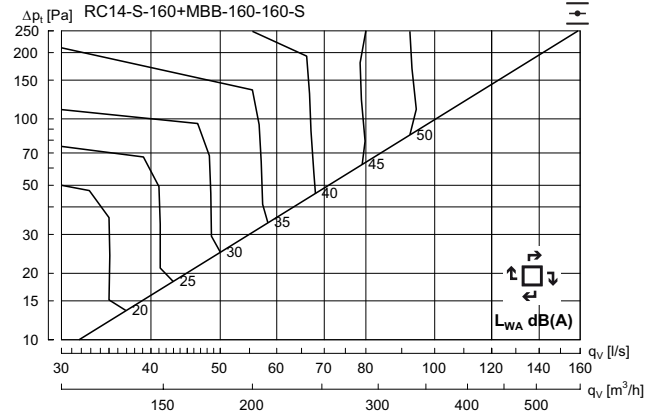

Hz	63	125	250	500	1K	2K	4K	8K
K_{ok}	6	2	-3	0	-4	-15	-26	-32

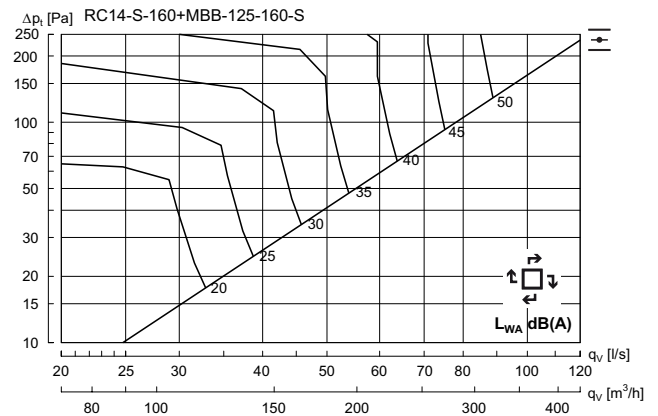

Hz	63	125	250	500	1K	2K	4K	8K
K_{ok}	9	5	0	-1	-5	-13	-19	-25

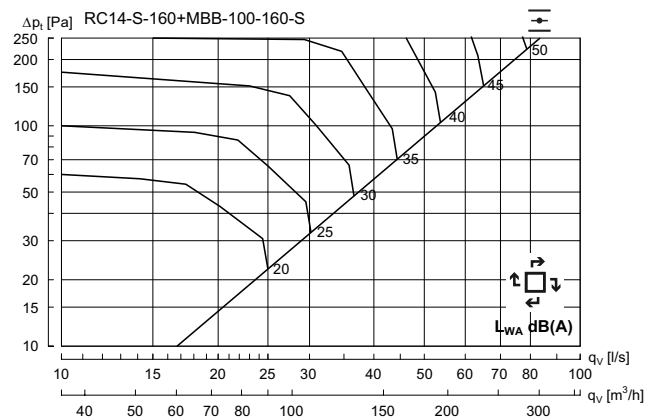

Hz	63	125	250	500	1K	2K	4K	8K
K_{ok}	9	4	0	0	-6	-12	-16	-20

Swirl diffuser

RC14

Technical data

RC14 - 200 + MBB - Supply air

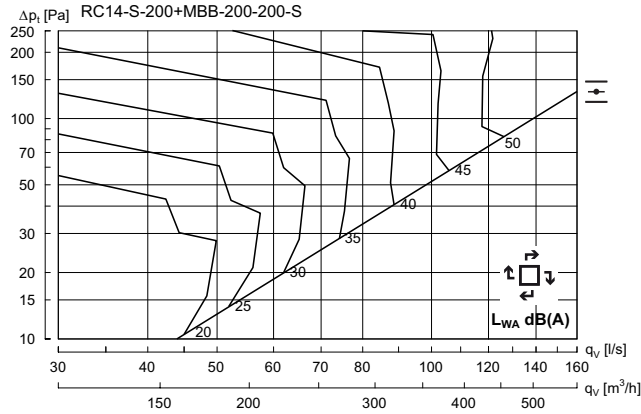

Hz	63	125	250	500	1K	2K	4K	8K
K_{ok}	11	3	-3	-1	-5	-12	-24	-33

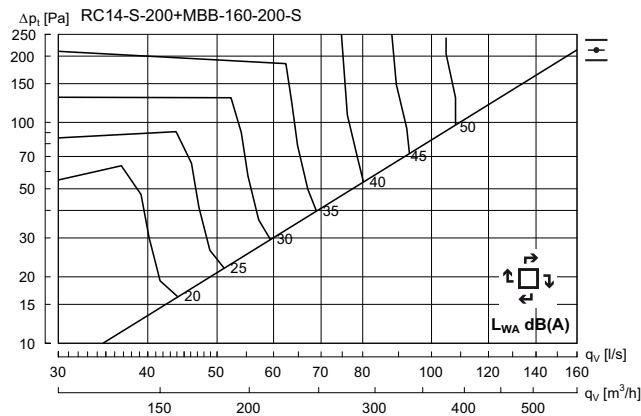

Hz	63	125	250	500	1K	2K	4K	8K
K_{ok}	14	4	-2	-2	-4	-12	-22	-30

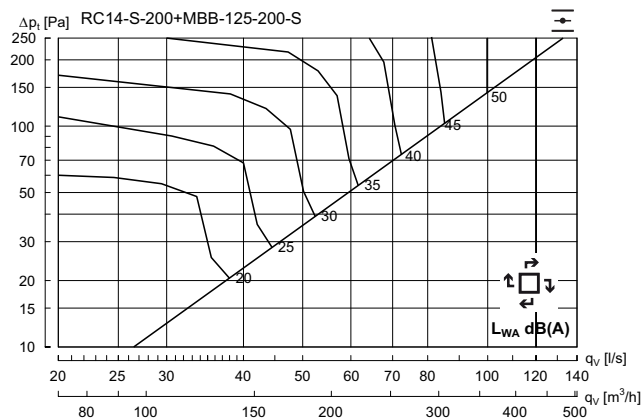

Hz	63	125	250	500	1K	2K	4K	8K
K_{ok}	8	6	1	-2	-6	-12	-17	-23

RC14 - 250 + MBB - Supply air

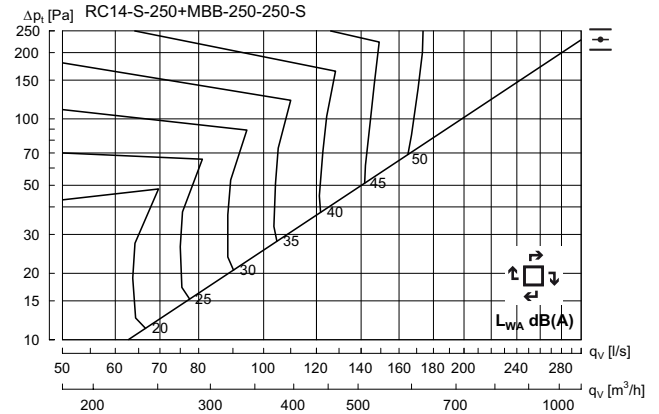

Hz	63	125	250	500	1K	2K	4K	8K
K_{ok}	10	1	-4	-1	-4	-14	-26	-37

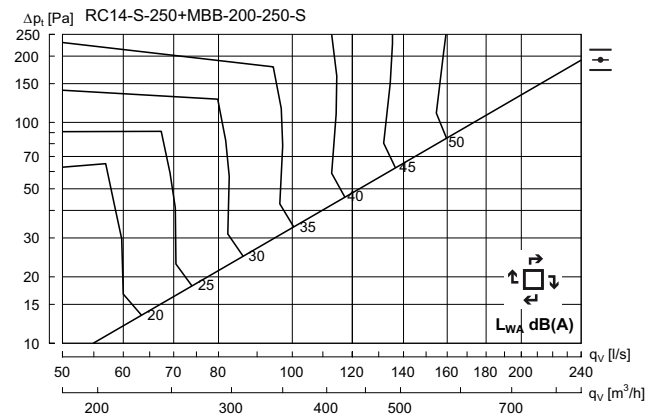

Hz	63	125	250	500	1K	2K	4K	8K
K_{ok}	9	5	-3	-2	-3	-12	-24	-32

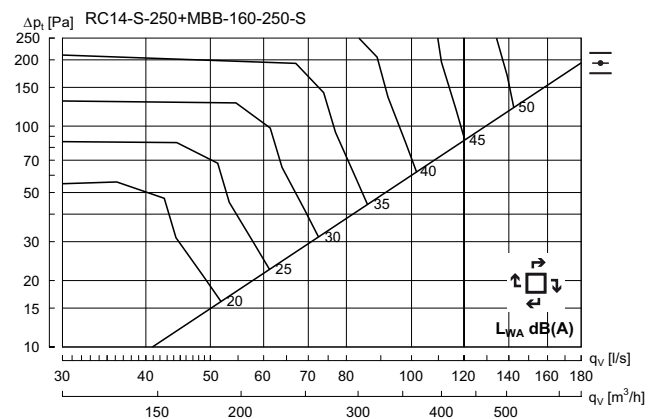

Hz	63	125	250	500	1K	2K	4K	8K
K_{ok}	13	4	-1	-3	-4	-13	-21	-26

Swirl diffuser

RC14

Technical data

RC14 - 315 + MBB - Supply air

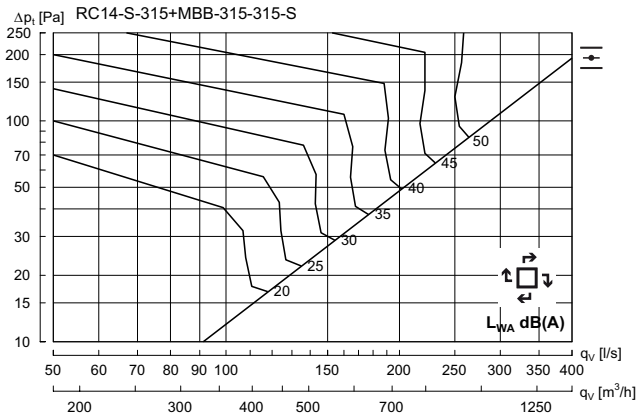

Hz	63	125	250	500	1K	2K	4K	8K
K_{ok}	14	3	-1	-1	-4	-13	-24	-33

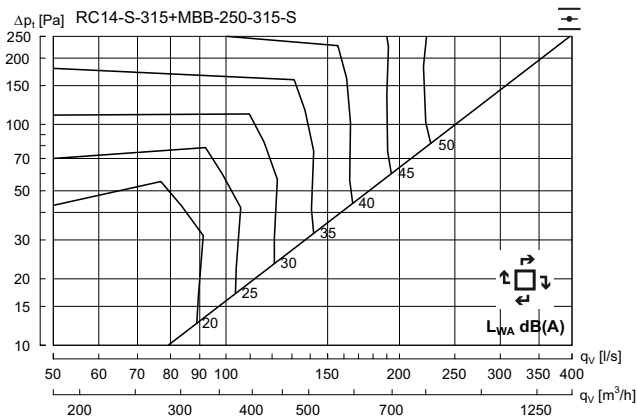

Hz	63	125	250	500	1K	2K	4K	8K
K_{ok}	11	3	-2	-2	-4	-11	-21	-30

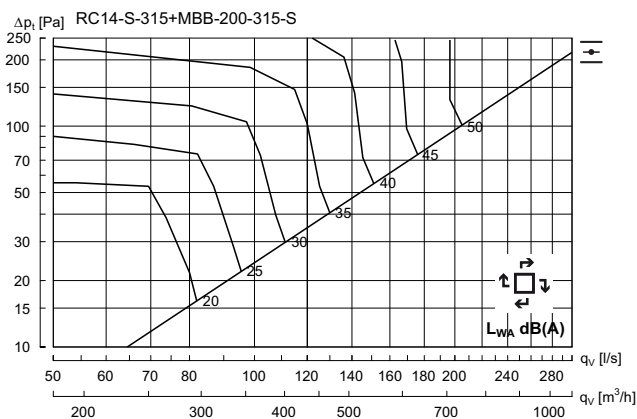

Hz	63	125	250	500	1K	2K	4K	8K
K_{ok}	10	7	-1	-2	-4	-13	-21	-27

Swirl diffuser

RC14

Technical data

RC14 without box – Exhaust air

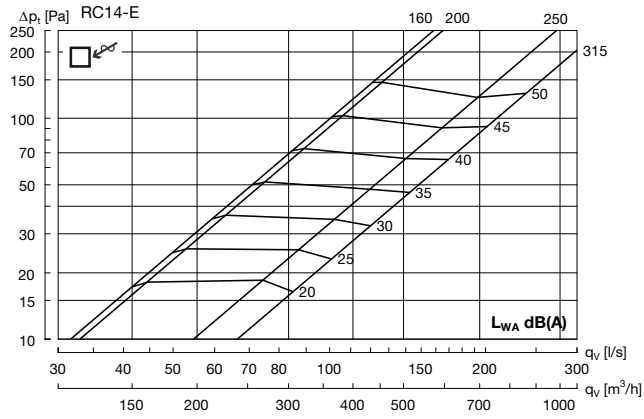

RC14 - 160 + MBB - Exhaust air

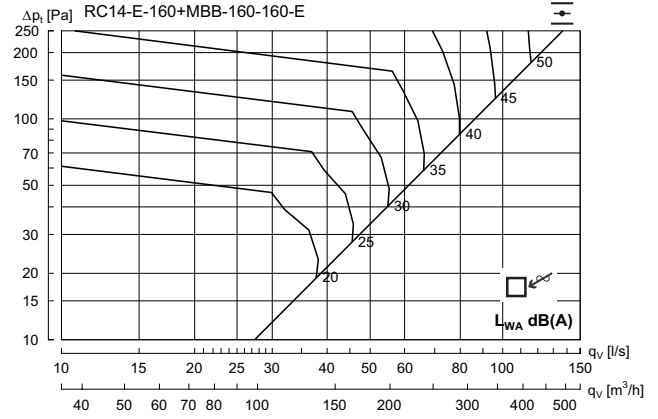

Hz	63	125	250	500	1K	2K	4K	8K
K _{ok}	14	4	-2	-2	-4	-13	-20	-26

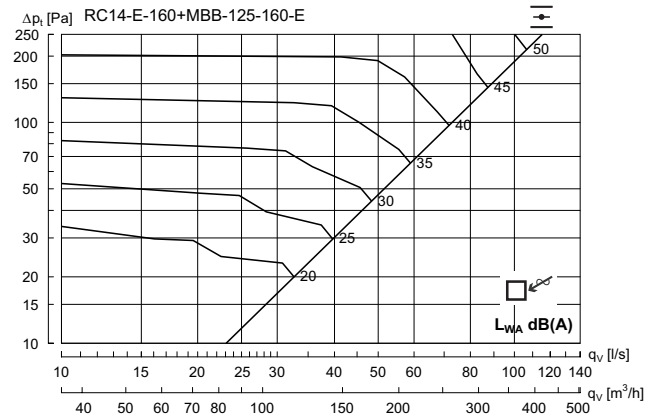

Hz	63	125	250	500	1K	2K	4K	8K
K _{ok}	13	6	1	-1	-6	-13	-16	-22

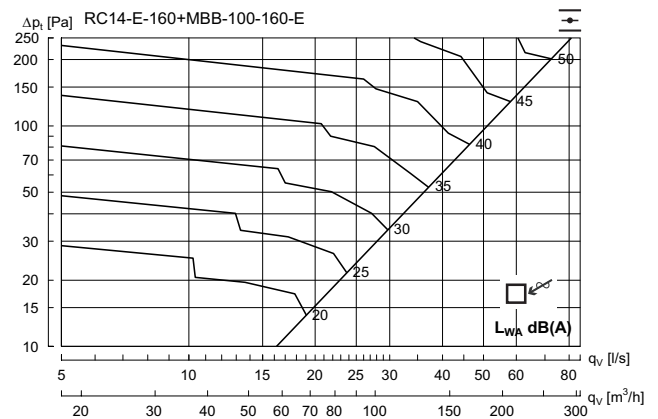

Hz	63	125	250	500	1K	2K	4K	8K
K _{ok}	9	0	4	-1	-10	-12	-18	-24

Swirl diffuser

RC14

Technical data

RC14 - 200 + MBB - Exhaust air

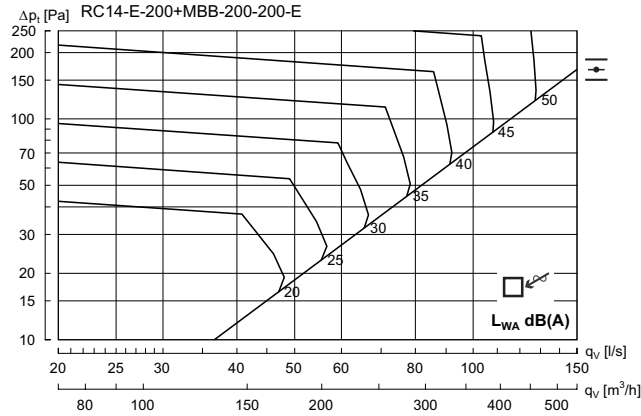

Hz	63	125	250	500	1K	2K	4K	8K
K_{ok}	13	2	-4	-2	-3	-13	-22	-31

RC14 - 250 + MBB - Exhaust air

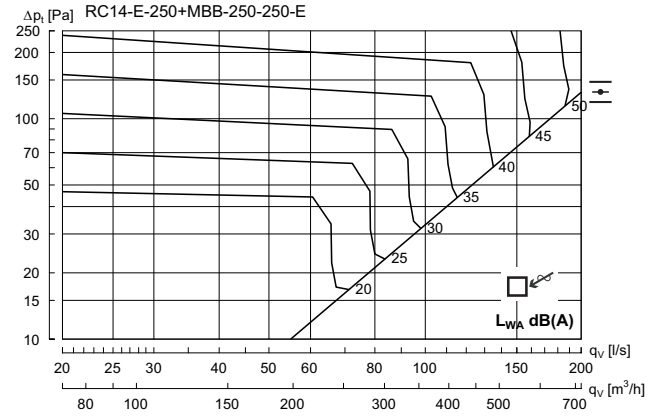

Hz	63	125	250	500	1K	2K	4K	8K
K_{ok}	13	4	0	-2	-4	-12	-22	-31

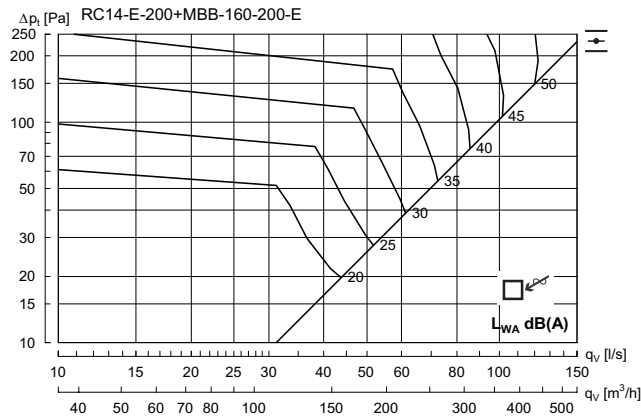

Hz	63	125	250	500	1K	2K	4K	8K
K_{ok}	16	5	-2	-3	-4	-12	-21	-26

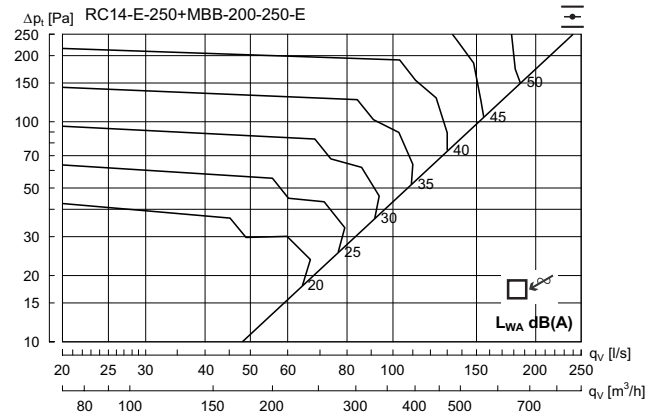

Hz	63	125	250	500	1K	2K	4K	8K
K_{ok}	12	4	0	-2	-4	-11	-19	-27

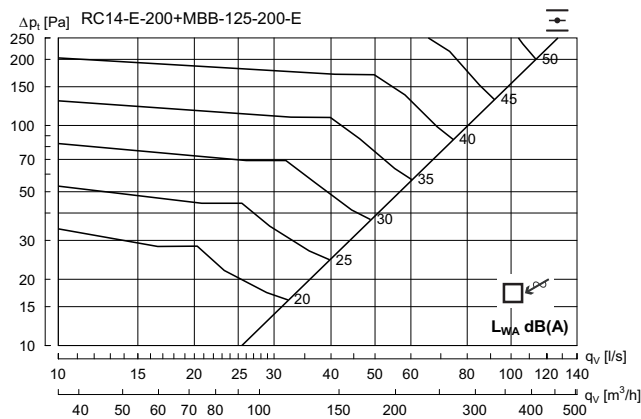

Hz	63	125	250	500	1K	2K	4K	8K
K_{ok}	12	3	1	-1	-6	-12	-17	-23

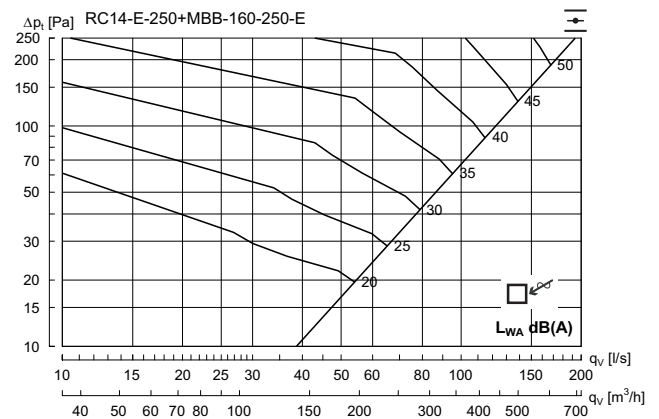

Hz	63	125	250	500	1K	2K	4K	8K
K_{ok}	15	6	0	-2	-6	-11	-16	-22

Swirl diffuser

RC14

Technical data

RC14 - 315 + MBB - Exhaust air

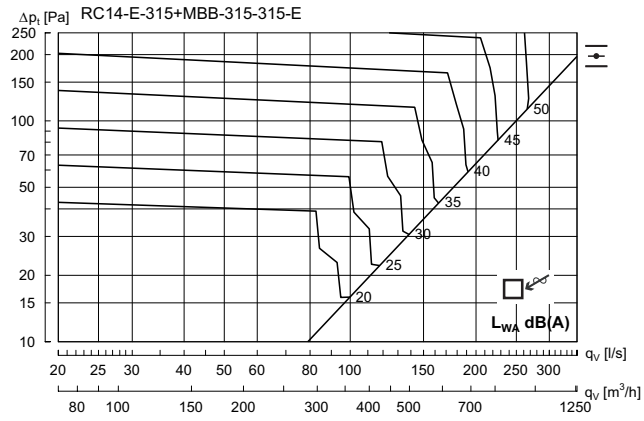

Hz	63	125	250	500	1K	2K	4K	8K
K_{ok}	10	3	1	-2	-4	-16	-24	-34

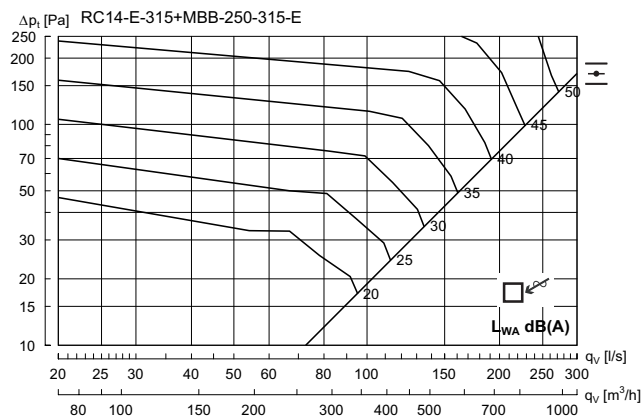

Hz	63	125	250	500	1K	2K	4K	8K
K_{ok}	9	5	1	-2	-5	-13	-18	-26

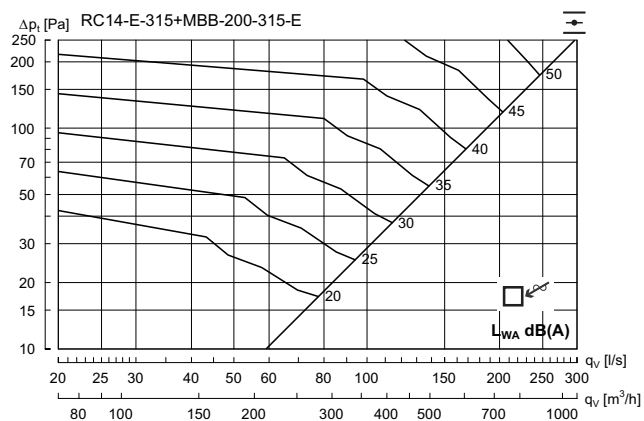

Hz	63	125	250	500	1K	2K	4K	8K
K_{ok}	14	6	1	-2	-6	-11	-16	-24



Swirl diffuser

RC15



Description

RC15 is a circular swirl diffuser with adjustable bars. The diffuser can be used for both supply and exhaust air. The swirl pattern ensures high induction and a large dynamic range, and is therefore ideal for the horizontal supply of very cold air. The diffuser can also be set to a vertical supply air pattern, enabling supply of heated air. Installing this diffuser in a plenum box type MBB can help to achieve a stable flow of air to the diffuser as well as realise the potential for individual adjustment.

- Large dynamic range
- High induction
- Suitable for cooling at very low temperatures
- Horizontal or vertical supply air pattern
- Can be used for both supply air and exhaust

Maintenance

The face plate and swirl insert can be removed to enable cleaning of internal parts or to gain access to the duct or box. The visible parts of the diffuser can be wiped with a damp cloth.

Order code

Product	RC15	a	bbb
Type			
RC15			
Functional use			
S = Supply air			
E = Exhaust Without bars			
Connection dim.			
Ød 160-315			

Example: RC15-S-160

Dimensions

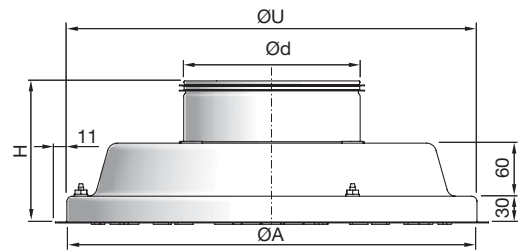

RC15 Ød mm	ØA mm	H mm	ØU* mm	Weight kg
160	360	140	370	5.30
200	360	140	370	5.40
250	460	140	470	7.40
315	540	140	550	8.10

* ØU = ceiling grid opening

Ød 315, No mounting holes for MBB !

Bar settings

Horizontal

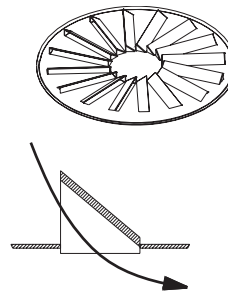

Vertical

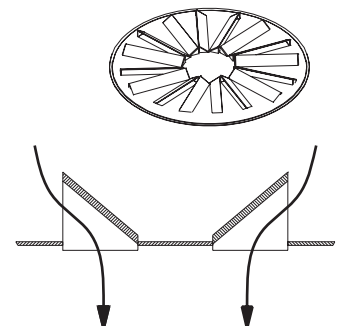

RC15-S



RC15-E

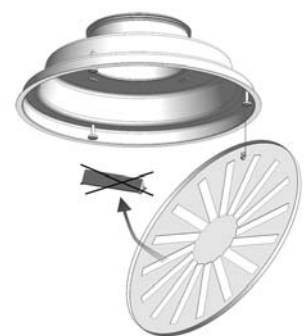

Materials and finish

Material:	Galvanised steel
Standard finish:	Powder-coated
Standard colour:	RAL 9010 Gloss 30
Bars (Only RC15-S):	Black ABS plastic

The diffuser is available in other colours. Please contact Lindab's sales department for further information.

Swirl diffuser

RC15

Accessories

Mounting brackets

DCZ

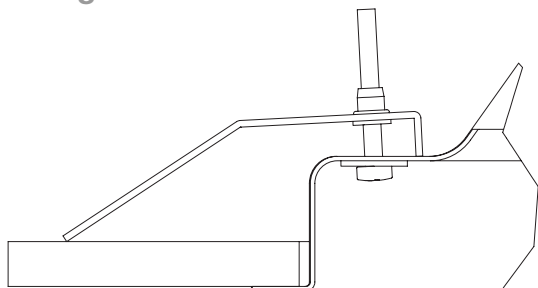

Plenum box

MBB



Extension piece

MBZ

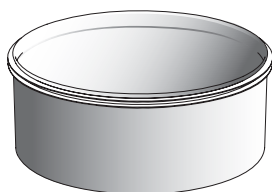

RC15 + MBB

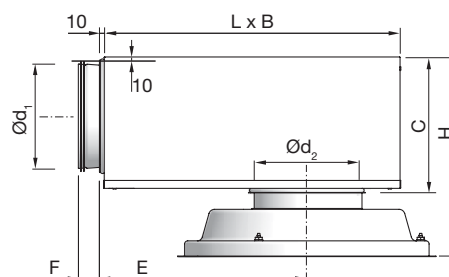

Order code - accessories

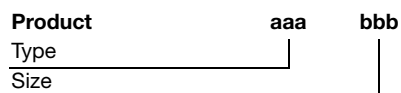

Example: DCZ-160

RC15 + MBB		B	C	E	F	H*	L
duct	RC15	mm	mm	mm	mm	mm	mm
Ød ₁ mm	Ød ₂ mm						
100	160	260	159	216	50	250 - 290	310
125	160	310	184	262	50	275 - 315	376
125	200	310	184	262	50	275 - 315	376
160	160	380	220	323	50	309 - 349	459
160	200	380	220	323	50	309 - 349	459
160	250	380	220	323	50	309 - 349	459
200	200	460	259	396	70	350 - 390	565
200	250	460	259	396	70	350 - 390	565
200	315	460	259	396	70	350 - 390	565
250	250	540	309	486	70	400 - 440	698
250	315	540	309	486	70	400 - 440	698
315	315	540	373	646	70	465 - 505	858

* Using accessory MBZ the H dimension will increase:

Ød₂ = 160 - 200 mm => H +40 mm

Ød₂ = 250 - 315 mm => H +60 mm

Module plate

LM



Order code - module plate

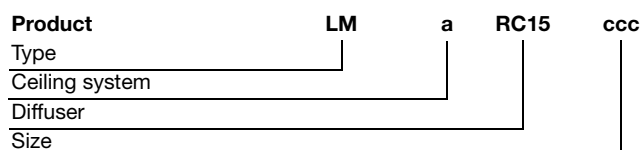

Example: LM-1-RC15-160

Ceiling system - see introductory summary

Order code

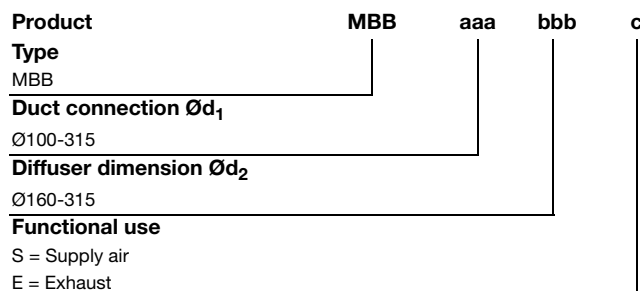

Example: RC15-S-160-MBB-125-160-S

Swirl diffuser

RC15

Technical data

Capacity

Air flow q_v [l/s] and [m³/h], total pressure Δp_t [Pa], throw $l_{0.2}$ [m] and sound power level L_{WA} [dB(A)] can be seen in the diagrams.

Frequency-related sound effect level

The sound effect level in the frequency band is defined as $L_{WA}+K_{ok}$. K_{ok} values are specified in charts beneath the diagrams on the following pages.

Quick selection, supply air

RC15 + MBB		$\Delta p_t \geq 50$ Pa		$\Delta p_t \geq 50$ Pa	
duct	RC15	30 dB(A)		35 dB(A)	
$\varnothing d_1$	$\varnothing d_2$	l/s	m ³ /h	l/s	m ³ /h
100	160	36	130	44	158
125	160	44	158	54	194
125	200	49	176	59	212
160	160	47	169	56	202
160	200	54	194	64	230
160	250	69	248	90	324
200	200	56	202	66	238
200	250	82	295	99	356
200	315	101	364	125	450
250	250	90	324	106	382
250	315	113	407	137	493
315	315	138	497	163	587

Throw $l_{0.2}$

Throw $l_{0.2}$ [m] is specified at a terminal velocity of 0.2 m/s.

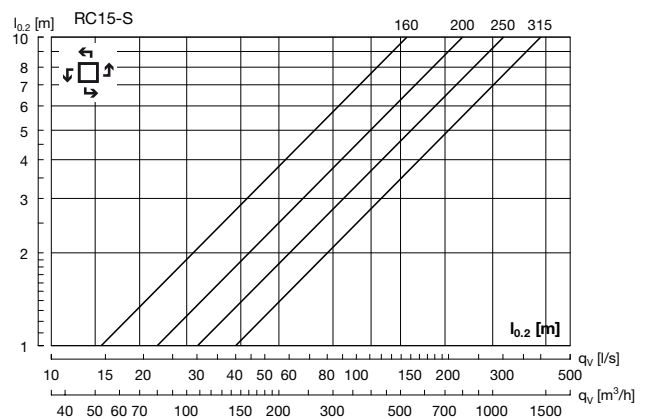
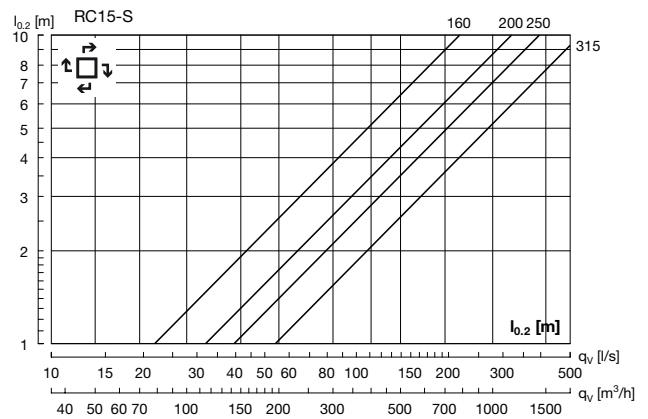

Sound attenuation

Sound attenuation of the diffusers ΔL from duct to room, including end reflection - see table below.

RC15 + MBB		Centre frequency Hz							
duct	RC15	63	125	250	500	1K	2K	4K	8K
$\varnothing d_1$	$\varnothing d_2$								
100	160	17	15	5	12	19	20	20	21
125	160	16	14	8	18	18	20	20	21
125	200	11	12	6	14	14	19	18	19
160	160	16	15	11	22	20	22	21	21
160	200	16	15	9	22	19	21	20	21
160	250	18	14	4	17	14	16	18	19
200	200	13	12	8	17	20	19	21	18
200	250	12	9	6	14	19	16	18	17
200	315	11	8	4	10	17	16	19	17
250	250	13	8	7	15	19	19	18	18
250	315	12	8	6	14	17	17	18	18
315	315	8	9	9	14	18	18	18	23

Balancing

Balancing data is contained in a separate brochure.

Swirl diffuser

RC15

Technical data

Throws/Turning points

Throw $l_{0,2}$ [m] is specified at a terminal velocity of 0.2 m/s.
Turning point $l_{0,0}$ [m] is specified for +5 K and +10 K respectively.

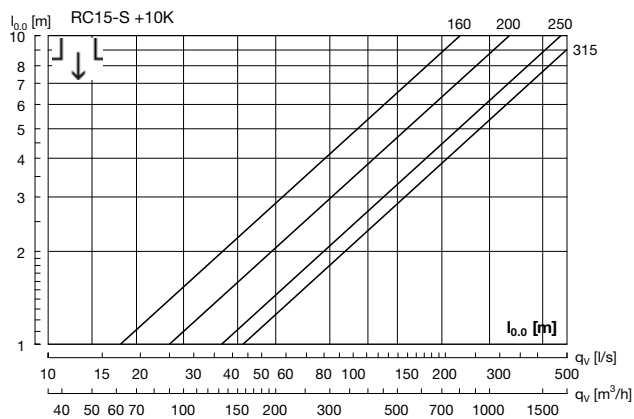
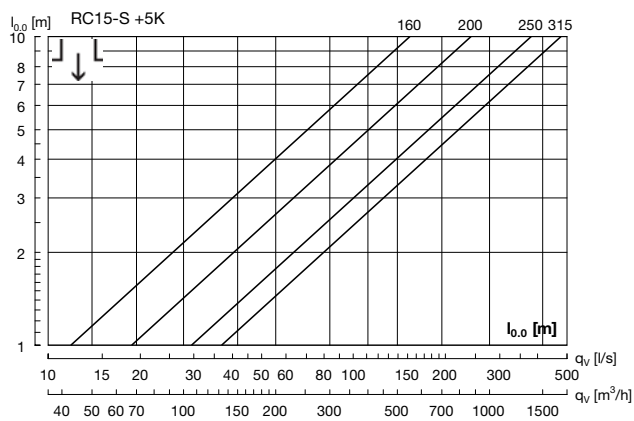
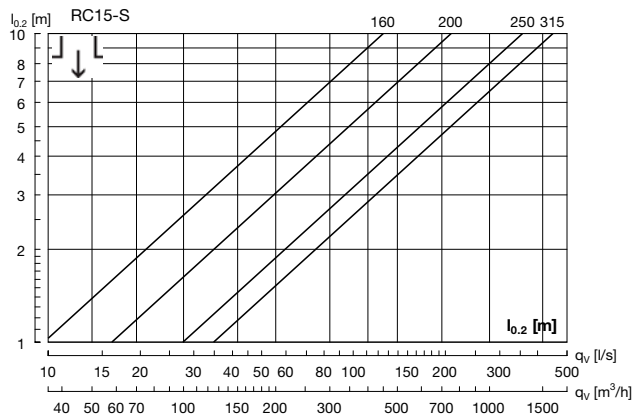

RC15 without box – supply air

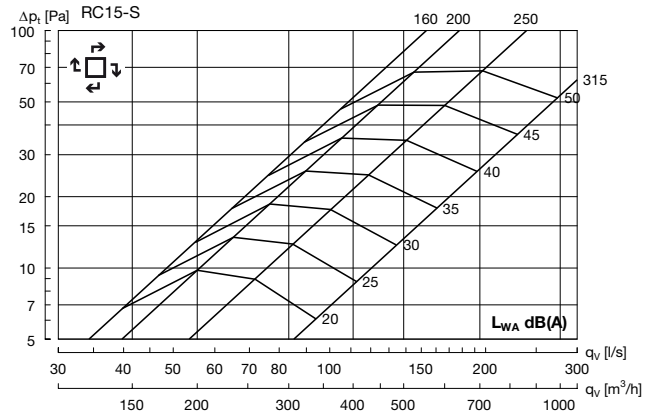

Swirl diffuser

RC15

Technical data

RC15 160 + MBB - Supply air

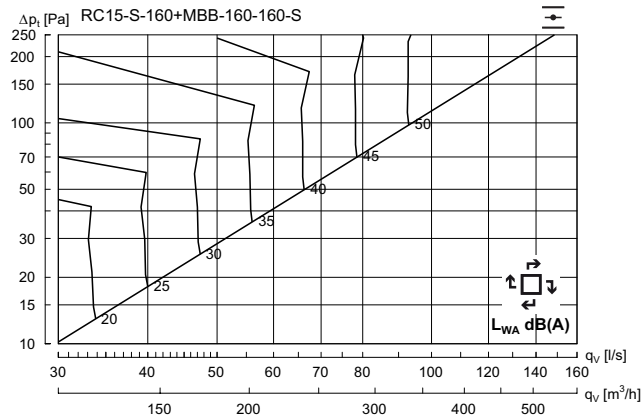

Hz	63	125	250	500	1K	2K	4K	8K
K_{ok}	10	2	-4	0	-5	-17	-23	-31

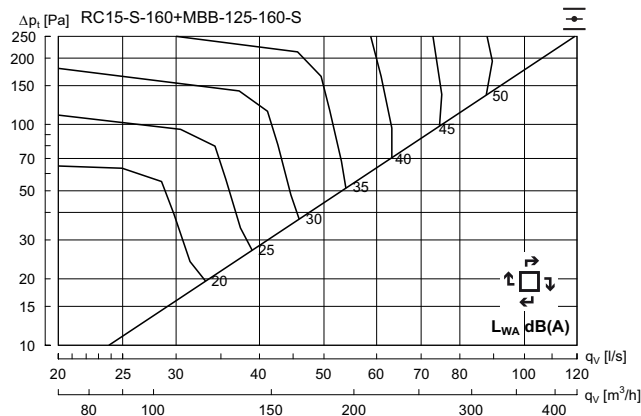

Hz	63	125	250	500	1K	2K	4K	8K
K_{ok}	10	4	-1	0	-6	-13	-18	-24

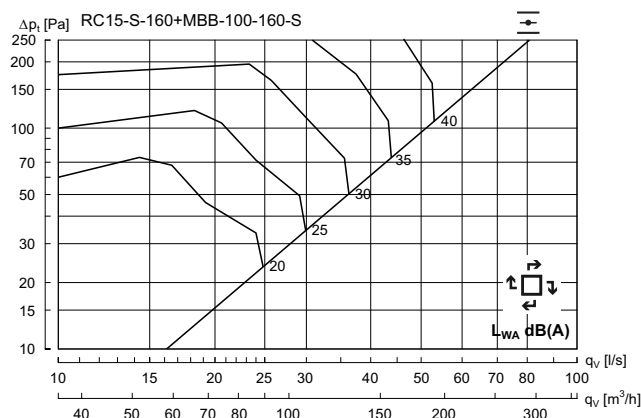

Hz	63	125	250	500	1K	2K	4K	8K
K_{ok}	12	4	2	-1	-8	-12	-16	-19

RC15 - 200 + MBB - Supply air

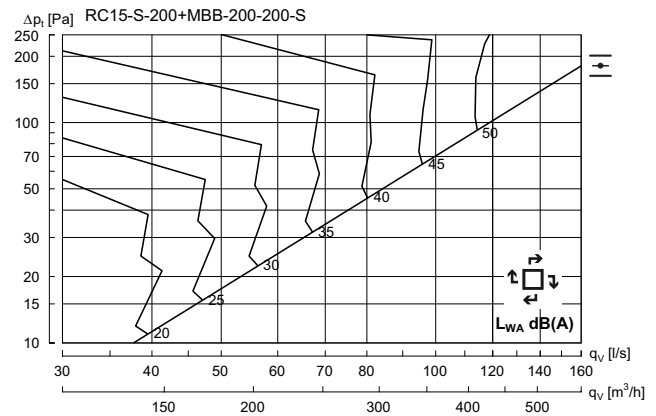

Hz	63	125	250	500	1K	2K	4K	8K
K_{ok}	8	3	-4	-1	-4	-15	-22	-31

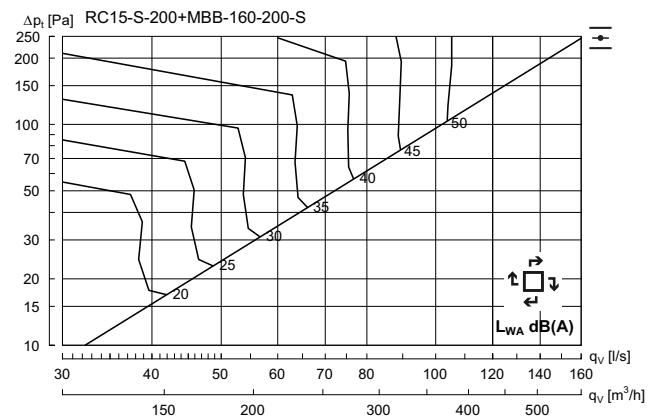

Hz	63	125	250	500	1K	2K	4K	8K
K_{ok}	9	3	-1	-2	-4	-14	-21	-29

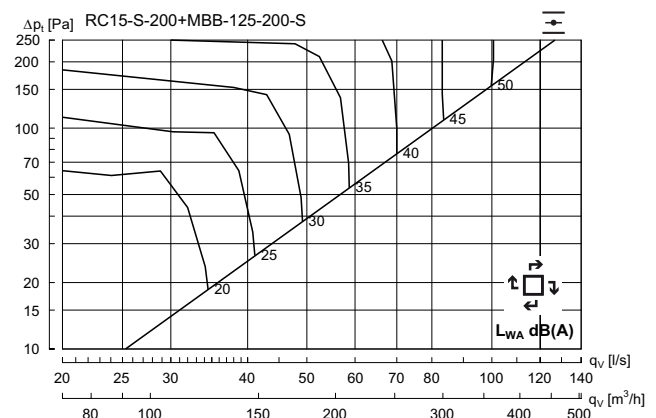

Hz	63	125	250	500	1K	2K	4K	8K
K_{ok}	7	5	0	-1	-5	-13	-17	-24

Swirl diffuser

RC15

Technical data

RC15 - 250 + MBB - Supply air

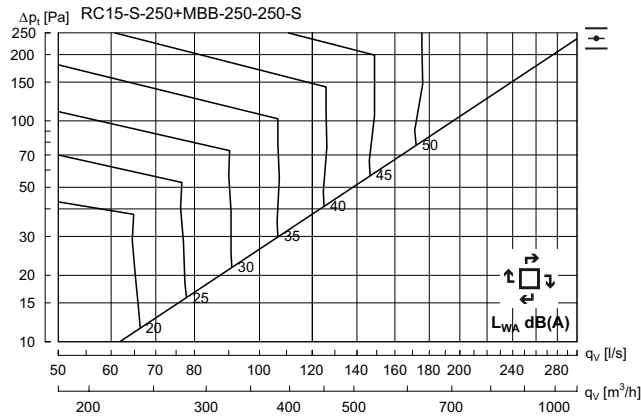

Hz	63	125	250	500	1K	2K	4K	8K
K_{ok}	12	1	-4	0	-4	-16	-24	-20

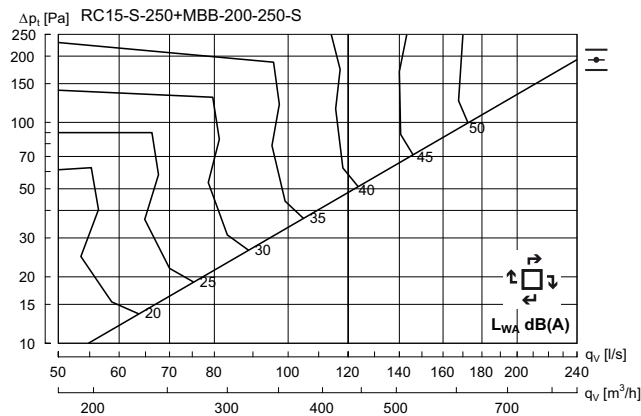

Hz	63	125	250	500	1K	2K	4K	8K
K_{ok}	10	4	-3	-2	-3	-15	-21	-29

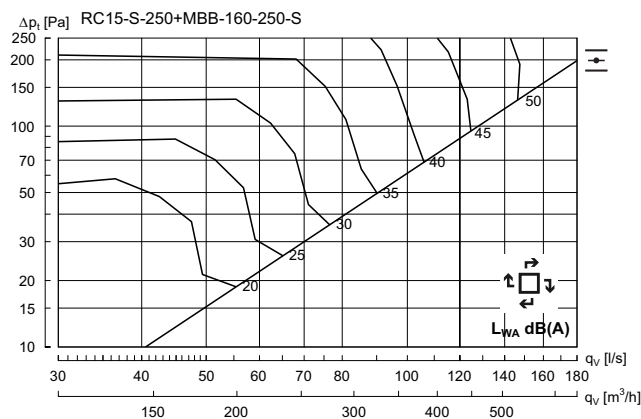

Hz	63	125	250	500	1K	2K	4K	8K
K_{ok}	15	5	0	-3	-4	-13	-19	-25

RC15 - 315 + MBB - Supply air

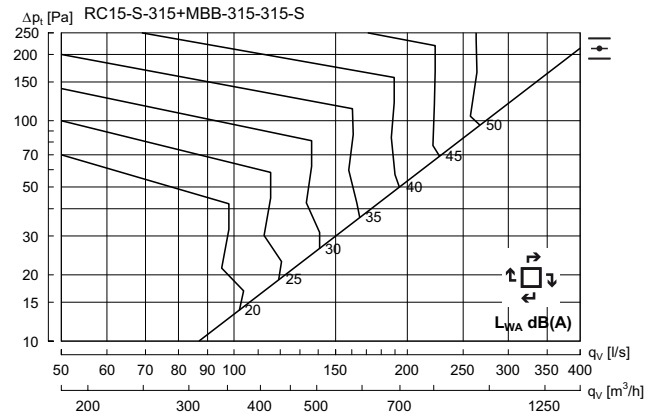

Hz	63	125	250	500	1K	2K	4K	8K
K_{ok}	14	3	-2	-2	-4	-13	-22	-31

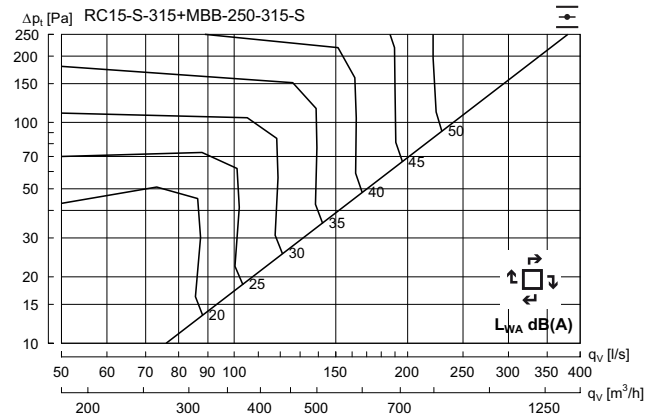

Hz	63	125	250	500	1K	2K	4K	8K
K_{ok}	11	3	-2	-1	-4	-13	-19	-28

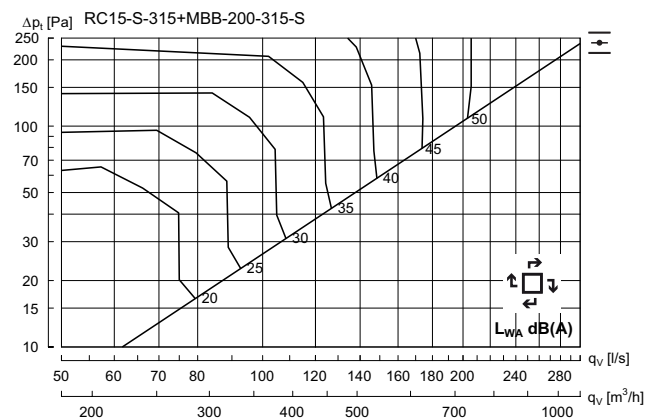

Hz	63	125	250	500	1K	2K	4K	8K
K_{ok}	9	7	-1	-2	-5	-13	-19	-26

Swirl diffuser

RC15

Technical data

RC15 without box – Exhaust air

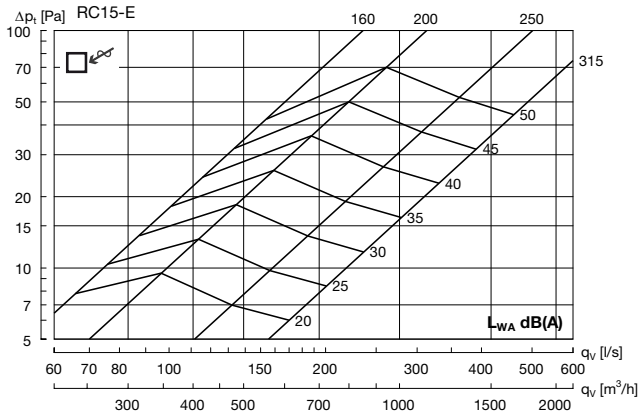

RC15 160 + MBB - Exhaust air

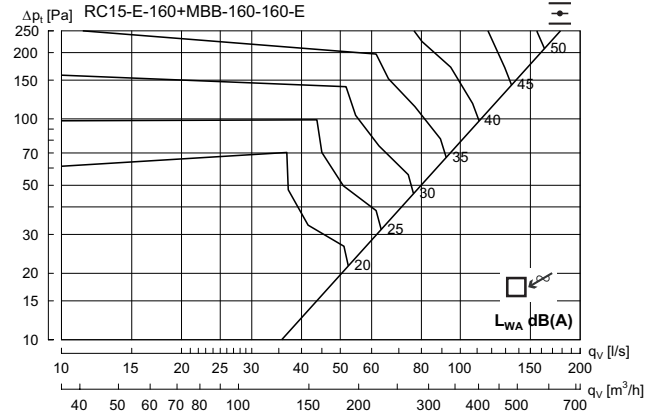

Hz	63	125	250	500	1K	2K	4K	8K
K_{ok}	16	6	0	-3	-6	-11	-16	-21

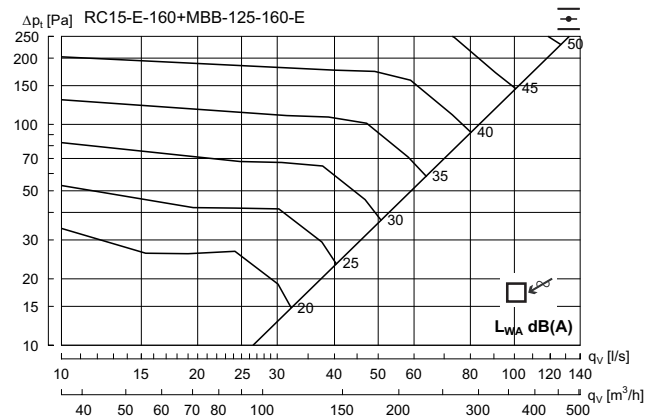

Hz	63	125	250	500	1K	2K	4K	8K
K_{ok}	13	6	1	-2	-7	-12	-14	-22

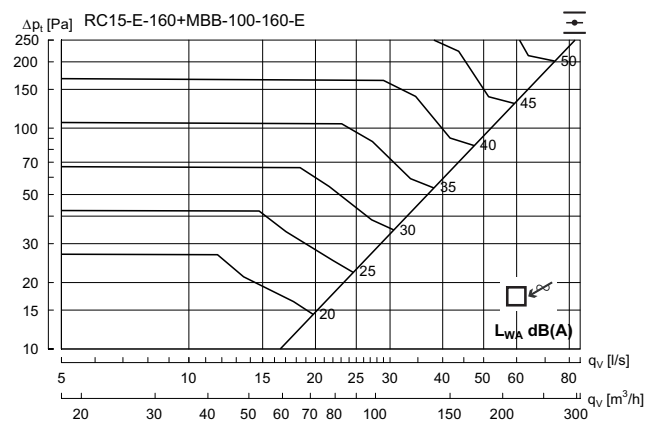

Hz	63	125	250	500	1K	2K	4K	8K
K_{ok}	11	4	3	0	-9	-13	-17	-23

Swirl diffuser

RC15

Technical data

RC15 200 + MBB - Exhaust air

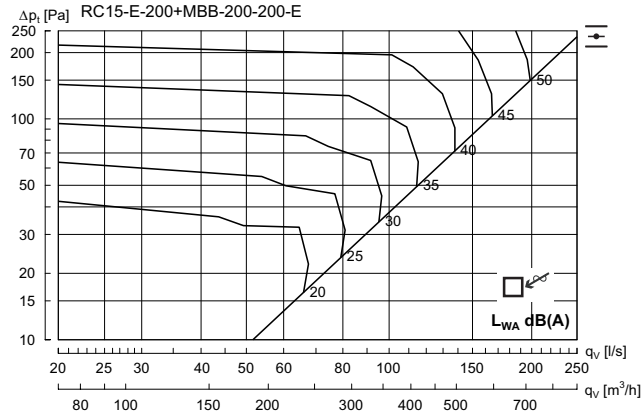

Hz	63	125	250	500	1K	2K	4K	8K
K_{ok}	14	5	0	-2	-5	-11	-16	-24

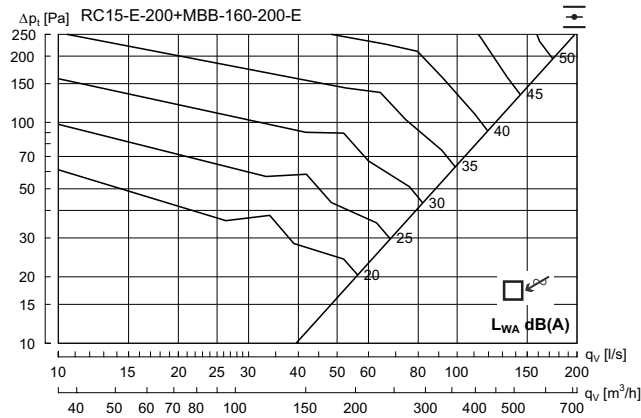

Hz	63	125	250	500	1K	2K	4K	8K
K_{ok}	17	6	-1	-3	-6	-10	-14	-19

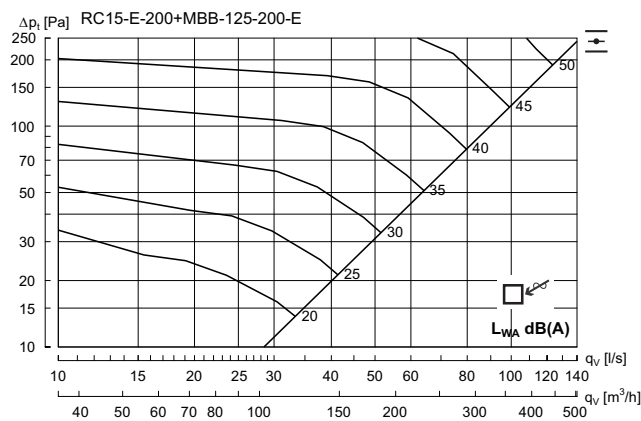

Hz	63	125	250	500	1K	2K	4K	8K
K_{ok}	14	3	1	-1	-6	-12	-15	-22

Technical data

RC15 - 250 + MBB - Exhaust air

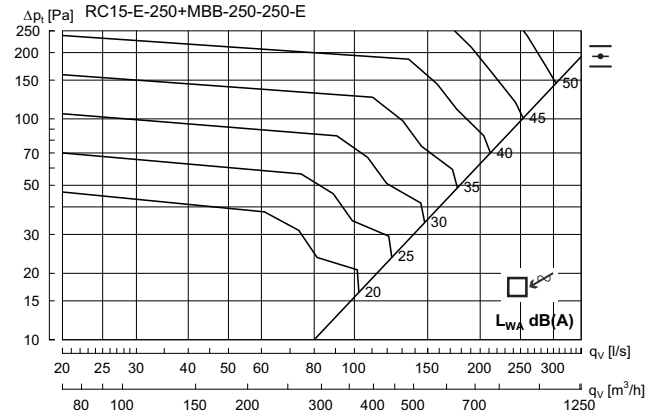

Hz	63	125	250	500	1K	2K	4K	8K
K_{ok}	12	6	2	-3	-6	-12	-17	-24

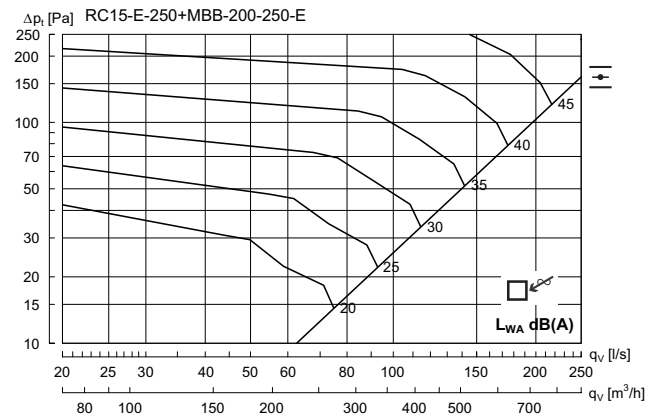

Hz	63	125	250	500	1K	2K	4K	8K
K_{ok}	13	5	0	-3	-6	-10	-14	-23

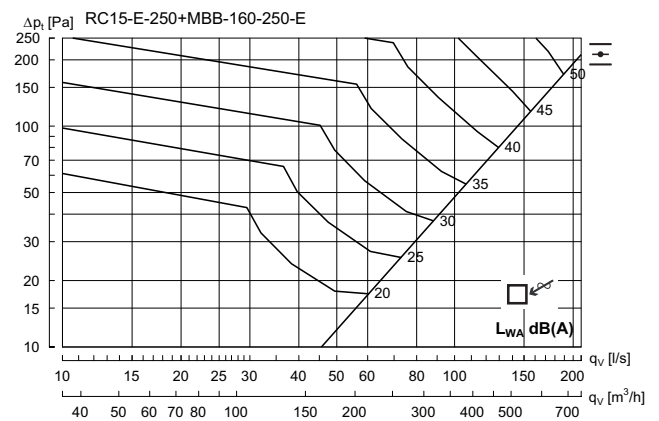

Hz	63	125	250	500	1K	2K	4K	8K
K_{ok}	13	7	0	-3	-6	-10	-15	-19

Swirl diffuser

RC15

Technical data

RC15 - 315 + MBB - Exhaust air

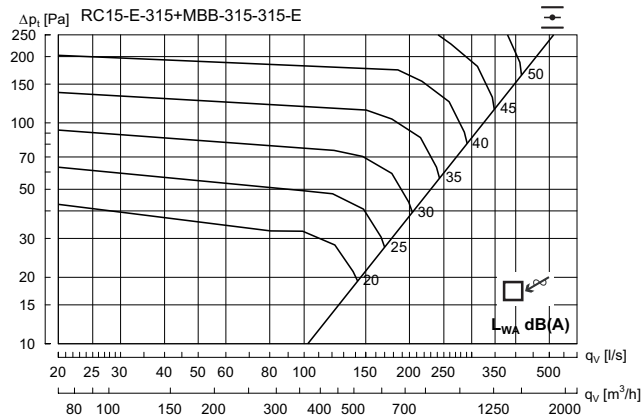

Hz	63	125	250	500	1K	2K	4K	8K
K_{ok}	12	5	3	-3	-6	-11	-16	-25

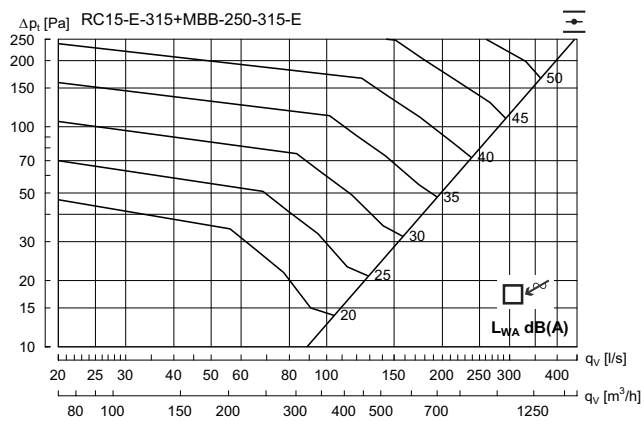

Hz	63	125	250	500	1K	2K	4K	8K
K_{ok}	9	5	2	-3	-5	-11	-17	-25

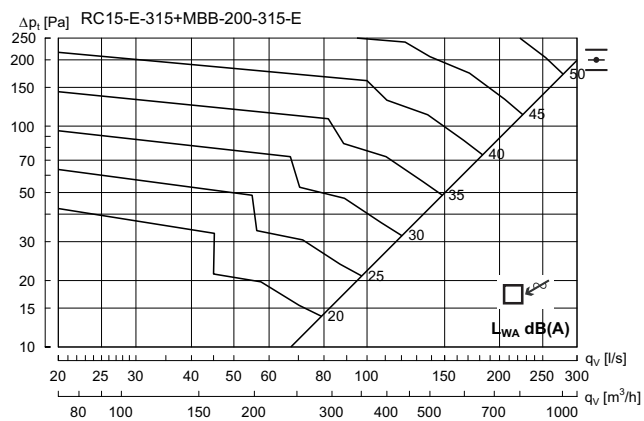

Hz	63	125	250	500	1K	2K	4K	8K
K_{ok}	15	5	1	-3	-5	-10	-15	-23

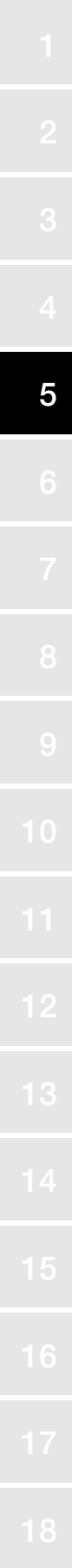

Nozzle diffuser

NC19



Description

NC19 is a circular diffuser with individually adjustable nozzles. The diffuser is suitable for the horizontal supply of cooled air, where great flexibility in the dispersal pattern is required. The diffuser can also be set to a vertical supply air pattern, enabling supply of heated air. Installing this diffuser in a plenum box type MBB can help to achieve a stable flow of air to the diffuser as well as realise the potential for individual adjustment.

- Adjustable dispersal patterns
- No pressure change for different dispersal patterns
- Suitable for horizontal or vertical supply air patterns

Maintenance

The face plate can be removed to enable cleaning of internal parts or to gain access to the duct or box. The visible parts of the diffuser can be wiped with a damp cloth.

Order code

Product	NC19	-	S	-	aaa
Type	NC19				
Functional use					
Connection dim.					

Example: NC19-S-200

Dimensions

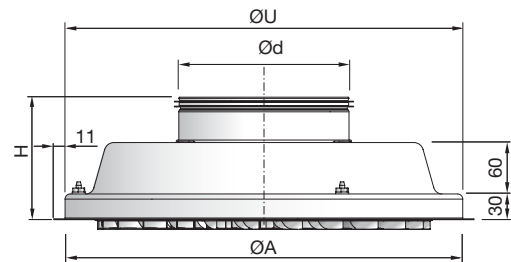

NC19 Ød	ØA	H	ØU*	Weight
mm	mm	mm	mm	kg
125	360	140	370	3.90
160	460	140	470	5.30
200	460	140	470	5.40
250	540	140	550	7.40
315	540	140	550	8.10

* ØU = ceiling grid opening

Ød 315, No mounting holes for MBB !



Materials and finish

Material: Galvanised steel
 Standard finish: Powder-coated
 Standard colour: RAL 9010, Gloss 30
 Nozzles: White ABS plastic

The diffuser is available in other colours. Please contact Lindab's sales department for further information.

Nozzle diffuser

NC19

Accessories

Mounting brackets

DCZ

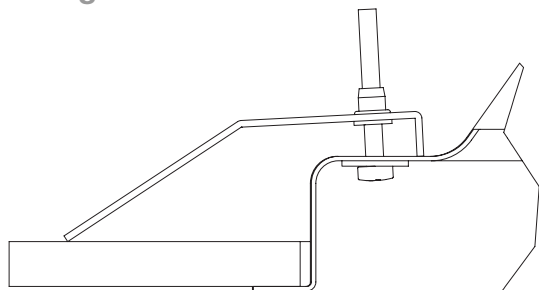

Plenum box

MBB



NC19 + MBB

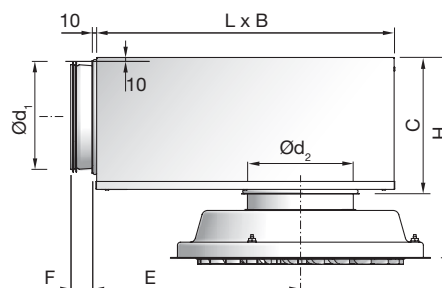

Extension piece

MBZ

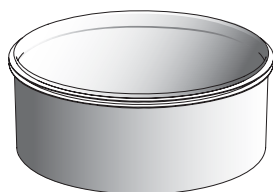

Order code - accessories

Product **aaa** **bbb**
 Type
 Size

Example: DCZ-200

Module plate

LM

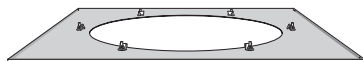

Order code - module plate

Product **LM** **a** **NC19** **ccc**
 Type
 Ceiling system
 Diffuser
 Size

Example: LM-1-NC19-200

Ceiling system - see introductory summary

NC19 + MBB		B	C	E	F	H*	L
duct	NC19	mm	mm	mm	mm	mm	mm
Ød ₁	Ød ₂						
100	125	260	159	216	50	250 - 290	310
100	160	260	159	216	50	250 - 290	310
125	125	310	184	262	50	275 - 315	376
125	160	310	184	262	50	275 - 315	376
125	200	310	184	262	50	275 - 315	376
160	160	380	220	323	50	309 - 349	459
160	200	380	220	323	50	309 - 349	459
160	250	380	220	323	50	309 - 349	459
200	200	460	259	396	70	350 - 390	565
200	250	460	259	396	70	350 - 390	565
200	315	460	259	396	70	350 - 390	565
250	250	540	309	486	70	400 - 440	698
250	315	540	309	486	70	400 - 440	698
315	315	540	373	646	70	465 - 505	858

* Using accessory MBZ the H dimension will increase:
 Ød₂ = 125 - 200 mm => H +40 mm
 Ød₂ = 250 - 315 mm => H +60 mm

Order code

Product **MBB** - **aaa** - **bbb** - **S**
 Type
 MBB
 Duct connection Ød₁
 Ø100-315
 Diffuser dimension Ød₂
 Ø125-315
 Functional use
 S = Supply air

Example: NC19-S-200-MBB-200-200-S

Nozzle diffuser

NC19

Technical data

Capacity

Air flow q_v [l/s] and [m³/h], total pressure Δp_t [Pa], throw $l_{0.2}$ [m] and sound power level L_{WA} [dB(A)] can be seen in the diagrams.

Frequency-related sound effect level

The sound effect level in the frequency band is defined as $L_{WA} + K_{ok}$. K_{ok} values are specified in chart beneath the diagrams on the following pages.

Quick selection, supply air

NC19 + MBB		$\Delta p_t \geq 50$ Pa		$\Delta p_t \geq 50$ Pa	
duct	NC19	30 dB(A)		35 dB(A)	
$\varnothing d_1$	$\varnothing d_2$	l/s	m ³ /h	l/s	m ³ /h
100	125	25	90	33	119
100	160	39	140	47	169
125	125	35	126	41	148
125	160	48	173	59	212
125	200	54	194	64	230
160	160	52	187	63	227
160	200	59	212	72	259
160	250	76	274	96	346
200	200	66	238	80	288
200	250	92	331	112	403
200	315	97	349	120	432
250	250	100	360	119	428
250	315	109	392	131	472
315	315	121	436	143	515



Throw $l_{0.2}$

Throw $l_{0.2}$ [m] is specified at a terminal velocity of 0.2 m/s.

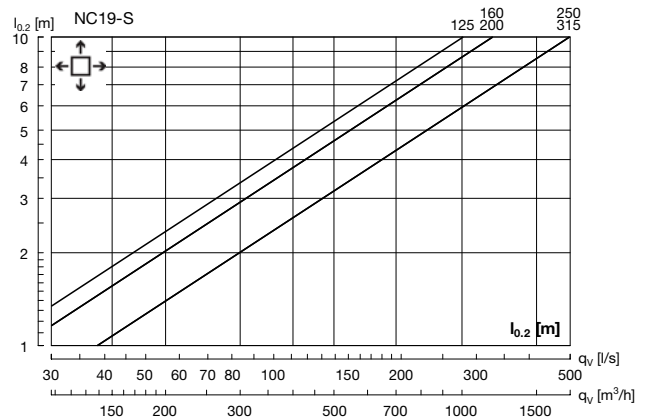
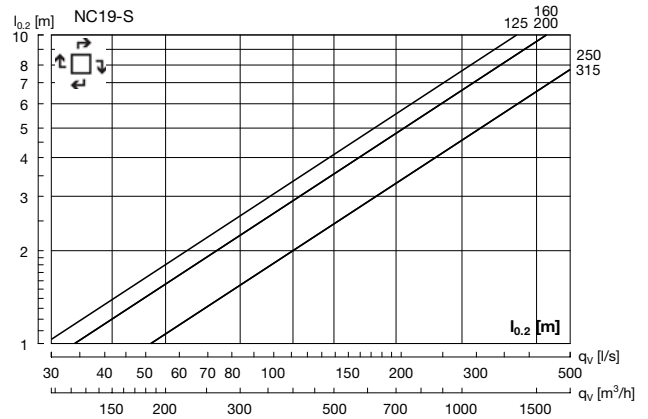

Sound attenuation

Sound attenuation of the diffusers ΔL from duct to room, including end reflection, see table below

NC19 + MBB		Centre frequency Hz							
duct	NC19	63	125	250	500	1K	2K	4K	8K
$\varnothing d_1$	$\varnothing d_2$								
100	125	20	16	6	15	20	20	19	23
100	160	16	16	4	13	18	19	17	21
125	125	17	15	10	19	20	20	19	22
125	160	15	14	7	18	18	18	18	21
125	200	13	12	5	15	15	16	17	19
160	160	16	15	11	22	20	20	20	20
160	200	16	15	8	21	19	19	19	21
160	250	16	14	5	17	14	16	18	19
200	200	15	10	8	16	20	18	20	18
200	250	13	9	5	13	17	15	19	17
200	315	13	9	4	11	16	15	17	17
250	250	14	8	8	16	18	18	18	19
250	315	14	8	6	14	17	16	17	18
315	315	8	10	9	14	17	17	18	24

Balancing

Balancing data is contained in a separate brochure.

Nozzle diffuser

NC19

Technical data

Throws/Turning points

Throw $l_{0,2}$ [m] is specified at a terminal velocity of 0.2 m/s.
Turning point $l_{0,0}$ [m] is specified for +5 K and +10 K respectively.

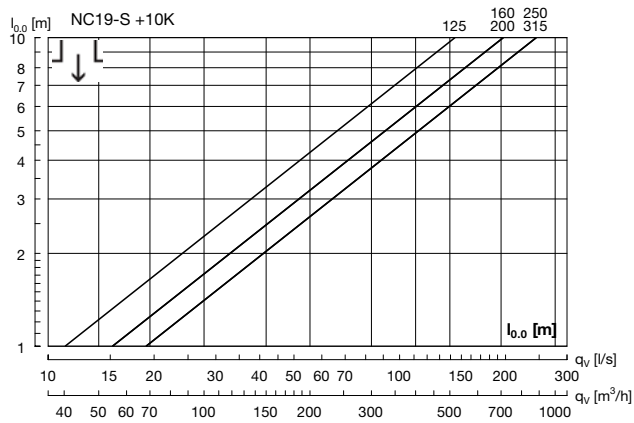
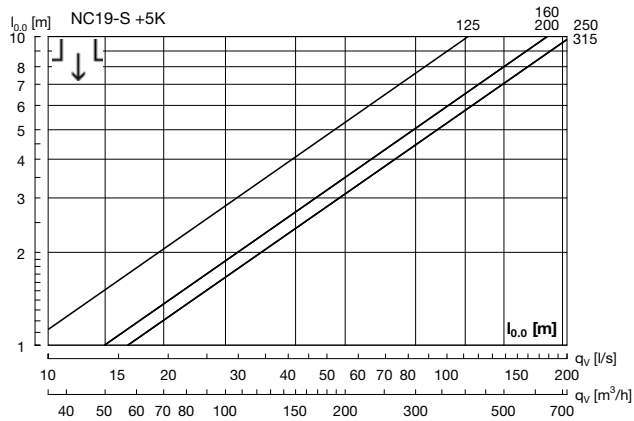
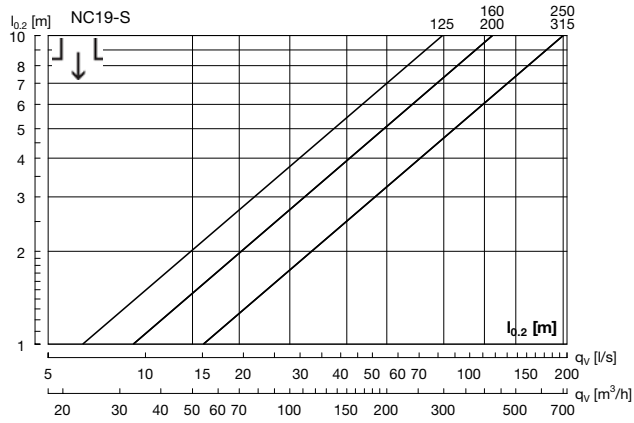

NC19 without box – Supply air

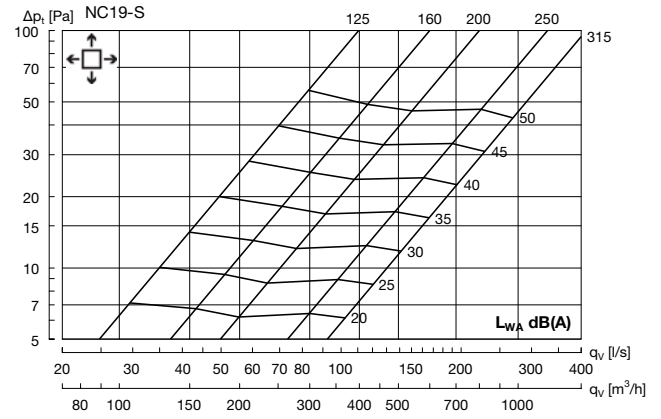

Nozzle diffuser

NC19

Technical data

NC19 - 125 + MBB - Supply air

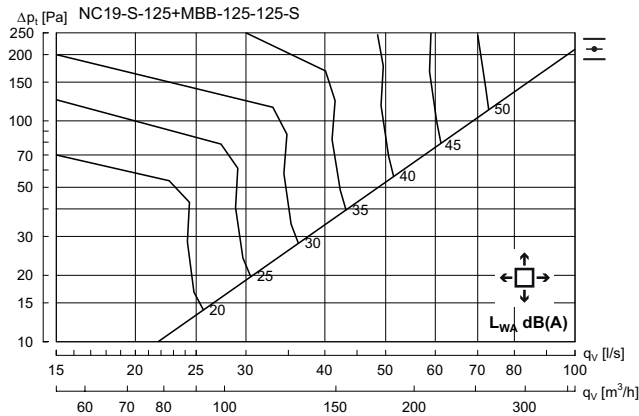

Hz	63	125	250	500	1K	2K	4K	8K
K_{ok}	11	1	-4	0	-5	-15	-23	-35

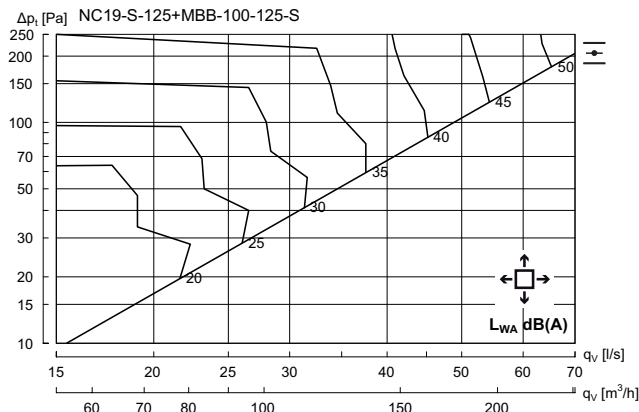

Hz	63	125	250	500	1K	2K	4K	8K
K_{ok}	10	3	2	0	-7	-15	-22	-27

NC19 - 160 + MBB - Supply air

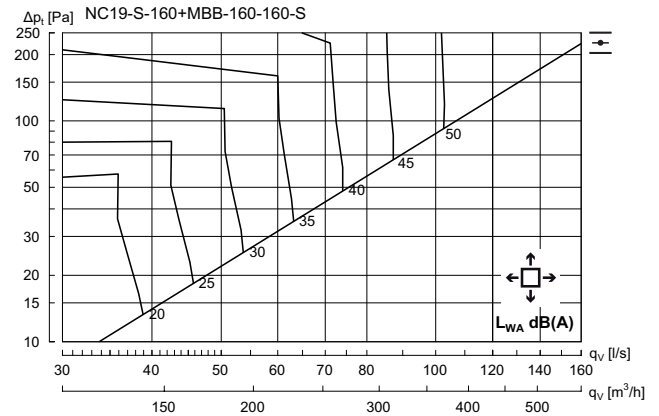

Hz	63	125	250	500	1K	2K	4K	8K
K_{ok}	6	5	-3	-1	-4	-14	-21	-32

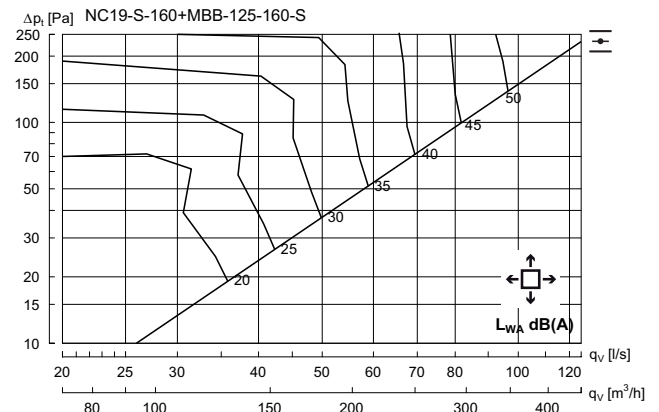

Hz	63	125	250	500	1K	2K	4K	8K
K_{ok}	8	5	-1	-1	-6	-13	-17	-25

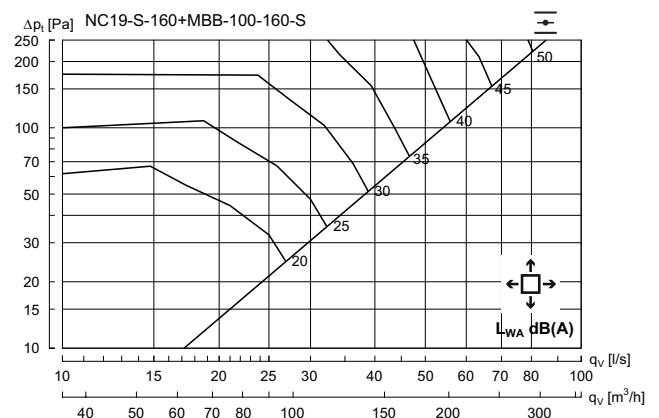

Hz	63	125	250	500	1K	2K	4K	8K
K_{ok}	10	4	1	0	-8	-12	-16	-21

Nozzle diffuser

NC19

Technical data

NC19 - 200 + MBB - Supply air

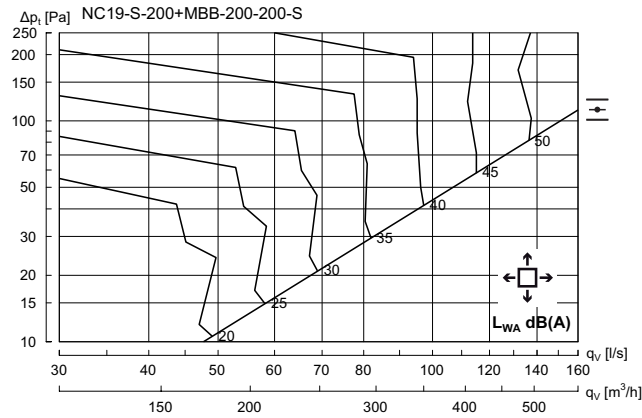

Hz	63	125	250	500	1K	2K	4K	8K
K_{ok}	11	2	-5	0	-4	-16	-23	-33

NC19 - 250 + MBB - Supply air

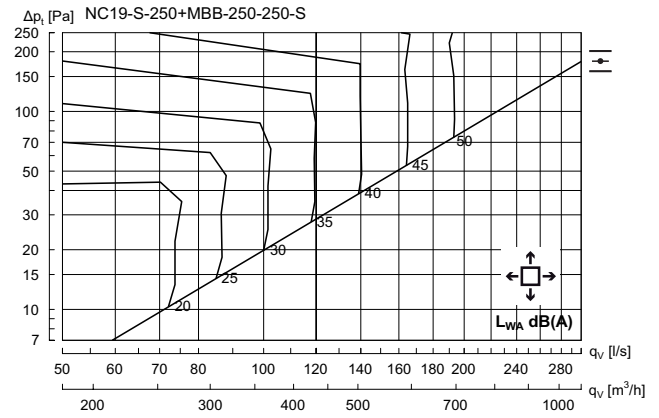

Hz	63	125	250	500	1K	2K	4K	8K
K_{ok}	10	3	-4	-1	-4	-15	-23	-34

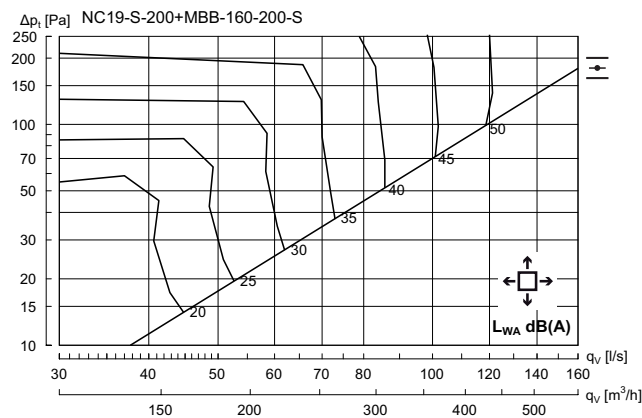

Hz	63	125	250	500	1K	2K	4K	8K
K_{ok}	9	4	-2	-1	-5	-14	-20	-28

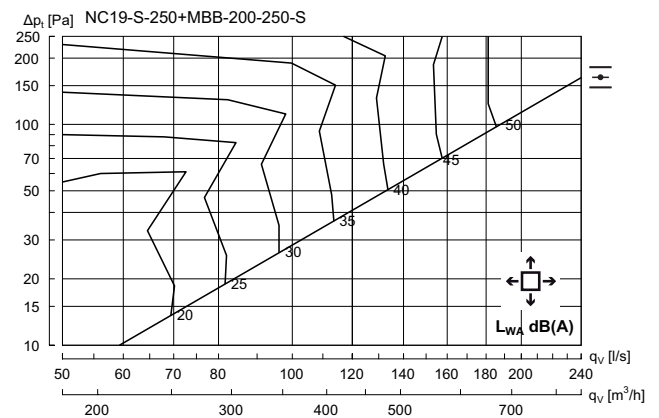

Hz	63	125	250	500	1K	2K	4K	8K
K_{ok}	6	7	-2	-1	-4	-14	-20	-29

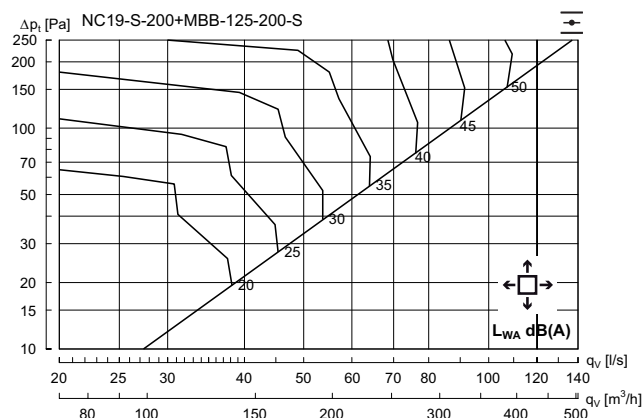

Hz	63	125	250	500	1K	2K	4K	8K
K_{ok}	6	5	0	0	-6	-12	-17	-25

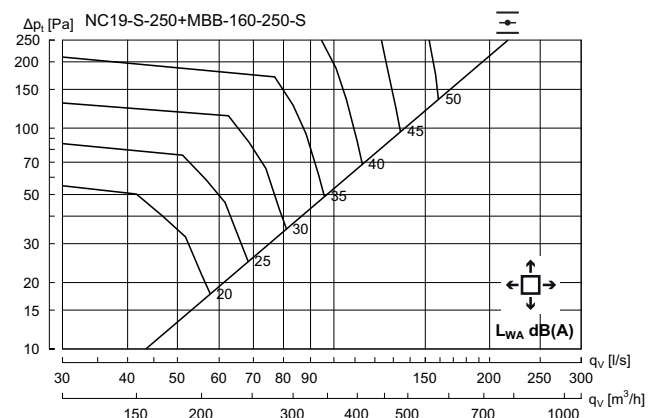

Hz	63	125	250	500	1K	2K	4K	8K
K_{ok}	11	6	1	-2	-5	-12	-18	-26

Nozzle diffuser

NC19

Technical data

NC19 - 315 + MBB - Supply air

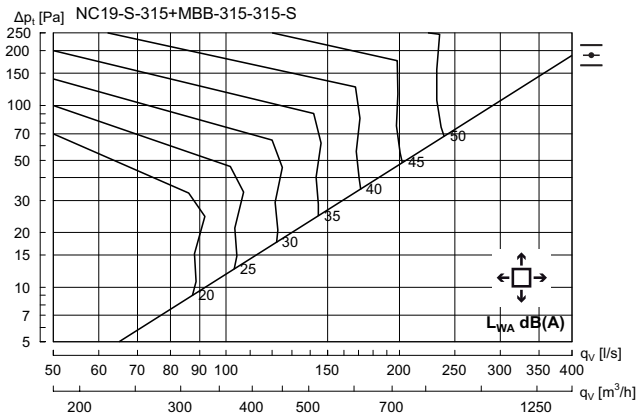

Hz	63	125	250	500	1K	2K	4K	8K
K_{ok}	9	1	-4	-1	-3	-17	-26	-40

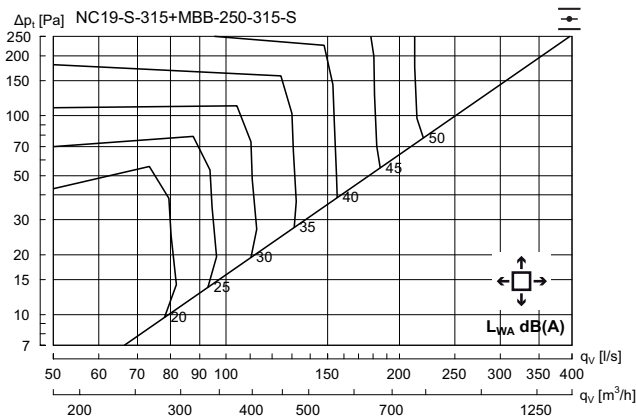

Hz	63	125	250	500	1K	2K	4K	8K
K_{ok}	9	4	-2	-1	-4	-15	-23	-30

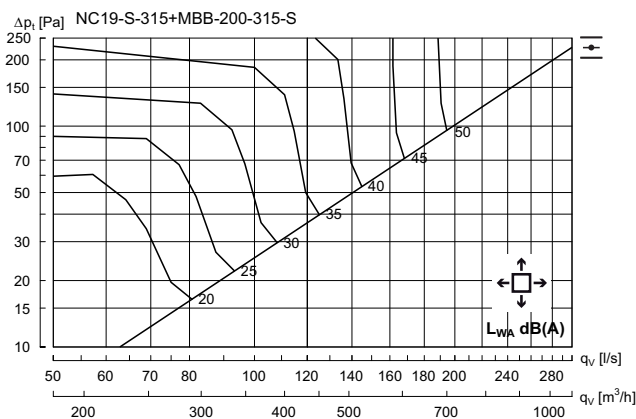

Hz	63	125	250	500	1K	2K	4K	8K
K_{ok}	8	7	0	-2	-5	-14	-20	-30



Swirl diffuser

RCG



Dimensions

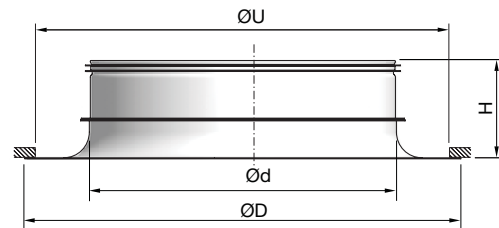

RCG Ød	ØD	H	ØU	Free area A	Weight
mm	mm	mm	mm	m ²	kg
125	200	70	150	0,0031	0,40
160	250	70	200	0,0072	0,50
200	300	70	250	0,0106	0,60
250	350	90	300	0,0189	0,80
315	450	100	400	0,027	1,00
400	570	150	500	0.039	1,50

* ØU = Cutting dimension

Description

RCG is a circular swirl diffuser with fixed bars. RCG is suitable for the horizontal supply of very cold air. The swirl pattern ensures optimum distribution and high induction, as well as a large dynamic range. Installing a RCG diffuser in a plenum box type MBB can help to achieve a stable flow of air to the diffuser as well as realise the potential for individual adjustment. RCG can also be installed directly in the duct using the traverse bracket GRZ1, which is available as an accessory.

- Large dynamic range
- High induction
- Suitable for cooling at very low temperatures

Maintenance

Diffusers are removed to enable cleaning of the plenum box or duct system. The visible parts of the diffuser can be wiped with a damp cloth.

Order code

Product	RCG	aaa
Type	RCG	
Connection dim.	Ød 125-400	

Example: RCG-315

Materials and finish

Material: Steel
 Standard finish: Powder-coated
 Standard colour: RAL 9010 Gloss 30

The diffuser is available in other colours. Please contact Lindab's sales department for further information.



Swirl diffuser

RCG

Accessories

1 **1** Traverse bracket

GRZ1



2 **2** Extension piece

MBZ

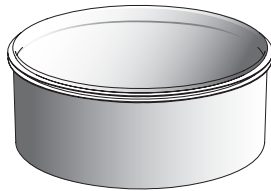

Order code - accessoires

Product	aaa	bbb
Type		
Size		

Example: GRZ1-315

3 **3** Module plate

LM

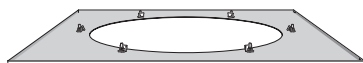

Order code - module plate

Product	LM	a	RCG	ccc
Type				
Ceiling system				
Diffuser				
Size				

Example: LM-1-RCG-315

Ceiling system - see introductory summary

Dimensions

4 **4** Plenum box

MBB

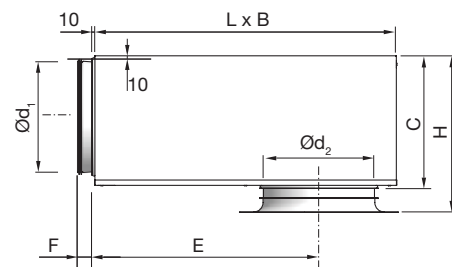

RCG + MBB

RCG + MBB		B	C	E	F	H*	L
duct	RCG	mm	mm	mm	mm	mm	mm
Ød ₁ mm	Ød ₂ mm						
100	125	260	159	216	50	185 - 215	310
100	160	260	159	216	50	185 - 215	310
125	125	310	184	262	50	210 - 240	376
125	160	310	184	262	50	210 - 240	376
125	200	310	184	262	50	210 - 240	376
160	160	380	220	323	50	244 - 274	459
160	200	380	220	323	50	244 - 274	459
160	250	380	220	323	50	264 - 304	459
200	200	460	259	396	70	305 - 345	565
200	250	460	259	396	70	325 - 365	565
200	315	460	259	396	70	325 - 365	565
250	250	540	309	486	70	360 - 400	698
250	315	540	309	486	70	360 - 400	698
250	400	540	309	486	70	410 - 450	698
315	315	540	373	646	70	425 - 465	858
315	400	540	373	646	70	475 - 515	858

* Using accessory MBZ the H dimension will increase:

Ød₂ = 125 - 200 mm => H +40 mm

Ød₂ = 250 - 315 mm => H +60 mm

Ød₂ = 400 mm => H +80 mm

Order code

Product	MBB	aaa	bbb	S
Type				
MBB				
Duct connection Ød ₁				
Ø100-315				
Diffuser dimension Ød ₂				
Ø125-400				
Functional use				
S = Supply air				

Example: RCG-315-MBB-315-315-S

Swirl diffuser

RCG

Technical data

Capacity

Air flow q_v [l/s] and [m³/h], total pressure Δp_t [Pa], throw $l_{0.2}$ [m] and sound power level L_{WA} [dB(A)] can be seen in the diagrams.

Frequency-related sound effect level

The sound effect level in the frequency band is defined as $L_{WA} + K_{ok}$. K_{ok} values are specified in charts beneath the diagrams on the following pages.

Quick selection, supply air

RCG + MBB		$\Delta p_t \geq 50$ Pa		$\Delta p_t \geq 50$ Pa	
duct	RCG	30 dB(A)		35 dB(A)	
$\varnothing d_1$	$\varnothing d_2$	l/s	m ³ /h	l/s	m ³ /h
100	125	17	61	20	72
100	160	28	101	33	119
125	125	20	72	24	86
125	160	32	115	39	140
125	200	42	151	52	187
160	160	34	122	41	148
160	200	48	173	59	212
160	250	60	216	76	274
200	200	50	180	63	227
200	250	67	241	84	302
200	315	90	324	111	400
250	250	76	274	93	335
250	315	99	356	122	439
250	400	109	392	143	515
315	315	119	428	142	511
315	400	142	511	177	637

Throw $l_{0.2}$

Throw $l_{0.2}$ [m] is specified at a terminal velocity of 0.2 m/s.

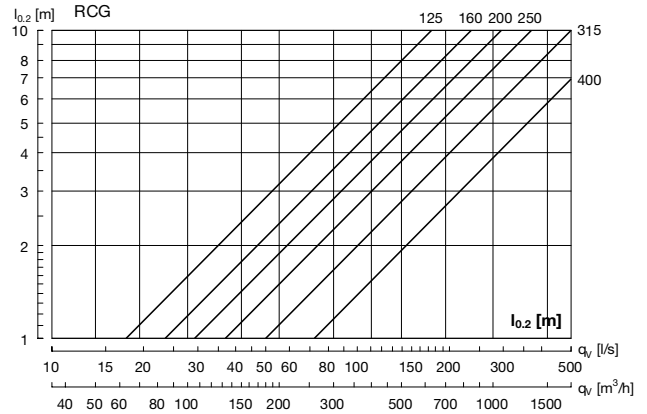

Sound attenuation

Sound attenuation of the diffusers ΔL from duct to room, including end reflection - see table below.

RCG + MBB		Centre frequency Hz							
duct	RCG	63	125	250	500	1K	2K	4K	8K
$\varnothing d_1$	$\varnothing d_2$								
100	125	20	16	7	18	19	18	17	21
100	160	19	16	5	17	17	16	16	19
125	125	17	15	9	21	17	19	18	20
125	160	13	14	8	20	14	16	16	20
125	200	13	12	5	17	13	14	15	18
160	160	18	15	9	22	18	17	19	20
160	200	17	15	8	21	17	16	18	19
160	250	16	15	4	17	14	14	16	18
200	200	14	9	8	18	18	15	18	17
200	250	13	10	5	15	17	14	17	16
200	315	11	8	3	13	15	13	16	16
250	250	15	8	8	15	17	16	17	18
250	315	15	7	6	13	15	14	16	17
250	400	14	5	4	12	13	13	14	16
315	315	7	10	9	13	16	15	17	21
315	400	7	8	9	12	15	15	16	19

Balancing

Balancing data is contained in a separate brochure.

Swirl diffuser

RCG

Technical data

RCG without box – supply air

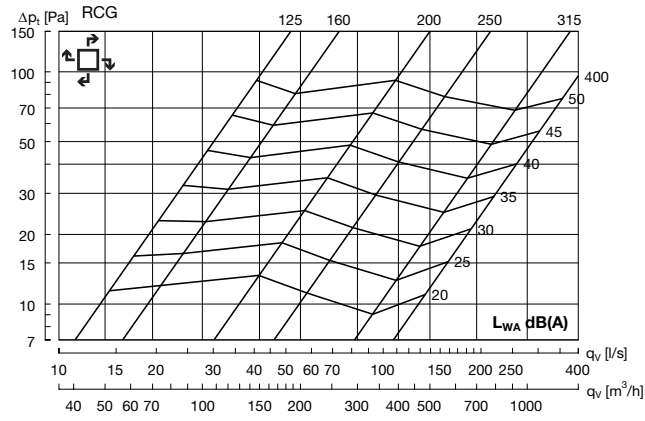

RCG 125 + MBB - Supply air

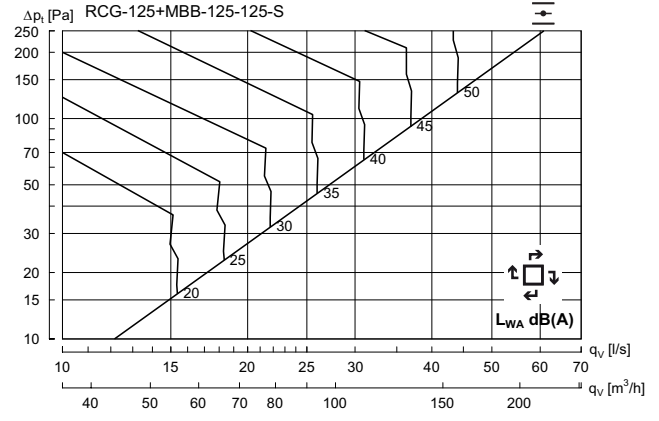

Hz	63	125	250	500	1K	2K	4K	8K
K_{ok}	14	5	2	-3	-7	-10	-20	-31

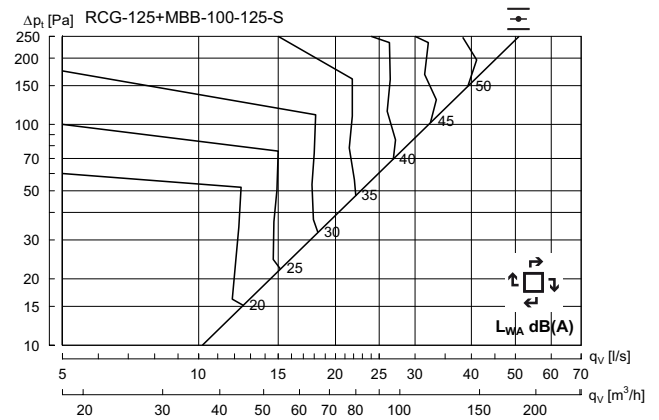

Hz	63	125	250	500	1K	2K	4K	8K
K_{ok}	9	4	4	-3	-7	-11	-22	-33

Swirl diffuser

RCG

Technical data

RCG 160 + MBB - Supply air

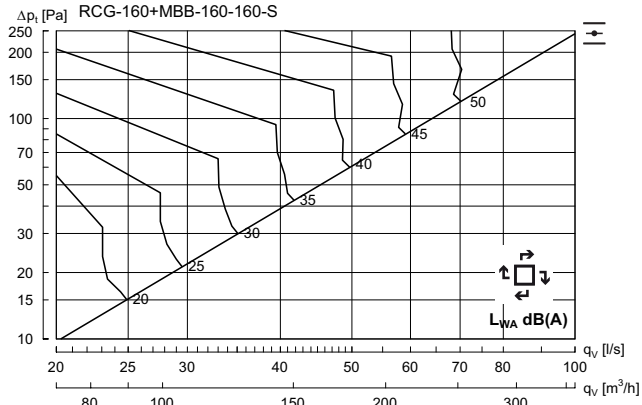

Hz	63	125	250	500	1K	2K	4K	8K
K_{ok}	5	7	3	-2	-7	-11	-22	-34

RCG 200 + MBB - Supply air

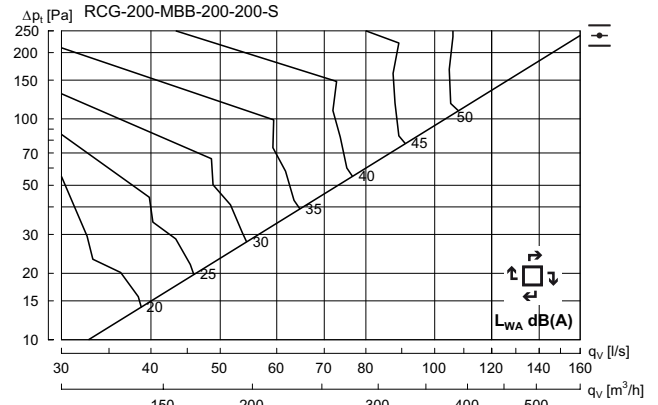

Hz	63	125	250	500	1K	2K	4K	8K
K_{ok}	14	7	2	-2	-6	-13	-24	-35

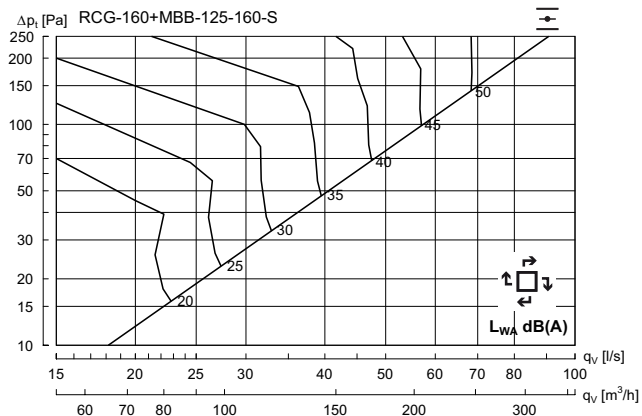

Hz	63	125	250	500	1K	2K	4K	8K
K_{ok}	8	5	4	-3	-7	-12	-22	-34

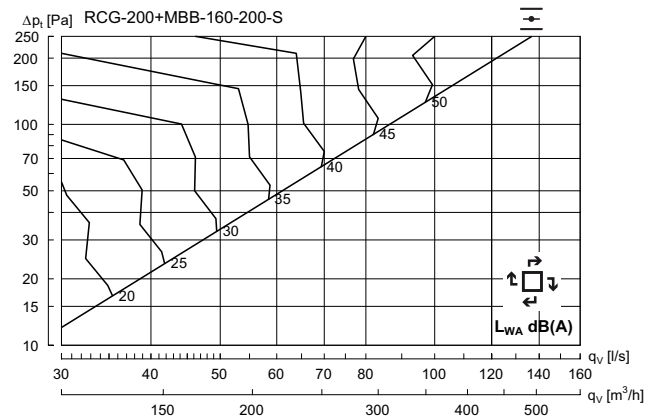

Hz	63	125	250	500	1K	2K	4K	8K
K_{ok}	11	7	3	-3	-7	-12	-22	-34

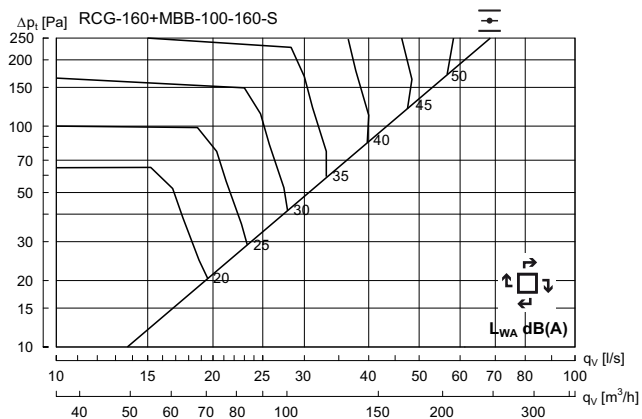

Hz	63	125	250	500	1K	2K	4K	8K
K_{ok}	12	4	4	-3	-7	-12	-20	-27

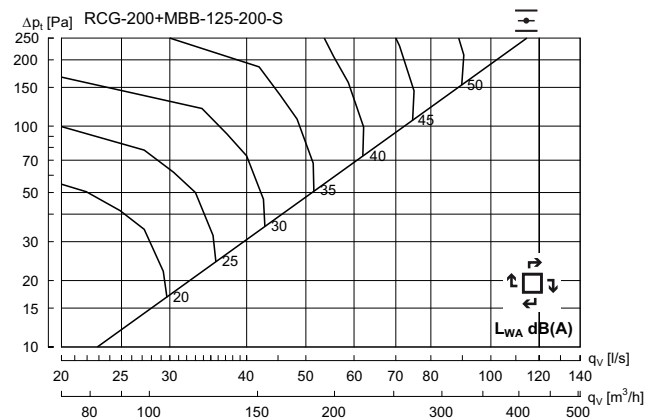

Hz	63	125	250	500	1K	2K	4K	8K
K_{ok}	10	5	5	-4	-8	-12	-18	-27

Swirl diffuser

RCG

Technical data

RCG 250 + MBB - Supply air

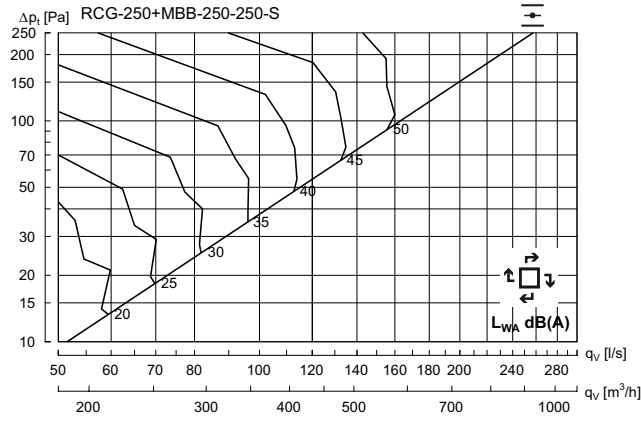

Hz	63	125	250	500	1K	2K	4K	8K
K_{ok}	10	6	2	-3	-5	-12	-21	-29

RCG 315 + MBB - Supply air

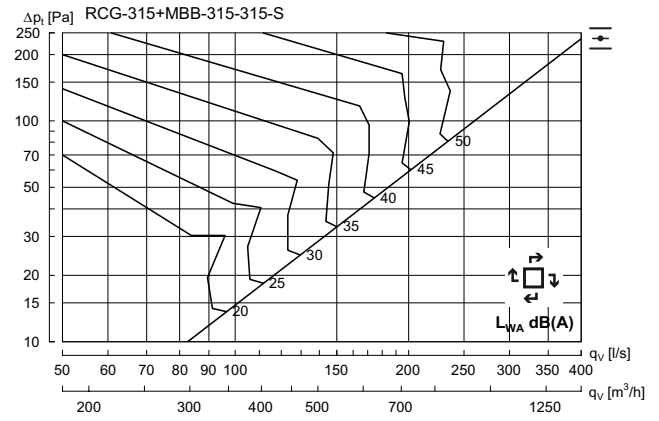

Hz	63	125	250	500	1K	2K	4K	8K
K_{ok}	12	4	2	-3	-4	-14	-22	-32

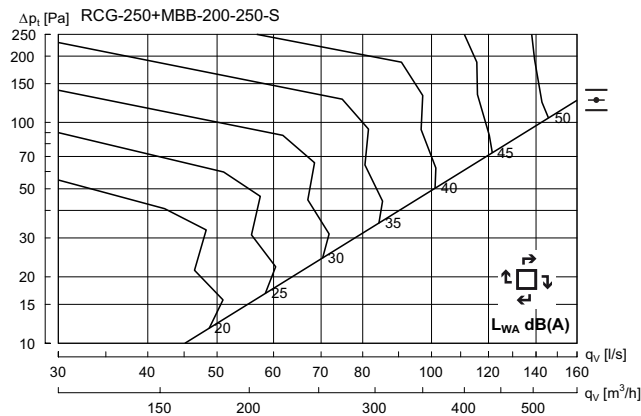

Hz	63	125	250	500	1K	2K	4K	8K
K_{ok}	8	7	3	-2	-6	-12	-22	-34

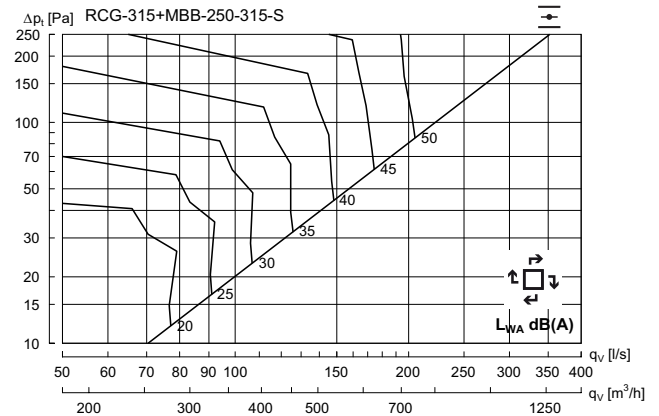

Hz	63	125	250	500	1K	2K	4K	8K
K_{ok}	10	7	3	-3	-6	-14	-22	-32

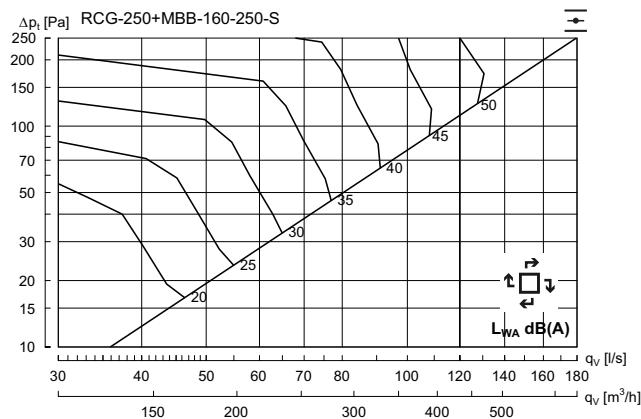

Hz	63	125	250	500	1K	2K	4K	8K
K_{ok}	12	6	3	-3	-7	-12	-20	-29

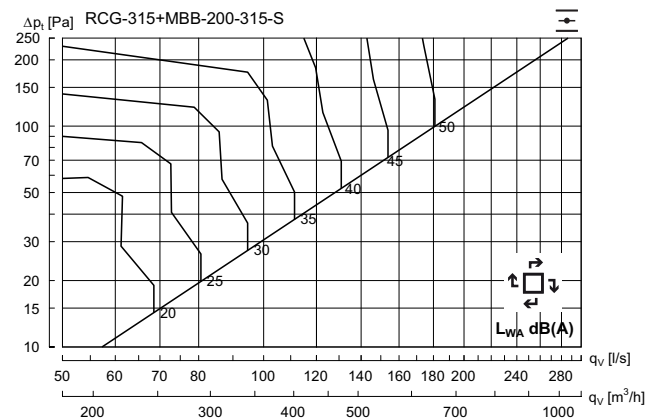

Hz	63	125	250	500	1K	2K	4K	8K
K_{ok}	9	7	3	-2	-6	-13	-22	-31

Swirl diffuser

RCG

Technical data

RCG 400 + MBB - Supply air

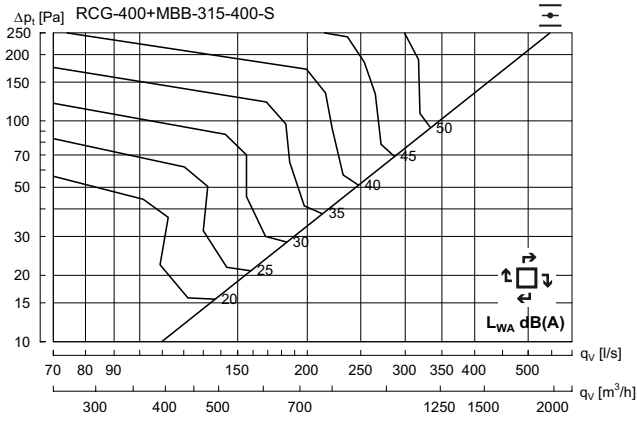

Hz	63	125	250	500	1K	2K	4K	8K
K_{ok}	10	5	2	-4	-5	-11	-20	-28

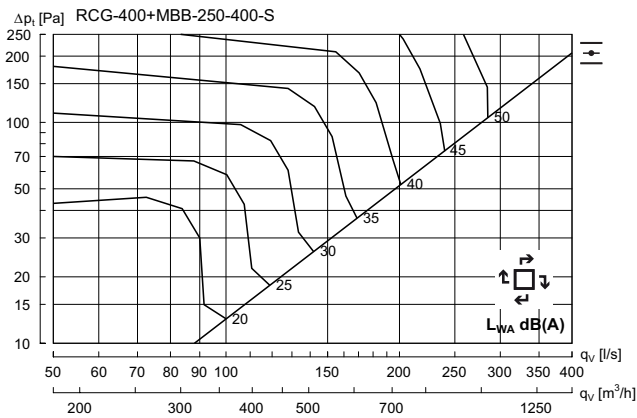

Hz	63	125	250	500	1K	2K	4K	8K
K_{ok}	9	6	2	-3	-5	-11	-19	-28

- 1
- 2
- 3
- 4
- 5
- 6
- 7
- 8
- 9
- 10
- 11
- 12
- 13
- 14
- 15
- 16
- 17
- 18

Plain diffuser

LCC



Dimensions

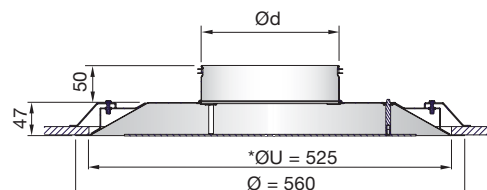

*ØU = Ceiling grid opening = 525 mm, all sizes.

LCC Ød mm	Weight kg
125	1.25
160	1.50
200	2.30
250	3.40
315	4.60

Description

LCC is a flush mounted circular diffuser with a circular unperforated face plate for installation in ceiling systems and permanent ceilings. LCC can be used for both supply and exhaust air. LCC is suitable for horizontal supply of cooled air and has a large dynamic range. Installing an LCC diffuser in a plenum box type MBB can help to achieve a stable airflow to the diffuser as well as realise the potential for individual adjustment.

- Simple and aesthetic appearance
- Large dynamic range
- Can be used for both supply and exhaust air

Maintenance

The faceplate can be removed to enable cleaning of internal parts or to gain access to the plenum box. the visible parts of the diffuser can be wiped with a damp cloth.

Technical data

For full documentation including Quick selection, sound diagrams, and K_{ok} -values, see LCP in the Integra chapter.

Ød = 125-250 => LCC has mounting holes for MBB

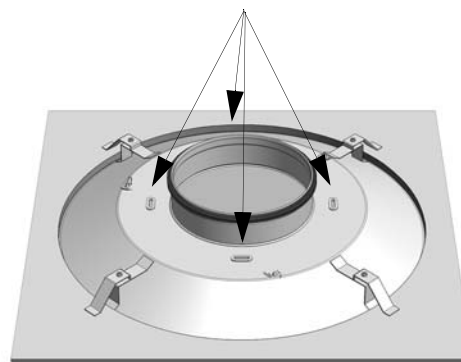

Ød = 315 => LCC has no mounting holes for MBB !

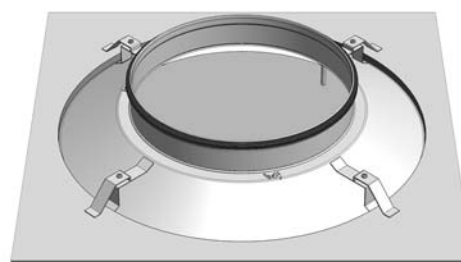

Brackets included for LCC, for details, see the Integra installation instruction.

Order code

Product	LCC	aaa
Type	LCC	
Connection dim.	Ød 125-315	

Example: LCC-160

Materials and finish

Upper part:	Galvanised steel
Face plate:	Aluminium
Face plate finish:	Powder coated
Standard colour:	RAL 9010, gloss 30

Other colours are available. Please contact Lindab's sales department for further information.

Plain diffuser

LKP/LCP



LKP

Description

LCP is a flush-mounted square diffuser with a circular unperforated face plate for installation in ceiling systems. LCP can be used for both supply and exhaust air. LCP is suitable for the horizontal supply of cooled air and has a large dynamic range. Installing an LCP diffuser in a plenum box type MBB can help to achieve a stable airflow to the diffuser as well as realise the potential for individual adjustment. LKP has a square face plate and the same properties as LCP.

- Simple and stylish appearance
- Large dynamic range
- Can be used for both supply and exhaust air
- Can be adapted to most ceiling systems

Maintenance

The face plate can be removed to enable cleaning of internal parts or to gain access to the duct or box. The visible parts of the diffuser can be wiped with a damp cloth.

Order code

Product	LCP/LKP	aaa	b
Type	LCP/LKP		
Connection dim.	Ød 125-315		
Ceiling system	1 - 14		

Example: LCP-160-1



LCP

Dimensions

LKP

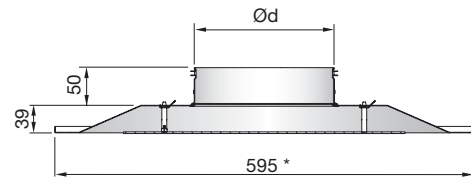

* ceiling system 1, other ceiling systems see Integra chapter page 122-123.

LCP

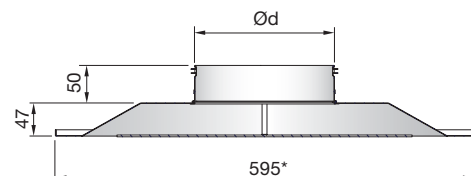

Ød = 315 => LCP has no mounting holes for MBB !

LKP/LCP Ød	Weight
mm	kg
125	3.2
160	3.2
200	3.3
250	3.4
315	3.5

Materials and finish

Grille box:	Galvanised steel
Face plate LKP:	Galvanised steel
Face plate LCP:	Aluminium
Face plate finish:	Powder-coated
Standard colour:	RAL 9010 Gloss 30

The diffuser is available in other colours. Please contact Lindab's sales department for further information.

Plain diffuser

LCC/LKP/LCP

Accessories

Plenum box

MBB



LKP + MBB

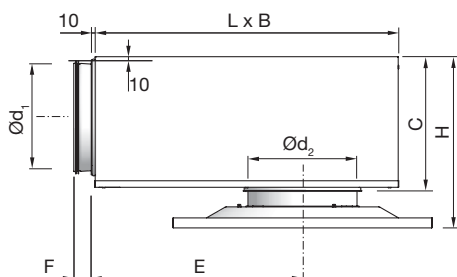

LKP + MBB		B mm	C mm	E mm	F mm	H* mm	L mm
duct Ød ₁ mm	LKP Ød ₂ mm						
100	125	260	159	216	50	198 - 238	310
100	160	260	159	216	50	198 - 238	310
125	125	310	184	262	50	223 - 263	376
125	160	310	184	262	50	223 - 263	376
125	200	310	184	262	50	223 - 263	376
160	160	380	220	323	50	257 - 297	459
160	200	380	220	323	50	257 - 297	459
160	250	380	220	323	50	257 - 297	459
200	200	460	259	396	70	298 - 338	565
200	250	460	259	396	70	298 - 338	565
200	315	460	259	396	70	298 - 338	565
250	250	540	309	486	70	348 - 388	698
250	315	540	309	486	70	348 - 388	698
315	315	540	373	648	70	413 - 453	858

* Using accessory MBZ the H dimension will increase:
 Ød₂ = 125 - 200 mm => H +40 mm
 Ød₂ = 250 - 315 mm => H +60 mm

Order code

Product **MBB** - aaa - bbb - c

Type

MBB

Duct connection Ød₁

Ø100-315

Diffuser dimension Ød₂

Ø125-315

Functional use

S = Supply air
 E = Exhaust

Example: LCP-160-1+MBB-160-160-S

Accessories

LCC + MBB

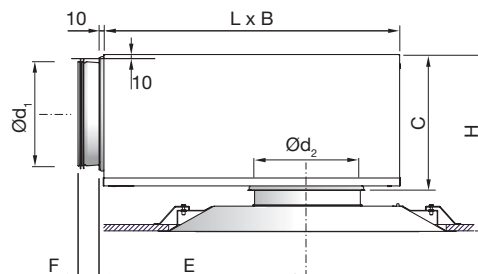

LCP + MBB

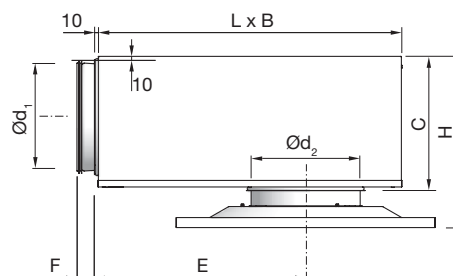

LCC / LCP + MBB		B mm	C mm	E mm	F mm	H* mm	L mm
duct Ød ₁ mm	LCP Ød ₂ mm						
100	125	260	159	216	50	206 - 246	310
100	160	260	159	216	50	206 - 246	310
125	125	310	184	262	50	231 - 271	376
125	160	310	184	262	50	231 - 271	376
125	200	310	184	262	50	231 - 271	376
160	160	380	220	323	50	265 - 305	459
160	200	380	220	323	50	265 - 305	459
160	250	380	220	323	50	265 - 305	459
200	200	460	259	396	70	306 - 346	565
200	250	460	259	396	70	306 - 346	565
200	315	460	259	396	70	306 - 346	565
250	250	540	309	486	70	356 - 396	698
250	315	540	309	486	70	356 - 396	698
315	315	540	373	646	70	421 - 461	858

* Using accessory MBZ the H dimension will increase:
 Ød₂ = 125 - 200 mm => H +40 mm
 Ød₂ = 250 - 315 mm => H +60 mm

Plain diffuser

LCC/LKP/LCP

Technical data

Capacity

Air flow q_v [l/s] and [m³/h], total pressure Δp_t [Pa], throw $l_{0,2}$ [m] and sound power level L_{WA} [dB(A)] can be seen in the diagrams.

Frequency-related sound effect level

The sound effect level in the frequency band is defined as $L_{WA} + K_{ok}$. K_{ok} values are specified in charts beneath the diagrams on the following pages.

Quick selection, supply air

LCC/LKP/LCP + MBB		$\Delta p_t \geq 50$ Pa		$\Delta p_t \geq 50$ Pa	
duct	LKP/LCP	30 dB(A)		35 dB(A)	
$\varnothing d_1$	$\varnothing d_2$	l/s	m ³ /h	l/s	m ³ /h
100	125	37	133	44	158
100	160	39	140	48	173
125	125	48	173	56	202
125	160	56	202	66	238
125	200	61	220	73	263
160	160	67	241	85	306
160	200	79	284	99	356
160	250	95	342	113	407
200	200	92	331	117	421
200	250	105	378	122	439
200	315	118	425	145	522
250	250	112	403	132	475
250	315	131	472	168	605
315	315	144	518	169	608

Throw $l_{0,2}$

Throw $l_{0,2}$ [m] can be seen in the diagram for isothermal air, at a terminal velocity of 0.2 m/s.

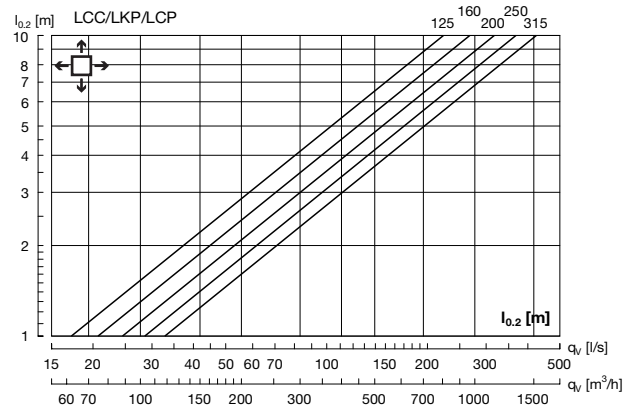

Sound attenuation

Sound attenuation of the diffusers ΔL from duct to room, including end reflection, see table below.

LCC/LCP/LKP + MBB		Centre frequency Hz							
duct	LCC/LCP/LKP	63	125	250	500	1K	2K	4K	8K
$\varnothing d_1$	$\varnothing d_2$								
100	125	17	15	10	17	15	18	19	21
100	160	17	16	6	10	18	18	18	21
125	125	17	15	10	17	15	18	19	21
125	160	15	14	10	17	16	17	18	21
125	200	13	12	7	13	13	16	17	18
160	160	17	15	12	21	19	19	21	21
160	200	17	16	10	20	17	17	19	20
160	250	16	14	7	17	15	16	19	20
200	200	13	11	10	17	18	15	19	18
200	250	14	11	8	15	19	15	18	17
200	315	14	9	7	13	18	14	17	17
250	250	15	10	9	17	18	18	19	19
250	315	15	8	9	16	18	16	18	18
315	315	8	10	10	17	18	17	18	24

Balancing

Balancing data is contained in a separate brochure.

Plain diffuser

LCC/LKP/LCP

Technical data

LCC/LKP/LCP without box – supply air

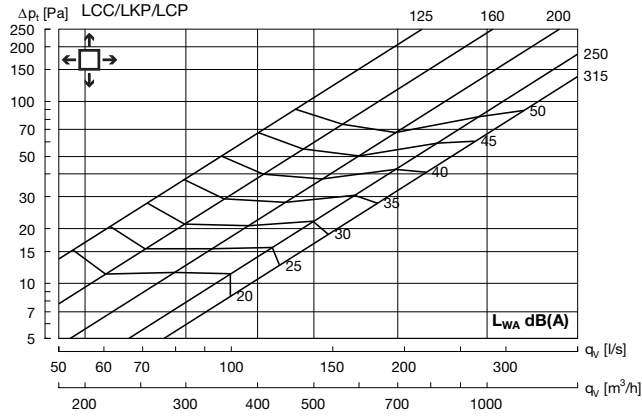

LCC/LKP/LCP 125 + MBB - Supply air

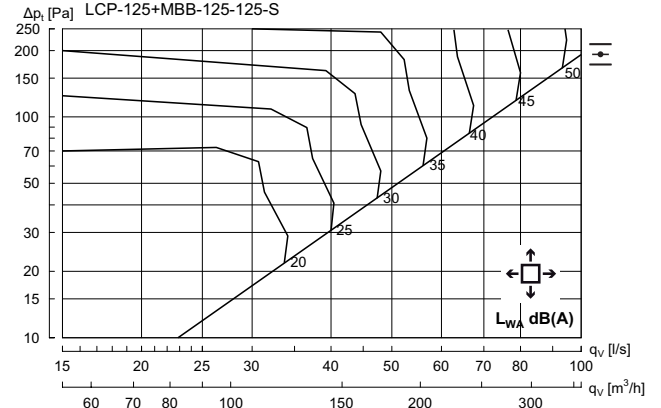

Hz	63	125	250	500	1K	2K	4K	8K
K _{ok}	13	7	1	-2	-6	-14	-20	-25

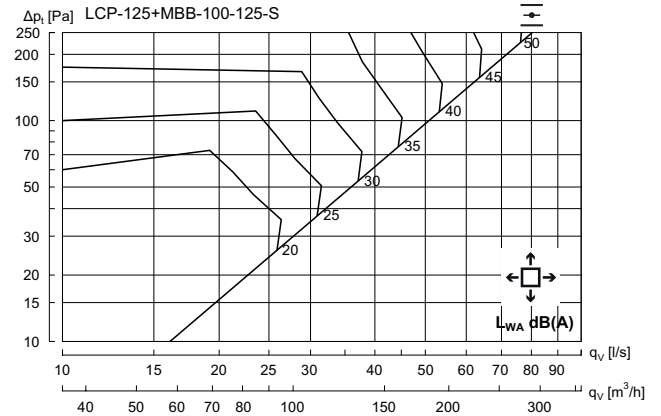

Hz	63	125	250	500	1K	2K	4K	8K
K _{ok}	10	4	2	-2	-6	-10	-17	-23

Plain diffuser

LCC/LKP/LCP

Technical data

LCC/LKP/LCP 160 + MBB - Supply air

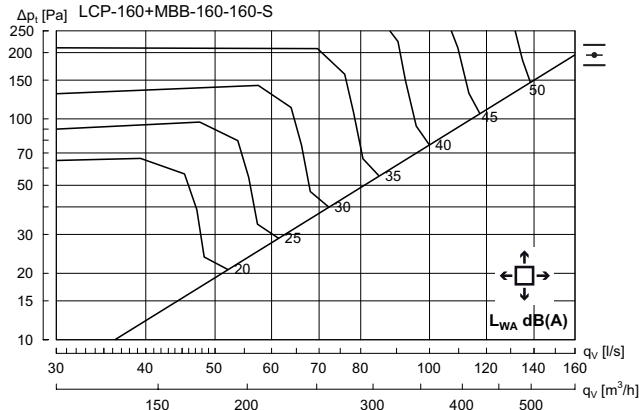

Hz	63	125	250	500	1K	2K	4K	8K
K_{ok}	13	8	0	-3	-6	-10	-19	-25

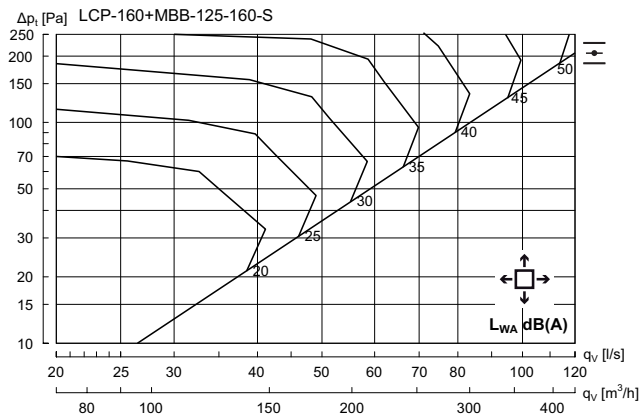

Hz	63	125	250	500	1K	2K	4K	8K
K_{ok}	9	8	1	-3	-6	-11	-16	-22

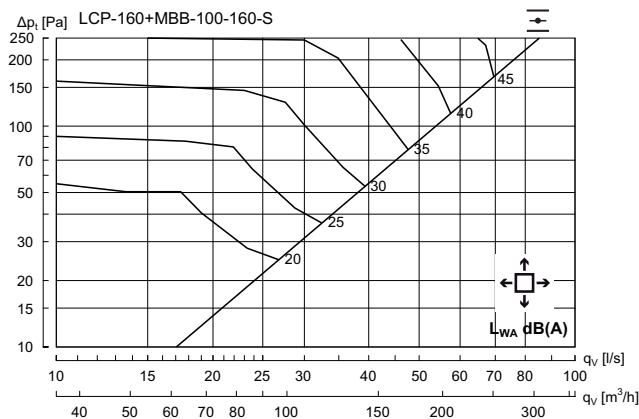

Hz	63	125	250	500	1K	2K	4K	8K
K_{ok}	9	5	0	-1	-7	-10	-16	-21

LCC/LKP/LCP 200 + MBB - Supply air

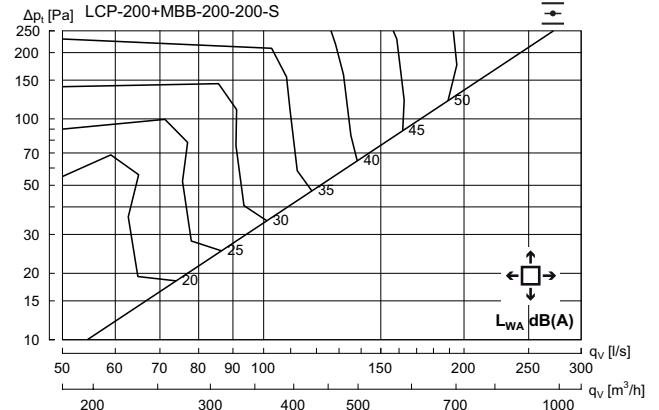

Hz	63	125	250	500	1K	2K	4K	8K
K_{ok}	12	8	0	-3	-5	-14	-21	-24

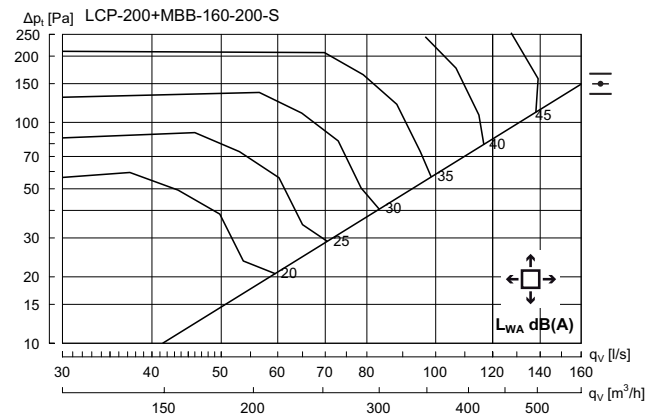

Hz	63	125	250	500	1K	2K	4K	8K
K_{ok}	12	7	-1	-3	-5	-10	-15	-21

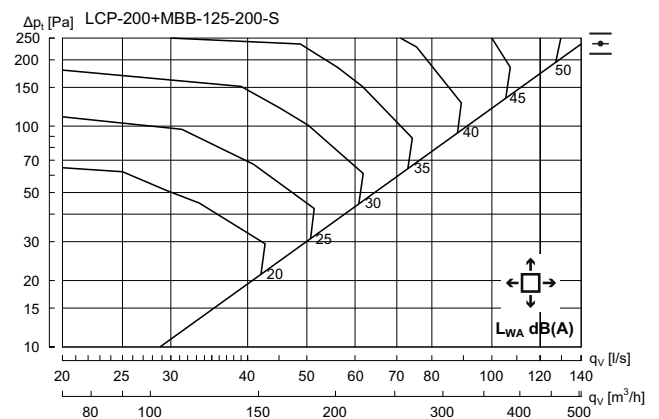

Hz	63	125	250	500	1K	2K	4K	8K
K_{ok}	6	6	0	-3	-5	-9	-16	-21

Plain diffuser

LCC/LKP/LCP

Technical data

LCC/LKP/LCP 250 + MBB - Supply air

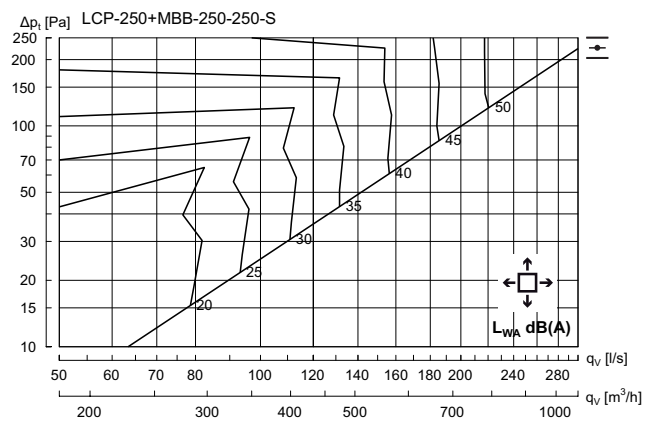

Hz	63	125	250	500	1K	2K	4K	8K
K_{ok}	15	6	-1	-1	-5	-15	-23	-29

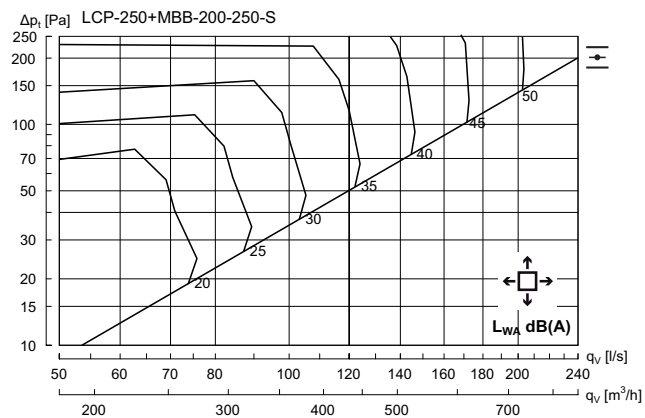

Hz	63	125	250	500	1K	2K	4K	8K
K_{ok}	13	8	-1	-2	-5	-13	-20	-26

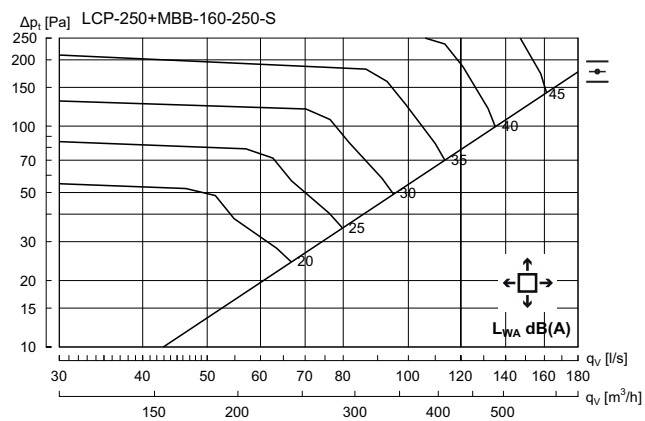

Hz	63	125	250	500	1K	2K	4K	8K
K_{ok}	13	7	0	-4	-5	-11	-16	-22

LCC/LKP/LCP 315 + MBB - Supply air

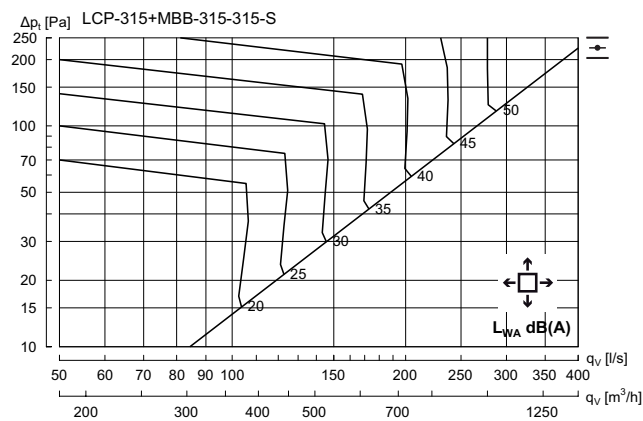

Hz	63	125	250	500	1K	2K	4K	8K
K_{ok}	12	4	0	-2	-4	-14	-19	-27

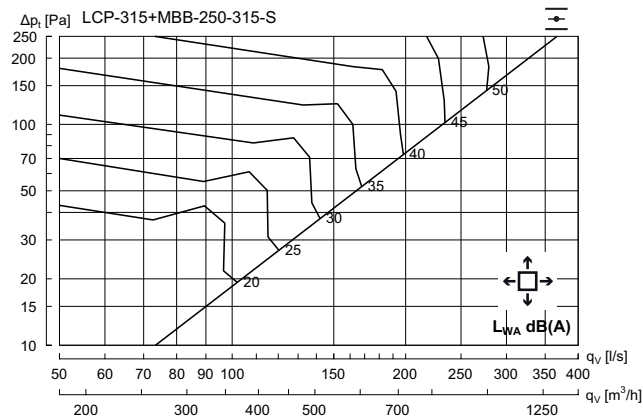

Hz	63	125	250	500	1K	2K	4K	8K
K_{ok}	13	7	0	-2	-6	-10	-17	-23

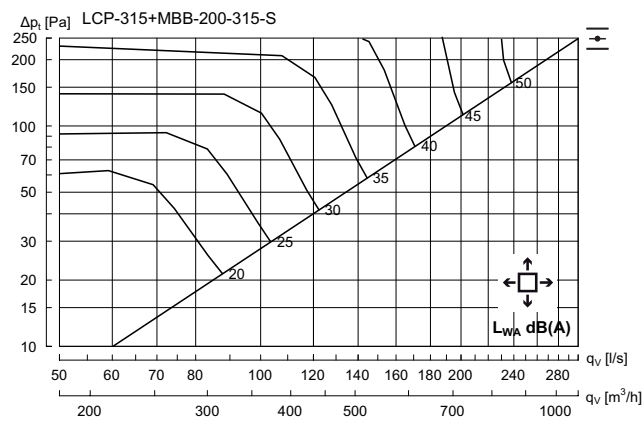

Hz	63	125	250	500	1K	2K	4K	8K
K_{ok}	12	10	0	-3	-6	-12	-19	-24

Plain diffuser

LCC/LKP/LCP

Technical data

LCC/LKP/LCP without box – Exhaust

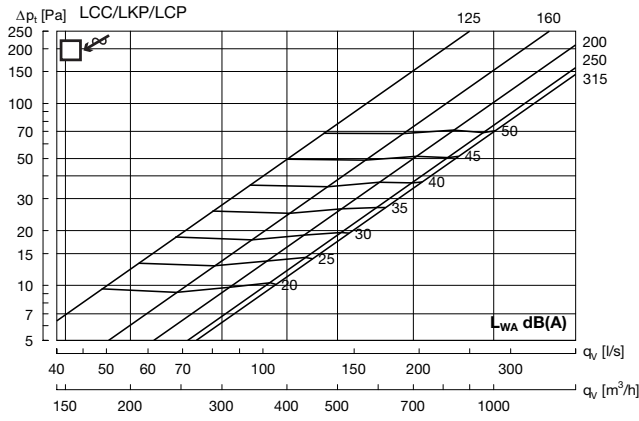

LCC/LKP/LCP 125 + MBB - Exhaust air

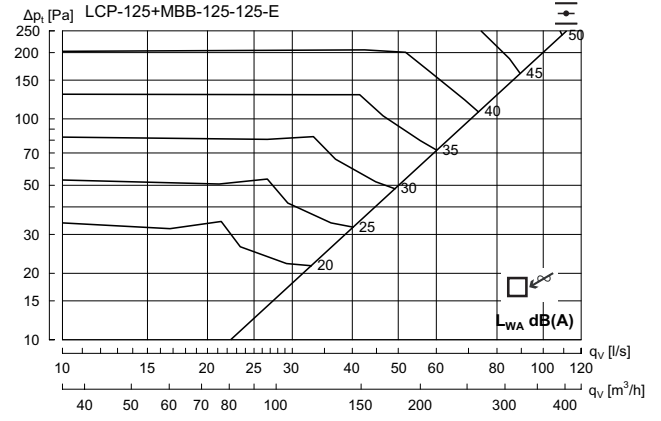

Hz	63	125	250	500	1K	2K	4K	8K
K _{ok}	12	4	-1	-1	-6	-12	-16	-22

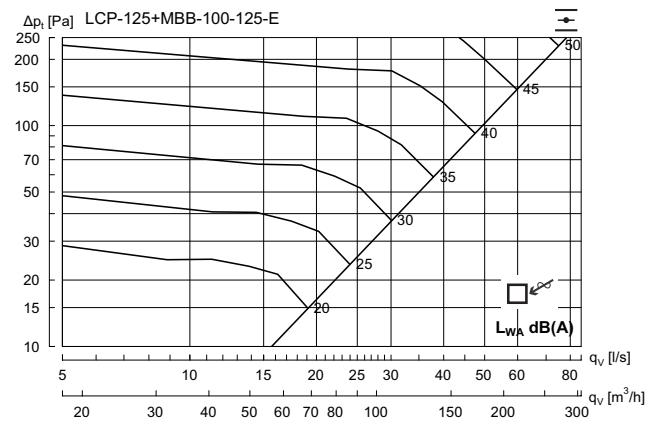

Hz	63	125	250	500	1K	2K	4K	8K
K _{ok}	13	-1	3	-1	-9	-11	-17	-23

- 1
- 2
- 3
- 4
- 5
- 6
- 7
- 8
- 9
- 10
- 11
- 12
- 13
- 14
- 15
- 16
- 17
- 18

Plain diffuser

LCC/LKP/LCP

Technical data

LCC/LKP/LCP 160 + MBB - Exhaust air

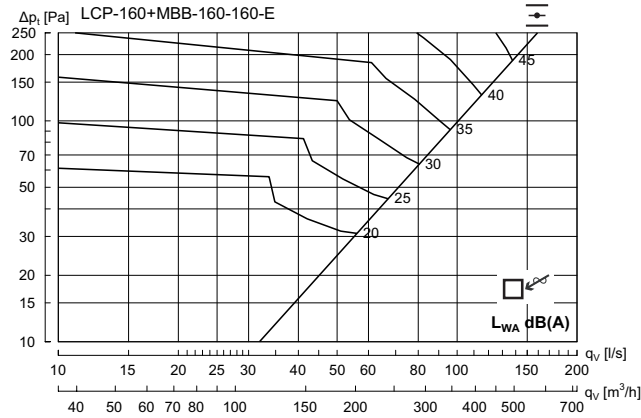

Hz	63	125	250	500	1K	2K	4K	8K
K_{ok}	16	4	-1	-2	-5	-10	-16	-21

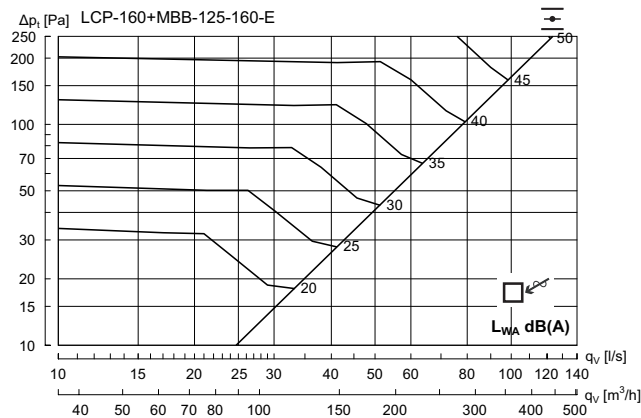

Hz	63	125	250	500	1K	2K	4K	8K
K_{ok}	14	5	0	-1	-6	-11	-15	-21

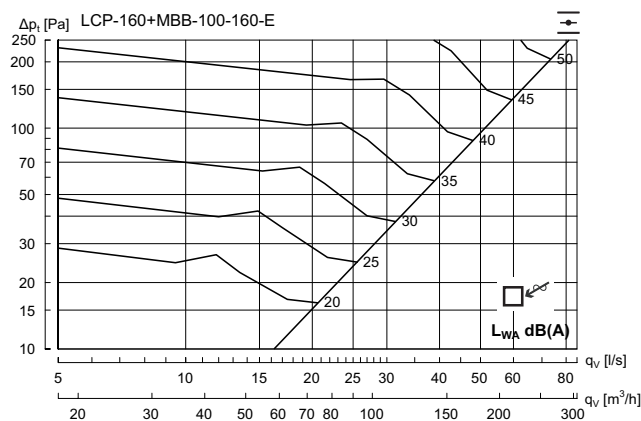

Hz	63	125	250	500	1K	2K	4K	8K
K_{ok}	11	3	2	0	-8	-13	-17	-23

LCC/LKP/LCP 200 + MBB - Exhaust air

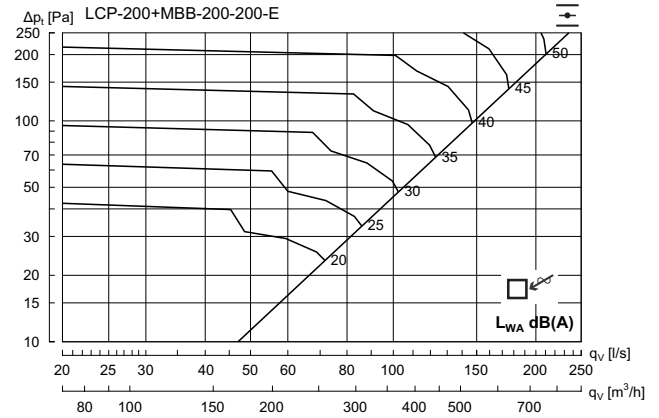

Hz	63	125	250	500	1K	2K	4K	8K
K_{ok}	15	5	0	-2	-6	-10	-15	-23

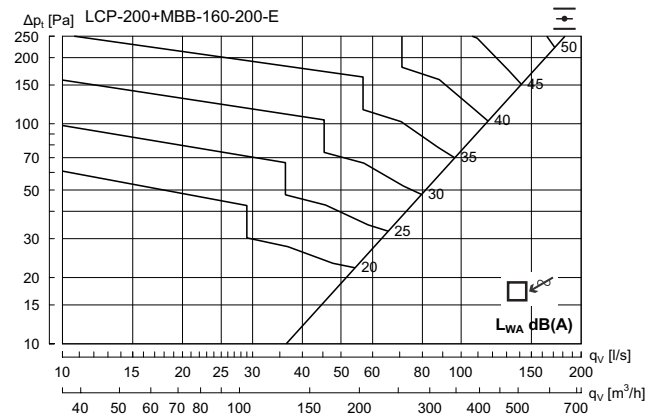

Hz	63	125	250	500	1K	2K	4K	8K
K_{ok}	16	5	-1	-3	-5	-10	-15	-21

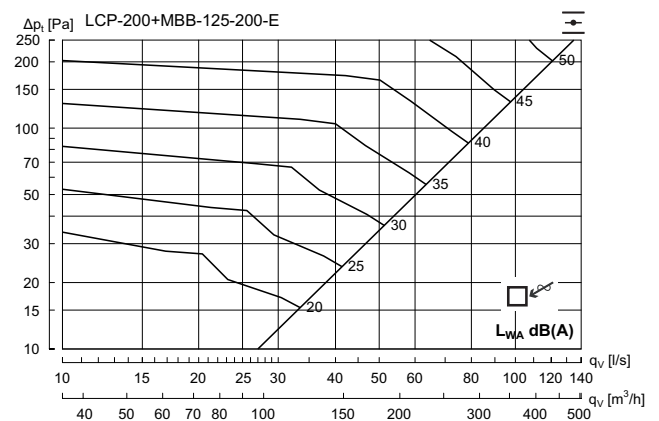

Hz	63	125	250	500	1K	2K	4K	8K
K_{ok}	11	3	-1	-2	-5	-10	-16	-22

Plain diffuser

LCC/LKP/LCP

Technical data

LCC/LKP/LCP 250 + MBB - Exhaust air

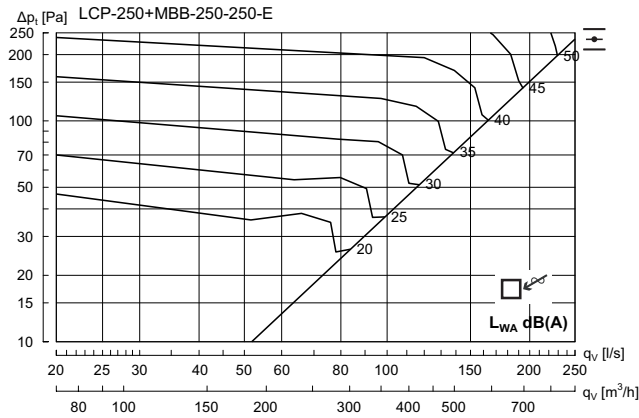

Hz	63	125	250	500	1K	2K	4K	8K
K_{ok}	11	4	1	-2	-5	-11	-17	-25

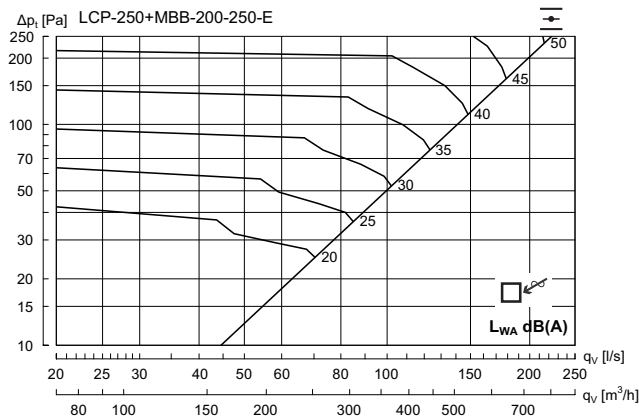

Hz	63	125	250	500	1K	2K	4K	8K
K_{ok}	14	4	0	-2	-6	-11	-16	-25

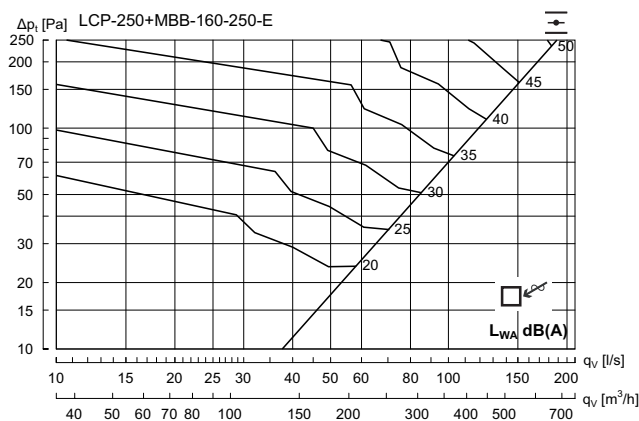

Hz	63	125	250	500	1K	2K	4K	8K
K_{ok}	19	6	-1	-4	-5	-12	-18	-26

LCC/LKP/LCP 315 + MBB - Exhaust air

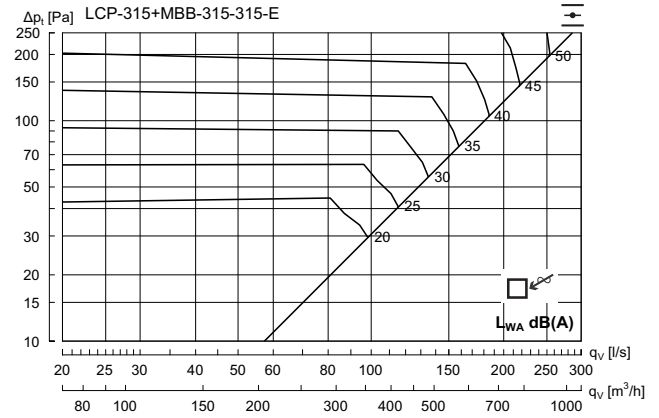

Hz	63	125	250	500	1K	2K	4K	8K
K_{ok}	12	4	2	-3	-6	-9	-18	-27

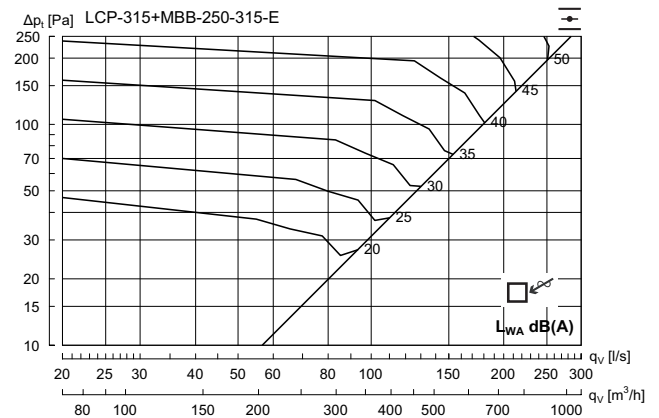

Hz	63	125	250	500	1K	2K	4K	8K
K_{ok}	12	5	2	-3	-6	-10	-17	-24

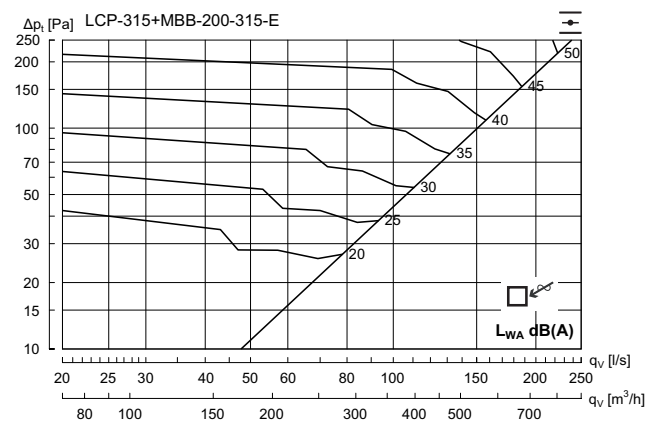

Hz	63	125	250	500	1K	2K	4K	8K
K_{ok}	14	5	0	-3	-5	-10	-16	-25