

ENGINEERING  
TOMORROW

*Danfoss*

District heating application handbook

# Making applications future proof

all our knowledge - is now yours

**+30**

**years of experience**

in district heating  
applications, with  
more than 5 million  
installations worldwide.

districtenergy.danfoss.com

[www.districtenergy.danfoss.com](http://www.districtenergy.danfoss.com)

# Index

## District heating application handbook

### Introduction to the handbook .....3

- 4 District heating from the inside
- 6 Matching district heating to building needs
- 8 How to read this book
- 9 Application benchmarking
- 10 District heating application types – overview

### General principles ..... 13

- 14 Hydronic balancing – control types
- 16 Hydronic balancing – control functions
- 18 Idling functions
- 21 Weather compensation

### Recommended applications ..... 23

- 27 1. Domestic hot water applications
- 35 2. Indirectly and directly connected room heating applications
- 43 3. Supply systems to flat stations applications
- 53 4. Directly and indirectly connected room heating and instantaneous domestic hot water heat exchanger applications
- 63 5. Directly and indirectly connected room heating and domestic hot water charging tank applications
- 71 6. Directly and indirectly connected room heating and domestic hot water cylinder applications
- 79 7. Two-step applications
- 85 8. Indirectly connected room heating and secondary side connected domestic hot water charging tank application S.1.2
- 89 9. Indirectly connected room heating and secondary side connected domestic hot water cylinder application S.1.3

### About Danfoss District Energy .....92

### Appendix ..... 96

- 98 Abbreviations
- 98 Application symbols
- 99 Reference list

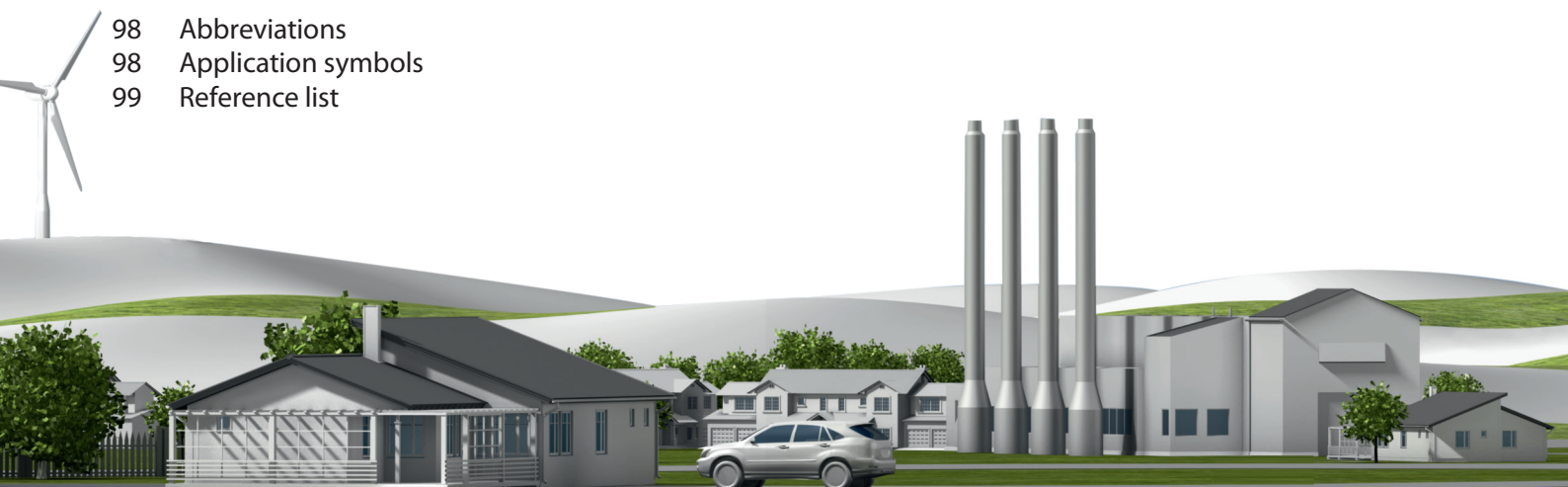

# Introduction to the handbook

- District heating from the inside
- The relevance of district heating
- Matching district heating to building needs



# District heating from the inside

**113 million**  
metric tons of CO<sub>2</sub>

are saved per year in Europe through district heating supplying 9-10% of the heat demand.

**For more than 35 years, Danfoss has been taking an active role working in close cooperation with customers to offer the right solutions for district heating systems.**

No matter the project size, no matter the specification, Danfoss components and substations excel throughout the world.

This is the platform for sharing experience, application expertise and making recommendations on optimum performing district heating applications and key applied control components.



*Application knowledge*

**Danfoss recommendations**



## Background for this book

Version 1.0  
Year 2012  
1st edition

Editorial Office:  
Danfoss A/S – District Energy  
Nordborgvej 81  
DK-6430 Nordborg  
Denmark  
[districtenergy.danfoss.com](http://districtenergy.danfoss.com)

Contact:  
District Energy – Application Centre:

Jan Eric Thorsen, Manager  
Phone: + 45 7488 4494  
E-mail: [jet@danfoss.com](mailto:jet@danfoss.com)

Oddgeir Gudmundsson, Application Specialist,  
Phone: + 45 7488 2527,  
E-mail: [og@danfoss.com](mailto:og@danfoss.com)

Danfoss District Energy is the leading supplier of products, systems and services for district heating and cooling (DHC), with decades of experience in the industry.

In this way, Danfoss provides customers worldwide with expertise and knowledge that bring truly energy-efficient solutions to life.

# Green district District heating

District heating and cooling networks provide an ideal fit in the heart of a green city or district. In dense urban environments where heat demand is inevitably highest, they are the ideal means of exploiting locally available streams of renewable energy and surplus heat supply for a useful purpose. Such systems generate significant, provable reductions of primary energy consumption, cut CO<sub>2</sub> emissions and provide citizens with the standard of comfort and reliability they expect.

### Network conditions and system design

District heating networks differ in size, layout and conditions in cities and urban areas around the world. To achieve the ideal level of performance and user comfort, temperature settings, operating pressure level as well as technical building connection requirements need to be appropriate to ensure reliable supply and operational safety.

### Influencing trends in district heating

Today, the heating sector is influenced by multiple trends. These are driven by increased user expectations of comfort and supply security, product design and usability as well as energy-efficient performance prescribed by legislation. This has led to district heating application design needing to offer:

- Reduced temperature and pressure levels in DH networks
- Energy-efficient operation with higher levels of control performance
- Monitoring of energy performance and billing according to individual consumption
- Secure and safe heat supply

### District heating from 1G to 4G

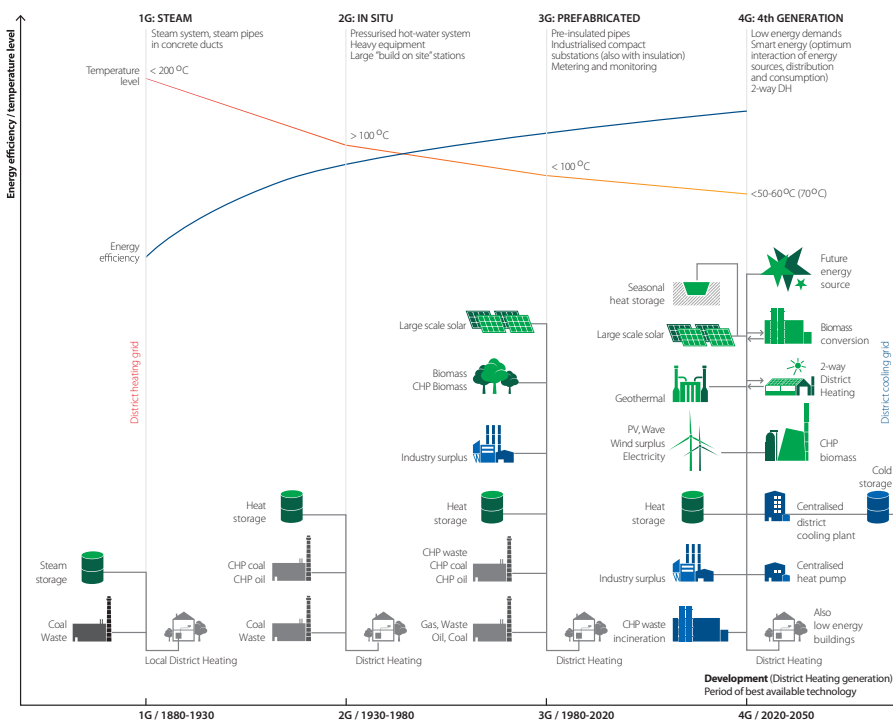

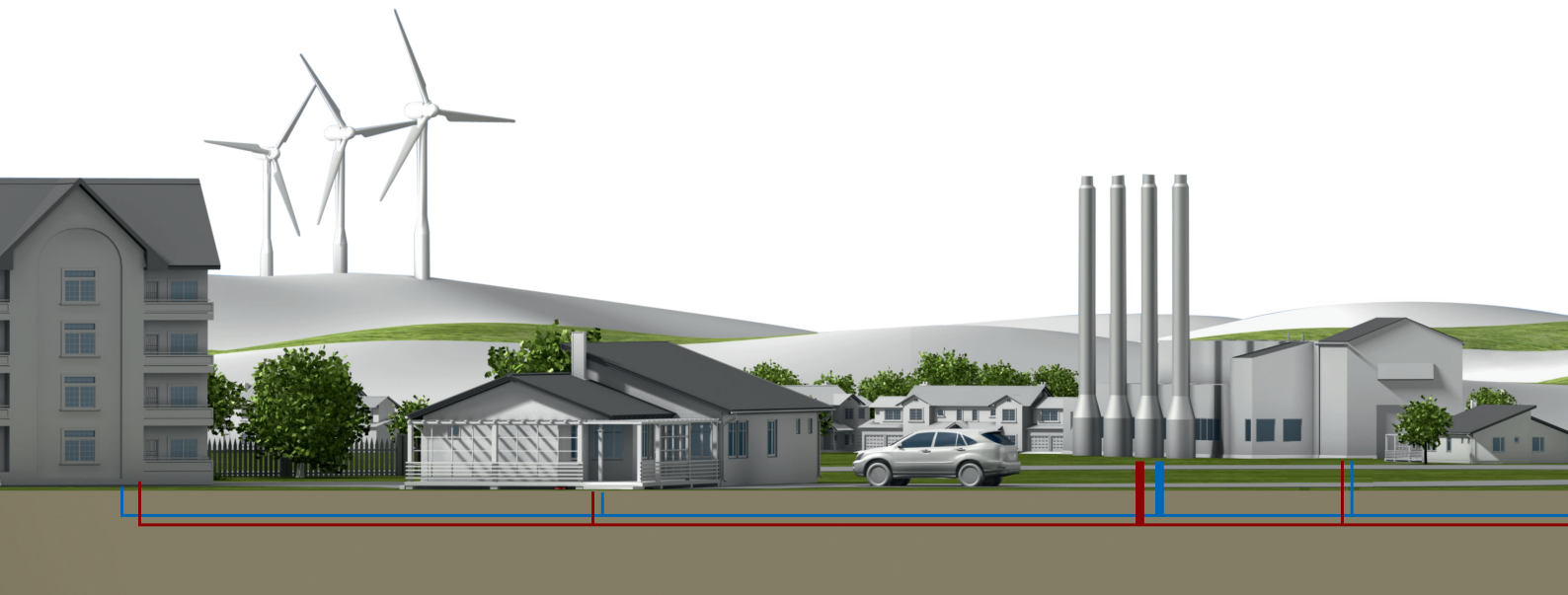

## Matching district heating ...

### System infrastructure and available heat sources

Where available, district heating is the best heat source you can choose. District heating is good for you financially and good for society as a whole. Where district heating is not available, try to make the best use of the available alternatives, especially renewable energy. The best solution is always when you succeed in matching the system infrastructure and design with the available supply of energy sources, building type and your customers' specific needs.



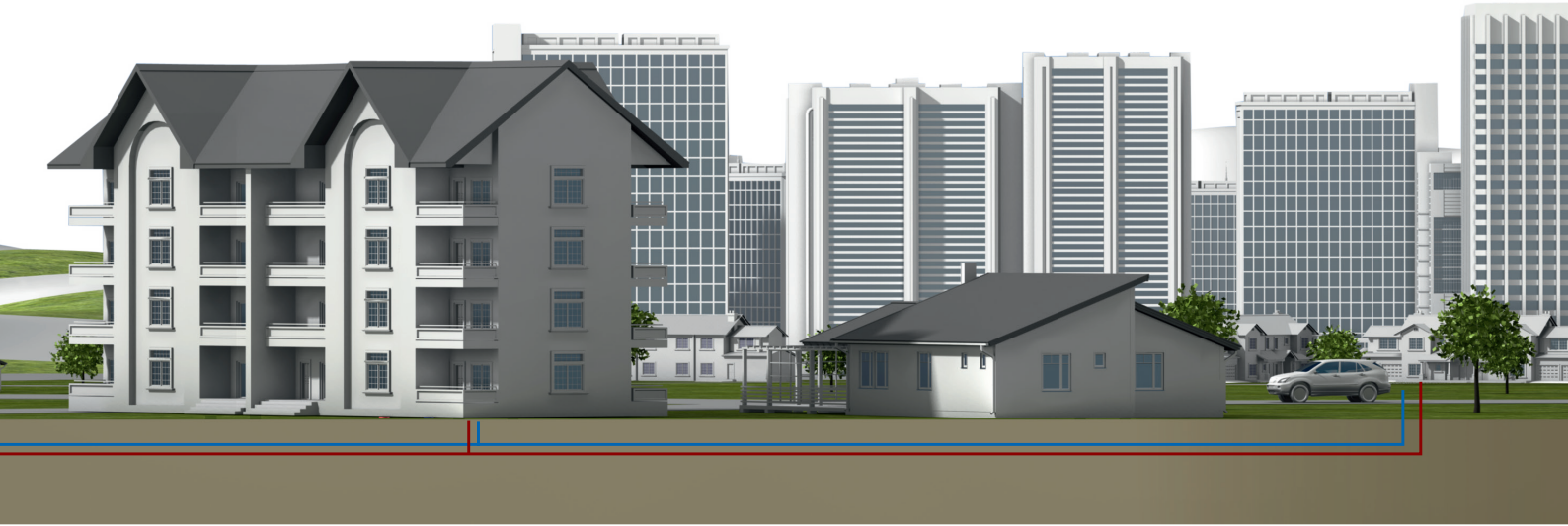

## ... to building needs

### Examples of how controls optimize heat systems

#### 1. Adjusting to outside temperatures

When flow temperature in the heating system reflects outside temperature, the user will enjoy both increased comfort and lower heating bills. In one-family homes, the expected energy saving from weather compensation is 10% on average and can be as high as 40%.

#### 2. Using available energy sources

Whether a building uses single or multiple heat sources, correct control mechanisms ensure optimum output and match supply to the actual needs of the building. In this way, comfort is kept high and energy consumption low.

#### 3. Balance = savings and comfort

A properly hydronic-balanced heating system supplies the correct heating capacity to all rooms, regardless of load conditions. Energy is saved because temperatures match the need in every part of the heating system.

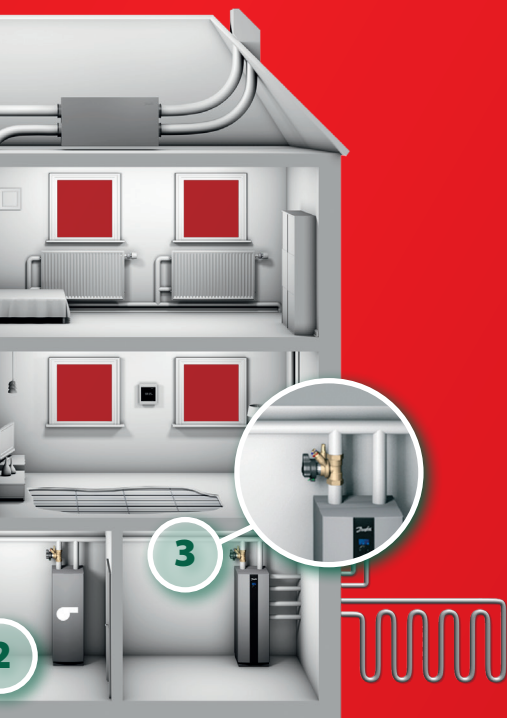

# A comprehensive overview

When connecting a building to district heating, different options are available for heating and preparation of domestic hot water.

**The aim of this handbook is to give a comprehensive overview of different applications with a special focus on applications recommended by Danfoss.**

All applications are illustrated and described, including how they work and what options are available.

For the recommended applications, you will find key benefits and limitations, benchmarking, comparison of different applications and documented values.

**All applications are prioritized using the following symbols:**



**Danfoss-recommended application**



**Primary alternative to Danfoss-recommended application**



**Secondary alternative to Danfoss-recommended application**

## Principle and purpose of application benchmarking

Qualitative as well as quantitative measures are included, supporting the understanding of the benefits and limitations on the various applications.

The intention is not to give product-specific information or detailed theory behind the components or applications.

For product-specific information, we refer to data sheets belonging to the product groups. For detailed theory, we refer to technical papers and relevant scientific material in general.

Benchmark parameter	Description
<b>Investment cost saving</b> 	Cost of purchasing the heating system and the necessary components
	Reduced design and planning time for consultants/designers
<b>Installation time saving</b> 	Time needed for installing and commissioning the heating system
	Weight of the installation
	System complexity
<b>Space requirement savings</b> 	Ability to free-up space in the building that can then be used for other purposes
	More compact heating system installation
<b>Service/maintenance savings</b> 	Compliance with DHW legislation (3 liter) – only currently in Germany
	Low DHW system volume limits legionella growth
	Instantaneous DHW preparation limits legionella growth compared to DHW circulation
	Simplicity and robustness of system
	Reduced number and duration of service visits will lead to lower service/maintenance costs
	Lower temperature, pressure level and heat loss in the DH network and in the heating system
<b>Energy-efficiency performance</b> 	Heat transfer effectiveness of heating system (HEX)
	Lower return temperature back to the station and network
	Weather compensation of the heating system
	Highly efficient heating system
	Energy-saving potential
	Secondary temperature adapted/optimized to the building heat load
	Lower hydronic load to a group of customers due to HEX solution (less heat loss and pump energy)
	DHW quality, avoid bacteria growth – no storage of hot water by instantaneous production of DHW, compliance with DHW legislation (3 liter) – only currently in Germany
<b>System operation safety</b> 	Risk of leakage and contamination of DH water supply
	Risk of exposure to high temperatures (e.g. radiator surface)
	Unlimited amount of DHW
<b>User comfort</b> 	Optimum room temperatur level
	Indoor climate
	Length of maintenance cycle (if maintenance cycle is long, there is long time between supply stops)
	System noise
	Waiting time for hot water

# Application type overview

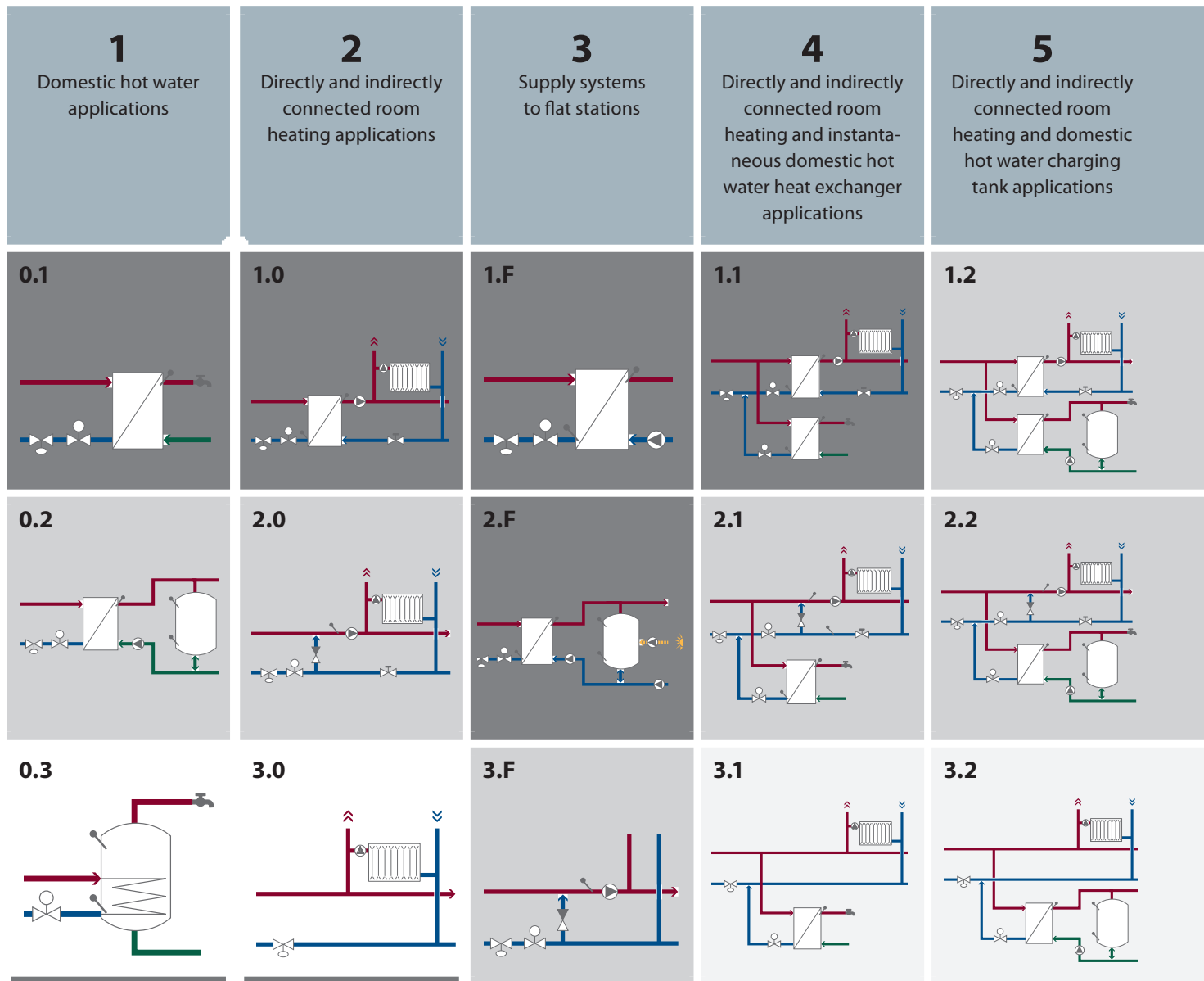

When connecting a building to DH, many options are available for heating the building and for the preparation of domestic hot water. In this handbook, a numbering system is used for different applications that relate to the numbering of their basic components, type of HE and DHW applications e.g. application 1.1 Directly connected HE and instantaneous DHW, which is a combination of applications 1.0 Directly connected HE and 0.1 Instantaneous DHW.

**6**

Directly and indirectly connected room heating and domestic hot water cylinder applications

**7**

Two-step applications

**8**

Indirectly connected room heating and secondary side connected domestic hot water charging tank application

**9**

Indirectly connected room heating and secondary side connected domestic hot water cylinder application

**1.3**

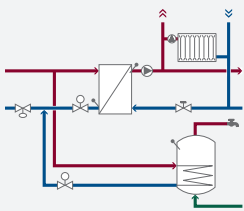

**1.1.1**

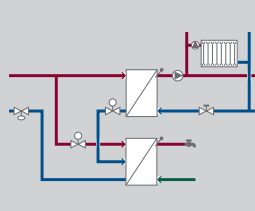

**S.1.2**

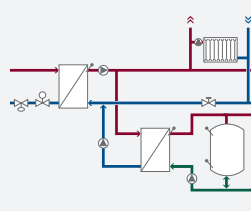

**S.1.3**

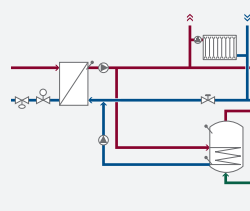

**2.3**

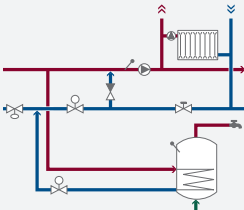



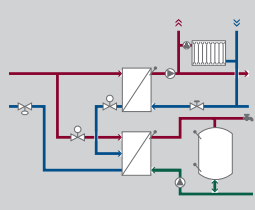

**1.1.2**

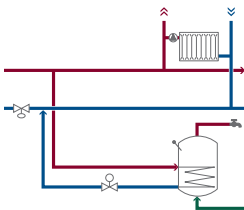

**3.3**

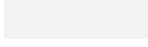

-  Danfoss-recommended application
-  Primary alternative to Danfoss-recommended application
-  Secondary alternative to Danfoss-recommended application
-  Not recommended by Danfoss

Application 0.1 + Application 1.0 = Application 1.1

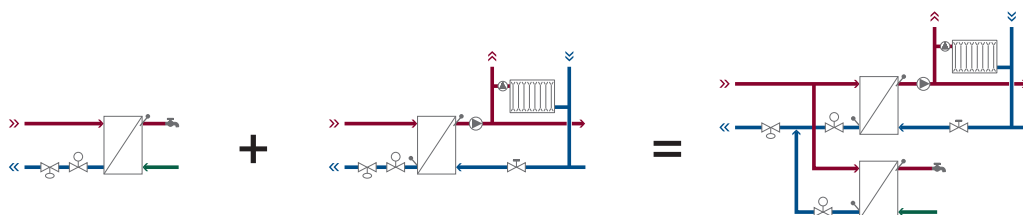

ECL Comfort 310

M1 P1



*Daifort*



# General principles

Excellent operation of district heating substations is directly related to the design of the secondary heating system, the heat exchanger and the control equipment on the primary DH network supply side. Daily and seasonal variations in consumption cause the differential pressure to fluctuate markedly as the flow varies in the primary supply. This affects control of the supply to the substation in the building. For this reason, specific demands must be met for control and hydronic balancing of the substation and the heating system.

The necessary flow rate to a substation is determined by the heat demand of the connected buildings. Heat demand is typically compiled by three parameters: room heat consumption, ventilation and domestic hot water (DHW) requirements.

- Hydronic balancing
  - Control types
  - Control functions
  - Idling functions for DHW only
- Weather compensation

## Control types

# Flow controllers, differential pressure controllers and flow limiters

The purpose of applying differential pressure (dP) controllers, flow controllers and flow limiters is to establish a good hydronic balance in the DH network. Good hydronic balance in the DH network means that every consumer has the DH flow needed according to specification, with no excess DH flow. By applying a dP controller the operating conditions for the control valve is significantly improved.

### Benefits:

- Well-defined specification for valve sizing
- Simple adjustment of the substation
- Stabilization of temperature control
- Lower noise level in the system
- Prolonged lifespan of the control equipment
- Good distribution of water in the supply network
- Delimitation of the circulating water quantity in the network

## Flow controller

Flow controlling in an indirect connected DH heating system.

The flow controller will ensure that the maximum preset flow of DH supply is not exceeded. Flow controlling is used in systems where the variation of differential pressure is low, and where a maximum DH flow is not to be exceeded, independent of the system differential pressure. Typically, this controller is used in indirect connected systems, where the max. flow rate is used as a tariff system, and in systems where the max. flow limitation is lower than max. capacity of the system, i.e. where a DHW priority function is applied.

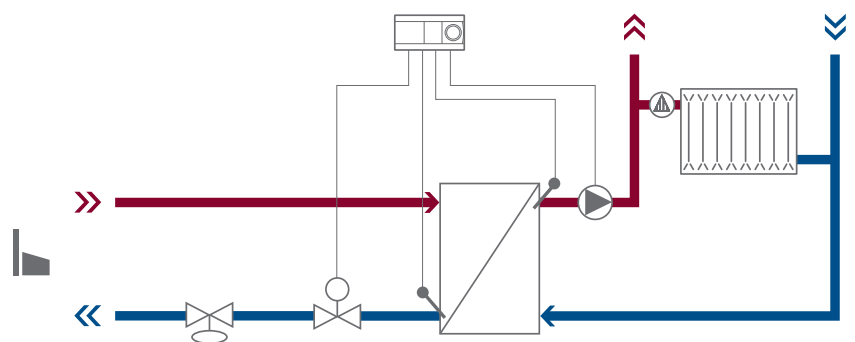

## Differential pressure controller

Differential pressure control in a DH network with HE and DHW.

The differential pressure controller maintains a constant differential pressure across the entire system. This provides better valve authority, and better DH network hydraulic balance is achieved. A dP controller is applied where differential pressure is variable.

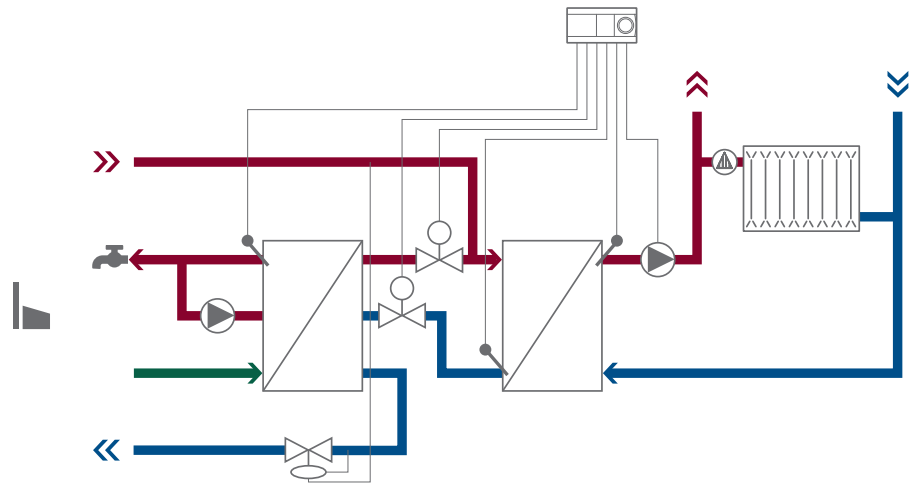

## Combined flow limiter and differential pressure controller

Combined flow limitation and differential pressure control in a DH network.

The function is in principle a dP controller with an integrated restrictor. It controls the differential pressure across a number of resistances (valves, heat exchangers, etc.) in which the adjustment restrictor is also included. A flow limiter should be installed in indirect applications, where the maximum flow is the basis for tariff allocation.

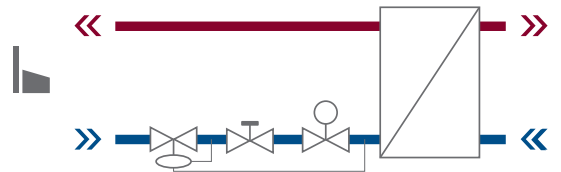

## Combined flow and differential pressure controller

Combined flow and differential pressure control in a directly connected DH heating system.

The dP controller maintains a constant dP across the system with the lower diaphragm. The upper diaphragm is for flow control. It keeps a constant dP across the adjustable maximum flow restriction, independent of the dP across the system. In this way, a maximum flow rate can be set. The combined flow and dP controller is recommended for direct systems, where the DH flow is a part of the tariff allocation and where the differential pressure is variable.

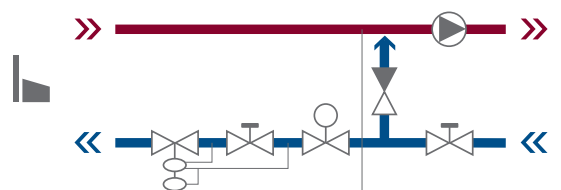

# Control functions

## Self-acting and electronic temperature control

There are different options available when it comes to controlling the secondary side outlet temperature. The choice of the right controlling method mainly depends on the DH network parameters. The more the supply temperature and the differential pressure varies, the more sophisticated a controller is needed to

optimally control the secondary side outlet temperature.

For small systems, self-acting controllers are typically applied. Electronic controllers are used for larger systems and if weather compensation is required.

### Thermostatic controlling (HE + DHW)

A thermostatic controller is used in DH systems with a moderate variation in the supply temperature and system differential pressure, and where a comfort standby control is requested. A minor "proportional" temperature deviation is to be expected for the HE and DHW temperature.

#### How it works

The purpose of the thermostatic controller is to maintain a constant temperature in the HE/DHW application.

When the controller registers a temperature change, it will either open or close the control valve, depending on whether the deviation (set temperature compared with the actual temperature) is positive or negative respectively.

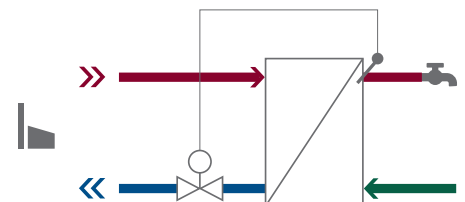

### Electronic controller (HE + DHW)

An electronic controller with weather compensation can be applied. Solutions vary from a simple user interface to more advanced selections of functions and options. These include standardized communication facilities and automatic control parameters for setting DHW and HE temperature control. The electronic controllers can be adapted to a multitude of different HE and DHW applications.

An electronic controller determines the flow rate through the system (e.g. heat exchanger) by operating a motorized control valve.

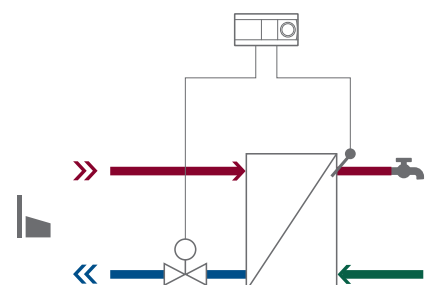

## Combined proportional flow controlling and dP controlling (DHW)

A combined proportional flow and dP controller is used in DH systems with a small variation in the supply temperature, but with varying or high system differential pressure. If no dP controller is installed, variations in differential pressure from the DH supply will result in large DHW temperature variations.

### How it works

The operating principle of the proportional flow and dP controller is to establish a proportional ratio between the secondary and primary flow. In this way, a constant DHW temperature is obtained if the primary supply temperature and the differential pressure are constant.

When the controller registers a flow on the secondary side, it opens the primary valve proportional to the secondary flow. The integrated dP controller maintains a constant differential pressure across the integrated control valve, which enables accurate flow control.

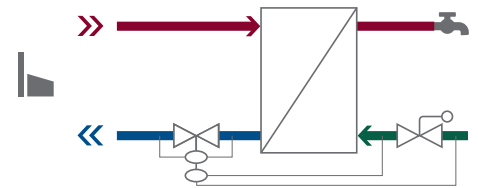

## Combined proportional flow, temperature and dP controlling (DHW)

A combined proportional flow, temperature and dP controller is used in DH systems with a variation in supply temperature and high and varying differential pressure.

### How it works

The principle of the proportional flow controller is to establish a proportional ratio between the secondary and primary flow. In this way, a constant DHW temperature is obtained if the primary supply temperature and the differential pressure is constant.

When the controller registers a flow on the secondary side, it opens the primary valve proportional to the secondary flow. The thermostatic controller limits the primary flow in cases where the flow contribution from the proportional controller is too high compared to the desired temperature set point. The dP controller maintains a constant differential pressure across the integrated control valve, which enables accurate flow control.

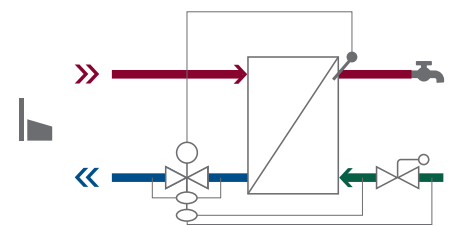

# Idling functions for DHW temperature control only

The general comfort requirement when preparing DHW in e.g. one-family houses or flats is that the desired temperature should be achieved without unnecessary delay. To achieve this, idling functions are used to keep the supply pipes and/or the heat exchanger warm during periods of no tapping. This is achieved by allowing a small flow to either bypass the heat exchanger or go through the heat exchanger during no tapping periods. Depending on the comfort level required, different idling methods can be used.

## a) Proportional controller

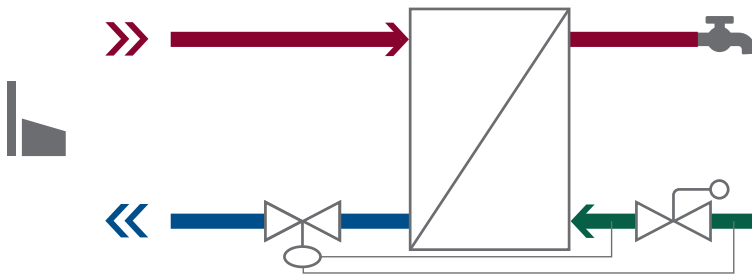

## b) Thermostatic controller

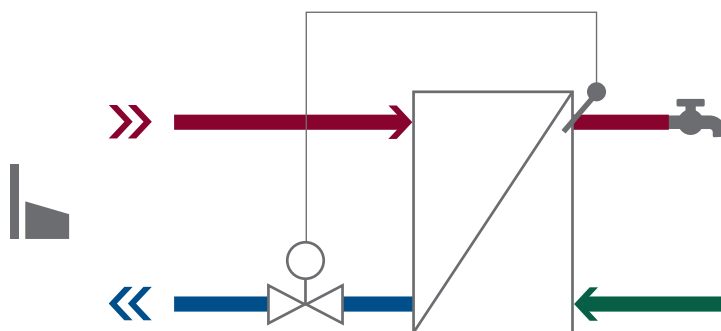

### c) Idling controller bypassing the supply line

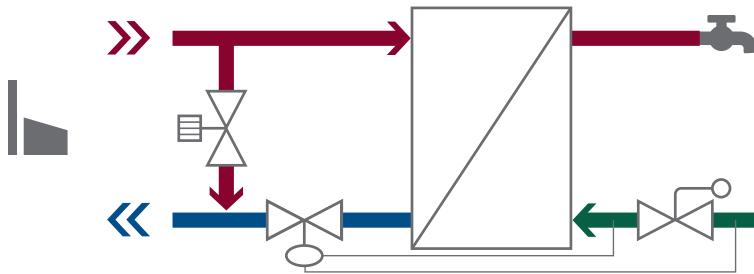

HEX cold and supply line warm during idling, temperature adjustable according to needs.

### d) Idling controller bypassing the control valve

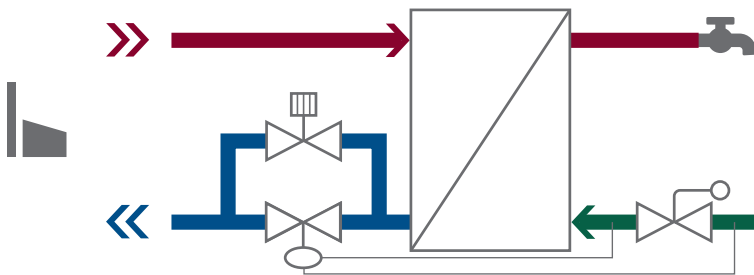

HEX and supply line warm during idling and temperature adjustable according to needs.

### e) Control valve with reduced temperature during idling

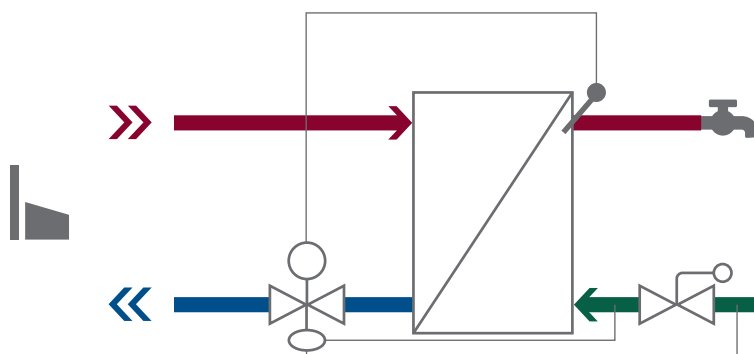

HEX and supply line warm during idling.

ECL Comfort 310

*Danfoss*

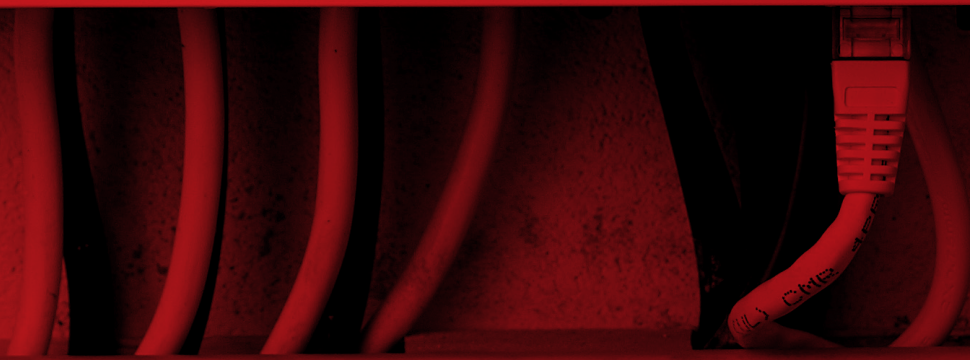
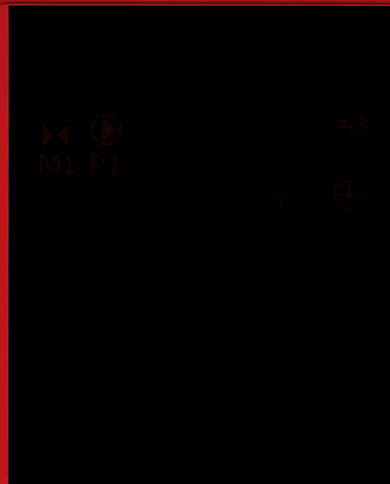

# Weather compensation

Weather is the main influencer on the heat demand of buildings. In cold periods, the building requires more heating and vice versa.

As the weather constantly changes, so does the heat load required to warm up a building. Compensating for weather influence is hence a rational and sound way to achieve energy savings.

The optimum heat supply to a building is when demand is met and nothing is in excess. An intelligent electronic controller for weather compensation in the heating system can proactively adjust the supply of heat to keep it at exactly that point by detecting changes in the weather conditions outside. On the other hand, a heating system without a weather compensator will only react to the current indoor temperature, and thus be prone to be in delay when changes occur outside. This negatively affects both user comfort and energy efficiency.

The weather compensator gets its signal from an outdoor temperature sensor placed on the shadow side of the building. The sensor registers the actual temperature and, if necessary, the electronic controller adjusts the heat supply (flow temperature) to reflect the new conditions. The controller will also adjust the heat supply to the radiators and ensure that room temperatures are kept constant. The user will in effect not even notice that the weather has changed outside and experience the same temperature and comfort at all times.

A report by COWI, a leading environmental science consulting group, puts the estimated energy savings with electronic weather compensators in one-family houses at 10% and in some cases as much as 40%. According to the report, one-family houses with large heat consumption gain particularly fast returns on investment after installing electronic weather compensators. Besides this, legislative regulations

for multi-family and commercial buildings prescribe weather compensation. In more and more countries, this also applies to one-family houses.

A heating system with electronic weather compensation can have additional control functions, such as:

- Flow and capacity limitation
- Temperature limitation possible for primary return temperature and/or secondary flow temperature.
- Safety function can be established
- Periodic system set-back function
- Possibility of data communication to e.g. a SCADA system or via a web portal
- Logging of energy consumption data

Systems with weather compensation are mainly used in radiator and floor heating systems.

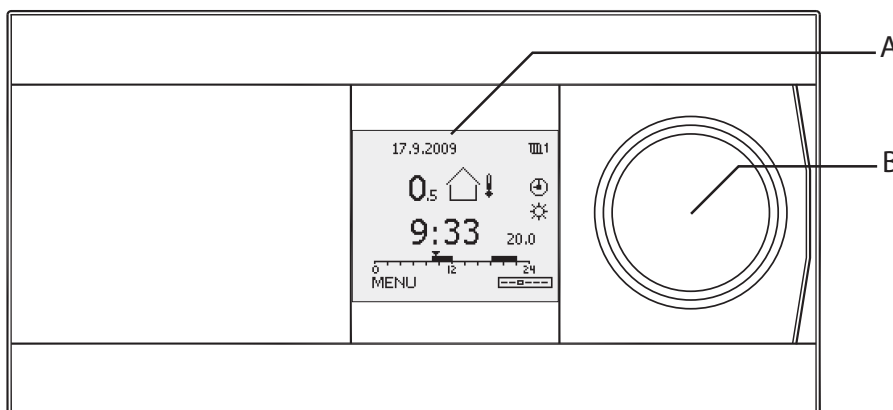

The graphic display (A) shows all temperature values as well as status information and is used for setting all control parameters.

Navigation, browsing and selecting the current item in the menus is done by means of the dial (multi functional knob (B)).

BRUGSVAND  
VARMT Cirk.

VARME  
fremlob

VARME  
tilbagelob

BRUGSVAND  
KOLDT



# Recommended applications

Recommended application design  
based on main district heating system types



# Guide to recommended applications and primary alternatives

## Application selection

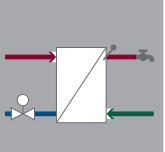
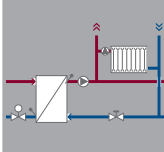
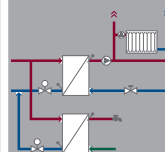
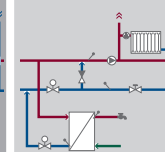
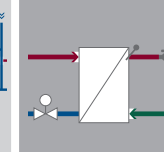
		One-family houses				
System characteristics	Low temperature system, $T \geq 60^\circ\text{C}$ (.) = PN10 bar only	•	•	•	(•)	•
	PN10 bar / $T \leq 90^\circ\text{C}$	•	•	•	•	•
	PN10 & PN16 bar / $T < 110^\circ\text{C}$	•	•	•		•
	PN16 bar / $T \geq 110^\circ\text{C}$	•	•	•		•
	PN25 bar / $T \geq 110^\circ\text{C}$					•
	Application category	DHW application	HE application	Combined HE and DHW applications		DHW application
Danfoss-recommended systems						
Application type	Instantaneous DHW application	Indirectly connected room heating application	Indirectly connected room heating and instantaneous domestic hot water application	Directly connected room heating with mixing loop and domestic hot water instantaneous application	Instantaneous DHW application	
System index	<b>0.1</b>	<b>1.0</b>	<b>1.1</b>	<b>2.1</b>	<b>0.1</b>	

When choosing the application, it is necessary to have information on the district heating network parameters to which the application is being connected. Given the network parameters, it is easy to see which applications are suitable for the district heating network from the Application Selection matrix.

As with the Application Type matrix, the Application Selection matrix also uses color-coding to show which solutions are recommended by Danfoss (green). The Application Selection matrix will act as a guide when choosing the best applications for the case at hand.

**For example:** The Danfoss recommended solution is application 1.1 for a single-family house application including DHW and heating, connected to a district heating network with supply temperature of 90°C and pressure level of PN16

Multi-family buildings							
Central systems					Flat station systems		
●	(●)	●	(●)		●	●	(●)
●	●	●	●		●	●	●
●		●		●	●	●	
●		●		●	●	●	
●		●		●	●	●	
HE application		Combined HE and DHW applications			Central supply to flat station (for HE and DHW via flat stations))		
Indirectly connected room heating application	Directly connected room heating application with mixing loop	Indirectly connected room heating and instantaneous domestic hot water application	Directly connected room heating with mixing loop and domestic hot water instantaneous application	Indirectly connected two-step HE and instantaneous DHW application	Indirectly connected application for supply of flat stations	Indirectly connected application with heat accumulator for supply of flat stations	Directly connected application with mixing loop for supply of flat stations
<b>1.0</b>	<b>2.0</b>	<b>1.1</b>	<b>2.1</b>	<b>1.1.1</b>	<b>1.F</b>	<b>2.F</b>	<b>3.F</b>

- Danfoss-recommended application
- Primary alternative to Danfoss-recommended application
- (●) PN10 bar only



Overview								
1	2	3	4	5	6	7	8	9
0.1	1.0	1.F	1.1	1.2	1.3	1.1.1	S.1.2	S.1.3
0.2	2.0	2.F	2.1	2.2	2.3	1.1.2		
0.3	3.0	3.F	3.1	3.2	3.3			

# 1. Domestic hot water applications

Most district heating networks are operated as closed loop systems, requiring an efficient method for the preparation of domestic hot water.

Today, domestic hot water is typically prepared either instantaneously by a heat exchanger close to the place of use, or with a reduced flow rate via a heat exchanger and stored in a tank ready for consumption.

- 0.1** Instantaneous DHW preparation by HEX
- 0.2** DHW preparation by HEX and storage charging tank
- 0.3** DHW preparation by cylinder

## Instantaneous DHW application

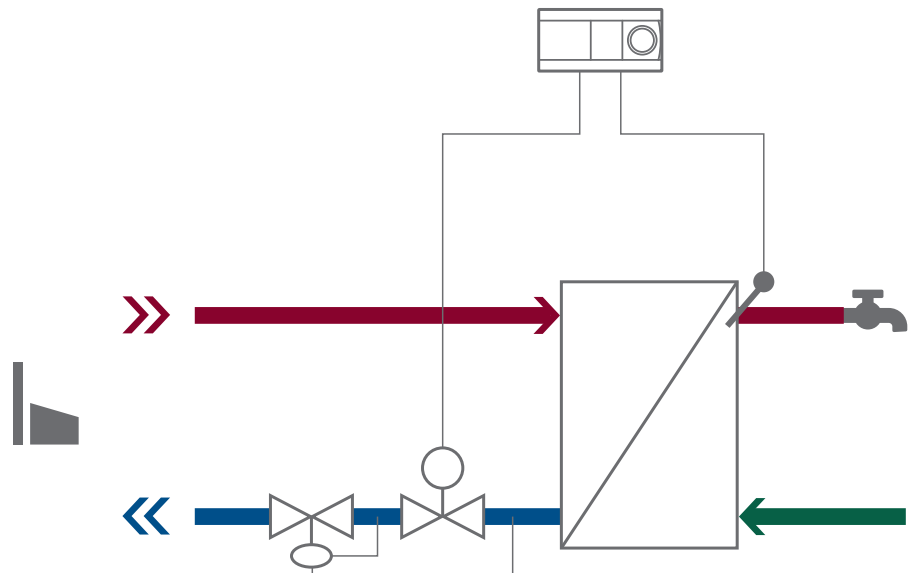

Instantaneous DHW application for connection to a DH system.

Instantaneous DHW preparation is normally used in combination with heating.

## How it works

DHW is instantaneously prepared with a heat exchanger. The heat exchanger physically separates the DHW and DH water.

The application can supply an unlimited amount of hot water at a constant temperature, which is prepared close to the tapping point when demanded and hence reduces the risk of legionella and other bacterial growth.

Depending on the desired DHW comfort level and the applied DHW controller, the heat exchanger and the supply line can be kept either hot or cold during idle time.

### Areas of use:

One-family houses  
Multi-family houses  
Commercial buildings

### DH system types:

PN10 & PN16 bar	$T \leq 60^{\circ}\text{C}$
PN10 bar	$T \leq 90^{\circ}\text{C}$
PN10 & PN16 bar	$T < 110^{\circ}\text{C}$
PN16 bar	$T \geq 110^{\circ}\text{C}$
PN25 bar	$T \geq 110^{\circ}\text{C}$

### Typical markets:

Almost all markets



## Control options

### Electronic control

Electronic control of DHW production can be configured with different functionalities.

### Self-acting control

Self-acting control can be achieved by thermostatic, flow, differential pressure controlling, or a combination of these control types.

In general, the electronic controller is applied for larger DHW systems, and self-acting controllers are applied for DHW systems in one-family houses or flats.

In systems with self-acting controls, a combination of flow and thermostatic controls are generally used.

### Idling DHW controlling

Depending on requirements, the heat exchanger and/or the supply line can be kept either warm or cold.



Istanbul, Turkey – Multi-family and commercial buildings with instantaneous DHW production.

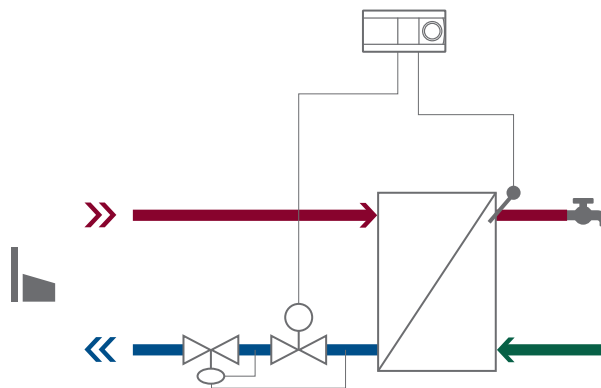



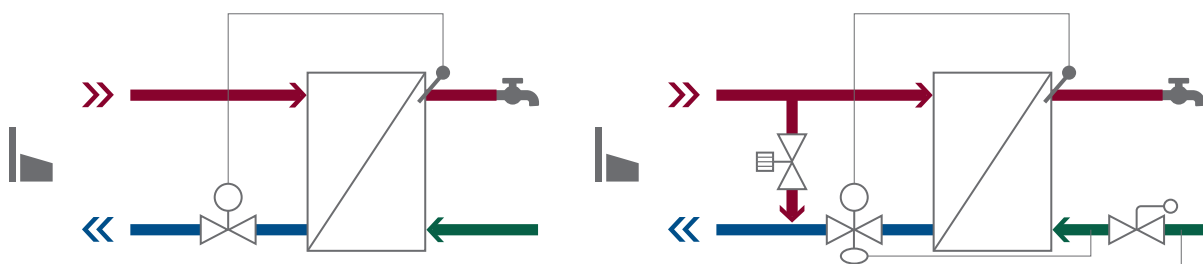







Example of electronic controlling

















Examples of self-acting controlling

# 1.0.1 Instantaneous DHW application

## Key application benefits

-  Low total system cost
-  Reduced design and planning times for consultants
-  Reduced maintenance cost
-  Compact and high-efficiency system
-  Low return temperature and low station heat loss
-  Suitable for low-temperature systems
-  Less space required in comparison with alternative applications
-  Unlimited amount of DHW, as it is prepared instantaneously on demand
-  Minimal risk of bacterial growth
-  Reduced hydronic load in network for group of consumers

## Recommendations

Application type		0.1 Instantaneous DHW application	0.2 DHW charging application	0.3 DHW cylinder application
Investment cost saving		●●●	●	●●
Installation time saving	 	●●●	●	●●
Space requirement saving	 	●●●	●	●
Service/maintenance saving	  	●●●	●	●
Energy efficiency performance	   	●●●	●●	●
System operation safety	 	●●●	●	●
User comfort		●●●	●●	●●



## Documented value

### Investment cost saving:

Application requires less equipment. In comparison to storage charging tank applications – including storage charging tank, pump and sensor – savings are estimated at 1,000 EUR. In multi-family buildings, savings will be higher. *Reference [2].*

### Space requirement savings:

Compact application requires less space. In comparison to storage charging tank or cylinder applications, space savings are estimated to be 0.24 m<sup>2</sup>. Given a value of 1,500 EUR/m<sup>2</sup>, savings are 360 EUR. In multi-family buildings, savings will be higher. *Reference [3].*

### Installation time saving:

Reduced installation time. In comparison to storage charging tank applications, reduced installation time is estimated to be 3 hours. Savings are estimated to be 150 EUR (60 EUR/hour). In multi-family buildings, savings will be higher. *Reference [3].*

### Service/maintenance savings:

Lower system maintenance cost. In comparison to storage charging tank and cylinder applications, maintenance time is estimated to be 2 hours less. Savings are estimated at 120 EUR/year (60 EUR/hour). In multi-family buildings, savings will be higher. *Reference [2].*

### Energy efficiency performance:

Reduced heat loss. In comparison to storage charging tank and cylinder applications, the heat loss is half. A 75 W reduction in heat loss is estimated to be 36 EUR/year (55 EUR/MWh). In multi-family buildings, savings will be higher. *Reference [3].*

### System operation safety:

With regard to bacterial growth, low system water volume (less than 3 litres from heat exchanger to tap) allows lower supply temperatures and DHW temperatures, which results in reduced heat loss in the DH network. *Reference [4].*



## Application limitations



- No DHW supply when DH supply is interrupted
- Design capacity (m<sup>3</sup>/h) on DH side is higher per consumer compared to storage charging tank and cylinder applications. For a group of consumers, typically 10-30 consumers, the design capacity is lower, however, for an application with instantaneous DHW production.



## DHW charging application

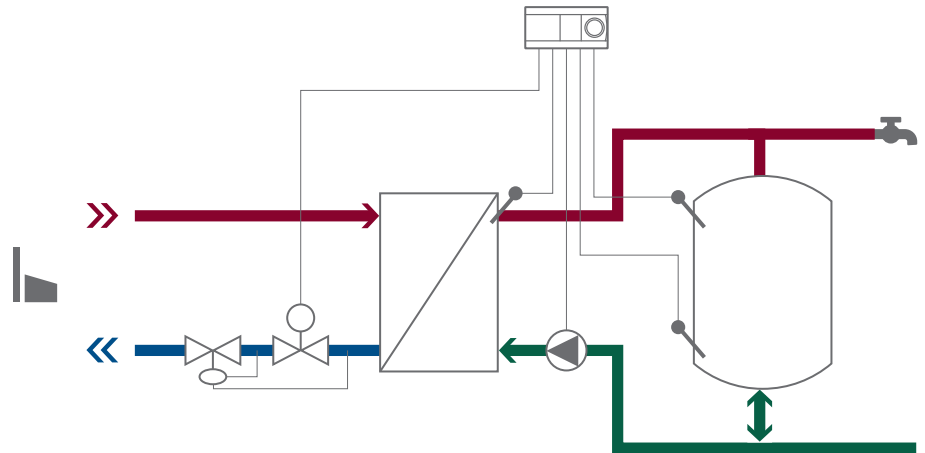

DHW charging tank application is suitable for central boiler applications, but applicable in connection with DH system.

DHW preparation is normally used in combination with heating.

### How it works

DHW is heated in a heat exchanger and let into a storage charging tank. Once the DHW capacity has been used, it needs time to be charged again. To maintain desired temperature during idling, the water in the storage charging tank is circulated through the heat exchanger.

The storage charging tank is especially suitable for special applications, e.g. commercial buildings where the peak load of DHW is high. In case DHW circulation is applied, the recirculation line should be placed into the tank

in a way that the stratification of the temperature is maintained. Hereby, a high return temperature can be avoided.

In the event of DH interruption for short periods of time, the storage charging tank can supply the remaining capacity of DHW. However, large-volume tanks increase the risk of bacterial growth. Local maintenance regulations should be observed concerning cleaning schedules.

#### Areas of use:

One-family houses  
Multi-family houses  
Commercial buildings

#### DH system types:

PN10 bar	$T \leq 90^{\circ}\text{C}$
PN10 & PN16 bar	$T < 110^{\circ}\text{C}$
PN16 bar	$T \geq 110^{\circ}\text{C}$
PN25 bar	$T \geq 110^{\circ}\text{C}$

#### Typical markets:

Central, South and Eastern Europe

### Application limitations

- Higher system price compared to an application with instantaneous DHW preparation due to cost of storage charging tank, pump and sensor
- Limited capacity
- Higher risk of bacterial growth compared to an application with instantaneous DHW preparation
- Large space requirement
- Large heat loss from the installation
- Not suitable for low-temperature systems
- Regular maintenance and cleaning required
- High primary return temperature compared to an application with instantaneous DHW preparation, but lower than cylinder application



## DHW cylinder application

The cylinder is used for one-family houses and smaller apartment buildings, but the charging capacity is limited compared to the storage charging tank solution.

DHW cylinder application is suitable for all boiler applications, but also applicable in connection with DH system.

DHW preparation is normally used in combination with heating.

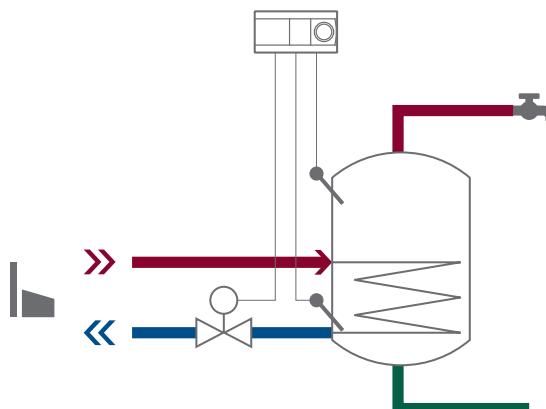

## How it works

DHW is heated in a cylinder by an internal heating coil. Once the DHW capacity has been used, it needs time to be charged again.

In case DHW circulation is applied, the recirculation line should be placed into the tank. It is important that the stratification of the temperature is maintained.

In the event of DH interruption for short periods of time, the cylinder can supply

the remaining capacity of DHW. However, large-volume cylinders increase the risk of bacterial growth. Local maintenance regulations should be observed concerning cleaning schedules.

### Areas of use:

One-family houses  
Multi-family houses

### DH system types:

PN10 bar	$T \leq 90^{\circ}\text{C}$
PN10 & PN16 bar	$T < 110^{\circ}\text{C}$
PN16 bar	$T \geq 110^{\circ}\text{C}$

### Typical markets:

Germany, Italy, Austria and UK

## Application limitations

- Higher system price compared to an application with instantaneous DHW preparation due to cost of cylinder and sensor
- Ineffective charging
- Limited capacity
- Higher risk of bacterial growth compared to an application with instantaneous DHW preparation
- Large space requirement
- Large heat loss from the installation
- Not suitable for low-temperature systems
- Regular maintenance and cleaning required
- High primary return temperature compared to an application with instantaneous DHW preparation and storage charging tank application





VARME  
tilbageløb

VARME  
tilbageløb

VARME  
tilbageløb

Overview								
1	2	3	4	5	6	7	8	9
0.1	1.0	1.F	1.1	1.2	1.3	1.1.1	S.1.2	S.1.3
0.2	2.0	2.F	2.1	2.2	2.3	1.1.2		
0.3	3.0	3.F	3.1	3.2	3.3			

## 2. Indirectly and directly connected room heating applications

The principles of room heating have not changed much over time – they are either indirectly or directly connected heating applications.

The indirect heating application controls the secondary side supply temperature and separates it from the DH network via a heat exchanger.

In a directly connected heating application, the secondary temperature can be controlled either via a mixing loop, or it can be equal to the supply temperature and thus uncontrolled.

- 1.0 Indirectly connected
- 2.0 Directly connected with mixing loop
- 3.0 Directly connected





## Control options

### Electronic control

An electronic controller is mainly used in radiator and floor heating systems. The electronic controller typically includes a weather compensator. The controller's primary function is the weather compensation of the supply temperature, periodic set-back (day/night) and pump control. Typical additional functions are max. and min. limitation of the supply and return temperature.

### Self-acting control

Self-acting control can be achieved by thermostatic, flow or differential pressure controlling, or a combination of these control types. A self-acting control solution is mainly used in small decentralized floor heating or AC systems.

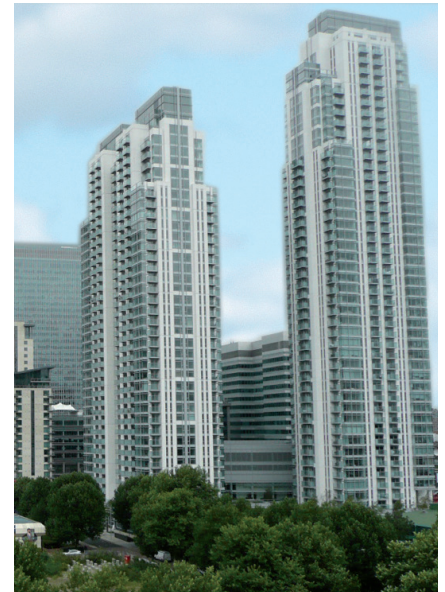



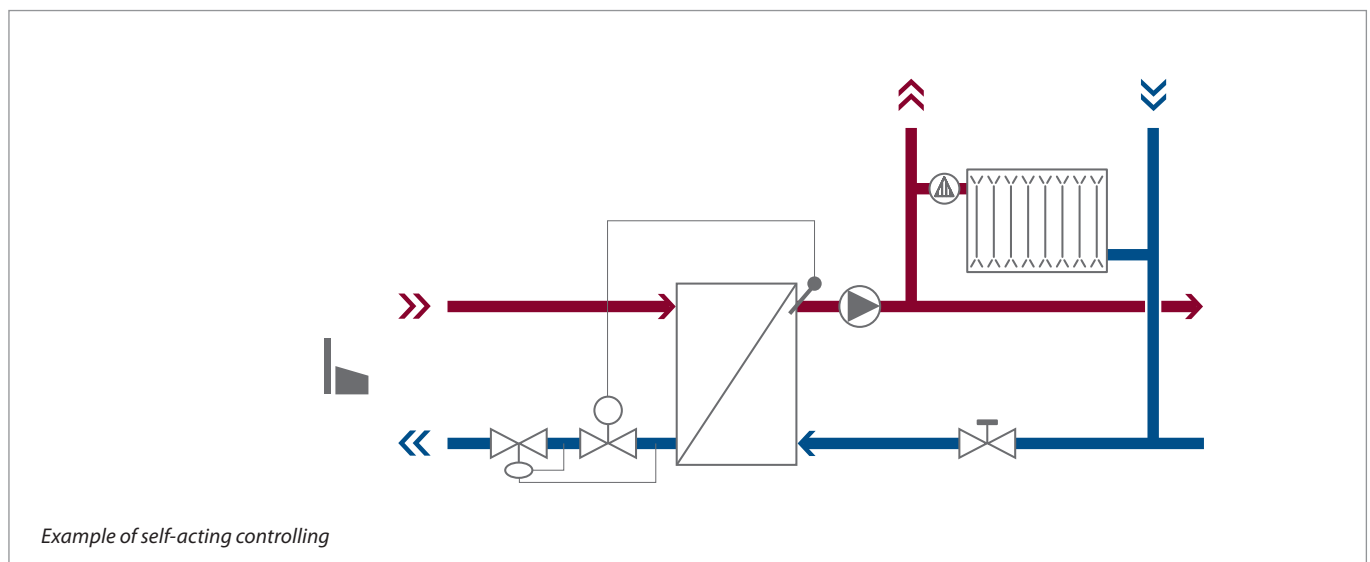
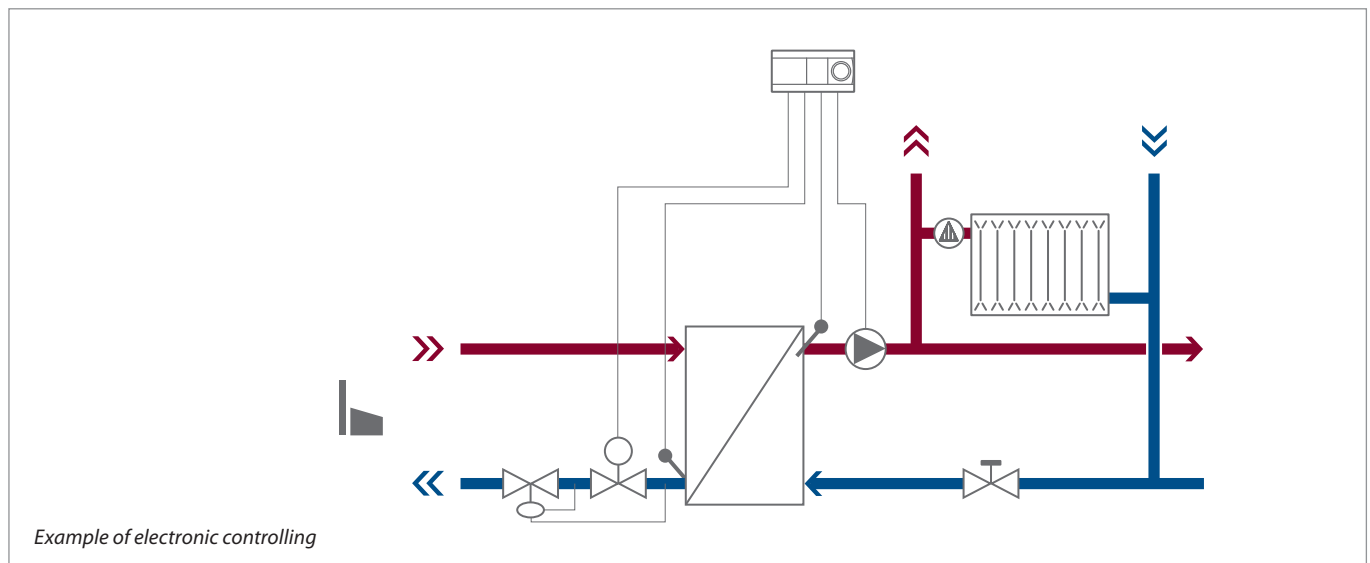





London, United Kingdom – Multi-family and commercial buildings with instantaneous DHW production.

















# 2.1.0 Indirectly connected room heating application

## Key application benefits

-  Suitable for low-temperature systems
-  Secondary temperature adapted to building heat load
-  Easy to establish high-temperature safety system
-  Reduced impact of leakage in building: leakage is restricted to the heating circuit
-  Increased energy-saving potential enabled by lower surface temperatures of radiators and more uniform room temperatures
-  Minimized risk of contamination of DH supply water, due to separation from the building system by a heat exchanger
-  High flexibility to the supply PN (nominal pressure) level in the DH network
-  Suitable for use with weather compensation control if electronic controller is applied

## Recommendations

Application type		1.0 Indirectly connected room heating application	2.0 Directly connected room heating applica- tion with mixing loop	3.0 Directly connected room heating application
Investment cost saving		●	●●	●●●
Installation time saving	 	●●	●●	●●●
Space requirement saving	 	●●	●●●	●●●
Service/maintenance saving	  	●●	●●	●●●
Energy efficiency performance	   	●●●	●●●	●
System operation safety	 	●●●	●	●
User comfort		●●●	●●●	●



## Documented value

### For the district heating network operator

**Energy-efficiency performance:**

Reduced heat loss. If electronic controllers with weather compensation are installed, every degree that the supply or return temperature can be lowered yields a saving of about 0.9% of the net heat loss in the DH network. Accumulated yearly savings of up to 6% have been documented in a DH system. *Reference [1].*



### For the building owner and end user

**Energy-efficiency performance:**

Energy savings. With electronic weather compensation of the heating system, energy savings of 11-15% or in some cases even higher have been documented for one-family houses. *Reference [1].*

**User comfort:**

Increased comfort due to lower surface temperature on radiators and constant room temperatures. *Reference [1].*

## Application limitations



**Self-acting control**

- No periodic set back
- High system heat loss when flow temperature is higher than actual demand
- No additional functions as pump control



## Directly connected room heating application with mixing loop

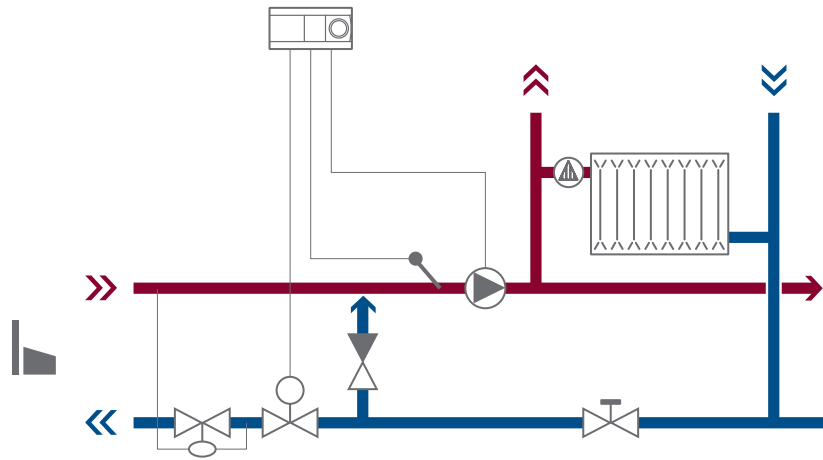

Directly connected room heating application with mixing loop for radiator, floor heating and AC systems.

### How it works

The application is directly connected to the DH network. Directly connected applications increase the risk of contamination of DH water and risk huge leakage in buildings.

The secondary flow temperature is adapted to the heat demand of the building by means of a mixing loop. To avoid 'back-flow', a check valve is mounted in the mixing loop. In addition, a differential pressure controller is applied for limitation of the differential pressure across the thermostatic radiator valves.

The application is typically electronically controlled. For a one-family house, it is possible to apply self-acting controls.

For comfort and energy saving reasons, electronic control with weather compensation is recommended in floor heating and radiator applications.

#### Areas of use:

One-family houses  
Multi-family houses  
Commercial buildings

#### DH system types:

PN10 bar	$T \leq 60^{\circ}\text{C}$
PN10 bar	$T \leq 90^{\circ}\text{C}$

#### Typical markets:

Denmark, Netherlands and general secondary systems

## Application limitations



- DH water is not separated from the house system
- If the primary water is not well treated, there is a risk of corrosion in the house system
- Risk of impurities from the house system to the DH water
- Potential risk of huge leakage and DH water draining from the house system
- If the maintenance of the secondary side is not clearly defined, this system is not recommended
- No clear definition of the capacity limitation when no flow controller is installed

#### Self-acting control

- No periodic set back
- High system heat loss when flow temperature is higher than actual demand
- No additional functions as pump control

## Directly connected room heating application

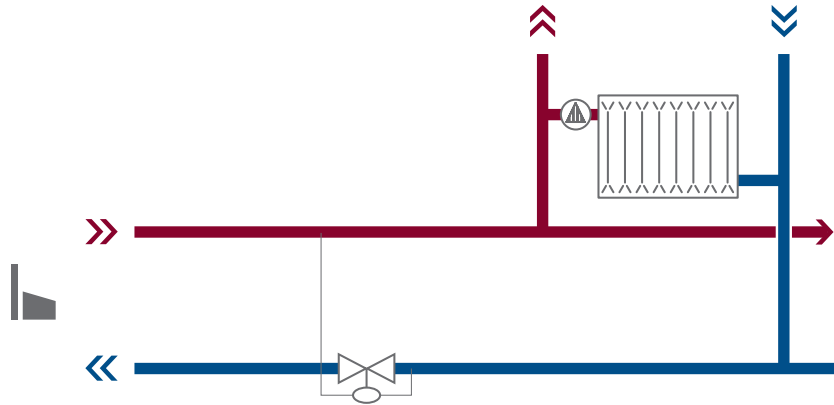

Directly connected room heating application for radiator, floor heating and AC systems.

### How it works

The application is directly connected to the DH network. Directly connected applications increase the risk of contamination of DH water and risk substantial leakage in buildings.

The HE temperature is flow-controlled by means of radiator thermostat, return temperature limiter or a room thermostat controlling a zone valve.

Additionally, a differential pressure controller is needed for limitation of

the differential pressure across the thermostats on the radiators.

The application is self-acting controlled.

#### Areas of use:

One-family houses

#### DH system types:

PN10 bar	$T \leq 60^{\circ}\text{C}$
PN10 bar	$T \leq 90^{\circ}\text{C}$

#### Typical markets:

Denmark, Netherlands and secondary systems



### Application limitations

- Return temperature limitation is only possible through self-acting return temperature limiter
- No possibility of changing flow temperatures for the building
- If the DH water is not well treated, there is a risk of corrosion in the building system
- Risk of impurities from the building system to the DH water
- Potential of huge leakage in the building
- If the maintenance of the secondary side is not clearly defined, this system is not recommended
- No clear definition of the capacity limitation when no flow controller is installed
- No periodic set back
- High system heat loss, when flow temperature is higher than actual demand

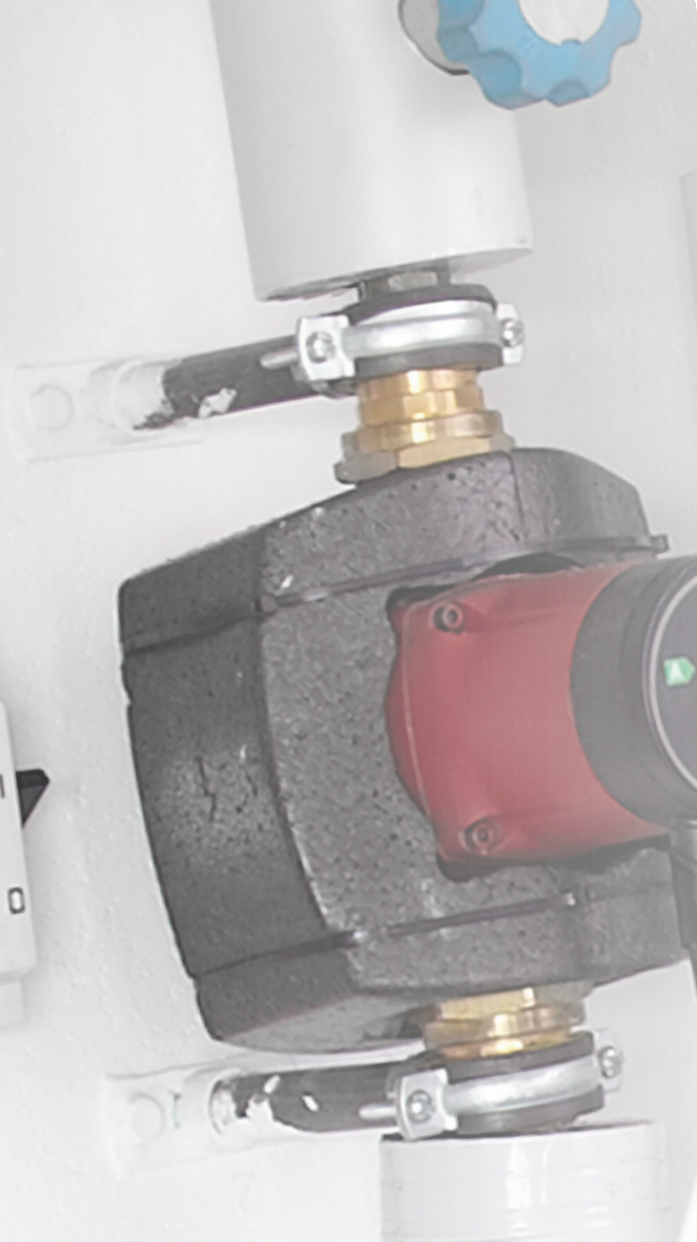

Overview								
1	2	3	4	5	6	7	8	9
0.1	1.0	1.F	1.1	1.2	1.3	1.1.1	S.1.2	S.1.3
0.2	2.0	2.F	2.1	2.2	2.3	1.1.2		
0.3	3.0	3.F	3.1	3.2	3.3			

### 3. Supply systems to flat stations applications

In multi-family houses, it is typical to have a district heating substation in the basement supplying the flats with hot water according to demand. For the supply of hot water, three applications are available:

1. A heat exchanger that controls the building side supply temperature and separates the building system from the DH network.
2. A storage tank charged by a heat exchanger separating the DH system and the building system and/or other available heat sources. The hot water in the tank is further used to supply the flats in the building.
3. A directly connected application that controls the building supply temperature via a mixing loop.

- 1.F** Indirectly connected
- 2.F** Indirectly connected with heat accumulator
- 3.F** Directly connected with mixing loop

## Decentralized heating with flat stations

A decentralized heating system comprises an installation with flat stations built into each apartment. Flat stations are supplied with hot water from a central energy source in the building. A flat station normally incorporates a compact plate heat exchanger, which produces instantaneous DHW on demand, and a differential pressure control valve to control the heating flow to the tenants' radiators or floor heating systems.

The essence of decentralized heating systems is to move certain processes from the central substation to the individual flats or apartments.

To ensure optimum system performance of the flat station, it is important to dimension the system and the central substation correctly.



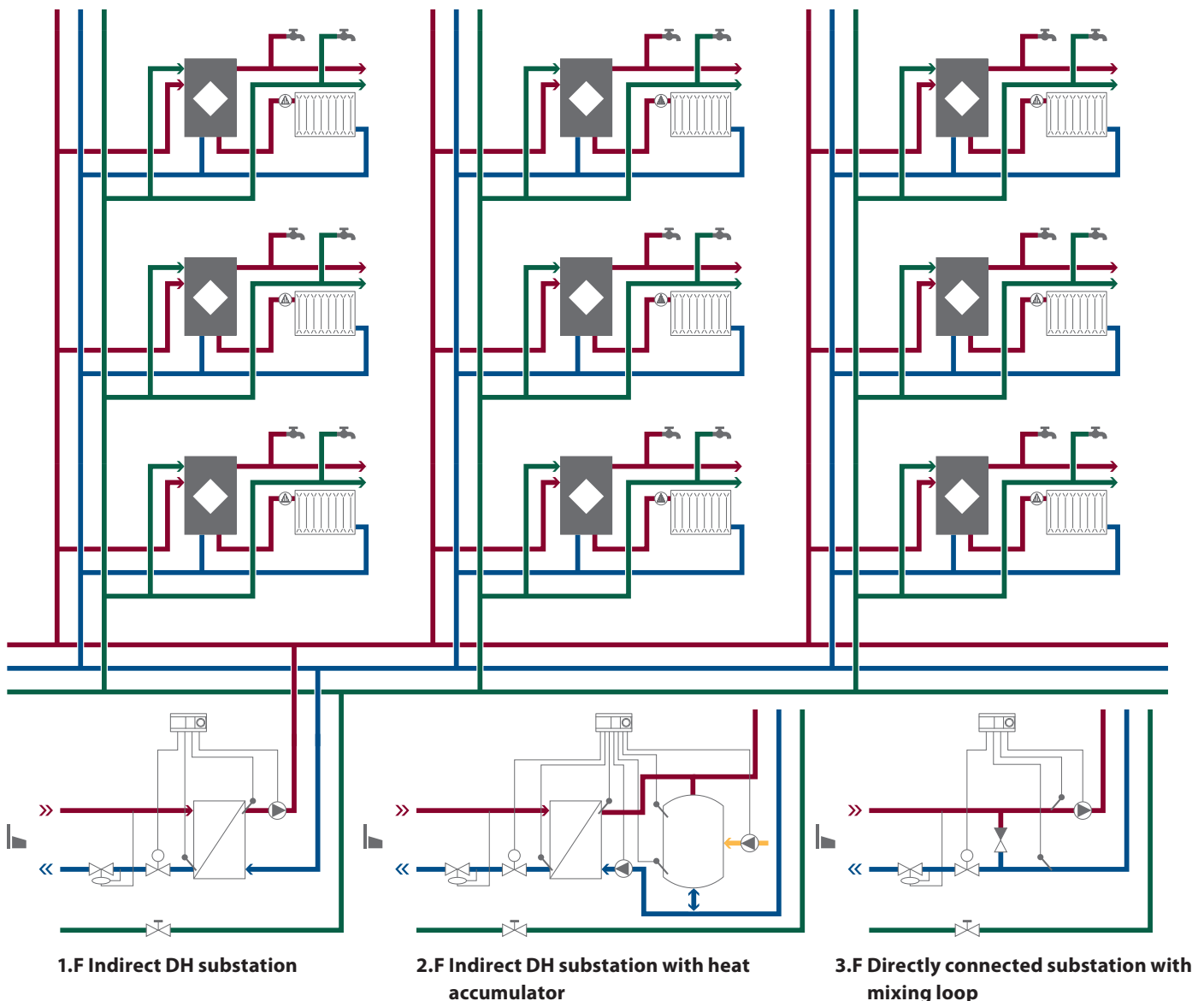



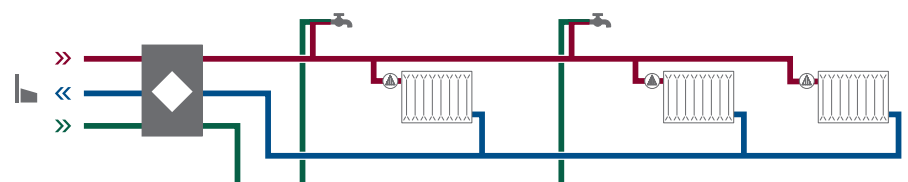



Decentralized systems can operate with all available energy sources. The most frequently used are either an indirect DH substation, any other directly connected substation, or boiler systems. All installations can be combined with local energy sources e.g. thermal solar heating.



In decentralized systems with flat stations, DHW is prepared close to the tap, which considerably reduces the risk of Legionella and other bacterial growth. Since the hot water for room heating passes through the flat station, only one energy meter is necessary to measure the energy consumption of the apartment.



## Key application benefits (compared to traditional systems)

-  Accurate individual energy metering
-  Reduced maintenance costs due to simple and reliable technology
-  Increased energy efficiency through improved system operation and low operational temperatures, suitable for low-temperature systems
-  Better hydronic balance in the system
-  Space-saving and easy to install
-  Compact and lightweight construction
-  User-friendly, simple and modern design
-  Low risk of bacterial growth
-  Individual setting of room temperature and independent instantaneous DHW preparation in sufficient quantities provides maximum comfort
-  Independence from energy source

---

## Documented value

### Investment cost savings:

Faster sales of flats. Decentralized system with flat station can save up to 735 EUR/flat through faster sales of flats compared to other heating solutions.

### Assumptions:

22 weeks to finish a 5 floor building compared to 10 weeks, if it is possible to dry and finish floor by floor (not waiting for the whole building to be finished). 70% of investment is covered by loan, 10% interest, 900 EUR/m<sup>2</sup> investment cost, 100 flats, average size of flat 70 m<sup>2</sup>.

### Energy-efficiency performance:

Reduced heat loss. Heat loss from circulation is 33% less in a decentralized system with flat station compared to 5-pipe system.

### Assumptions:

22 flats, pipe lengths of 242 m, heat loss coefficient 0.2 W/mK, supply temperatures 60°C, return line 5-pipe 55°C, return line flat station 30°C, surrounding temperature 20°C. *Reference [5].*

### Energy-efficiency performance:

Energy savings. Installation of a decentralized system with flat stations instead of a traditional system in a renovation project showed annual energy savings of 30% per flat. *Reference [6].*

# 3. 1.F Indirectly connected application for supply of flat stations

## Indirectly connected application for supply of flat stations

Indirectly connected system with heat exchanger for supply of hot water to flat stations in each apartment.

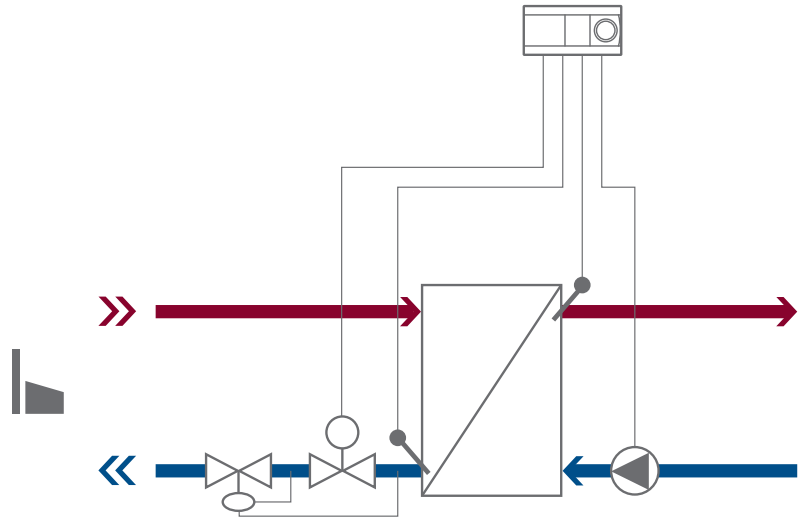

## How it works

The heat exchanger physically separates the DH network and the secondary side HE circuit.

For DHW preparation, the flow temperature from the heat exchanger should not be below 50-55°C.

The application can supply an unlimited amount of hot water at constant tempera-

ture with pressure conditions that suit the flat station applications being used.

For comfort and energy-saving reasons, electronic control with weather compensation is recommended in floor heating and radiator applications.

### Areas of use:

Multi-family houses

### DH system types:

PN10 & PN16 bar	$T \leq 60^{\circ}\text{C}$
PN10 bar	$T \leq 90^{\circ}\text{C}$
PN10 & PN16 bar	$T < 110^{\circ}\text{C}$
PN16 bar	$T \geq 110^{\circ}\text{C}$
PN25 bar	$T \geq 110^{\circ}\text{C}$

### Typical markets:

Scandinavia, Central and South Europe



Hafencity Hamburg, Germany  
– Multi-family and commercial buildings with district heating inside.







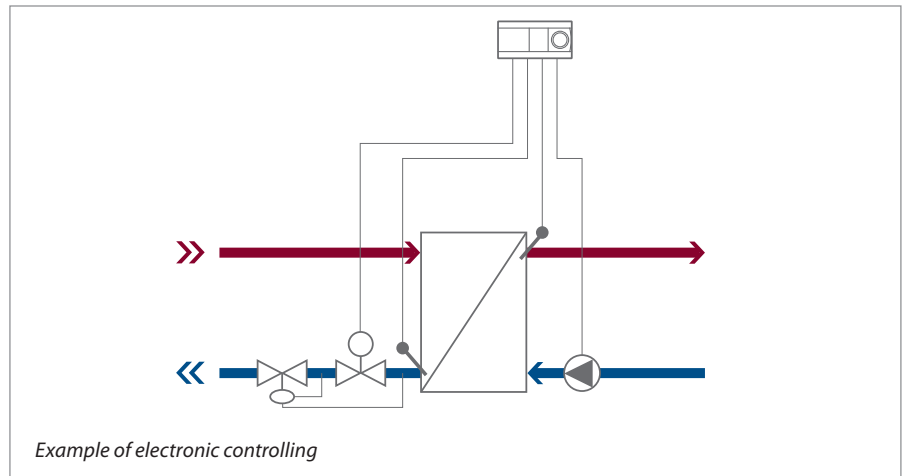

## Control options

### Electronic control

The electronic controller typically includes a weather compensator. The controller's primary function is the weather compensation of the supply temperature and pump control. Typical additional functions are max. and min. limitation of the supply and return temperature.



## Key application benefits

-  Low total cost of ownership of the system
-  Lower maintenance cost compared to systems with heat accumulator
-  Compact and high-efficiency heating system
-  Low return temperature and low heat loss from the central system and the piping
-  Suitable for low-temperature systems
-  Less space needed for installation compared to central applications with heat accumulator



## Application limitations

- Slower dynamic response to high DHW peak loads from the stations compared to heat accumulator
- If combined with local energy sources such as thermal solar heating, a heat accumulator must be added to the system

# 3.2.F Application

## Indirectly connected application with heat accumulator for supply of flat stations

Indirectly connected application with heat accumulator (charged by a heat exchanger) for supply of hot water to flat stations in each apartment.

Typical application for combination systems with thermal solar heating.

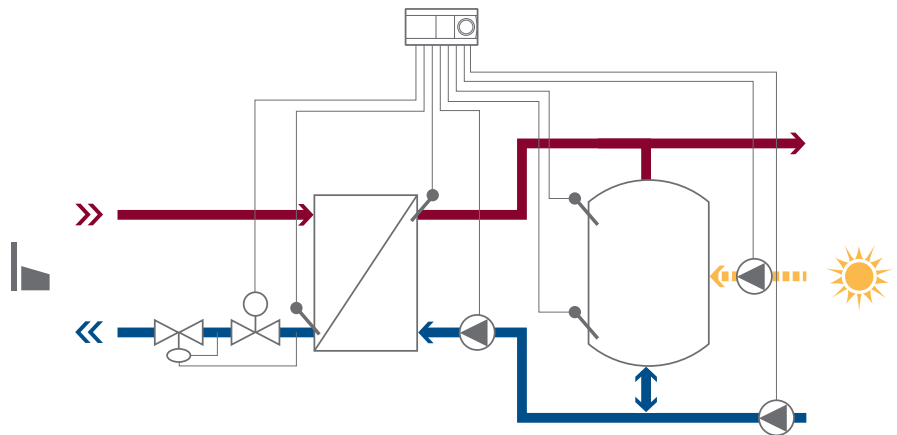

### How it works

The heat exchanger physically separates the DH network and the secondary site HE circuit and charges the heat accumulator. The system supplies hot water at constant temperature within pressure conditions that suit the flat station system being used.

For DHW preparation, the flow temperature from the heat accumulator should not be below 50-55°C.

To maintain desired temperature during idling, the water in the heat accumulator is circulated through the heat exchanger.

In the event of DH interruption for a short time, the heat accumulator can supply the remaining capacity to the flat stations.

For comfort and energy-saving reasons, electronic control with weather compensation is recommended in floor heating and radiator systems.

#### Areas of use:

Multi-family houses

#### DH system types:

PN10 & PN16 bar	$T \leq 60^{\circ}\text{C}$
PN10 bar	$T \leq 90^{\circ}\text{C}$
PN10 & PN16 bar	$T < 110^{\circ}\text{C}$
PN16 bar	$T \geq 110^{\circ}\text{C}$
PN25 bar	$T \geq 110^{\circ}\text{C}$

#### Typical markets:

Scandinavia, Central- and South Europe

Zagreb, Croatia  
– Multi-family and commercial buildings with district heating inside.

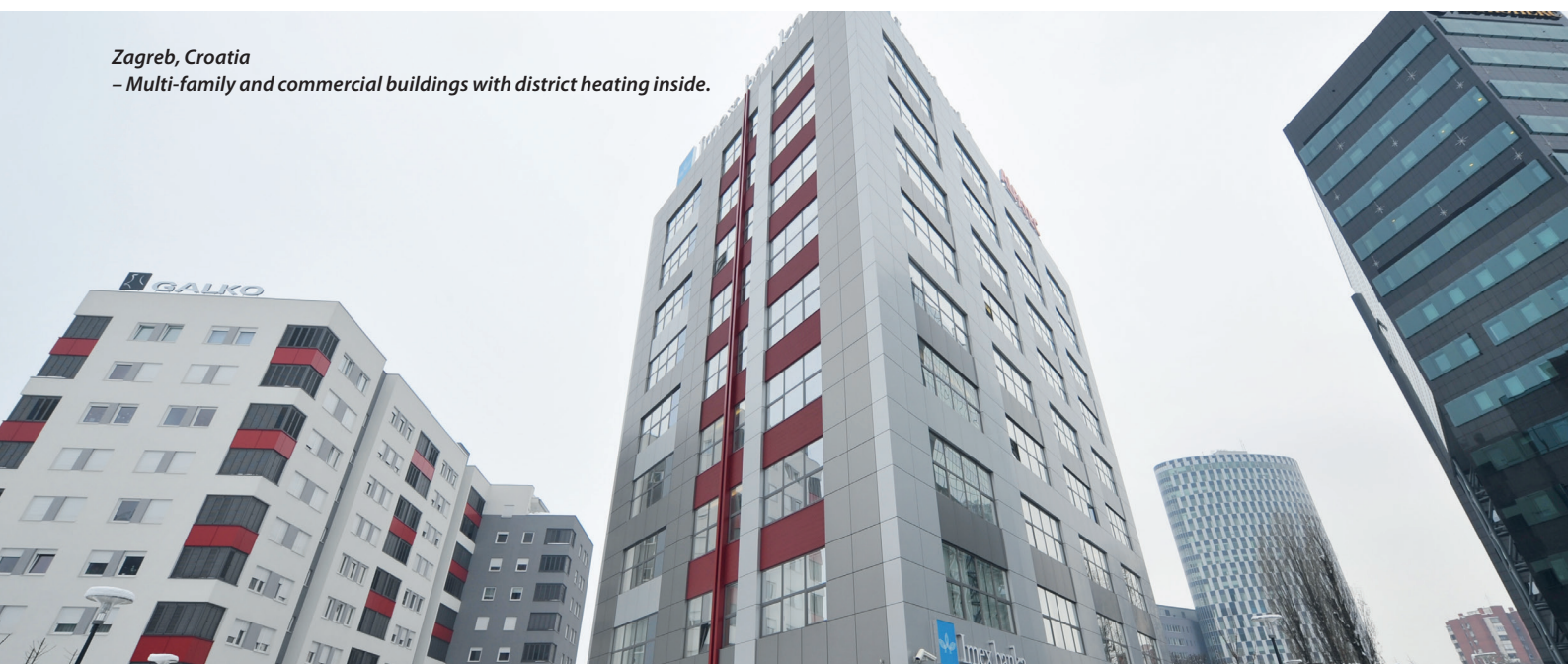



## Control options



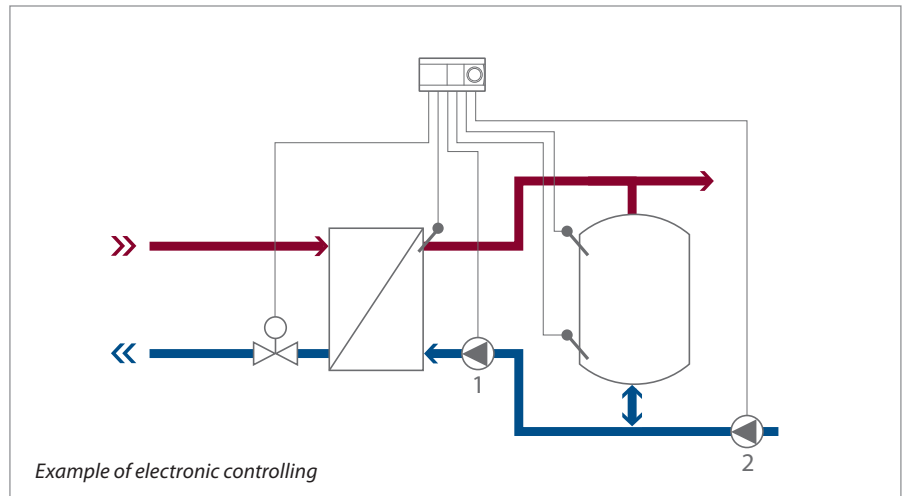

### Electronic control

Electronic control can be used with different functionalities.

In the figure, pump 1 circulates the charging water into the tank. The control valve on the primary side controls the charging temperature. Pump 2 provides the pump head for circulating the water through the building distribution system to the flat stations.



## Key application benefits

-  Reduces peak load of the DH supply by the heat accumulator
-  Optimum system design for low-volume installations at peak load
-  Superior supply response time in case of a sudden DHW peak load (compared to heat exchanger system and directly connected system)
-  Highly compatible in combination with local energy sources such as thermal solar heating



## Application limitations

- For large-volume installations with more than 30-50 flats, and where only DH supply is used, an application without heat accumulator is recommended.
- Immediate high supply of hot water to flat stations not possible when heat accumulator is empty.
- Greater heat loss from installation (station and heat accumulator)
- Larger space requirements compared to a pure heat exchanger application and directly connected application.
- Higher system price compared to a pure heat exchanger system, due to extra heat accumulator, pump and sensor

## Directly connected application with mixing loop for supply of flat stations

Directly connected application with mixing loop for supply of hot water to flat stations in each apartment.

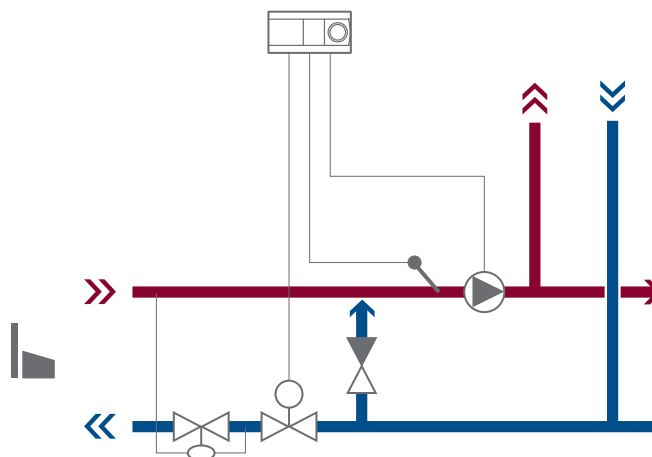

### How it works

The application is directly connected to the DH network.

For DHW preparation, the flow temperature from the mixing loop should not be below 50-55°C.

The secondary flow temperature is adapted to the heat demand of the building by means of a mixing loop. To avoid

'back-flow', a check valve is mounted in the mixing loop.

The application is typically electronically controlled.

For comfort and energy-saving reasons, electronic control with weather compensation is recommended in floor heating and radiator applications.

#### Areas of use:

Multi-family houses

#### DH system types:

PN10 & PN16 bar	T ≤ 60°C
PN10 bar	T ≤ 90°C

#### Typical markets:

Denmark and Holland

## Application limitations

- Slower dynamic response to high DHW peak loads from the flat stations compared to heat accumulator
- DH water is not separated from the house system
- If the DH water is not well treated, there is a risk of corrosion in the house system
- Risk of impurities from the house system to the DH water
- Potential risk of huge leakage and DH water draining from the house system
- If used in a combination with local energy sources such as solar thermal energy, a system with a heat accumulator is to be preferred.





saves **30%**  
on their heating bills

Electricity savings amount to €3,220 a year after the removal of the circulation pumps in each of the three apartment blocks.

Sønderborg, Denmark.

## Project example

# Lower return temperature Lower expenses

**A new heating and hot water system in 324 apartments, part of SAB cooperative housing association in the southern Danish town Sønderborg, has led to average annual energy savings of an estimated 30% per apartment.**

The result has mainly been achieved by installing a two-pipe system with Danfoss flat stations for district heating. In the original one-pipe system, installed in 1964, water was heated in central substations placed in a boiler room under the apartment block. Today, water is heated locally in each of the flat stations and residents can see exactly how much energy they use.

### **Awareness of consumption contributes to savings**

Prior to the modernization, none of the residents in the housing association were aware of their individual consumption. Today, each apartment has a meter for heat and domestic hot water consumption connected to the flat station. This has resulted in considerably higher awareness of consumption among the residents.

### **Meeting demand for individual metering**

Håndværkergården is responsible for installing the new heating and hot water system and, according to Project Manager Henning Christensen, alternative system solutions had been considered. However, in this project, flat stations turned out to be the best solution due to the demand for individual metering and payment for energy consumption.

### **Lower return temperature, lower expenses**

A major advantage of the two-pipe system is its contribution in reducing the temperature of the district heating water returned from the customers to the local Sønderborg District Heating Company. In winter time, the received temperature is around 80°C and the return temperature just 40°C. Before the modernization, the return temperature was 65°C.

### **FACTS:**

Sønderborg District Heating Company is a cooperative society owned by its 8,000 members. More than 90% of the heat distributed by the company is produced at the local combined heat and power plant. 65% of this is based on CO<sub>2</sub> neutral waste incineration.

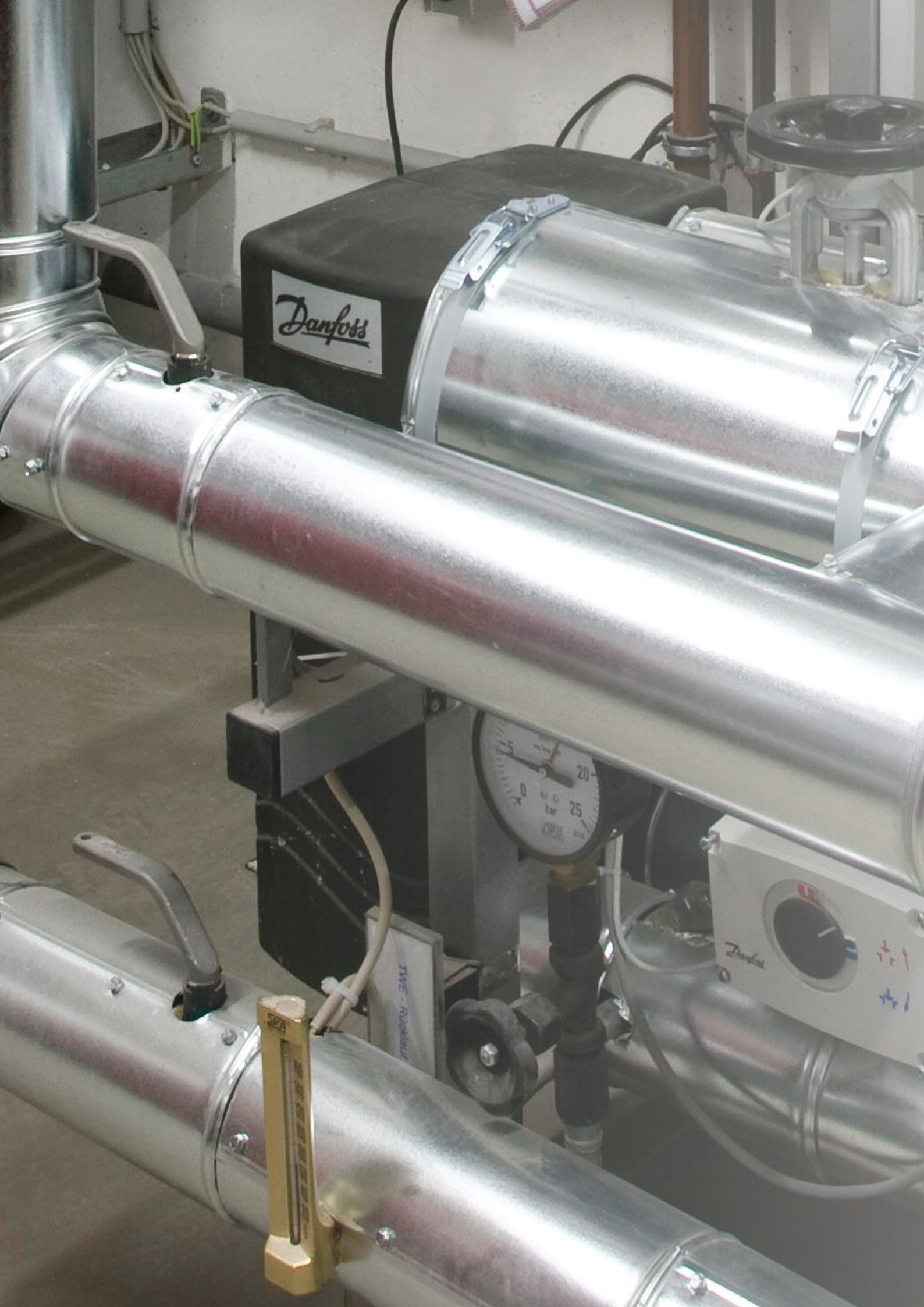

Danfoss

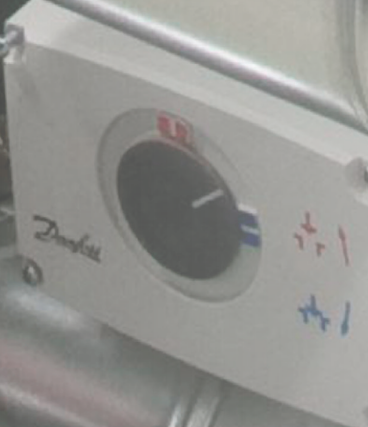

TWE - Ruckstuhl

Overview								
1	2	3	4	5	6	7	8	9
0.1	1.0	1.F	1.1	1.2	1.3	1.1.1	S.1.2	S.1.3
0.2	2.0	2.F	2.1	2.2	2.3	1.1.2		
0.3	3.0	3.F	3.1	3.2	3.3			

## 4. Directly and indirectly connected room heating and instantaneous domestic hot water heat exchanger applications

No matter size of the connected building, preparation of instantaneous hot water for room heating and domestic purposes is the essential function of most district heating systems.

The design of the application is flexible according to network characteristics and can be connected either indirectly, directly connected with or without mixing loop.

- 1.1 Indirectly connected HE and instantaneous DHW preparation with a heat exchanger
- 2.1 Directly connected HE with mixing loop and instantaneous DHW preparation with a heat exchanger
- 3.1 Directly connected HE and instantaneous DHW preparation with a heat exchanger

## Indirectly connected room heating and instantaneous domestic hot water application

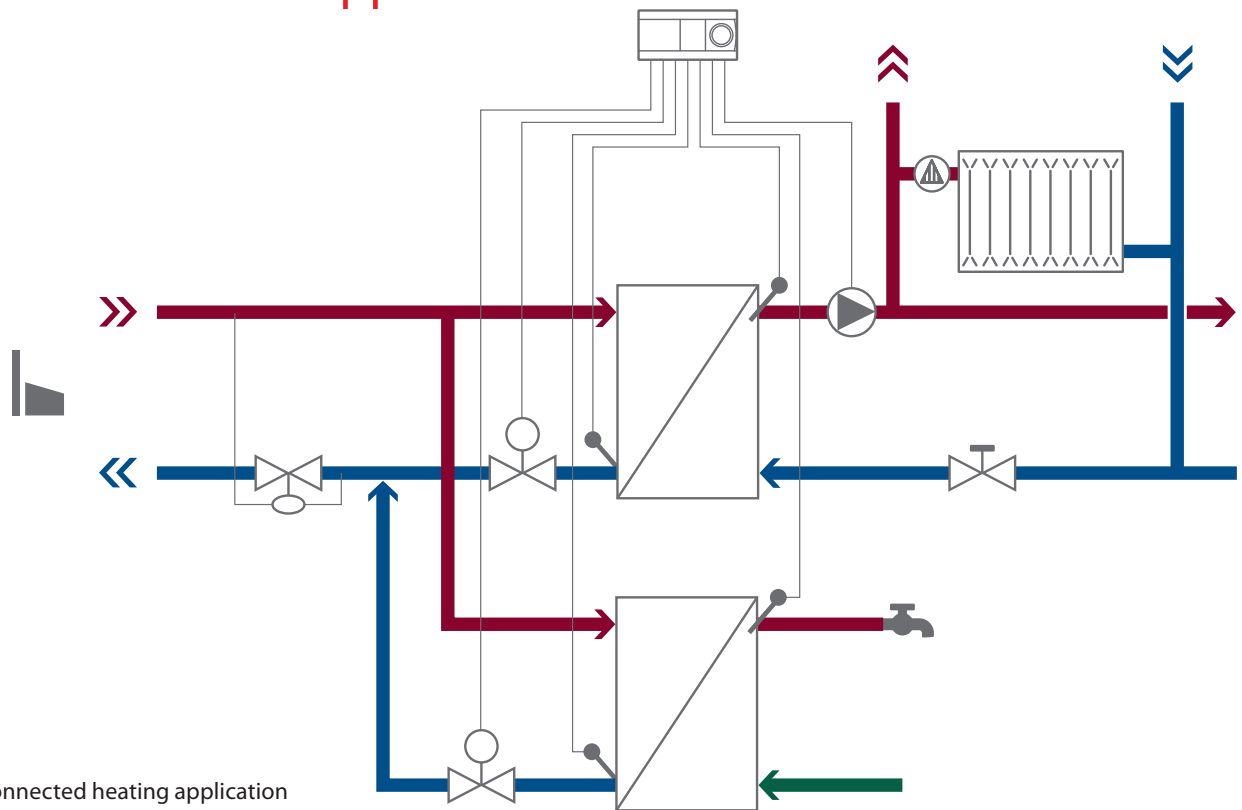

Indirectly connected heating application for radiator, floor heating and AC systems.

Instantaneous DHW preparation with heat exchanger.

## How it works

The heat exchanger physically separates the DH network and the HE circuit. The application minimizes the risk of contamination of DH water as well as the risks and consequences of leakage in apartments. The secondary flow temperature is adapted to the heat demand of the building.

DHW is instantaneously prepared with a heat exchanger. The heat exchanger physically separates the DHW and DH water.

The application can supply an unlimited amount of hot water at a constant temperature, which is prepared close to the tapping point when demanded, reducing the risk of legionella and other bacterial growth.

Depending on the desired DHW comfort level and the applied DHW controller, the heat exchanger and the supply line can be kept either hot or cold during idle time.

The heating system is typically controlled by an electronic weather compensator. The DHW system can be either electronically or self-acting controlled. For small systems, it is typically self-acting controlled.

### Areas of use:

One-family houses  
Multi-family houses  
Commercial buildings

### DH system types:

PN10 & PN16 bar	$T \leq 60^{\circ}\text{C}$
PN10 bar	$T \leq 90^{\circ}\text{C}$
PN10 & PN16 bar	$T < 110^{\circ}\text{C}$
PN16 bar	$T \geq 110^{\circ}\text{C}$
PN25 bar	$T \geq 110^{\circ}\text{C}$

### Typical markets:

Almost all markets



## Control options

### Electronic control

An electronic controller is mainly used in radiator and floor heating systems. The electronic controller typically includes a weather compensator. The controller's primary function is the weather compensation of the supply temperature, periodic set-back (day/night) and pump control. Typical additional functions are max. and min. limitation of the supply and return temperature.

### Self-acting control

For small DHW systems, self-acting control can be achieved by thermostatic, flow, differential pressure controlling, or a combination of these control types.

For HE, self-acting control can be achieved by thermostatic, flow, differential pressure controlling, or a combination of these control types.

A self-acting control solution is mainly used in small decentralized floor heating or AC systems.

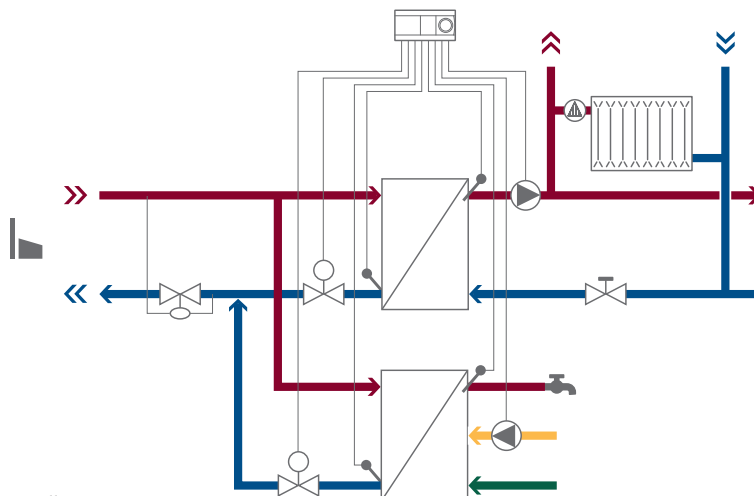



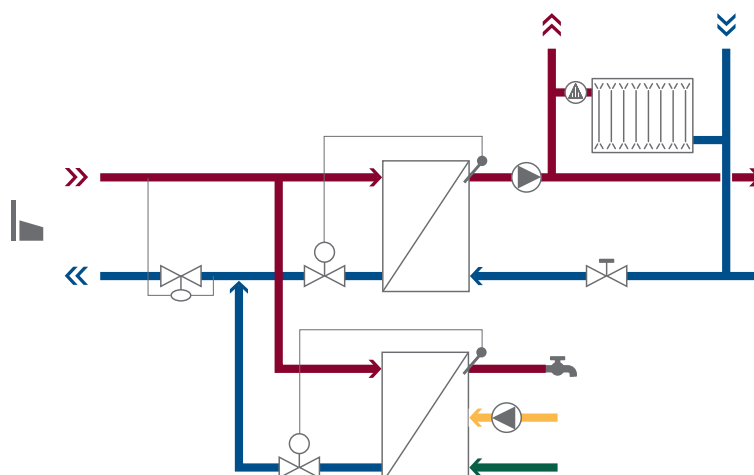





Example of electronic controlling













Example of self-acting controlling

## Key application benefits































### Heating (HE) circuit

-  Suitable for low-temperature systems
-  Secondary temperature adapted to building heat load
-  Easy to establish high-temperature safety system
-  Reduced impact of leakage in building: leakage is restricted to the heating circuit
-  Increased energy-saving potential enabled by lower surface temperatures of radiators and more uniform room temperatures
-  Minimized risk of contamination of DH supply water, due to separation from the building system by a heat exchanger
-  High flexibility to the supply PN (nominal pressure) level in the DH network
-  Suitable for use with weather compensation control, if electronic controller is applied

### Domestic hot water (DHW) circuit

-  Low DHW system cost
-  Reduced design and planning time for consultants
-  Reduced maintenance cost
-  Compact and highly efficient system
-  Low return temperature and low station heat loss
-  Suitable for low-temperature systems
-  Less space required in comparison with alternative applications
-  Unlimited amount of DHW, as it is prepared instantaneously on demand
-  Minimum risk of bacterial growth
-  Reduced hydronic load in network for group of consumers

# Recommendations

Domestic hot water and room heating applications				
		1.1 Indirectly connected room heating and instantaneous domestic hot water application	2.1 Directly connected room heating with mixing loop and domestic hot water instantaneous application	3.1 Directly connected HE and instantaneous DHW application
Heating		Indirectly connected room heating application	Directly connected room heating application with mixing loop	Directly connected room heating application
Investment cost saving		●	●●	●●●
Installation time saving	 	●●	●●	●●●
Space requirement saving	 	●●	●●●	●●●
Service/maintenance saving	  	●●	●●	●●●
Energy efficiency performance	   	●●●	●●●	●
System operation safety	 	●●●	●	●
User comfort		●●●	●●●	●
Domestic hot water		Instantaneous domestic hot water application	Domestic hot water charging application	Domestic hot water cylinder application
Investment cost saving		●●●	●	●●
Installation time saving	 	●●●	●	●●
Space requirement saving	 	●●●	●	●
Service/maintenance saving	  	●●●	●	●
Energy efficiency performance	   	●●●	●●	●
System operation safety	 	●●●	●	●
User comfort		●●●	●●	●●

# 4.1.1 Indirectly connected room heating and instantaneous domestic hot water application

## Documented value

### Heating (HE) circuit

#### For the district heating network operator

##### Energy-efficiency performance:

Reduced heat loss. If electronic controllers with weather compensation are installed, every degree that the supply or return temperature can be lowered yields a saving of about 0.9% of the net heat loss in the DH network. Accumulated yearly savings of up to 6% have been documented in a DH system. *Reference [1].*



#### For the building owner and end user

##### Energy-efficiency performance:

Energy savings. With electronic weather compensation of the heating system, energy savings of 11-15% or in some cases even higher have been documented for one-family houses. *Reference [1].*

##### User comfort:

Increased comfort due to lower surface temperature on radiators and constant room temperatures. *Reference [1].*

### Domestic hot water (DHW) circuit

##### Investment cost saving:

Application requires less equipment. In comparison to storage charging tank applications – including storage charging tank, pump and sensor – savings are estimated at 1,000 EUR. In multi-family buildings, savings will be higher. *Reference [2].*

##### Space requirement savings:

Compact applications requires less space. In comparison to storage charging tank or cylinder applications, space savings are estimated 0.24 m<sup>2</sup>. Given a value of 1,500 EUR/m<sup>2</sup>, savings are 360 EUR. In multi-family buildings, savings will be higher. *Reference [3].*

##### Installation time saving:

Reduced installation time. In comparison to storage charging tank applications, reduced installation time is estimated at 3 hours. Savings are estimated at 150 EUR (60 EUR/hour). In multi-family buildings, savings will be higher. *Reference [3].*

##### Service/maintenance savings:

Lower system maintenance cost. In comparison to storage charging tank and cylinder applications, maintenance time is estimated at 2 hours less. Savings are estimated at 120 EUR/year (60 EUR/hour). In multi-family buildings, savings will be higher. *Reference [2].*

##### Energy efficiency performance:

Reduced heat loss. In comparison to storage charging tank and cylinder applications, the heat loss is half. A 75 W reduction in heat loss is estimated at 36 EUR/year (55 EUR/MWh). In multi-family buildings, savings will be higher. *Reference [3].*

##### System operation safety:

With regard to bacterial growth, low system water volume (less than 3 litres from heat exchanger to tap) allows lower supply temperatures and DHW temperatures, resulting in reduced heat loss in the DH network. *Reference [4].*



Salzburg, Austria – Multi-family buildings with district heating inside.



## Application limitation

### Self-acting control

- No periodic set back
- High system heat loss when flow temperature is higher than actual demand
- No additional functions as pump control

### Heating (HE) circuit

- Expensive heating system
- The secondary system needs an expansion vessel

### Domestic hot water (DHW) circuit

- No DHW supply when DH supply is interrupted
- Design capacity (m<sup>3</sup>/h) on DH side is higher per consumer compared to storage charging tank and cylinder applications. For a group of consumers, typically 10-30 consumers, the design capacity is however lower for an application with instantaneous DHW production.



## Directly connected room heating with mixing loop and domestic hot water instantaneous application

Directly connected heating application with mixing loop for radiator, floor heating and AC systems.

Instantaneous DHW preparation with heat exchanger.

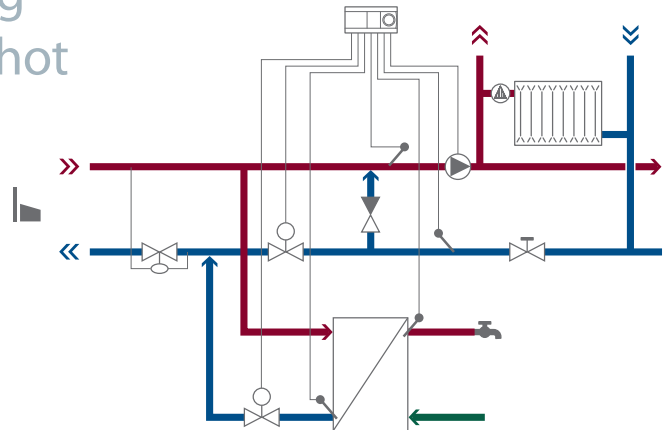

### How it works

The HE system is directly connected to the DH network with a mixing loop. Directly connected applications increase the risk of contamination of DH water and risk huge leakage in buildings.

The secondary flow temperature is adapted to the heat demand of the building by means of a mixing loop. To avoid 'back-flow', a check valve is mounted in the mixing loop. In addition, a differential pressure controller is applied for limitation of the differential pressure across the thermostatic radiator valves.

DHW is instantaneously prepared with a heat exchanger. The heat exchanger physically separates the DHW and DH water.

The application can supply unlimited amounts of hot water at a constant temperature. This is prepared close to the tapping point when demanded, reducing the risk of legionella and other bacterial growth.

Depending on the desired DHW comfort level and the applied DHW controller, the heat exchanger and the supply line can be kept either hot or cold during idle time.

The heating system is typically controlled by an electronic weather compensator. The DHW system can be either electronically or self-acting controlled. For small systems, it is typically self-acting controlled.

#### Areas of use:

One-family houses  
Multi-family houses  
Commercial buildings

#### DH system types:

PN10 bar	$T \leq 60^{\circ}\text{C}$
PN10 bar	$T \leq 90^{\circ}\text{C}$

#### Typical markets:

Denmark, Netherlands and in secondary systems

## Application limitations

### Self-acting control

- No periodic set back
- High system heat loss when flow temperature is higher than actual demand
- No additional functions as pump control

### Heating (HE) circuit

- DH water is not separated from the house system
- If the primary water is not well treated, there is a risk of corrosion in the house system
- Risk of impurities from the house system to the DH water
- Potential risk of huge leakage and DH water draining from the house system
- If the maintenance of the secondary side is not clearly defined, this system is not recommended
- No clear definition of capacity limitation, where no flow controller is installed

### Domestic hot water (DHW) circuit

- No DHW supply when DH supply is interrupted
- Design capacity ( $\text{m}^3/\text{h}$ ) on DH side is higher per consumer compared to storage charging tank and cylinder applications. For a group of consumers, typically 10-30 consumers, the design capacity is however lower for an application with instantaneous DHW production.



## Directly connected HE and instantaneous DHW application

Directly connected heating application for radiator, floor heating and AC systems.

Instantaneous DHW preparation with heat exchanger.

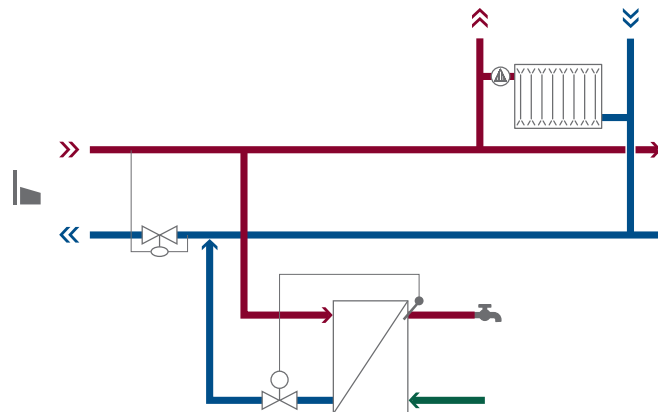

### How it works

The HE system is directly connected to the DH network. Directly connected systems increase the risk of contamination of DH water and risk huge leakage in buildings.

The HE temperature is flow-controlled by means of radiator thermostat, return temperature limiter or a room thermostat controlling a zone valve. In addition, a differential pressure controller is needed for limitation of the differential pressure across the thermostats on the radiators.

DHW is instantaneously prepared with a heat exchanger. The heat exchanger physically separates the DHW and DH

water. The application can supply unlimited amounts of hot water at constant temperature. This is prepared close to the tapping point when demanded, reducing the risk of legionella and other bacterial growth.

Depending on the desired DHW comfort level and the applied DHW controller, the heat exchanger and the supply line can be kept either hot or cold during idle time.

The HE system can only be self-acting controlled. The DHW system is typically self-acting, but can also be electronically controlled.

#### Areas of use:

One-family houses

#### DH system types:

PN10 bar	T ≤ 60°C
PN10 bar	T ≤ 90°C

#### Typical markets:

Denmark, Netherlands and in secondary systems

## Application limitations

### Heating (HE) circuit

- Return temperature limitation is only possible through self-acting return temperature limiter
- No possibility of changing flow temperatures for the building
- If the DH water is not well treated, there is a risk of corrosion in the building system
- Risk of impurities from the building system to the DH water
- Potential of huge leakage in the building
- If the maintenance of the secondary side is not clearly defined, this system is not recommended
- No clear definition of capacity limitation, where no flow controller is installed
- No periodic set back
- High system heat loss when flow temperature is higher than actual demand

### Domestic hot water (DHW) circuit

- No DHW supply in case of DH supply interruption
- Design capacity (m<sup>3</sup>/h) on DH side is higher per consumer compared to storage charging tank and cylinder applications. For a group of consumers, typically 10-30 consumers, the design capacity is however lower for an application with instantaneous DHW production.



FLØYERSEN  
TLF. 86 62 21 18



ECL COMFORT 310 PORTAL

Home ECL Settings Graph Meters Alarms My account Log out

6430 Nordborg - Nordborg

Choose ECL

6430 Nordborg - Nordborg

Common

Common holiday

Program 1

Scheduled operation

Start

Start

Save

Primary settings

Flow temperature

Room limit

Return limit

Flow / power limit

Optimization

Control par.

Application

Schedule

Circuit 2 holiday

Program 2

Scheduled operation

Start

Start

Save

Program 3

Scheduled operation

Start

Start

Save

Program 4

Scheduled operation

Start

Start

Save

Program 5

Constant setback temperature

Start

Start

Save

Copyright Danfoss

Terms of use | Privacy policy | General information



Overview								
1	2	3	4	5	6	7	8	9
0.1	1.0	1.F	1.1	1.2	1.3	1.1.1	S.1.2	S.1.3
0.2	2.0	2.F	2.1	2.2	2.3	1.1.2		
0.3	3.0	3.F	3.1	3.2	3.3			

## 5. Directly and indirectly connected room heating and domestic hot water charging tank applications

Preparation of domestic hot water via a storage charging tank and room heating applications can be combined either indirectly connected to the DH network, or alternatively as directly connected with or without mixing loop.

- 1.2** Indirectly connected HE and DHW preparation with a heat exchanger and storage charging tank
- 2.2** Directly connected HE with mixing loop and DHW preparation with a heat exchanger and storage charging tank
- 3.2** Directly connected HE and DHW preparation with a heat exchanger and storage charging tank



## Indirectly connected HE with DHW charging application

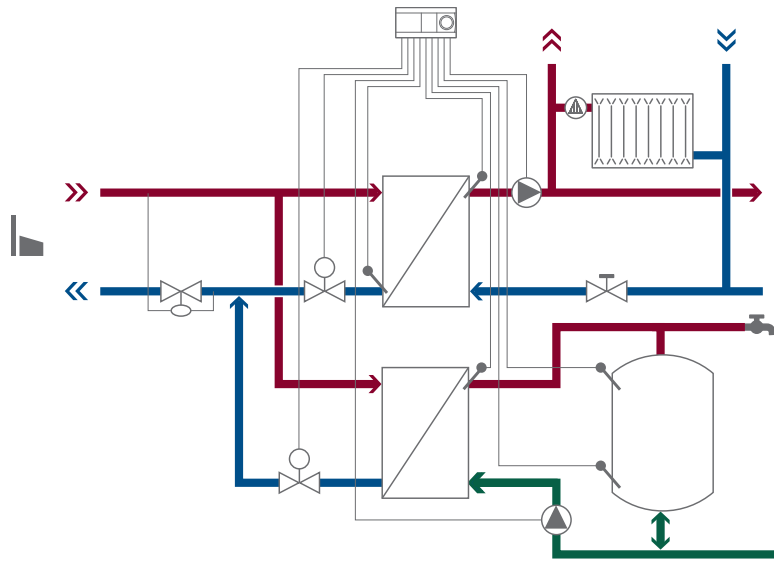

Indirectly connected heating application for radiator, floor heating and AC systems.

DHW charging tank application suitable for central boiler applications, but applicable in connection with DH.

### How it works

The heat exchanger physically separates the DH network and the HE circuit. The application minimizes the risk of contamination of DH water as well as the risks and consequences of leakage in apartments.

The secondary flow temperature is adapted to the heat demand of the building. DHW is heated in a heat exchanger and let into a storage charging tank. Once the DHW capacity has been used, it needs time to be charged again. To maintain the desired temperature during idling, the water in the storage charging tank is

circulated through the heat exchanger. In the event of DH interruption for short time, the storage charging tank can supply the remaining capacity of DHW. However, with a large-volume tank, the risk of bacterial growth is increased.

Local maintenance regulations should be observed concerning cleaning schedules. The system is typically controlled by an electronic weather compensator.

#### Areas of use:

Multi-family houses  
Commercial buildings

#### DH system types:

PN10 & PN16 bar	$T < 110^{\circ}\text{C}$
PN16 bar	$T \geq 110^{\circ}\text{C}$
PN25 bar	$T \geq 110^{\circ}\text{C}$

#### Typical markets:

Central Europe



London, United Kingdom – Multi-family with heating and instantaneous DHW production.



## Application limitations

### Heating (HE) circuit

- Expensive system
- The secondary system needs an expansion vessel

### Domestic hot water (DHW) circuit

- Higher system price compared to an application with instantaneous DHW preparation due to cost of storage charging tank, pump and sensor
- Limited capacity
- Higher risk of bacterial growth compared to an application with instantaneous DHW preparation
- Large space requirement
- Large heat loss from the installation
- Not suitable for low temperature systems
- Regular maintenance and cleaning required
- High primary return temperature compared to an application with instantaneous DHW preparation, but lower than cylinder application



## Directly connected HE with mixing loop and DHW charging application

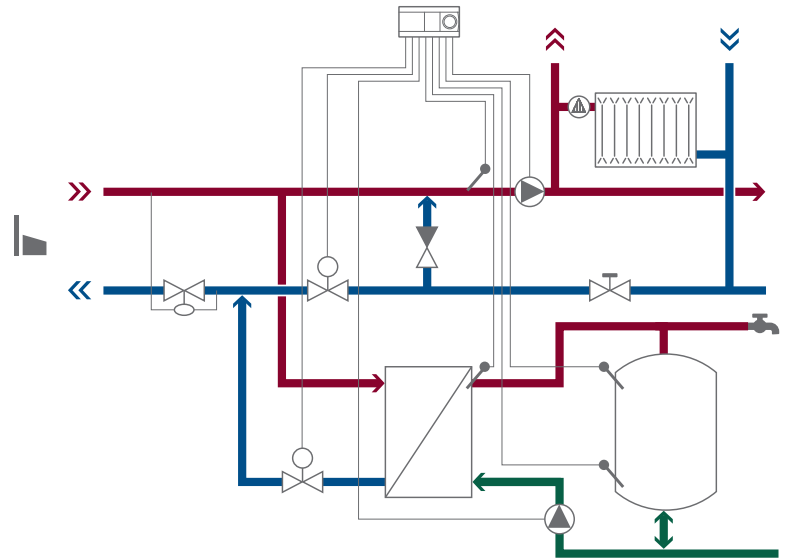

Directly connected heating application with mixing loop for radiator, floor heating and AC systems.

DHW charging tank application suitable for central boiler applications, but applicable in connection with DH.

### How it works

The HE system is directly connected to the DH network with a mixing loop.

Directly connected applications increase the risk of contamination of DH water and risk huge leakage in buildings.

The secondary flow temperature is adapted to the heat demand of the building by means of a mixing loop. To avoid 'back-flow', a check valve is mounted in the mixing loop. In addition, a differential pressure controller is applied for limitation of the differential pressure across the thermostatic radiator valves.

DHW is heated in a heat exchanger and let into a storage charging tank.

Once the DHW capacity has been used, it needs time to be charged again.

To maintain the desired temperature during idling, the water in the storage charging tank is circulated through the heat exchanger. In the event of DH interruption for a short time, the storage charging tank can supply the remaining capacity of DHW. However, with a large-volume tank, the risk of bacterial growth is increased. Local maintenance regulations should be observed concerning cleaning schedules.

The system is typically controlled by an electronic weather compensator.

#### Areas of use:

Multi-family houses  
Commercial buildings

#### DH system types:

PN10 bar

$T \leq 90^\circ\text{C}$

#### Typical markets:

Denmark



Moscow, Russia – Multi-family buildings with district heating inside.



## Application limitations

### Heating (HE) circuit

- DH water is not separated from the house system
- If the primary water is not well treated, there is a risk of corrosion in the house system
- Risk of impurities from the house system to the DH water
- Potential risk of huge leakage and DH water draining from the house system
- If the maintenance of the secondary side is not clearly defined, this system is not recommended
- No clear definition of capacity limitation where no flow controller is installed

### Domestic hot water (DHW) circuit

- Higher system price compared to an application with instantaneous DHW preparation due to cost of storage charging tank, pump and sensor
- Limited capacity
- Higher risk of bacterial growth compared to an application with instantaneous DHW preparation
- Large space requirement
- Large heat loss from the installation
- Not suitable for low-temperature systems
- Regular maintenance and cleaning required
- High primary return temperature compared to an application with instantaneous DHW preparation, but lower than cylinder application

## Directly connected HE and DHW charging application

Directly connected heating application for radiator, floor heating and AC systems.

DHW charging tank application suitable for central boiler applications, but applicable in connection with DH.

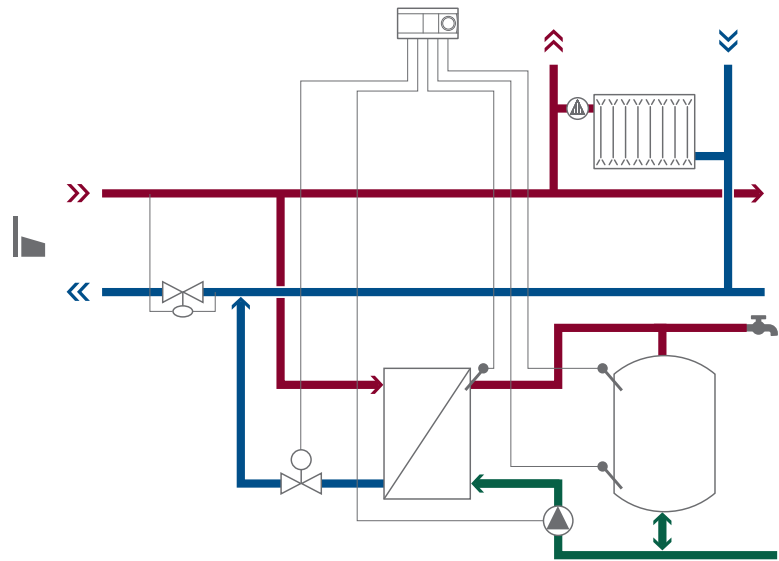

### How it works

The HE system is directly connected to the DH network. Directly connected applications increase the risk of contamination of DH water and risk huge leakage in buildings.

The HE temperature is flow-controlled by means of a radiator thermostat, a return temperature limiter or a room thermostat controlling a zone valve. In addition, a differential pressure controller is applied for limitation of the differential pressure across the thermostatic radiator valves.

DHW is heated in a heat exchanger and let into a storage charging tank. Once the DHW capacity has been used, it needs

time to be charged again. To maintain the desired temperature during idling, the water in the storage charging tank is circulated through the heat exchanger.

In the event of DH interruption for a short time, the storage charging tank can supply the remaining capacity of DHW.

However, with a large-volume tank, the risk of bacterial growth is increased. Local maintenance regulations should be observed concerning cleaning schedules.

The HE system can only be self-acting controlled. The DHW system is typically electronically controlled.

#### Areas of use:

Multi-family houses  
Commercial buildings

#### DH system types:

PN10 bar	T ≤ 90°C
----------	----------

#### Typical markets:

Denmark



Tuzla, Bosnia & Herzegovina – Multi-family buildings with district heating inside.

## Application limitations



### Heating (HE) circuit

- Return temperature limitation is only possible through self-acting return temperature limiter
- No possibility of changing flow temperatures for the building
- If the DH water is not well treated, there is a risk of corrosion in the building system
- Risk of impurities from the building system to the DH water
- Potential of huge leakage in the building
- If the maintenance of the secondary side is not clearly defined, this system is not recommended
- No clear definition of capacity limitation, where no flow controller is installed
- No periodic set back
- High system heat loss, when flow temperature is higher than actual demand

### Domestic hot water (DHW) circuit

- Higher system price compared to an application with instantaneous DHW preparation due to cost of storage charging tank, pump and sensor
- Limited capacity
- Higher risk of bacterial growth compared to an application with instantaneous DHW preparation
- Large space requirement
- Large heat loss from the installation
- Not suitable for low-temperature systems
- Regular maintenance and cleaning required
- High primary return temperature compared to an application with instantaneous DHW preparation, but lower than cylinder application



Overview								
1	2	3	4	5	6	7	8	9
0.1	1.0	1.F	1.1	1.2	1.3	1.1.1	S.1.2	S.1.3
0.2	2.0	2.F	2.1	2.2	2.3	1.1.2		
0.3	3.0	3.F	3.1	3.2	3.3			

## 6. Directly and indirectly connected room heating and domestic hot water cylinder applications

Preparation of domestic hot water in a cylinder with an internal coil and room heating applications can be combined either indirectly connected to the DH network, or alternatively as directly connected with or without mixing loop.

- 1.3** Indirectly connected HE and DHW preparation by cylinder
- 2.3** Directly connected HE with mixing loop and DHW preparation by cylinder
- 3.3** Directly connected HE and DHW preparation by cylinder

## Indirectly connected HE and DHW cylinder application

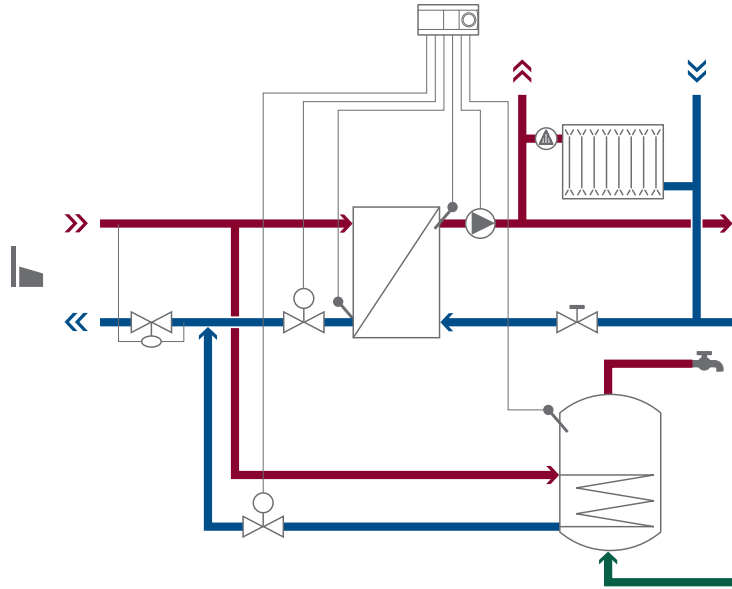

Indirectly connected heating application for radiator, floor heating and AC systems.

DHW cylinder application suitable for central boiler applications, but applicable in connection with DH.

### How it works

The heat exchanger physically separates the DH network and the HE circuit. The application minimizes the risk of contamination of DH water as well as the risks and consequences of leakage in apartments. The secondary flow temperature is adapted to the heat demand of the building.

DHW is heated in a cylinder by an internal heating coil. Once the DHW capacity has been used, it needs time to be charged again.

In the event of DH interruption for a short time, the cylinder can supply the remaining capacity of DHW. However,

with a large-volume cylinder, the risk of bacterial growth is increased. Local maintenance regulations should be observed concerning cleaning schedules.

This application is typically electronically controlled, but can be self-acting controlled in one-family houses. The DHW system can be either electronically or self-acting controlled. For small systems, it is typically self-acting controlled.

#### Areas of use:

- One-family houses
- Multi-family houses
- Commercial buildings

#### DH system types:

PN10 bar	$T \leq 90^{\circ}\text{C}$
PN10 & PN16 bar	$T < 110^{\circ}\text{C}$
PN16 bar	$T \geq 110^{\circ}\text{C}$

#### Typical markets:

Germany, Italy and Austria



Linz, Austria – Multi-family buildings supplied with district heating.



## Application limitations

### Self-acting control

- No periodic set back
- High system heat loss when flow temperature is higher than actual demand
- No additional functions as pump control

### Heating (HE) circuit

- Expensive system
- The secondary system needs an expansion vessel

### Domestic hot water (DHW) circuit

- Higher system price compared to an application with instantaneous DHW preparation due to cost of cylinder and sensor
- Ineffective charging
- Limited capacity
- Higher risk of bacterial growth compared to an application with instantaneous DHW preparation
- Large space requirement
- Large heat loss from the installation
- Not suitable for low-temperature systems
- Regular maintenance and cleaning required
- High primary return temperature, compared to an application with instantaneous DHW preparation and storage charging tank application

## Directly connected HE with mixing loop and DHW cylinder application

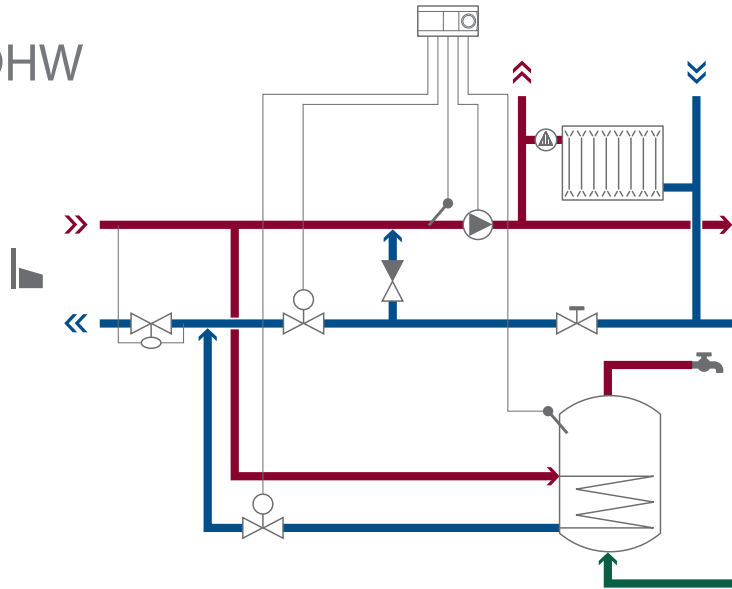

Directly connected heating application with mixing loop for radiator, floor heating and AC systems.

DHW cylinder application suitable for central boiler applications, but applicable in connection with DH.

### How it works

The HE system is directly connected to the DH network with a mixing loop. Directly connected applications increase the risk of contamination of DH water and risk huge leakage in buildings.

The secondary flow temperature is adapted to the heat demand of the building by means of a mixing loop. To avoid 'back-flow', a check valve is mounted in the mixing loop. In addition, a differential pressure controller is applied for limitation of the differential pressure across the thermostatic radiator valves.

DHW is heated in a cylinder by an internal heating coil. Once the DHW

capacity has been used, it needs time to be charged again. In the event of DH interruption for a short time, the cylinder can supply the remaining capacity of DHW. However, with a large-volume cylinder, the risk of bacterial growth is increased. Local maintenance regulations should be observed concerning cleaning schedules.

This application is typically electronically controlled, but can be self-acting controlled in one-family houses. The DHW system can be either electronically or self-acting controlled for small systems.

#### Areas of use:

- One-family houses
- Multi-family houses
- Commercial buildings

#### DH system types:

PN10 bar	T ≤ 90°C
----------	----------

#### Typical markets:

Denmark and in secondary systems



*Bucharest, Romania – Multi-family and commercial buildings supplied with district heating.*



## Application limitations

### Self-acting control

- No periodic set back
- High system heat loss when flow temperature is higher than actual demand
- No additional functions as pump control

### Heating (HE) circuit

- DH water is not separated from the house system
- If the primary water is not well treated, there is a risk of corrosion in the house system
- Risk of impurities from the house system to the DH water
- Potential risk of huge leakage and DH water draining from the house system
- If the maintenance of the secondary side is not clearly defined, this system is not recommended
- No clear definition of capacity limitation, where no flow controller is installed

### Domestic hot water (DHW) circuit

- Higher system price compared to an application with instantaneous DHW preparation due to cost of cylinder and sensor
- Ineffective charging
- Limited capacity
- Higher risk of bacterial growth compared to an application with instantaneous DHW preparation
- Large space requirement
- Large heat loss from the installation
- Not suitable for low-temperature systems
- Regular maintenance and cleaning required
- High primary return temperature, compared to an application with instantaneous DHW preparation and storage charging tank application

## 6.3.3 Application not recommended

### Directly connected HE and DHW cylinder application

Directly connected heating application for radiator, floor heating and AC systems.

DHW cylinder application suitable for central boiler applications, but applicable in connection with DH.

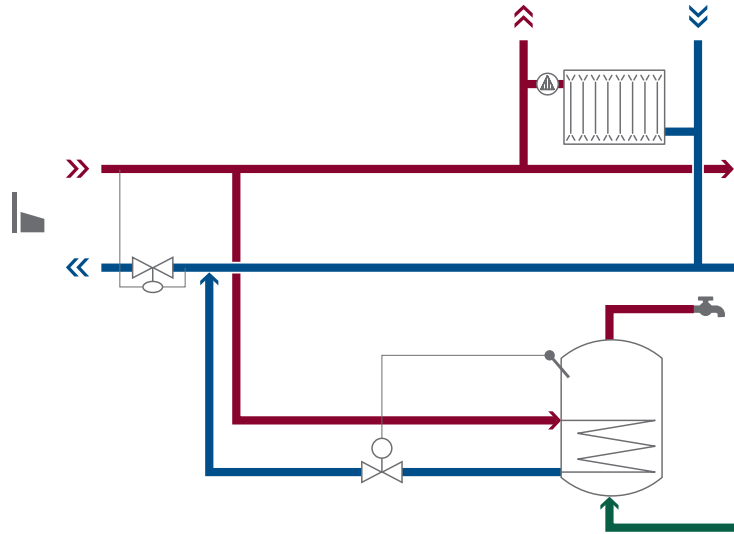

### How it works

The HE system is directly connected to the DH network. Directly connected applications increase the risk of contamination of DH water and risk huge leakage in buildings.

The HE temperature is flow-controlled by means of a radiator thermostat, a return temperature limiter or a room thermostat controlling a zone valve. In addition, a differential pressure controller is needed for limitation of the differential pressure across the thermostats on the radiators.

DHW is heated in a cylinder by an internal heating coil. Once the DHW

capacity has been used, it needs time to be charged again.

In the event of DH interruption for a short time, the cylinder can supply the remaining capacity of DHW. However, with a large-volume cylinder, the risk of bacterial growth is increased. Local maintenance regulations should be observed concerning cleaning schedules.

The HE system can only be self-acting controlled. The DHW system is typically self-acting but can also be electronically controlled.

#### Areas of use:

One-family houses

#### DH system types:

PN10 bar

$T \leq 90^{\circ}\text{C}$

#### Typical markets:

Denmark and in secondary systems



Billund, Denmark – One-family houses supplied with district heating.

## Application limitations



### Heating (HE) circuit

- Return temperature limitation is only possible through self-acting return temperature limiter
- No possibility of changing flow temperatures for the building
- If the DH water is not well treated, there is a risk of corrosion in the building system
- Risk of impurities from the building system to the DH water
- Potential of huge leakage in the building
- If the maintenance of the secondary side is not clearly defined, this system is not recommended
- No clear definition of capacity limitation, where no flow controller is installed
- No periodic set back
- High system heat loss when flow temperature is higher than actual demand

### Domestic hot water (DHW) circuit

- Higher system price compared to an application with instantaneous DHW preparation due to cost of cylinder and sensor
- Ineffective charging
- Limited capacity
- Higher risk of bacterial growth compared to an application with instantaneous DHW preparation
- Large space requirement
- Large heat loss from the installation
- Not suitable for low-temperature systems
- Regular maintenance and cleaning required
- High primary return temperature, compared to an application with instantaneous DHW preparation and storage charging tank application



BRUGSVAND  
KOLDT

BRUGSVAND

Overview								
1	2	3	4	5	6	7	8	9
0.1	1.0	1.F	1.1	1.2	1.3	1.1.1	S.1.2	S.1.3
0.2	2.0	2.F	2.1	2.2	2.3	1.1.2		
0.3	3.0	3.F	3.1	3.2	3.3			

## 7. Two-step applications

The difference between two-step applications and the previous applications is that in domestic hot water preparation, the cold water is pre-heated by return water from the room heating before it is fully heated by the district heating supply water. Further on, the domestic hot water can be prepared instantaneously or charged into a tank.

- 1.1.1 Indirectly connected HE and instantaneous DHW preparation with a heat exchanger
- 1.1.2 Indirectly connected HE and instantaneous DHW preparation with a heat exchanger and storage charging tank



## Indirectly connected two-step HE and instantaneous DHW application

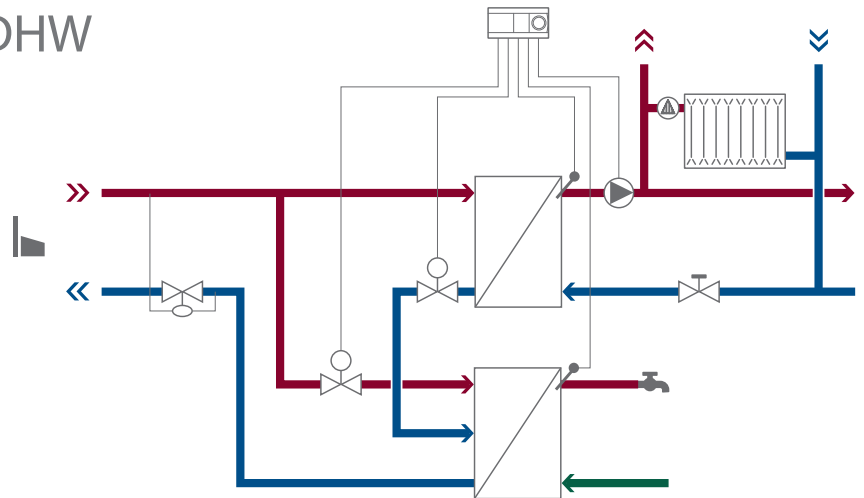

Indirect two-step heating application for radiator, floor heating and AC systems.

Instantaneous DHW preparation with heat exchanger.

### How it works

The heat exchanger physically separates the DH network and the HE circuit. The application minimizes the risk of contamination of DH water as well as the risks and consequences of leakage in apartments. The secondary flow temperature is adapted to the heat demand of the building.

The DHW is prepared with a two-step heat exchanger. At the first part of the heat exchanger, the return flow from the HE heat exchanger is used to preheat the DCW and further cool the return temperature.

At the second part, a forward DH flow is used to add the amount of heat needed to achieve the desired DHW temperature. To ensure a stable DHW temperature at part load, it is important to equip the system with a differential pressure controller.

The DHW volume is limited compared to storage charging tank or cylinder applications, thus reducing the risk of bacterial growth.

2-step systems are only beneficial during the winter time, where DCW can be preheated to a level of 35-40°C. The second part of the heat exchanger will therefore only need to increase the DHW temperature from this level to the desired DHW temperature.

The system is electronically controlled. For comfort and energy-saving reasons electronic control with weather compensation is recommended in floor heating and radiator applications.

#### Areas of use:

Multi-family houses  
Commercial buildings

#### DH system types:

PN10 & PN16 bar	$T < 110^{\circ}\text{C}$
PN16 bar	$T \geq 110^{\circ}\text{C}$
PN25 bar	$T \geq 110^{\circ}\text{C}$

#### Typical markets:

Sweden, Finland, Central and Eastern Europe



Changchun, China – Multi-family and commercial buildings with district heating inside.



## Application limitations

- On average, 2-step systems result in annual mean return temperatures 1-2°C lower than 1-step parallel systems, which implies that it may be more important to optimize the building heating system than choosing between 1-step systems and the more expensive 2-step systems. *Reference [6]*.
- Typical design return temperature from heating should be  $\geq 50^{\circ}\text{C}$ , but for DHW safety reasons not higher than  $65^{\circ}\text{C}$
- Typical capacity between HE and DHW should be in the range  $Q(\text{DHW}) : Q(\text{HE})$  in the range 1:1 to 1:3, but also dependent on the temperatures
- High system price

### Heating (HE) circuit

- The secondary system needs an expansion vessel

### Domestic hot water (DHW) circuit

- No DHW supply in case of DH supply interruption
- Design capacity ( $\text{m}^3/\text{h}$ ) on DH side is higher per consumer compared to storage charging tank and cylinder applications: for a group of consumers, typically 10-30 consumers, the design capacity is however lower for an application with instantaneous DHW production
- Risk of oscillation of the DHW temperature at low load due to control valve operation at low opening degrees
- Challenge for controller to maintain constant DHW temperature due to influence from DHW load and heating circuit return temperature and flow



## Indirectly connected two-step HE and DHW charging application

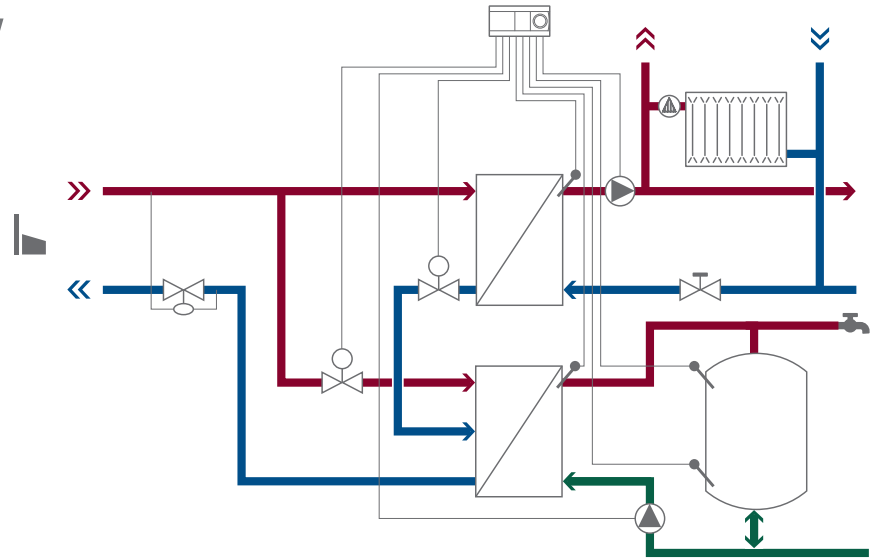

Indirectly connected two-step HE and DHW charging application.

### How it works

The heat exchanger physically separates the DH network and the HE circuit. The application minimizes the risk of contamination of DH water as well as the risks and consequences of leakage in apartments. The secondary flow temperature is adapted to the heat demand of the building.

The DHW is prepared with a two-step heat exchanger. At the first part of the heat exchanger, the return flow from the HE heat exchanger is used to preheat the DCW and further cool the return temperature.

At the second part, a forward DH flow is used to add the amount of heat needed to achieve the desired DHW temperature in the storage charging tank.

Once the DHW capacity has been used, it needs time to be charged again. To maintain desired temperature during idling, the water in the storage charging tank is circulated through the heat exchanger.

In the event of DH interruption for a short time, the storage charging tank can supply the remaining capacity of DHW. However, with a large-volume tank, the risk of bacterial growth is increased. Local maintenance regulations should be observed concerning cleaning schedules.

For a stable DHW temperature at part load, it is important to equip the system with a differential pressure controller. 2-step systems are only beneficial during the winter time where DCW can be preheated to a level of 35-40°C. The second part of the heat exchanger will therefore only need to increase the DHW temperature from this level to the desired DHW temperature.

The system is electronically controlled. For comfort and energy-saving reasons, electronic control with weather compensation is recommended in floor heating and radiator applications.

#### Areas of use:

Multi-family houses  
Commercial buildings

#### DH system types:

PN10 & PN16 bar	$T < 110^{\circ}\text{C}$
PN16 bar	$T \geq 110^{\circ}\text{C}$
PN25 bar	$T \geq 110^{\circ}\text{C}$

#### Typical markets:

Central Europe



Hamburg, Germany – Multi-family and commercial buildings with heating and instantaneous domestic hot water production.



## Application limitations

- The annual mean return temperature of a two-step system with storage charging tank will be even lower than without a storage charging tank; however, the cost of storage charging tank, pump, sensor and general service costs may outweigh the benefits of the reduced heat loss – this implies that it may be more important to optimize the heating system than choosing between 1-step systems and the more expensive 2-step systems
- Typical design return temperature from heating should be  $\geq 50^{\circ}\text{C}$ , but for safety reasons not higher than  $65^{\circ}\text{C}$
- Typical capacity between heating and DHW,  $Q(\text{DHW}) : Q(\text{HE})$ , should be in the range 1:1 to 1:3, but it also depends on the temperatures
- High system price

### Heating (HE) circuit

- The secondary system needs an expansion vessel

### Domestic hot water (DHW) circuit

- High  $\Delta P$  across the DHW heat exchanger
- Risk of oscillation of the DHW temperature at low load due to control valve operation at low opening degrees
- Challenge for controller to maintain constant DHW temperature due to influence from DHW load and heating circuit return temperature and flow
- Higher system price compared to an application with instantaneous DHW preparation due to cost of storage charging tank, pump and sensor
- Limited capacity
- Higher risk of bacterial growth compared to an application with instantaneous DHW preparation
- Large space requirement
- Large heat loss from the installation
- Not suitable for low-temperature systems
- Regular maintenance and cleaning required
- High primary return temperature compared to an application with instantaneous DHW preparation, but lower than cylinder application



Overview								
1	2	3	4	5	6	7	8	9
0.1	1.0	1.F	1.1	1.2	1.3	1.1.1	S.1.2	S.1.3
0.2	2.0	2.F	2.1	2.2	2.3	1.1.2		
0.3	3.0	3.F	3.1	3.2	3.3			

## 8. Indirectly connected room heating and secondary side connected domestic hot water charging tank application S.1.2

The indirectly connected room heating and secondary side connected domestic hot water charging tank application is a variation of the direct room heating and domestic hot water charging tank application (5.1.2) – except in this case the building is separated by a heat exchanger and the domestic hot water preparation is done on the secondary side.

The application is typically used when double separation between the district heating water and domestic hot water is required.

## Indirectly connected HE and secondary side connected DHW charging application

Indirectly connected heating application for radiator, floor heating and AC systems.

DHW charging tank application (secondary side connected) suitable for central boiler applications, but applicable in connection with DH.

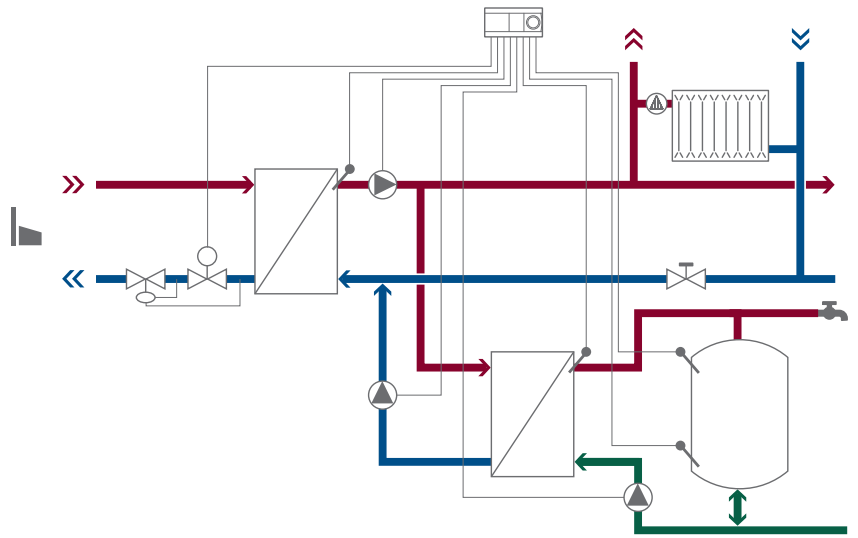

## How it works

The heat exchanger physically separates the DH network and the HE circuit. The application minimizes the risk of contamination of DH water as well as the risks and consequences of leakage in apartments. The secondary flow temperature is adapted to the heat demand of the building.

However, a minimum flow temperature for the storage charging system is applied as well.

The DHW is heated in the secondary circuit with a heat exchanger and let into a storage charging tank. Once the DHW capacity has been used, it needs time to be charged again. To maintain desired temperature during idling, the water in the storage charging tank is circulated through the heat exchanger.

In the event of DH interruption for a short time, the storage charging tank can supply the remaining capacity of DHW.

However, with a large-volume tank, the risk of bacterial growth is increased. Local maintenance regulations should be observed concerning cleaning schedules.

A hot water priority can be achieved with different control options, for example pumps or an on/off 3-way valve.

This system is generally used where the tariff allocation depends on the capacity needed for the system.

This system can only be electronically controlled. For comfort and energy-saving reasons, electronic control with weather compensation is recommended in floor heating and radiator applications.

This application is typically applied where safety thermostats are required. It can also be used where double separation between DH water and DHW is required.

### Areas of use:

Multi-family houses  
Commercial buildings

### DH system types:

PN16 bar	$T \geq 110^{\circ}\text{C}$
PN25 bar	$T \geq 110^{\circ}\text{C}$

### Typical markets:

Germany, Italy and Austria



Munich, Germany – Commercial building with heating and domestic hot water production.



## Application limitations

- High system price when not applying priority between DHW and HE

### Heating (HE) circuit

- The secondary system needs an expansion vessel

### Domestic hot water (DHW) circuit

- Higher system price compared to an application with instantaneous DHW preparation due to cost of storage charging tank, pump and sensor
- Limited capacity
- Higher risk of bacterial growth compared to an application with instantaneous DHW preparation
- Large space requirement
- Large heat loss from the installation
- Not suitable for low-temperature systems
- Regular maintenance and cleaning required
- High primary return temperature compared to an application with instantaneous DHW preparation, but lower than cylinder application
- Due to heat transfer through two heat exchangers, the return temperature will be higher for the DHW system compared to the parallel system.



BRUGSVAND  
VARMT Cirk.

Overview								
1	2	3	4	5	6	7	8	9
0.1	1.0	1.F	1.1	1.2	1.3	1.1.1	S.1.2	S.1.3
0.2	2.0	2.F	2.1	2.2	2.3	1.1.2		
0.3	3.0	3.F	3.1	3.2	3.3			

## 9. Indirectly connected room heating and secondary side connected domestic hot water cylinder application S.1.3

The indirectly connected room heating and secondary side connected hot water cylinder application is a variation of the direct room heating and domestic hot water cylinder application (6.1.3) – except in this case the building is separated by a heat exchanger and the domestic hot water preparation is done on the secondary side.

The application is typically used when double separation between the district heating water and domestic hot water is required.

## Indirectly connected HE and secondary side connected DHW cylinder application

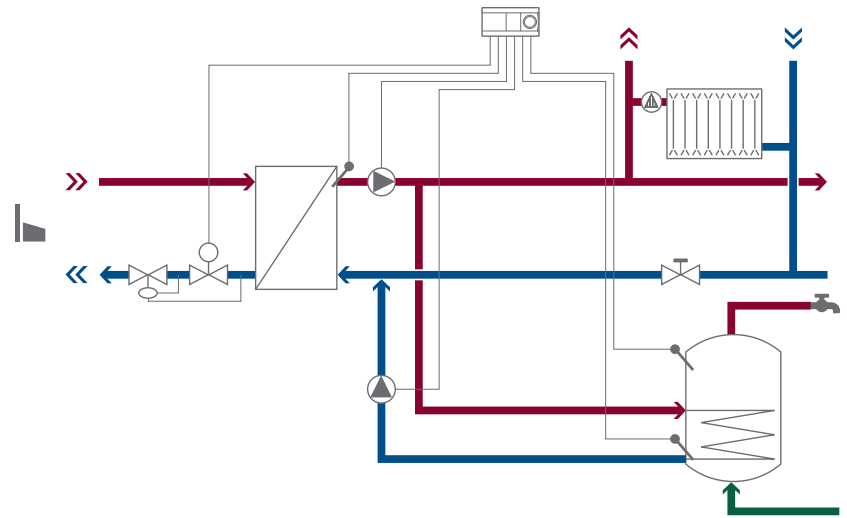

Indirectly connected heating application for radiator, floor heating and AC systems.

DHW cylinder application (secondary side connected) typical for boiler systems, but can also be connected in a DH system.

## How it works

The heat exchanger physically separates the DH network and the HE circuit. The application minimizes the risk of contamination of DH water as well as the risks and consequences of leakage in apartments. The secondary flow temperature is adapted to the heat demand of the building. But a minimum flow temperature for the cylinder is applied as well.

DHW is heated in the secondary circuit in a cylinder by an internal heating coil. Once the DHW capacity has been used, it needs time to be charged again. In the event of DH interruption for short a time, the cylinder can supply the remaining capacity of DHW. However, with a large-volume cylinder, the risk of bacterial growth is increased. Local maintenance

regulations should be observed concerning cleaning schedules. A hot water priority can be achieved with different control options, for example pumps or an on/off 3-way valve.

This system is generally used where the tariff allocation depends on the capacity needed for the system.

This system can only be electronically controlled. For comfort and energy-saving reasons, electronic control with weather compensation is recommended in floor heating and radiator applications. It is typically applied where safety thermostats are required. This application can also be used where double separation between DH water and DHW is required.

### Areas of use:

Multi-family houses  
Commercial buildings

### DH system types:

PN16 bar	$T \geq 110^{\circ}\text{C}$
PN25 bar	$T \geq 110^{\circ}\text{C}$

### Typical markets:

Germany, Italy and Austria



Walz, Austria – Multi-family buildings with district heating inside.



## Application limitations

- High system price, when not applying priority between DHW and HE

### Heating (HE) circuit

- The secondary system needs an expansion vessel

### Domestic hot water (DHW) circuit

- Higher system price compared to an application with instantaneous DHW preparation due to cost of cylinder and sensor
- Ineffective charging
- Limited capacity
- Higher risk of bacterial growth compared to an application with instantaneous DHW preparation
- Large space requirement
- Large heat loss from the installation
- Not suitable for low-temperature systems
- Regular maintenance and cleaning required
- High primary return temperature compared to an application with instantaneous DHW preparation and storage charging tank applications
- Due to heat transfer through two heat exchangers (heat exchanger and coil), the return temperature will be higher for the DHW system compared to the parallel system



# About Danfoss District Energy

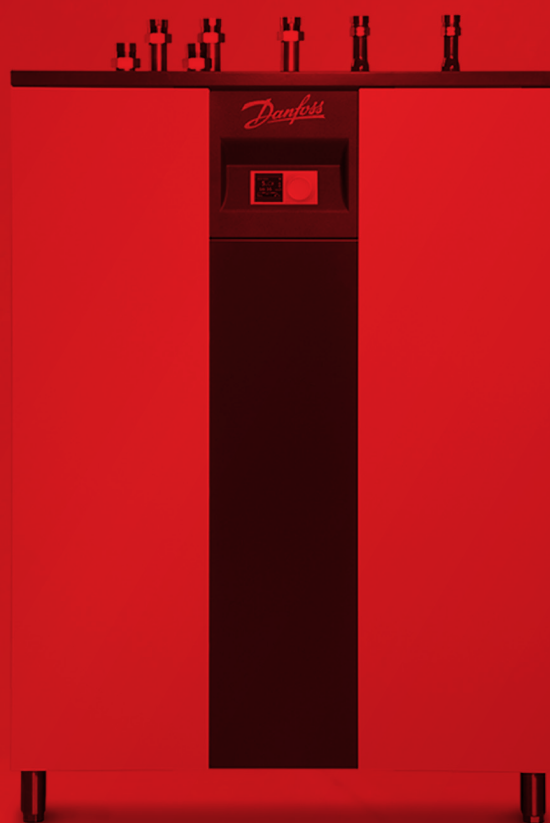

# We mind your business

Danfoss is more than a household name in heating. Driven by our customers' needs, we build on years of experience to be at the forefront of innovation, continually supplying both expertise, components and complete systems for district heating and cooling applications.

As the leading total supplier, Danfoss provides customers worldwide with a complete range of automatic controls, heat exchangers, domestic hot water systems and substations, which are applied throughout the process of generating, distributing and controlling heat to homes and buildings.

The products contribute to individual comfort and reduce energy consumption as well as providing reliable and lasting operations and guaranteeing minimum servicing.



## Build on site – components

Whether you are building heat transfer district heating stations or involved in the design of the heating system application, Danfoss can offer components and inherent knowledge that enables you to optimize the total solution and cope with current and future demands.

**Keep your focus on performance**  
Using top-performing Danfoss controls and components for constructing your heating system allows you to focus on enhancing total system performance, and thereby creating superior solutions for you and your customers.

### A complete product range:

- » Electronic controllers
- » Motorized control valves
- » Self-acting pressure, flow and temperature controllers
- » Ball valves
- » Energy meters
- » Plate heat exchangers

For more information, please visit [www.districtenergy.danfoss.com](http://www.districtenergy.danfoss.com)

# – and your applications

Doing business with Danfoss means gaining access to industry leading:

- » Product portfolio for district heating and cooling
- » Consultancy and customer dedication
- » Innovation, technical optimization and performance
- » Safety and reliability in cooperation
- » Global reach with strong local representation and knowledge

Danfoss is therefore a sound choice whenever district heating and cooling systems are to be planned, installed and upgraded.

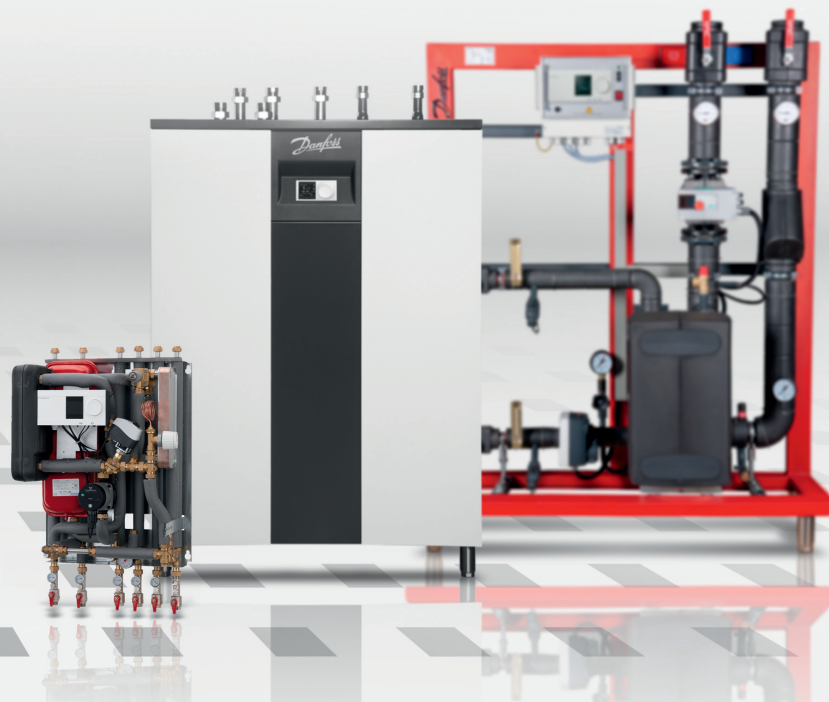

## Build to site – predefined applications

Are you looking for new heat transfer technology and higher energy efficiency? Do you want to optimize the use and appearance of your heating room? Do you want high-performance and more time for your regular activities?

Danfoss enables you to deliver complete district heating substations that are optimized for high heat transfer performance

with state-of-the-art control components. Danfoss substations can be rapidly designed, configured and manufactured. They are tested before delivery to ensure straightforward installation and a perfect fit in building services systems. This enables you and your customers to work smarter, save time and money, and reduce the amount of space occupied by your heating system.

### A complete product range:

- » Fitted substations (15kW – 300 MW)
- » Welded substations and mixing loops (15kW – 40 MW)
- » Domestic hot water systems

# Appendix



## Considerations for DHW preparation for commercial and industrial buildings

### Recreation, health, industry and other specialist sectors

In addition to the residential market for DH, recreation, health, industry and other specialist sectors can all benefit from DH solutions.

A difference between the residential sector and other sectors can be the DHW draw-off profile and the required capacity for DHW compared to HE capacity. In the event that the DHW peak load is high compared to the HE load, an application in combination with the storage charging system can be worth considering.

In general, if the DHW draw-off profile is based on stochastic events, as is the case for the residential sector where there is no systematic DHW tapping peak for a group of consumers, then the application to be recommended is as stated in the System Selection overviews.

In the case of systematic DHW tapplings, e.g. for sport facilities where high peak loads occur due to simultaneous tapping of DHW, combinations with storage charging systems can be recommended. In this way, DH capacity is significantly reduced compared to the instantaneous heat exchanger principle. This has a positive influence on the dimensioning of the DH branch pipes and thus DH distribution heat losses.

Examples of sectors where combinations with storage charging tank systems are recommended include:

- Recreation sector: sports facilities, swimming pools, wellness facilities and hotels
- Health sector: hospitals
- Industry: factory facilities
- Special sectors: military facilities

For these sectors, it is recommended to perform an individual analysis of which application, storage charging tank system or instantaneous heat exchanger is the best option.





















# Abbreviations

(In non-prioritized order or other subheader)

AC	Air conditioning	FH	Hydronic floor heating
DCW	Domestic cold water	HE	Room heating
DH	District heating	PN	Nominal pressure (bar, kPa)
DHW	Domestic hot water	SCADA	System control and data acquisition system
dP	Differential pressure	T	Temperature

# Application symbols

	ECL Comfort 210 / 310		Pressure-relieved solenoid valve
	Contra valve / Non-return valve		Throttle valve
	Circulation pump		Water tap
	Motorized control valve		District heating plant
	Motorized control valve with built-in pressure controller		Radiator (heat emitter)
	Combined pressure and flow control valve		Heat exchanger
	Differential pressure control valve or flow control valve		DHW cylinder tank
	Motorized control valve with pressure and flow control		DHW charging tank
	Shut-off valve (ball valve)		Flat station
	Solenoid valve		

# Reference list

- [1] Report made by consulting firm COWI A/S. Energibesparelser ved vejrkomensering. March, 2010, Denmark.
- [2] Danfoss A/S pricelist. April, 2012, Denmark.
- [3] Jan Eric Thorsen and Halldor Kristjansson. Cost Considerations on Storage Tank versus Heat Exchanger for Hot Water Preparation. In proceedings of: 10th International Symposium District Heating and Cooling , Hanover, Germany, 3rd-5th of September, 2006.
- [4] DVGW regulations, Germany, Arbeitsblatt W551, April 2004
- [5] Jan Eric Thorsen. Analysis on flat station concept. In proceedings of: 12th International Symposium District Heating and Cooling, Tallin, Estonia, 5th-7th of September, 2010.
- [6] Case story: Danflat leads to huge energy savings in housing association. <http://heating.danfoss.com/xxNewsx/e29ab581-336d-400c-983d-f92e9b987c72.html>
- [7] Håkon Waltetun, ZW Energiteknik AB. Teknisk och ekonomisk jämförelse mellan 1- och 2-stegskopplade fjärrvärmecentraler, Svenska Fjärrvärmeföreningens Service AB, 2002, ISSN 1402-5191

## Other relevant literature:

### Controllers

- [8] Herman Boysen. Differential pressure controllers as a tool for optimization of heating systems. Published in: Euro Heat & Power 1/2003.
- [9] Herman Boysen. Hydronic balance in a district cooling system. Published in: Hot & Cool, International magazine on district heating and cooling, 4/2003.
- [10] Herman Boysen and Jan Eric Thorsen. Hydronic balance in a district heating system. Published in: Euro Heat & Power 4/2007.

### Substations

- [11] Herman Boysen. District heating house substations. Published in: News from DBDH, 2/1999.
- [12] Herman Boysen. Selection of DH house stations. Published in: Euro Heat & Power 3/2004.
- [13] Herman Boysen and Jan Eric Thorsen. Control concepts for district heating compact stations. Published in: Euro Heat & Power 4/2004.
- [14] Jan Eric Thorsen. Dynamic simulation of DH House stations. Published in: Euro Heat & Power 6/2003.

### Systems

- [15] Halldor Kristjansson and Benny Bøhem. Optimum Design of Distribution and service Pipes. In proceedings of: 10th International Symposium District Heating and Cooling , Hanover, Germany, 3rd-5th of September, 2006.
- [16] Herman Boysen and Jan Eric Thorsen. How to avoid pressure oscillations in district heating systems. Published in: Euro Heat & Power 2/2003.

### Domestic hot water

- [17] Jan Eric Thorsen and Halldor Kristjansson. Cost Considerations on Storage Tank versus Heat Exchanger for Hot Water Preparation. In proceedings of: 10th International Symposium District Heating and Cooling , Hanover, Germany, 3rd-5th of September, 2006.
- [18] Herman Boysen. Auto tuning and motor protection. Published in: News from DBDH, 3/2000.
- [19] Atli Benonysson and Herman Boysen. Optimum control of heat exchangers. In proceedings of: 5th International Symposium on Automation and of District Heating Systems, Finland, August, 1995.
- [20] Atli Benonysson and Herman Boysen. Valve characteristics for motorized valves. Published in: Euro Heat & Power 7-8/1999.

### Flat stations

- [21] Halldor Kristjansson. Distribution Systems in Apartment Buildings. In proceedings of: 11th International Symposium on Automation and of District Heating Systems, Reykjavik, Iceland, 31st of August to 2nd of September, 2008.
- [22] Halldor Kristjansson. Controls Providing Flexibility for the Consumer Increase Comfort and Save Energy. Published in: Hot & Cool, International magazine on district heating and cooling, 1/2008.
- [23] Jan Eric Thorsen, Henning Christensen and Herman Boysen. Trend for heating system renovation. Danfoss A/S Technical paper. [http://heating.danfoss.com/PCMPDF/VFHED102\\_trend\\_for\\_renovation.pdf](http://heating.danfoss.com/PCMPDF/VFHED102_trend_for_renovation.pdf)

### Other relevant literature

- [24] Herman Boysen. Kv factor. Danfoss A/S Technical paper. [http://heating.danfoss.com/PCMPDF/VFHBG102\\_Kv.pdf](http://heating.danfoss.com/PCMPDF/VFHBG102_Kv.pdf)

ENGINEERING  
TOMORROW



We mind your business

---

[www.districtenergy.danfoss.com](http://www.districtenergy.danfoss.com)

**Danfoss A/S** · DK-6430 Nordborg · Denmark · Tel.: +45 74 88 22 22 · Fax: +45 74 49 03 95

E-mail: [districtenergy@danfoss.com](mailto:districtenergy@danfoss.com) · [www.districtenergy.danfoss.com](http://www.districtenergy.danfoss.com)

---

Danfoss can accept no responsibility for possible errors in catalogues, brochures and other printed material. Danfoss reserves the right to alter its products without notice. This also applies to products already on order provided that such alterations can be made without subsequential changes being necessary in specifications already agreed. All trademarks in this material are property of the respective companies. Danfoss and the Danfoss logotype are trademarks of Danfoss A/S. All rights reserved.

---