



S-CSA HEX



S-CSA CS



S-CSA I



S-CSA P

PRODUCT DATA SHEET

CONCRETE SCREWS



ETA-approved concrete screws for cracked and non-cracked concrete.

Self-tapping, approved for push-through installations.

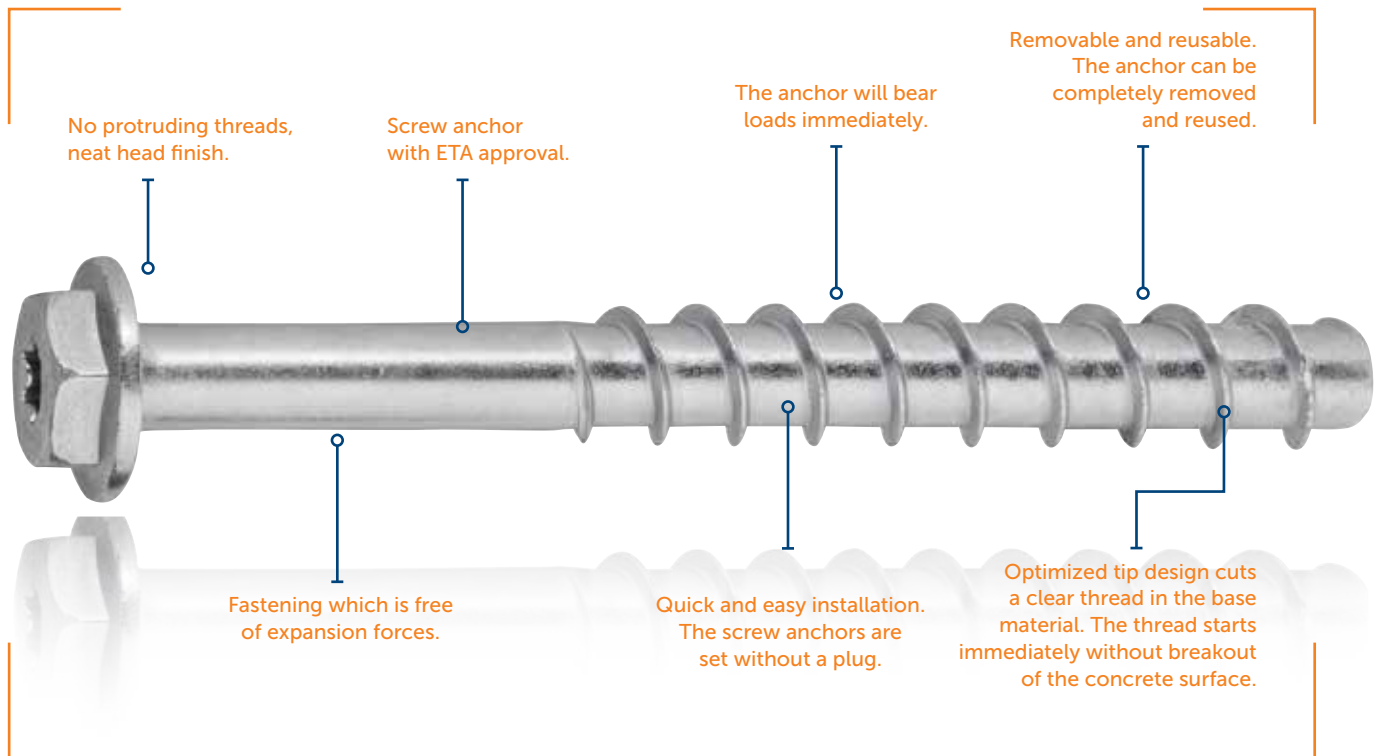

CONCRETE SCREW S-CSA

The S-CSA concrete screw is very easy and quick to install. Requires neither additional tools nor operations. It is able to take high loads even with small spacings and edge distances. It is removable and reusable and therefore fits well for temporary fixings.

Description

- Self-tapping, approved screw anchors for push-through installations.
- No expansion forces allowing for small edge distances and spacings.
- ZP (zinc electro plated) for dry indoor use.
- ML (Multi Layer coated) corrosion resistant coating. S-CSA ML has been neutral salt spray tested according to DIN EN ISO 9227 (prevention of red rust for more than 1000 h)
- Combines the benefits of undercut and chemical anchors requiring neither additional tools and operations nor hardening time.
- S-CSA HEX: hexagon head with combined washer
- S-CSA I: combined internal thread M8/M10
- S-CSA CS: countersunk head
- S-CSA P: pan head
- The concrete screw is installed directly through the fixture into the bore hole only by screwing. By doing so, the thread is cutting itself into the concrete and that way creating a mechanical interlock over the total anchorage depth.

Benefits

- Economic installation
- Quick and easy installation
- No expansion forces
- Small spacings and edge distances possible
- Removable
- Can be reused



S-CSA HEX

Carbon steel concrete screw with

- hexagonal head and T-drive (6, 8 mm)
- hexagonal head (5, 10 mm)

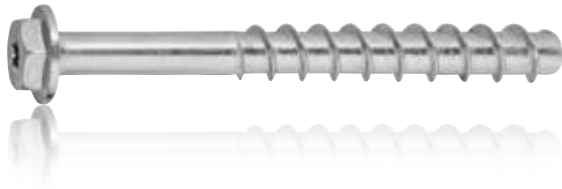

S-CSA P

Carbon steel concrete screw with pan head and T-drive



S-CSA CS

Carbon steel concrete screw with countersunk head and T-drive



S-CSA I

Carbon steel concrete screw with combined internal thread M8 / M10



Base materials

Approved for



Cracked concrete



Non-cracked concrete



Hollow concrete slab

Also suitable for







Solid clay brick



Solid sand-lime brick

APPROVALS / CERTIFICATIONS / APPLICATIONS

Description of document		Authority/ Laboratory	ID	Additional info
European Technical Assessment		ZAG -National Building and Civil Engineering Institute, Slovenia	ETA-16/0945	EAD 330232-00-0601, Option 1
European Technical Assessment		ZAG -National Building and Civil Engineering Institute, Slovenia	ETA-17/1009	Concrete screw of size 6 for multiple use in non-structural applications, ETAG 001, Part 6
Fire resistance		ZAG -National Building and Civil Engineering Institute, Slovenia	ETA-16/0945 ETA-17/1009	EOTA TR 020 EAD 330232-00-0601, Option 1 / CEN/TS 1992-4 ETAG 001, Part 6
YouTube installation videos		Sormat Oy	MFEKwYHP49c	Sormat S-CSA Concrete screw presentation video
Sormat Trustfix anchor calculation software		Sormat Oy / S&P Software Consulting		TrustFIX anchor calculation
Through bolts CAD-blocks for AutoCAD		Sormat Oy		Blocks installation instructions for AutoCAD

Additional information concerning all given data in the product data sheet

- Load figures include the partial safety factors as per approvals and a partial safety factor on the action of $\gamma_f = 1.4$. Load figures apply for a rebar spacing $s \geq 15$ cm or alternatively for a rebar spacing $s \geq 10$ cm in combination with a rebar diameter of $d_s \leq 10$ mm.
- If spacings or edge distances become smaller than the characteristic figures ($s_{cr,N} / c_{cr,N}$) a calculation as per EOTA TR 055 needs to be carried out. For more details, see ETA-16/0945 and ETA-17/1009.
- Concrete is considered non-cracked when the value of tension within the concrete is $\sigma_L + \sigma_R \leq 0$. In the absence of detailed verification $\sigma_R = 3$ N/mm² can be assumed (σ_L equals the tension within the concrete as a result of external loads, forces on anchor included; σ_R equals the tension coming from shrinkage or creep of the concrete, as well as displacements of supports or temperature variations).
- Shear load figures apply for an anchor without influence of a concrete edge. For shear loads close to an edge ($c \leq 10 \times h_{ef}$), concrete edge failure has to be checked as per EOTA TR 055.

STATIC AND QUASI-STATIC LOADS

The data of these tables is based on:

- Concrete C20/25, $f_{ck,cube} = 25 \text{ N/mm}^2$.
- Installation has been done correctly (see p. 10).
- No influence of edge distances and spacings (see p. 11).
- Respect of minimum base material thickness (see p. 11).
- S-CSA 6 $h_{nom} = 40 \text{ mm}$ for multiple use according to PART 6



Characteristic resistances

Anchor size	S-CSA 5		S-CSA 6		S-CSA 8		S-CSA 10	
Approval	-	-	PART6	OPT1	-	OPT1	-	OPT1
Effective anchorage depth h_{ef} [mm]	19,0	27,5	31,9	42,5	40,0	48,5	48,8	61,5
Nominal anchorage depth h_{nom} [mm]	35	45	40	55	55	65	70	85
Non-cracked concrete								
Tensile N_{Rk} [kN]	2,4	3,5	3,0	9,5	12,5	16,0	16,4	22,0
Shear V_{Rk} [kN]	2,4	3,5	6,5	9,8*	12,5	16,6	16,8	29,1*
Cracked concrete								
Tensile N_{Rk} [kN]	NA	NA	3,0	4,5	6,2	8,0	10,5	14,0
Shear V_{Rk} [kN]	NA	NA	6,5	9,5	8,7	11,6	11,7	33,2

* Failure mode = steel

Design resistances

Anchor size	S-CSA 5		S-CSA 6		S-CSA 8		S-CSA 10	
Approval	-	-	PART6	OPT1	-	OPT1	-	OPT1
Effective anchorage depth h_{ef} [mm]	19,0	27,5	31,9	42,5	40,0	48,5	48,8	61,5
Nominal anchorage depth h_{nom} [mm]	35	45	40	55	55	65	70	85
Non-cracked concrete								
Tensile N_{Rd} [kN]	1,6	2,3	2,0	6,3	8,3	10,7	10,9	14,7
Shear V_{Rd} [kN]	1,6	2,3	4,3	7,8*	8,3	11,1	11,2	23,3*
Cracked concrete								
Tensile N_{Rd} [kN]	NA	NA	2,0	3,0	4,2	5,3	7,0	9,3
Shear V_{Rd} [kN]	NA	NA	4,3	6,3	5,8	7,7	7,8	22,1

* Failure mode = steel

Recommended loads

Anchor size	S-CSA 5		S-CSA 6		S-CSA 8		S-CSA 10	
Approval	-	-	PART6	OPT1	-	OPT1	-	OPT1
Effective anchorage depth h_{ef} [mm]	19,0	27,5	31,9	42,5	40,0	48,5	48,8	61,5
Nominal anchorage depth h_{nom} [mm]	35	45	40	55	55	65	70	85
Non-cracked concrete								
Tensile N_{Rec} [kN]	1,1	1,7	1,4	4,5	5,9	7,6	7,8	10,5
Shear V_{Rec} [kN]	1,1	1,7	3,1	5,6*	5,9	7,9	8,0	16,6*
Cracked concrete								
Tensile N_{Rec} [kN]	NA	NA	1,4	2,1	3,0	3,8	5,0	6,7
Shear V_{Rec} [kN]	NA	NA	3,1	4,5	4,2	5,5	5,6	15,8

* Failure mode = steel

The partial safety factor for action is $\gamma = 1.4$.

BASIC LOADING DATA FOR PRECAST PRE-STRESSED HOLLOW CORE SLABS

The data of these tables is based on:

- Concrete C30/37 to C50/60
- Installation has been done correctly (see page 7).
- Edge distances and spacings acc. page 7.
- The data of these tables is based on ETA-17/1009.



Characteristic resistances

Anchor size			S-CSA 6	
Nominal anchorage depth	h_{nom}	[mm]	40	
Flange thickness	d_b	[mm]	≥ 25	≥ 30 ≥ 40
Load for all directions	F_{Rk}	[kN]	1,0	2,0 3,0
Char. bending resistance	$M_{Rk,s}^0$	[Nm]	16,0	
Edge distance	$c_{cr} = c_{min}$	[mm]	100	
Spacing	$s_{cr} = s_{min}$	[mm]	100	

Design resistances

Anchor size			S-CSA 6	
Nominal anchorage depth	h_{nom}	[mm]	40	
Flange thickness	d_b	[mm]	≥ 25	≥ 30 ≥ 40
Load for all directions	F_{Rd}	[kN]	0,7	1,3 2,0
Design bending resistance	$M_{Rd,s}$	[Nm]	12,8	
Edge distance	$c_{cr} = c_{min}$	[mm]	100	
Spacing	$s_{cr} = s_{min}$	[mm]	100	

Recommended loads

Anchor size			S-CSA 6	
Nominal anchorage depth	h_{nom}	[mm]	40	
Flange thickness	d_b	[mm]	≥ 25	≥ 30 ≥ 40
Load for all directions	F_{rec}	[kN]	0,5	1,0 1,4
Rec. bending load	M_{rec}	[Nm]	9,1	
Edge distance	$c_{cr} = c_{min}$	[mm]	100	
Spacing	$s_{cr} = s_{min}$	[mm]	100	

The partial safety factor for action is $\gamma = 1.4$.

Requirements for multiple anchoring

The definition of multiple use according to the Member States is given in annex of the ETAG 001 Part 6.

Minimum number of fixing points	Minimum number of anchors per fixing point	Maximum design load of action N_{sd} per fixing point
3	1	2 kN
4	1	3 kN

The value N_{sd} might be increased if in the design it is shown that the requirements on the strength and stiffness of the fixture in the serviceability and ultimate states after the failure of one anchor are fulfilled.

INSTALLATION INSTRUCTIONS IN PRE-STRESSED HOLLOW CORE SLABS

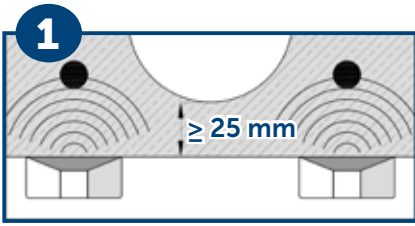

1. Locate rebars by means of suitable detector

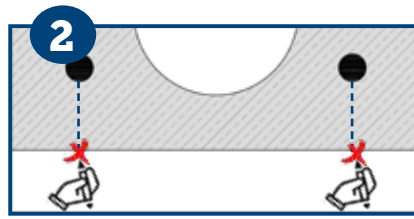

2. Mark rebar location

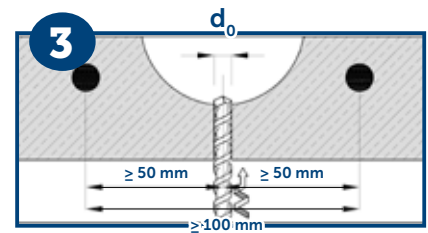

3. Make a cylindrical hole

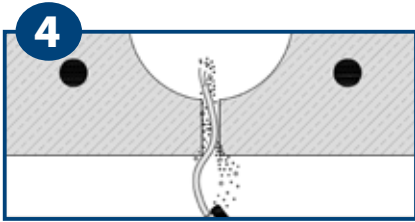

4. Clean the hole

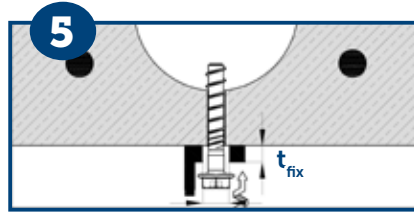

5. Install the screw anchor very gently by screwdriver or torque wrench. Avoid overtightening.

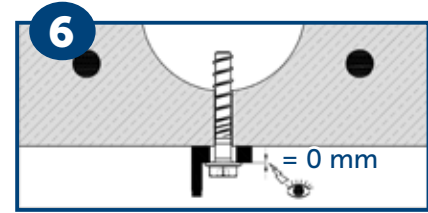

6. Ensure that the screw anchor head fully rests without any gap on the fixture and is not damaged

Admissible anchor position in pre-stressed hollow core slabs

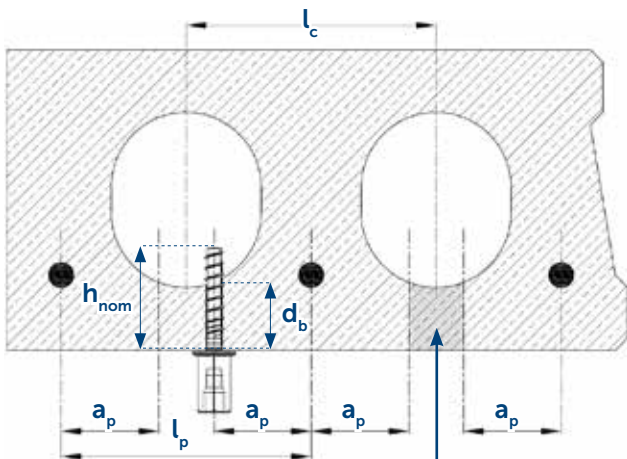

o Admissible anchor position

- Core distance $l_c \geq 100 \text{ mm}$
- Prestressing steel distance $l_p \geq 100 \text{ mm}$
- Distance between anchor position and prestressing steel $a_p \geq 50 \text{ mm}$

Minimum spacing and edge distance of anchors and distance between anchor groups in pre-stressed hollow core slabs



- Minimum edge distance $c_{min} \geq 100 \text{ mm}$
- Minimum anchor spacing $s_{min} \geq 100 \text{ mm}$
- Minimum distance between anchor groups $a_{min} \geq 100 \text{ mm}$

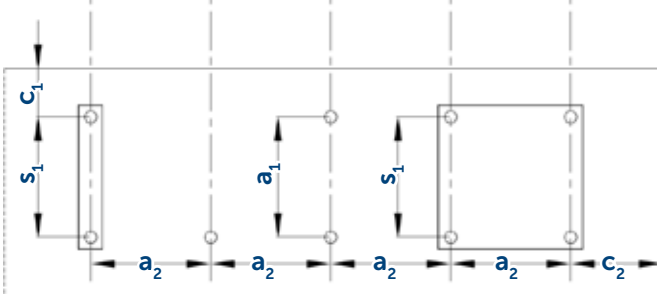

- c1, c2 edge distance
- s1, s2 anchor spacing
- a1, a2 distance between anchor groups

FIRE RESISTANCE

Design under fire exposure is performed according to the design method given in EOTA TR 020.



The data of these tables is based on: ETA-16/0945 and ETA-17/1009

- Concrete C20/25, $f_{ck,cube} = 25 \text{ N/mm}^2$
- Values cannot be used with hollow core slabs
- Installation has been done correctly (p.10)
- No influence of edge distances and spacings (p. 11)
- Respect of minimum base material thickness (p. 11)

Characteristic resistances

Anchor size	S-CSA 6		S-CSA 8	S-CSA 10
	PART 6	OPT 1	OPT 1	OPT 1
Approval				
Effective anchorage depth h_{ef} [mm]	31,9	42,5	48,5	61,5
Nominal anchorage depth h_{nom} [mm]	40	55	65	85
Fire Exposure R30				
Tensile $N_{Rk, s, fi}$ [kN]	0,24	0,24	0,42	1,02
Shear (steel failure) $V_{Rk, s, fi}$ [kN]	0,24	0,24	0,42	1,02
Fire Exposure R120				
Tensile $N_{Rk, s, fi}$ [kN]	0,12	0,12	0,21	0,54
Shear (steel failure) $V_{Rk, s, fi}$ [kN]	0,12	0,12	0,21	0,54

Design resistances

Anchor size	S-CSA 6		S-CSA 8	S-CSA 10
	PART 6	OPT 1	OPT 1	OPT 1
Approval				
Effective anchorage depth h_{ef} [mm]	31,9	42,5	48,5	61,5
Nominal anchorage depth h_{nom} [mm]	40	55	65	85
Fire Exposure R30				
Tensile N_{Rd} [kN]	0,24	0,24	0,42	1,02
Shear V_{Rd} [kN]	0,24	0,24	0,42	1,02
Fire Exposure R120				
Tensile N_{Rd} [kN]	0,12	0,12	0,21	0,54
Shear V_{Rd} [kN]	0,12	0,12	0,21	0,54

Recommended loads

Anchor size	S-CSA 6		S-CSA 8	S-CSA 10
	PART 6	OPT 1	OPT 1	OPT 1
Approval				
Effective anchorage depth h_{ef} [mm]	31,9	42,5	48,5	61,5
Nominal anchorage depth h_{nom} [mm]	40	55	65	85
Fire Exposure R30				
Tensile N_{rec} [kN]	0,24	0,24	0,42	1,02
Shear V_{rec} [kN]	0,24	0,24	0,42	1,02
Fire Exposure R120				
Tensile N_{rec} [kN]	0,12	0,12	0,21	0,54
Shear V_{rec} [kN]	0,12	0,12	0,21	0,54

The recommended loads under fire exposure include a safety factor for resistance under fire exposure $\gamma_{M,fi} = 1,0$ and the partial safety factor for action $\gamma_{F,fi} = 1,0$. The partial safety factors for action shall be taken from national regulations.

MATERIALS AND DIMENSIONS

Material quality and coating

Part	
Material	Cold forged carbon steel
Coating ZP	Zinc electroplated according to EN ISO 4042 $\geq 5 \mu\text{m}$
Coating ML	Multi Layer coating $\geq 8 \mu\text{m}$

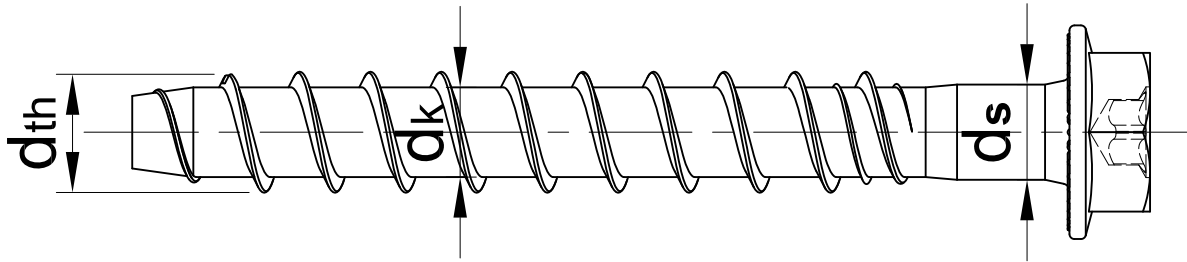

Mechanical properties

Specification		S-CSA 5	S-CSA 6	S-CSA 8	S-CSA 10
Nominal tensile strength F_{uk}	[N/mm ²]	800	800	800	800
Char. bending resistance $M_{Rk,s}^0$	[Nm]	8,6	16	37	76
Design bending resistance $M_{Rd,s}$	[Nm]	5,7	12,8	29,6	60,8
Recommended bending resistance M_{rec}	[Nm]	4,1	9,1	21,1	43,4

Specification		S-CSA 5	S-CSA 6	S-CSA 8	S-CSA 10	
Nominal diameter	d_{nom}	[mm]	5,0	6,0	8,0	10,0
Thread outer diameter	d_{th}	[mm]	6,12	7,45	9,9	11,9
Core diameter	d_k	[mm]	4,50	5,55	7,35	9,3
Shaft diameter	d_s	[mm]	4,9	5,88	7,8	9,6
Stressed section	A_s	[mm]	15,9	23,76	41,85	67,9

INSTALLATION INSTRUCTIONS

Installation equipment

Specification	S-CSA 5	S-CSA 6	S-CSA 8	S-CSA 10
Rotary hammer	750...1200 r.p.m / 1.8 ...3.3 J			
Drill bit	SDS+ 2-CUT or 4-CUT sizes 5, 6, 8, 10 mm			
Socket (SW)	8 mm	13 mm	13 mm	15 mm
Additional tools	air pump/compressor, torque wrench, impact screw driver			

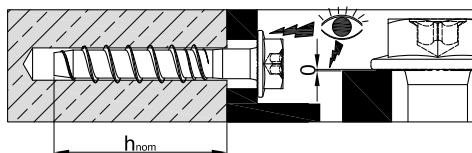
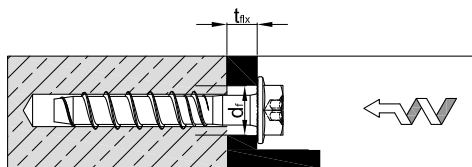
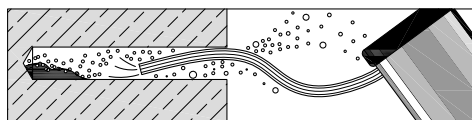
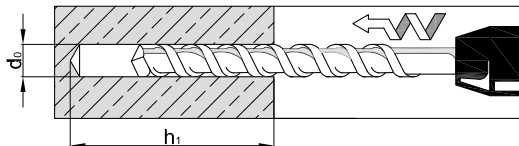

NOTES:

CONCRETE AND HOLLOW CORE SLAB

- Concrete strength is C20/25 to C50/60
Hollow core slabs C30/37 to C50/60
- No significant voids in concrete.
- Concrete is well compacted.
- Thickness of concrete is according PDS installation data (see page 11).

INSTALLATION (see page 10-11)

- Edge distances and spacing are according PDS installation data.
- Use proper air pump or compressor.
- Drill hole is deep enough (mentioned h_1 in PDS installation data).
- All dust should be cleaned from the hole to avoid screw jamming during installation.
- Pay special attention to cleaning, especially when installing downwards.
- In case of aborted hole, drilling of new hole at a minimum distance of twice the depth of the aborted hole, or smaller distance provided the aborted drill hole is filled with high strength non-shrinkage mortar. No shear or oblique tension loads are allowed in the direction of a not filled aborted hole.

OTHER BASE MATERIALS

- Concrete screw can be used also in other base materials such as clay brick and solid sand-lime brick.

Installation data

Specification			S-CSA 5		S-CSA 6		S-CSA 8		S-CSA 10	
Approval			-	-	PART 6	OPT 1	-	OPT 1	-	OPT1
Drill hole diameter	d_0	[mm]	5		6		8		10	
Cutting diameter at the upper tolerance limit (max. diam. bit)	$d_{cut,max \leq}$	[mm]	5,40		6,40		8,45		10,45	
Depth of drilled hole to deepest point	$h_{1 \geq}$	[mm]	45	55	50	65	65	75	80	95
Effective anchorage depth	h_{ef}	[mm]	19,0	27,5	31,9	42,5	40,0	48,5	48,8	61,5
Nominal anchorage depth	h_{nom}	[mm]	35	45	40	55	55	65	70	85
Diameter of clearance hole in the fixture	$d_{f \geq}$	[mm]	7		9		12		14	
Max. torque	T_{inst}	[Nm]	12		14		40		90	
Width across flats	SW	[mm]	8		13		13		15	
T-drive (in types HEX and CS)	T-drive		HEX	NA	T30		T40		NA	
			CS	T25						

S-CSA ANCHOR INSTALLATION

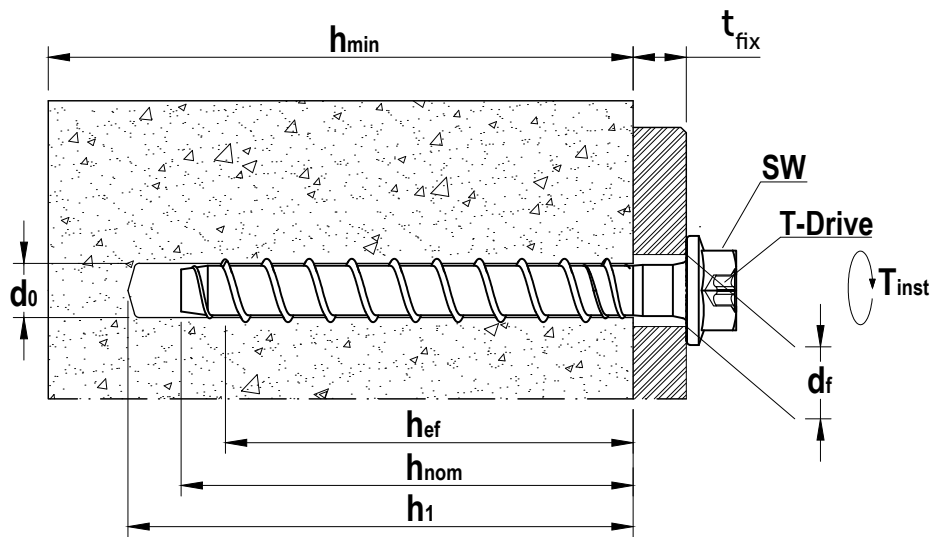

Minimum thickness of concrete member, spacing and edge distance

Cracked and non-cracked concrete			S-CSA 5		S-CSA 6		S-CSA 8		S-CSA 10	
Approval			-	-	PART 6	OPT 1	-	OPT 1	-	OPT1
Effective anchorage depth	h_{ef}	[mm]	19,0	27,5	31,9	42,5	40,0	48,5	48,8	61,5
Nominal anchorage depth	h_{nom}	[mm]	35	45	40	55	55	65	70	85
Minimum thickness of base material	h_{min}	[mm]	80	80	100	100	110	110	125	125
Minimum spacing	s_{min}	[mm]	35	35	35	35	50	50	50	50
Minimum edge distance	c_{min}	[mm]	35	35	35	35	50	50	50	50
	$s_{cr,sp}$	[mm]	53	83	96	128	120	146	146	184
Critical spacing for splitting failure and concrete cone failure (in case characteristic loading affects)	$s_{cr,N}$	[mm]	53	83	96	128	120	146	146	184
	$c_{cr,sp}$	[mm]	27	41	48	64	60	73	73	92
Critical edge distance for splitting failure and concrete cone failure (in case characteristic loading affects)	$c_{cr,N}$	[mm]	27	41	48	64	60	73	73	92

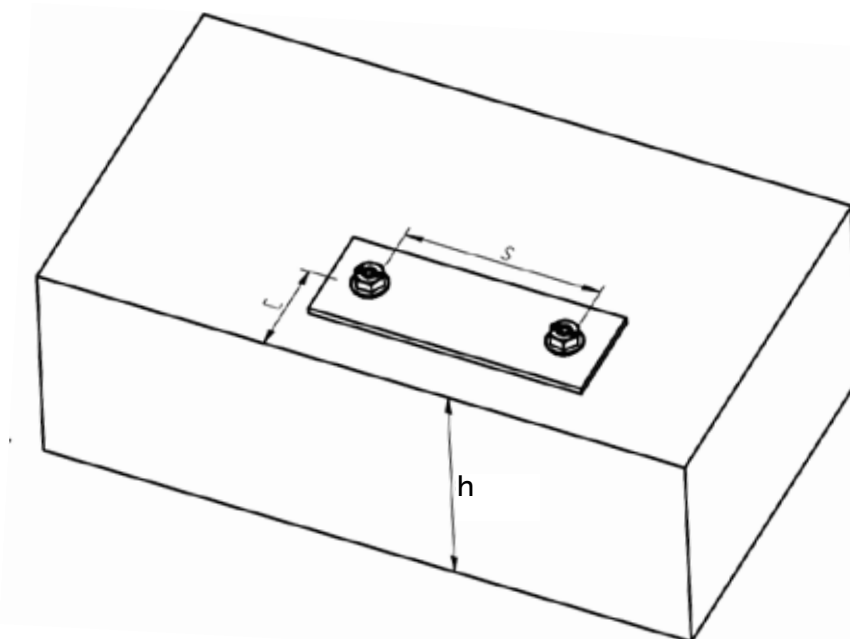

S-CSA HEX, S-CSA CS, S-CSA I, S-CSA P CONCRETE SCREW

Delivery program



Size	Type	t _{fix}	Length	S-CSA HEX	S-CSA CS	S-CSA P	S-CSA I
S-CSA 5	5x40/5	5	40	■ (ZP only)			
	5x50/5	5	50	■ (ZP only)	■ (ZP only)		
	5x75/30	30	75		■ (ZP only)		
	5x100/55	55	100		■ (ZP only)		
S-CSA 6	6x45/5	5	45	●		●	
	6x45 M8/M10		45				●
	6x50/10	10	50	●			
	6x60/5/20	5/20	60	● ●	● ●	● ●	
	6x60 M8/M10		60				● ●
	6x80/25/40	25/40	80	● ●	● ●		
6x100/45/60	45/60	100	● ●	● ●			
S-CSA 8	8x60/5	5	60	■			
	8x70/5(15)	5(15)	70	●			
	8x80/15(25)	15(25)	80	●			
	8x100/35(45)	35(45)	100	●			
	8x120/55(65)	55(65)	120	●			
S-CSA 10	10x80/10	10	80	■			
	10x90/5(20)	5(20)	90	●			
	10x100/15(30)	15(30)	100	●			
	10x120/35(50)	35(50)	120	●			
	10x140/55(70)	55(70)	140	●			

- Option 1
- Part 6
- No ETA