

This is a sample photo.

ORDER SYMBOL: PC F 85 G

EL.number **EAN:** 6418074002211
 Sweden: 2536823
 Denmark: 8212001637
 Finland: 3423415

INCLUDING:
 Enclosure body, cover with PUR gasket, 4 cover screws, and mounting screws.

APPROVALS:
 USA: UL Type 1, 4X, 12, 13 (E75645 Vol.1 Sec.3); UL 94-V2
 EURO: IP 67; UL 94-V2
 OTHERS: IEC 529, CE, EEI, FIMKO 197844-01, GL 94 513 HH, LR 90/00200 (E4), CSA LR 49336-8

FIBOX PICCOLO PC

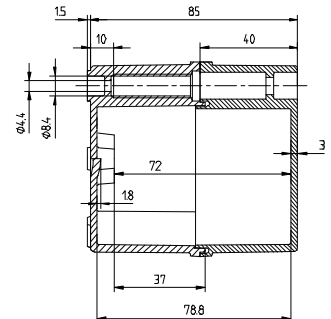
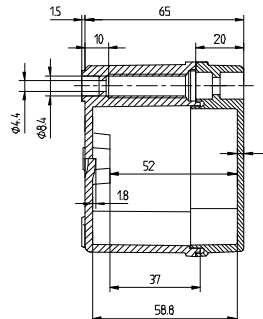
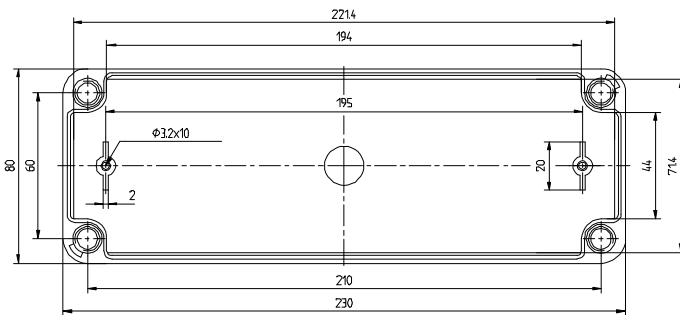

TECHNICAL INFORMATION:

Standard colour: RAL 7035
 Ingress protection: IP 67 (IEC 529)
 Flame resistance: UL 94-V2

Temp.range in cont. use: Max. +80 °C
 Temp. range of material: - 40 °C - + 120 °C

ACCESSORIES

DIN-Rail	B-1	Fastening lug	FP 22040
DIN-Rail	B-3	Fastening lug	FP 22046
DIN-Rail	CHM-1	Screw	MB S-20KN
DIN-Rail	CHM-3	Screw	MB S-40KN
DIN-Rail	DH-1		
DIN-Rail	DH-3		
DIN-Rail	FM-1		
DIN-Rail	FM-3		