

ebm-papst Mulfingen GmbH & Co. KG

Bachmühle 2 · D-74673 Mulfingen

Phone +49 7938 81-0

Fax +49 7938 81-110

info1@de.ebmpapst.com

www.ebmpapst.com

Limited partnership · Headquarters Mulfingen

Amtsgericht (court of registration) Stuttgart · HRA 590344

General partner Elektrobau Mulfingen GmbH · Headquarters Mulfingen

Amtsgericht (court of registration) Stuttgart · HRB 590142

**Nominal data**

Type	K3G900-AS08-01	
Motor	M3G200-QA	
Phase		3~
Nominal voltage	VAC	400
Nominal voltage range	VAC	380 .. 480
Frequency	Hz	50/60
Method of obtaining data		ml
Speed	min ⁻¹	1050
Power consumption	W	8700
Current draw	A	13.5
Min. ambient temperature	°C	-25
Max. ambient temperature	°C	40

ml = Max. load · me = Max. efficiency · fa = Free air · cs = Customer specification · ce = Customer equipment
Subject to change

Data according to ErP Directive

		Actual	Req. 2015			
01 Overall efficiency η_{es}	%	64.3	61.4	09 Power consumption P_{ed}	kW	8.68
02 Measurement category		A		09 Air flow q_v	m ³ /h	21530
03 Efficiency category		Static		09 Pressure increase p_{fs}	Pa	899
04 Efficiency grade N		64.9	62	10 Speed n	min ⁻¹	1045
05 Variable speed drive		Yes		11 Specific ratio [*]		1.01

Data obtained at optimum efficiency level.

The ErP data is determined using a motor-impeller combination in a standardized measurement setup.

^{*} Specific ratio = $1 + p_{fs} / 100\,000\text{ Pa}$

LU-146118



Technical description

Weight	220 kg
Fan size	900 mm
Rotor surface	Painted black
Electronics housing material	Die-cast aluminum, painted black
Impeller material	Sheet aluminum
Inlet nozzle material	Sheet steel, galvanized and coated with light gray plastic (RAL 7035)
Support structure material	Sheet steel, galvanized and coated with light gray plastic (RAL 7035)
Number of blades	7
Direction of rotation	Clockwise, viewed toward rotor
Degree of protection	IP54
Insulation class	"F"
Moisture (F) / Environmental (H) protection class	F4-1
Ambient temperature note	Occasional start-up between -40°C and -25°C is permissible. For continuous operation at temperatures below -25°C (e.g. refrigeration applications) we recommend our fan design with special low-temperature bearings.
Max. permitted ambient temp. for motor (transport/storage)	+80 °C
Min. permitted ambient temp. for motor (transport/storage)	-40 °C
Installation position	Shaft horizontal (base mounting only) or rotor on bottom; rotor on top on request
Condensation drainage holes	On rotor side
Mode	S1
Motor bearing	Ball bearing
Technical features	<ul style="list-style-type: none"> - Output 10 VDC, max. 10 mA - Output 20 VDC, max. 50 mA - Output for slave 0-10 V - Input for sensor 0-10 V or 4-20 mA - External 24 V input (parameter setting) - Alarm relay - Integrated PID controller - Motor current limitation - PFC, passive - RS-485 MODBUS-RTU - Soft start - Control input 0-10 VDC / PWM - Control interface with SELV potential safely disconnected from supply - Thermal overload protection for electronics/motor - Line undervoltage / phase failure detection
Touch current according to IEC 60990 (measuring circuit Fig. 4, TN system)	<= 3.5 mA
Electrical hookup	Via terminal box
Motor protection	Reverse polarity and locked-rotor protection
Protection class	I (with customer connection of protective earth)
Conformity with standards	EN 61800-5-1
Approval	EAC; UL 1004-7 + 60730; C22.2 No.77 + CAN/CSA-E60730-1

EC centrifugal module - RadiPac

backward-curved, single-intake
with cube design

Product drawing

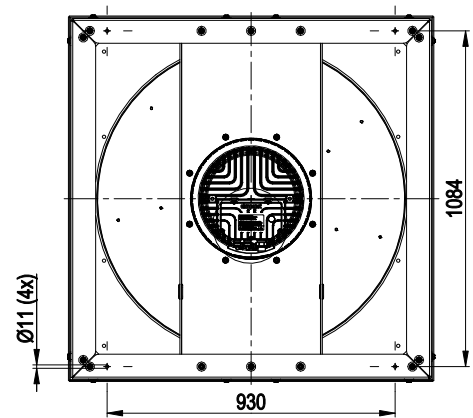
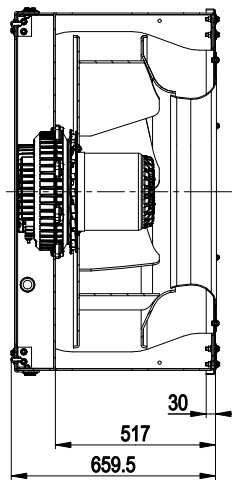
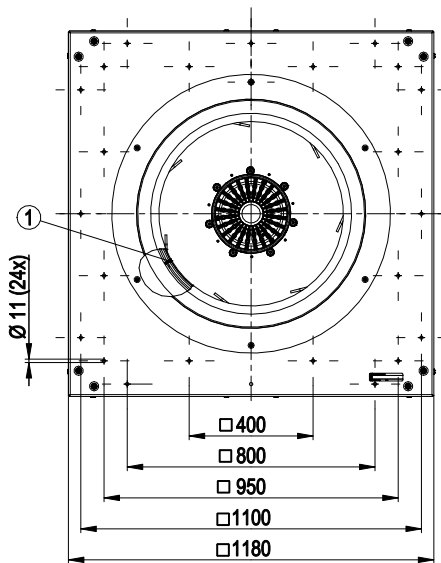
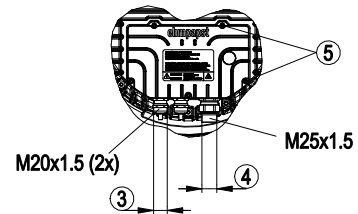
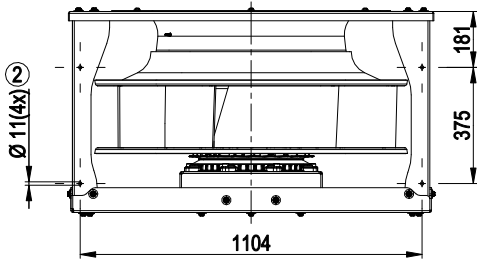

1	Inlet ring with pressure tap (k-factor: 900)
2	Mounting position for vibration-absorbing elements
3	Cable diameter min. 5 mm, max. 13 mm; tightening torque 6 ± 0.9 Nm
4	Cable diameter min. 16 mm, max. 20.5 mm, tightening torque 6 ± 0.9 Nm
5	Tightening torque 3.5 ± 0.5 Nm

Connection diagram

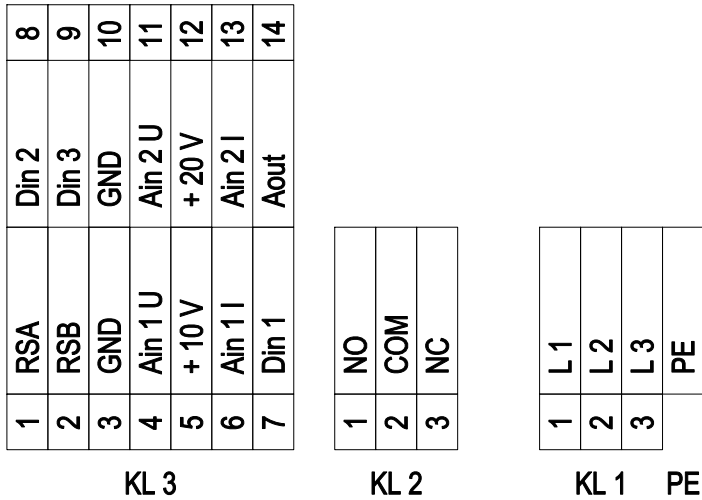

No.	Conn.	Designation	Function/assignment
KL 1	1	L1	Supply connection, power supply 3-phase 380-480 VAC, 50/60 Hz
KL 1	2	L2	Supply connection, power supply 3-phase 380-480 VAC, 50/60 Hz
KL 1	3	L3	Supply connection, power supply 3-phase 380-480 VAC, 50/60 Hz
PE		PE	Ground connection, PE connection
KL 2	1	NO	Status relay, floating status contact, make for failure
KL2	2	COM	Status relay, floating status contact; changeover contact; common connection; contact rating 250 VAC / max. 2 A (AC1) / min. 10 mA
KL2	3	NC	Status relay, floating status contact, break for failure
KL 3	1	RSA	Bus connection RS485, RSA, MODBUS RTU
KL 3	2	RSB	Bus connection RS485, RSA, MODBUS RTU
KL 3	3 / 10	GND	Reference ground for control interface
KL 3	4	Ain1 U	Analog input 1 (set value), 0-10 V, Ri = 100 kΩ, adjustable curves, only usable as alternative to input Ain1I
KL 3	5	+ 10 V	Fixed voltage output 10 VDC, +10 V ±3%; max. 10 mA; short-circuit-proof; power supply for external devices (e.g. pot)
KL 3	6	Ain1 I	Analog input 1 (set value), 4-20 mA, Ri = 100 Ω, adjustable curves, only usable as alternative to input Ain1U
KL 3	7	Din1	Digital input 1: enable electronics, enable: pin open or applied voltage 5...50 VDC; disable: bridge to GND or applied voltage < 1 VDC; reset function: triggers software reset after a level change to < 1 V
KL 3	8	Din2	Digital input 2: Switching parameter sets 1/2; according to EEPROM setting, the valid or used parameter set can be selected via bus or via digital input DIN2. Parameter set 1: pin open or applied voltage 5-50 VDC; parameter set 2: bridge to GND or applied voltage < 1 VDC
KL 3	9	Din3	Digital input 3: according to EEPROM setting, the integrated controller's direction of action can be selected as normal/inverse via bus or digital input; normal: pin open or applied voltage 5-50 VDC inverse: bridge to GND or applied voltage < 1 VDC
KL 3	11	Ain2 U	Analog input 2, measured value 0-10 V, Ri = 100 kΩ, adjustable curve, only usable as alternative to input Ain2I
KL 3	12	+ 20 V	Fixed voltage output 20 VDC, 20 V +25/-10%, max. 50 mA, short-circuit-proof power supply for external devices (e.g. sensors)
KL 3	13	Ain2 I	Analog input 2, measured value: 4-20 mA, Ri = 100 Ω, adjustable curve, only usable as alternative to input Ain2U
KL 3	14	Aout	Analog output 0-10 V, max. 5 mA, output of current motor modulation level / of the current motor speed. Adjustable curve.

Curves: Air performance 50 Hz

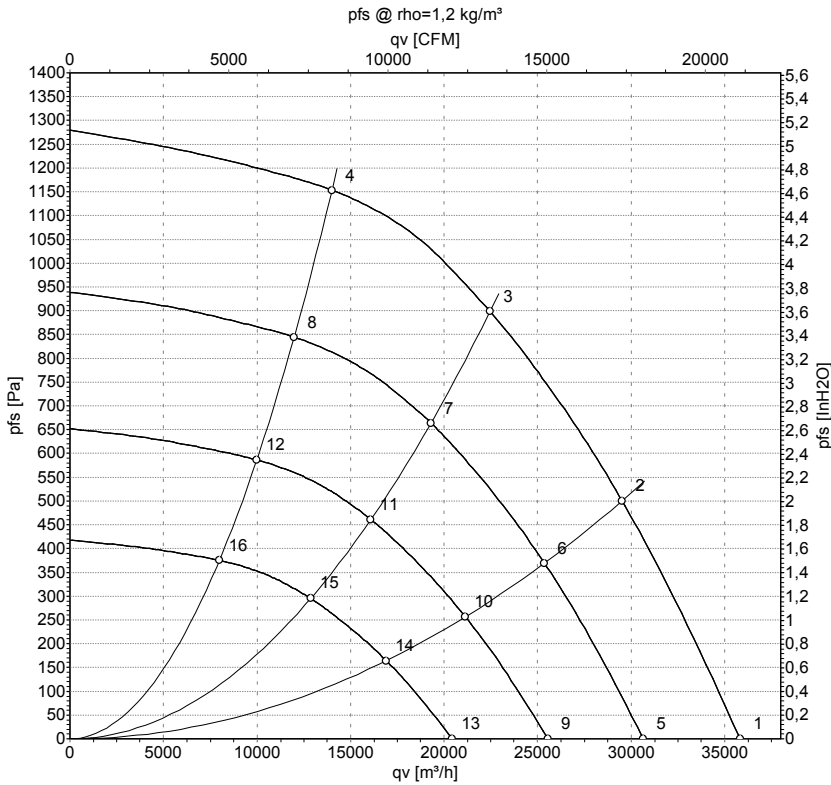

Measurement: LU-146118

Air performance measured according to ISO 5801 installation category A. For detailed information on the measurement setup, contact ebm-papst. Intake sound level: Sound power level according to ISO 13347 / sound pressure level measured at 1 m distance from fan axis. The values given are valid under the specified measuring conditions and may vary due to conditions of installation. For deviations from the standard configuration, the parameters have to be checked on the installed unit.

Measured values

	U	f	n	P _{ed}	I	LpA _{in}	LwA _{in}	LwA _{out}	qv	P _{fs}
	V	Hz	min ⁻¹	W	A	dB(A)	dB(A)	dB(A)	m ³ /h	Pa
1	400	50	1050	5307	8.44	90	99	102	35820	0
2	400	50	1050	7478	11.61	82	90	95	29520	500
3	400	50	1050	8700	13.50	78	86	90	22450	900
4	400	50	1050	8037	12.41	79	87	91	14005	1150
5	400	50	900	3323	5.29	86	95	98	30645	0
6	400	50	900	4746	7.37	78	87	91	25370	371
7	400	50	900	5486	8.46	74	82	86	19300	664
8	400	50	900	5034	7.77	75	83	87	11985	847
9	400	50	750	1923	3.06	82	90	94	25540	0
10	400	50	750	2747	4.26	73	82	86	21140	257
11	400	50	750	3175	4.90	69	78	82	16080	461
12	400	50	750	2913	4.50	70	79	83	9985	588
13	400	50	600	985	1.57	76	84	88	20430	0
14	400	50	600	1406	2.18	68	76	81	16915	165
15	400	50	600	1626	2.51	64	72	76	12865	295
16	400	50	600	1492	2.30	65	73	77	7990	376

U = Power supply · f = Frequency · n = Speed · P_{ed} = Power consumption · I = Current draw · LpA_{in} = Sound pressure level intake side · LwA_{in} = Sound power level intake side
 LwA_{out} = Sound power level outlet side · qv = Air flow · p_{fs} = Pressure increase

