

ESSKV 50 EMV-Z

EMC-cable gland, stainless steel

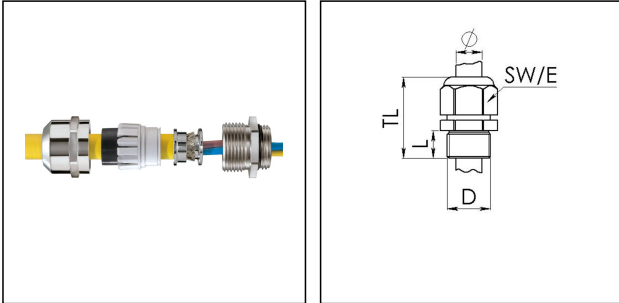

Product illustrations are exemplary and may differ from the chosen product. Further variants and individual customization, we will gladly provide you on request.



Material cable gland	Stainless steel A2 (1.4305)
Material sealing gasket	EPDM
Material clamping cage	Polyamide
Material earthing insert	Brass chromium-plated
Temp. range min	-40 °C
Temp. range max	100 °C
Intermittent temp. range	120 °C
Protection class	IP 68, 5 bar 30 min, IP 69K
Thread type	M
Connection thread size D	50
Lead	1,5
Length screw-in thread L	9 mm
Cable diameter min	21 mm
Cable diameter max	35 mm
Cable Diam. below cable shield	33 mm
Cable Diameter UL	24,3 mm - 33,4 mm
Key width SW	55 mm
Collar diameter (E)	61 mm
Total length TL	51 mm - 62 mm
Type	ESSKV 50 EMV-Z
ETIM-Classification	EC000441
Packing unit	2

Recommended accessories

RDE 50	10062188
BS 25	10064015
BS 35	10064017
ESMU 50	10064194

19.11.2014