

ESSKV 32 EMV-Z

EMC-cable gland, stainless steel

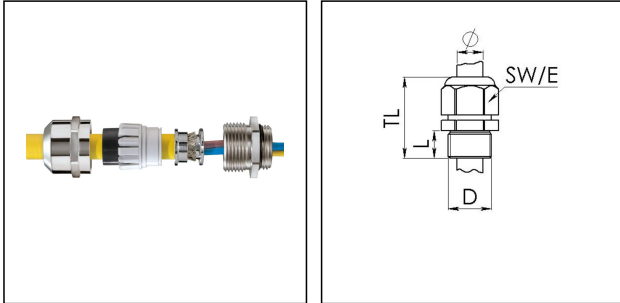

Product illustrations are exemplary and may differ from the chosen product. Further variants and individual customization, we will gladly provide you on request.



Material cable gland	Stainless steel A2 (1.4305)
Material sealing gasket	EPDM
Material clamping cage	Polyamide
Material earthing insert	Brass chromium-plated
Temp. range min	-40 °C
Temp. range max	100 °C
Intermittent temp. range	120 °C
Protection class	IP 68, 5 bar 30 min, IP 69K
Thread type	M
Connection thread size D	32
Lead	1,5
Length screw-in thread L	8 mm
Cable diameter min	13 mm
Cable diameter max	21 mm
Cable Diam. below cable shield	20 mm
Cable Diameter UL	14,6 mm - 19,5 mm
Key width SW	36 mm
Collar diameter (E)	40 mm
Total length TL	36 mm - 44 mm
Type	ESSKV 32 EMV-Z
ETIM-Classification	EC000441
Packing unit	5

Recommended accessories

RDE 32	10062186
BS 14	10064011
BS 21	10064014
ESMU 32	10064192

19.11.2014