

ESSKV 25 EMV-Z

EMC-cable gland, stainless steel

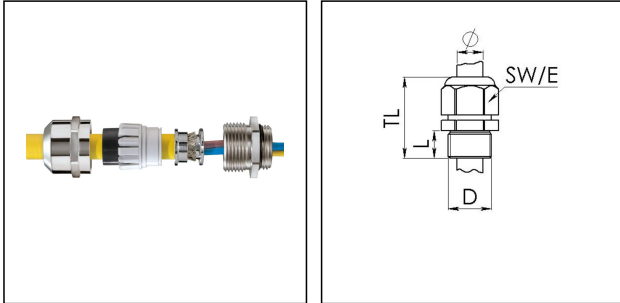

Product illustrations are exemplary and may differ from the chosen product. Further variants and individual customization, we will gladly provide you on request.



Material cable gland	Stainless steel A2 (1.4305)
Material sealing gasket	EPDM
Material clamping cage	Polyamide
Material earthing insert	Brass chromium-plated
Temp. range min	-40 °C
Temp. range max	100 °C
Intermittent temp. range	120 °C
Protection class	IP 68, 5 bar 30 min, IP 69K
Thread type	M
Connection thread size D	25
Lead	1,5
Length screw-in thread L	7 mm
Cable diameter min	9 mm
Cable diameter max	17 mm
Cable Diam. below cable shield	16 mm
Cable Diameter UL	10,8 mm - 15,8 mm
Key width SW	30 mm
Collar diameter (E)	33 mm
Total length TL	33 mm - 42 mm
Type	ESSKV 25 EMV-Z
ETIM-Classification	EC000441
Packing unit	10

Recommended accessories

RDE 25	10060768
BS 12	10064009
BS 17	10064012
ESMU 25	10064191

19.11.2014