

MSKV 48

Cable gland, brass

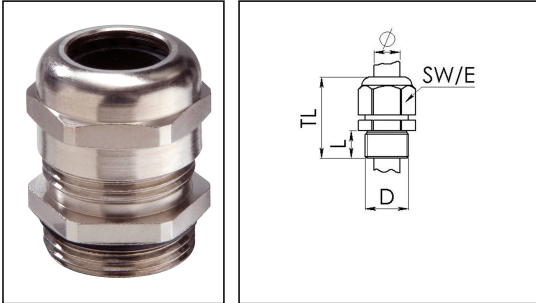

Product illustrations are exemplary and may differ from the chosen product. Further variants and individual customization, we will gladly provide you on request.



Material cable gland	Brass nickel-plated
Material clamping cage	Polyamide
Material sealing gasket	TPV
Temp. range min	-40 °C
Temp. range max	100 °C
Intermittent temp. range	120 °C
Protection class	IP 68, 5 bar 30 min, IP 69K
Thread type	PG
Connection thread size D	48
Length screw-in thread L	14 mm
Cable diameter min	34 mm
Cable diameter max	44 mm
Key width SW	64 mm
Collar diameter (E)	69 mm
Total length TL	52 mm
Impact category	6
Surface	Nickel-plated
Order no. nickel-plated	10062290
Type	MSKV 48
Packing unit	10
ETIM-Classification	EC000441

Recommended accessories

19.11.2014