

## MSKV 29

Cable gland, brass

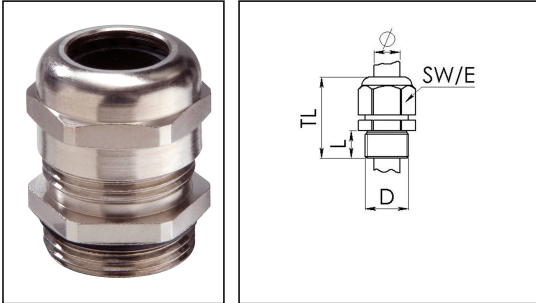

Product illustrations are exemplary and may differ from the chosen product. Further variants and individual customization, we will gladly provide you on request.



<b>Material cable gland</b>	Brass nickel-plated
<b>Material clamping cage</b>	Polyamide
<b>Material sealing gasket</b>	TPV
<b>Temp. range min</b>	-40 °C
<b>Temp. range max</b>	100 °C
<b>Intermittent temp. range</b>	120 °C
<b>Protection class</b>	IP 68, 5 bar 30 min, IP 69K
<b>Thread type</b>	PG
<b>Connection thread size D</b>	29
<b>Length screw-in thread L</b>	8 mm
<b>Cable diameter min</b>	18 mm
<b>Cable diameter max</b>	25 mm
<b>Key width SW</b>	40 mm
<b>Collar diameter (E)</b>	44 mm
<b>Total length TL</b>	39 mm
<b>Impact category</b>	6
<b>Surface</b>	Nickel-plated
<b>Order no. nickel-plated</b>	10062287
<b>Type</b>	MSKV 29
<b>Packing unit</b>	25
<b>ETIM-Classification</b>	EC000441

Recommended accessories

19.11.2014