

INSTALLATION MANUAL

Four-way Cassette Type

Thank you very much for purchasing our air conditioner,
Before using your air conditioner, please read this manual carefully and keep it for future reference.

CONTENTS

PAGE

PRECAUTIONS.....1

INSTALLATION INFORMATION.....2

INSPECTING AND HANDLING THE UNIT.....2

ATTACHED FITTINGS.....3

INDOOR UNIT INSTALLATION.....4

INSTALL THE CONNECTING PIPE.....6

REFRIGERANT PIPE CONNECTION.....7

CONNECT THE DRAIN PIPE.....8

WIRING.....9

CONTROL.....10

TROUBLE SHOOTING.....12

TEST OPERATION.....12

1. PRECAUTIONS

- Be sure to be in conformity with the local, national and international laws and regulations.
- Read "PRECAUTIONS" carefully before installation.
- The following precautions include important safety items. Observe them and never forget.
- Keep this manual with the owner's manual in a handy place for future reference.

The safety precautions listed here are divided into two categories. In either case, important safety information is listed which must be read carefully.



WARNING

Failure to observe a warning may result in death.



CAUTION

Failure to observe a caution may result in injury or damage to the equipment.

After completing the installation, make sure that the unit operates properly during the start-up operation. Please instruct the customer on how to operate the unit and keep it maintained. Also, inform customers that they should store this installation manual along with the owner's manual for future reference.



WARNING

Be sure only trained and qualified service personnel to install, repair or service the equipment.

Improper installation, repair, and maintenance may result in electric shocks, short-circuit, leaks, fire or other damage to the equipment.

Install according to this installation instructions strictly. If installation is defective, it will cause water leakage, electrical shock and fire.

When installing the unit in a small room, take measures against to keep refrigerant concentration from exceeding allowable safety limits in the event of refrigerant leakage. Contact the place of purchase for information. Excessive refrigerant in a closed ambient can lead to oxygen deficiency.

Use the attached accessories parts and specified parts for installation.

otherwise, it will cause the set to fall, water leakage, electrical shock fire.

Install at a strong and firm location which is able to withstand the set's weight.

If the strength is not enough or installation is not properly done, the set will drop to cause injury.

The appliance must be installed 2.3m above floor.

The appliance shall not be installed in the laundry.

Before obtaining access to terminals, all supply circuits must be disconnected.

The appliance must be positioned so that the plug is accessible.

The enclosure of the appliance shall be marked by word, or by symbols, with the direction of the fluid flow.

For electrical work, follow the local national wiring standard, regulation and this installation instructions. An independent circuit and single outlet must be used.

If electrical circuit capacity is not enough or defect in electrical work, it will cause electrical shock and fire.

Use the specified cable and connect tightly and clamp the cable so that no external force will be acted on the terminal.

If connection or fixing is not perfect, it will cause heat-up or fire at the connection.

Wiring routing must be properly arranged so that control board cover is fixed properly.

If control board cover is not fixed perfectly, it will cause heat-up at connection point of terminal, fire or electrical shock.

If the supply cord is damaged, it must be replaced by the manufacture or its service agent or a similarly qualified person in order to avoid a hazard.

An all-pole disconnection switch having a contact separation of at least 3mm in all poles should be connected in fixed wiring.

When carrying out piping connection, take care not to let air substances go into refrigeration cycle.

Otherwise, it will cause lower capacity, abnormal high pressure in the refrigeration cycle, explosion and injury.

Do not modify the length of the power supply cord or use of extension cord, and do not share the single outlet with other electrical appliances.

Otherwise, it will cause fire or electrical shock.

The temperature of refrigerant circuit will be high, please keep the interconnection cable away from the copper tube.

Carry out the specified installation work after taking into account strong winds, typhoons or earthquakes.

Improper installation work may result in the equipment falling and causing accidents.

If the refrigerant leaks during installation, ventilate the area immediately.

Toxic gas may be produced if the refrigerant comes into the place contacting with fire.

After completing the installation work, check that the refrigerant does not leak.

Toxic gas may be produced if the refrigerant leaks into the room and comes into contact with a source of fire, such as a fan heater, stove or cooker.



CAUTION

Ground the air conditioner.

Do not connect the ground wire to gas or water pipes, lightning rod or a telephone ground wire. Incomplete grounding may result in electric shocks.

Be sure to install an earth leakage breaker.

Failure to install an earth leakage breaker may result in electric shocks.

Connect the outdoor unit wires, then connect the indoor unit wires.

You are not allowed to connect the air conditioner with the power source until wiring and piping the air conditioner is done.

While following the instructions in this installation manual, install drain piping in order to ensure proper drainage and insulate piping in order to prevent condensation.

Improper drain piping may result in water leakage and property damage.

Install the indoor and outdoor units, power supply wiring and connecting wires at least 1 meter away from televisions or radios in order to prevent image interference or noise.

Depending on the radio waves, a distance of 1 meter may not be sufficient enough to eliminate the noise.

The appliance is not intended for use by young children or infirm persons without supervision.

Don't install the air conditioner in the following locations:

- There is petrolatum existing.
- There is salty air surrounding (near the coast).
- There is caustic gas (the sulfide, for example) existing in the air (near a hot spring).
- The Volt vibrates violently (in the factories).
- In buses or cabinets.
- In kitchen where it is full of oil gas.
- There is strong electromagnetic wave existing.
- There are inflammable materials or gas.
- There is acid or alkaline liquid evaporating.
- Other special conditions.

2. INSTALLATION INFORMATION

To install properly, please read this "installation manual" at first.

The air conditioner must be installed by qualified persons.

When installing the indoor unit or its tubing, please follow this manual as strictly as possible.

If the air conditioner is installed on a metal part of the building, it must be electrically insulated according to the relevant standards to electrical appliances.

When all the installation work is finished, please turn on the power only after a thorough check.

Regret for no further announcement if there is any change of this manual caused by product improvement.



INSTALLATION ORDER

- Select the location;
- Install the indoor unit;
- Install the outdoor unit;
- Install the connecting pipe ;
- Connect the drain pipe;
- Wiring;
- Test operation.

3. INSPECTING AND HANDLING THE UNIT











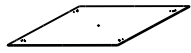

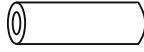
At delivery, the package should be checked and any damage should be reported immediately to the service agent.

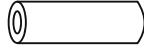
When handling the unit, take into account the following:

- 1  Fragile, handle the unit with care.
 Keep the unit upright in order to avoid compressor damage.
- 2 Choose on before hand the path along which the unit is to be brought in.
- 3 Move this unit as originally package as possible.
- 4 When lifting the unit, always use protectors to prevent belt damage and pay attention to the position of the unit's centre of gravity.

4. ATTACHED FITTINGS

Please check whether the following fittings are of full scope. If there are some spare fittings, please restore them carefully.

	NAME	SHAPE	Four-way Cassette	Four-way Cassette (compact)
INSTALLATION FITTINGS	1. Installation paper board		1	1
	2. Bolt M6		4	—
Tubing & Fittings	3. Soundproof / insulation sheath		2	2
Drainpipe Fittings	4. Out-let pipe pipe		1	1
	5. Out-let pipe sheath		1	—
	6. Out-let pipe clasp		1	1
	7. Tightening band		5	5
Remote controller & Its Frame	8. Remote controller		1	1
	9. Frame		1	1
	10. Mounting screw (ST2.9x10-C-H)		2	2
	11. Alkaline dry batteries (AM4)		2	2
Others	12. Installation manual	This manual	1	1
	13. Signal line	—	1	1
	14. Connective pipe for restriction assembly	—	1	1
	15. Copper nut (Use for pipe connection of engineering installation)		1	1

Cautions on remote controller installation:

- Never throw or beat the controller.
- Before installation, operate the remote controller to determine its location in a reception range.
- Keep the remote controller at least 1m apart from the nearest TV set or stereo equipment. (it is necessary to prevent image disturbances or noise interferences.)
- Do not install the remote controller in a place exposed to direct sunlight or close to a heating source, such as a stove.
- Note that the positive and negative poles are right positions when loading batteries.
- This manual is subject to changes due to technological improvement without further notices.

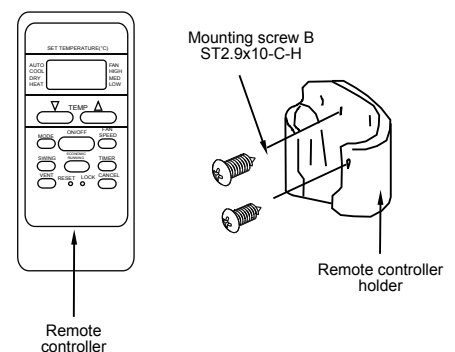

Fig.4-1

5. INDOOR UNIT INSTALLATION

5.1 Installation place

(Refer to Fig.5-1, Fig.5-2, Fig.5-3 for specification.)

The indoor unit should be installed in a location that meets the following requirements:

- There is enough room for installation and maintenance.
- The ceiling is horizontal, and its structure can endure the weight of the indoor unit.
- The outlet and the inlet are not impeded, and the influence of external air is the least.
- The air flow can reach throughout the room.
- The connecting pipe and drainpipe could be extracted out easily.
- There is no direct radiation from heaters.



CAUTION

Keep indoor unit, outdoor unit, power supply wiring and transmission wiring at least 1 meter away from televisions and radios. This is to prevent image interference and noise in those electrical appliances. (Noise may be generated depending on the conditions under which the electric wave is generated, even if 1 meter is kept.)

5.2 Install the main body

■ The existing ceiling (to be horizontal)

- 1 Please cut a quadrangular hole of 600×600mm in the ceiling according to the shape of the installation paper board.
(Refer to Fig.5-3, Fig.5-4)
 - The center of the hole should be at the same position of that of the air conditioner body.
 - Determine the lengths and outlets of the connecting pipe, drainpipe and cables.
 - To balance the ceiling and to avoid vibration, please enforce the ceiling when necessary.
- 2 Please select the position of installation hooks according to the hook holes on the installation board.
 - Drill four holes of $\varnothing 12\text{mm}$, 50~50mm deep at the selected positions on the ceiling. Then embed the expansible hooks (fittings).
 - Face the concave side of the installation hooks toward the expansible hooks. Determine the length of the installation hooks from the height of ceiling, then cut off the unnecessary part.
 - If the ceiling is extremely high, please determine the length of the installation hook according to facts.
 - Cut the installation hook open in the middle position, then use appropriate length of reinforcing rod ($\varnothing 12$) to weld together.

The length could be calculated from Refer to Fig.5-5:
 $\text{Length} = 210 + L$ (in general, L is half of the whole length of the installation hook)

- 3 Please adjust the hexangular nuts on the four installation hooks evenly, to ensure the balance of the body.
 - If the drainpipe is awry, leakage will be caused by the malfunction of the water-level switch.
 - Adjust the position to ensure the gaps between the body and the four sides of ceiling are even. The body's lower part should sink into the ceiling for 10~12 mm (Refer to Fig.5-5).
 - Use the transparent hose filled with water to check the lever of the main body from the four sides or diagonal line direction, the lever indicator also can check the lever from four sides of the main body. (Refer to Fig.5-6)
 - Locate the air conditioner firmly by wrenching the nuts after having adjusted the body's position well.

■ New built houses and ceilings

- 1 In the case of new built house, the hook can be embedded in advance (refer to the A.b mentioned above). But it should be strong enough to bear the indoor unit and will not become loose because of concrete shrinking.
- 2 After installing the body, please fasten the installation paper board onto the air conditioner with bolts (M6X16) to determine in advance the sizes and positions of the hole opening on ceiling. (Refer to Fig.5-8)
 - Please first guarantee the flatness and horizontal of ceiling when installing it.
 - Refer to the A.a mentioned above for others.
- 3 Refer to the A.c mentioned above for installation.
- 4 Remove the installation paper board.



CAUTION

After installing the body, the four bolts (M6x12) must be fastened to the air conditioner onto ensure the body is grounded well.

Necessary room

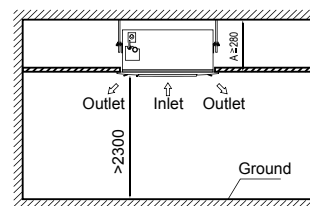

Fig.5-1

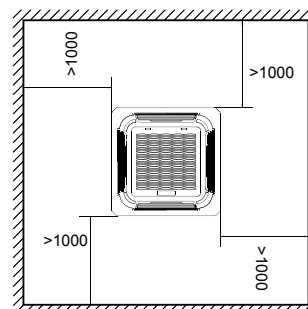

Fig.5-2

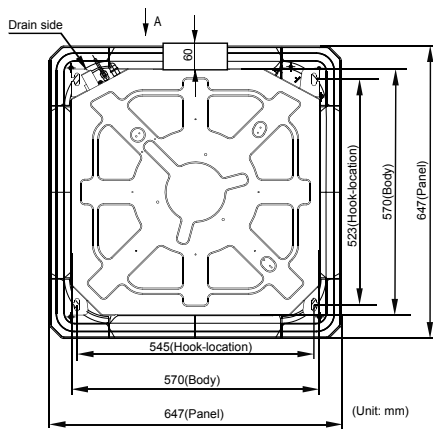

Fig. 5-3

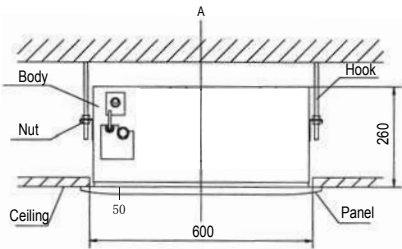

Fig. 5-4

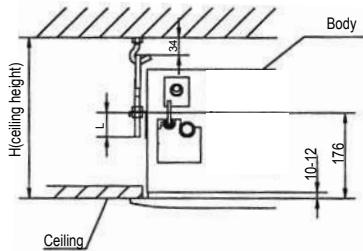

Fig. 5-5

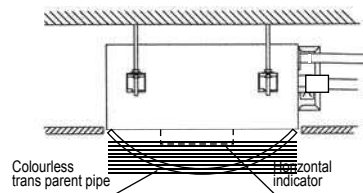

Fig. 5-6

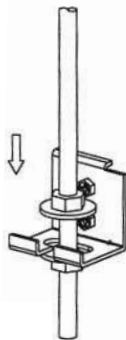

Fig. 5-7

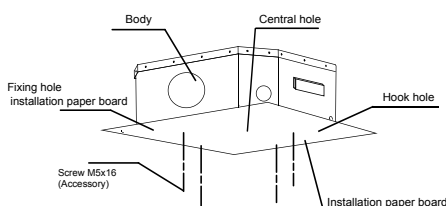

Fig. 5-8



NOTE

All the pictures in this manual are for explanation purpose only. They may be slightly different from the air conditioner you purchased (depend on model). The actual shape shall prevail.

5.3 Install The Panel



CAUTION

Never put the panel face down on floor or against the wall, or on bulgy objects.

Never crash or strike it.

1 Remove the air-in grill.

- Slide two grill switches toward the middle at the same time, and then pull them up. (Refer to Fig. 5-9)
- Draw the grill up to an angle of about 45°, and remove it. (Refer to Fig. 5-10)

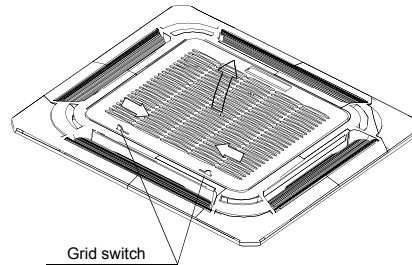

Fig. 5-9

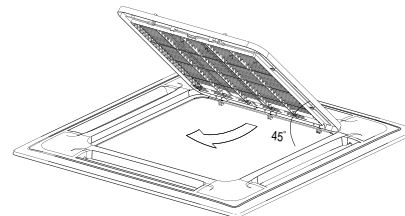

Fig. 5-10

2 Install the panel

- Align the swing motor on the panel to the tubing joints of the body properly. (Refer to Fig. 5-11)
- Hang the four fixed rope of the main body to the installation cover and the other three covers of the swing motor: (Refer to Fig. 5-11 ① and ②)



CAUTION

The installation cover of the swing motor must sink into the corresponding water receiver.

- Install the panel on the main body with bolt (M5×16) and washer. (Refer to Fig. 5-11④)
 - Adjust the four panel hook screws to keep the panel horizontal, and screw them up to the ceiling evenly.
 - Regulate the panel in the direction of the arrow in Fig. 5-11.③ slightly to fit the panel's center to the center of the ceiling's opening. Guarantee that hooks of four corners are fixed well.
 - Keep fastening the screws under the panel hooks, until the thickness of the sponge between the body and the panel's outlet has been reduced to about 4~6mm. The edge of the panel should contact with the ceiling well. (Refer to Fig. 5-12)
 - Malfunction described in Fig. 5-13 can be caused by inappropriate tightness the screw.
 - If the gap between the panel and ceiling still exists after fastening the screws, the height of the indoor unit should be modified again. (Refer to Fig. 5-14-left)
 - You can modify the height of the indoor unit through the openings on the panel's four corners, if the lift of the indoor unit and the drainpipe is not influenced (Refer to Fig. 5-14-right).
- 3 Hang the air-in grill to the panel, then connect the lead terminator of the swing motor and that of the control box with corresponding terminators on the body respectively.**
- 4 Relocate the air-in grid in the procedure of reversed order, install the air-in grid.**

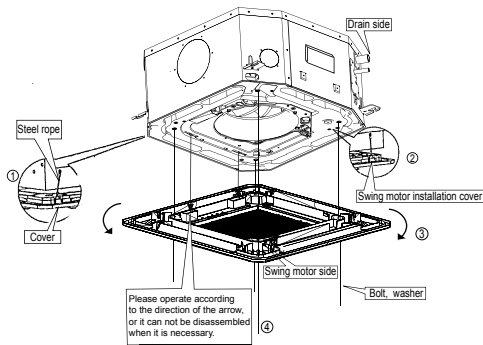

Fig. 5-11

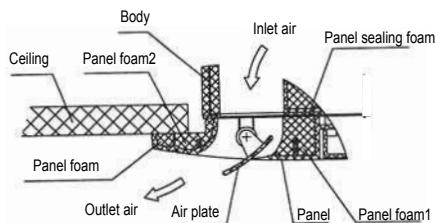

Fig. 5-12

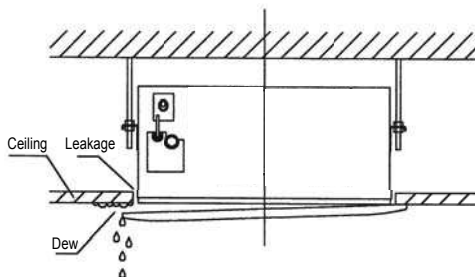

Fig. 5-13

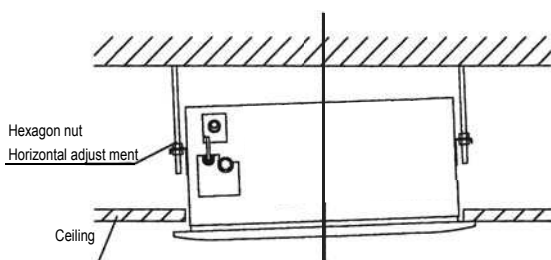

Fig. 5-14

6. INSTALL THE CONNECTING PIPE

- Check whether the height drop between the indoor unit and outdoor unit, the length of refrigerant pipe, and the number of the bends meet the following requirements:
 - The max height drop and The length of refrigerant pipe depending on the outdoor unit. (If the height drop is more than 10m, you had better put the outdoor unit over above the indoor unit.)
 - The number bends fewer than 15
 - Do not let air, dust, or other impurities fall in the pipe system during the time of installation.
 - The connecting pipe should not be installed until the indoor and outdoor units have been fixed already.
 - Keep the connecting pipe dry, and do not let moisture in during installation.
- The Procedure of Connecting Pipes

Measure the necessary length of the connecting pipe, and make it by the following way.

 - Connect the indoor unit at first, then the outdoor unit.
 - ① Bend the tubing in proper way. Dont harm them.
 - ② Daub the surfaces of the flare pipe and the joint nuts with frozen oil, and wrench it for 3~4rounds with hands before fasten the flare nuts. (Refer to Fig. 6-1)
 - ③ Be sure to use two wrenches simultaneously when you connect or disconnect the pipes.
 - The stop valve of the outdoor unit should be closed absolutely (as original state). Every time you connect it, first loosen the nuts at the part of stop valve, then connect the flare pipe immediately (in 5 minutes). If the nuts have been loosened for a long time, dusts and other impurities may enter the pipe system and may cause malfunction later. So please expel the air out of the pipe with refrigerant before connection.
 - Expel the air (refer to the "Expel The Air") after connecting the refrigerant pipe with the indoor unit and the outdoor unit. Then fasten the nuts at the repair-points.
- Notices For Benable pipe.
 - The bending angle should not exceed 90°C
 - Bending position is preferably in the bendable pipe. The larger the better it is .
 - Do not bend the pipe more than three times.
- Bend the connecting pipe of small wall thickness.
 - Cut out a desired concave at the bending part of the insulating pipe.
 - Then expose the pipe(cover it with tapes after bending).
 - To prevent collapsing of deforming, please bend the pipe at its biggest radius.
 - Use bender to get a small radius pipes.
- Use the market brass pipe.

Be sure to use the same insulating materials when you buy the brass pipe. (More than 9mm thick).

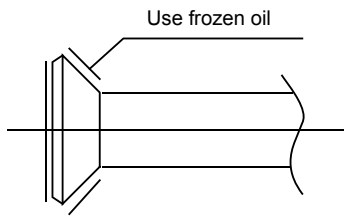

Fig.6-1

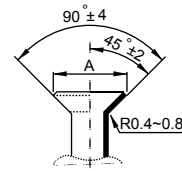
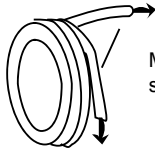

Fig.7-2

Bend the pipe with thumb



Fig.6-2



Make the ends straight

Fig.6-3

Table.7-1

Outside diameter	A(mm)	
	Max	Min
Φ6.4mm	8.7	8.3
Φ9.5mm	12.4	12.0
Φ12.7mm	15.8	15.4
Φ15.9mm	19.0	18.6
Φ19.1mm	23.3	22.9

■ Locate The Pipe

- Drill a hole in the wall (suitable just for the size of the wall conduit, 90mm in general), then set on the fittings such as the wall conduit and its cover.
- Bind the connecting pipe and the cables together tightly with binding tapes. Do not let air in, which will cause water leakage by condensation.
- Pass the bound connecting pipe through the wall conduit from outside. Be careful of the pipe all ocation to do no damage to the tubing.

■ Connect the pipes.

- Then, open the stem of stop valves of the outdoor unit to make the refrigerant pipe connecting the indoor unit with the outdoor unit fluently flow.

- Be sure of no leakage by checking it with leak detector or soap water.

- Cover the joint of the connecting pipe to the indoor unit with the sound proof/insulating sheath (fittings), and bind it well with the tapes to prevent leakage.

■ Fasten the nut

- Put the connecting tubing at the proper position, wrench the nuts with hands then fasten it with a wrench. (Refer to Fig.7-3)
- Too large torque will harm the bellmouthing and too small will cause leakage. Please determine the torque according to Table.7-2.

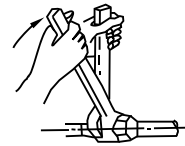

Fig.7-3

Table.7-2

Tubing size	Torque
Φ6.4mm	14.2~17.2N.m
Φ9.5mm	32.7~39.9N.m
Φ12.7mm	49.5~60.3N.m
Φ15.9mm	61.8~75.4N.m
Φ19.1mm	97.2~118.6N.m

7. REFRIGERANT PIPE CONNECTION

7.1 Expel The Air

■ Flaring

- Cut a pipe with a pipe cutter.
- Insert a flare nut into a pipe and flare the pipe.

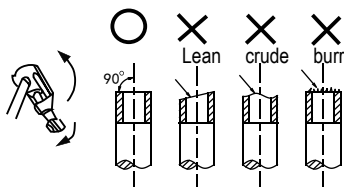

Fig.7-1

- The necessary filling amount of refrigerant
 - Refrigerant volume to be added is calculated according to outdoor unit installation manual .Be sure to add refrigerant measuring by a scale. L: The length of the pipe
 - Please record the quantity added and store it carefully for future maintenance.
- Expel the air with a vacuum pump (Refer to Fig.7-4) (Please refer to its manual for the way of using manifold valve)
 - Loosen and remove the maintenance nuts of stop valves A and B, and connect the charge hose of the manifold valve with the maintenance terminator of stop valve A. (Be sure that stop valves A and B are both closed)
 - Connect the joint of the charge hose with the vacuum pump.
 - Open the Lo-lever of the manifold valve completely.
 - Turn on the vacuum pump. At the beginning of pumping, loosen the maintenance terminator nut of stop valve B a little to check whether the air comes in (the sound of the pump changes, and the indicator of compound meter turns below zero). Then fasten the nut.
 - When the pumping has finished, close the Lo-lever of the manifold valve completely and turn off the vacuum pump.
 - When you have pumped for over 15 minutes, please confirm that the indicator of multimeter is on $-1.0 \times 10^5 \text{Pa}$ (-76cmHg)
 - Loosen and remove the quadrangle cover of stop valves A and B to open stop valve A and B completely, then fasten them.
 - Disassemble the charge hose from the repair-mouth of stop valve A, and fasten the nut.

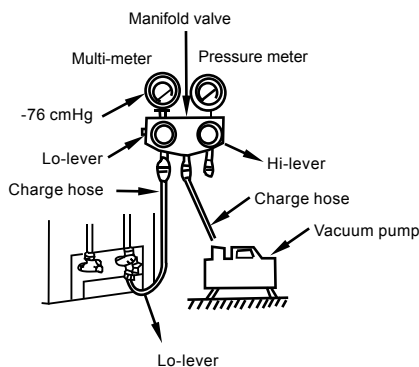

Fig.7-4

- All the stop valves should be opened before test operation. Each air conditioner has two stop valves of different sizes on the side of the outdoor unit which operate as Lo-stop value, respectively. (Refer to Fig.7-5)

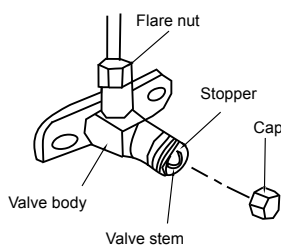
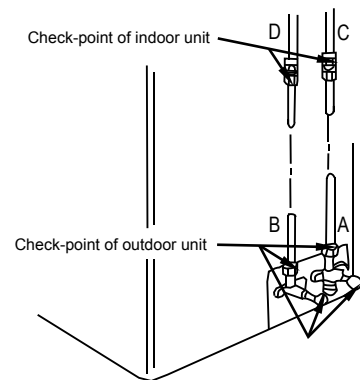

Fig.7-5

7.2 Check The Leakage

- Check all the joints with the leak detector or soap water. (See Fig.7-6 as a reference illustration)



A.....Lo-stop valve B.....Hi-stop valve
C,D...Joints of the connecting pipe to the indoor unit.

Fig.7-6

7.3 Insulation

- Be sure to with insulating materials cover all the exposed parts of the flare pipe joints and refrigerant pipe on the liquid-side and the gas-side. Ensure that there is no gap between them.
- Incomplete insulation may cause water condensation.

8. CONNECT THE DRAIN PIPE

8.1 Install The Drainpipe Of The Indoor Unit

- 1) The drainpipe can use PVC pipe (external diameter about 37~39mm, inner diameter is 32mm).
- 2) Joint drainpipe connector to the end side of water pumping pipe, and fix drainpipe together with water outflow pipe and thermal insulation tube by clasp of water outflow pipe (attached).



CAUTION

Don't use forcing strength to crack the water-pumping pipe.

- 3) Water-pumping pipe and drainpipe from main body must be wrapped by insulation tube evenly, and bound by tighten band for obstructing air getting in and coagulation.
- 4) Prevent from water backflow into unit inside during shutdown, the drain pipe shall place down side and drain water to outdoor (drain side), the gradient of the drain pipe should be higher than (1/100), without salient and water remain. (Refer to Fig.8-1 a)

5) When connecting drainpipe, don't drag the pipe that would pull the main unit. For this, please arrange bearing points every 0.8 to 1.0 meter to avoid pipe be bended (See Fig.8-1 b).

6) When connect a lengthen drainpipe, apply protective tube to wrap its indoor parts for ensuring the lengthen part connected tightly.

7) In case the drainpipe outlet is higher than pumping connective pipe of the main body, the drainpipe must be arranged upwards vertically by using connective assembly of the water outlet for vertical bending, and the height of the drainpipe shall set to the defrosting pan surface no more than 600mm, otherwise, too much backflow while shutdown would leads to overflow (Refer to Fig.8-2).

8) Base on the actual requirement to bend piping, and use connective assembly of water outlet in terminal box for pipe layout.

 **CAUTION**

The joints in drain system must be sealed to avoid water leakage.

9) The height from floor to the end of drainpipe or the bottom of drain slot must more than 50 mm. Don't immerse the end of drainpipe or the bottom of drain slot into water. When drain condensate liquid to raceway, please bend the drainpipe to a U-shaped hydroseal for avoiding stench transmitted by drainpipe to indoor.

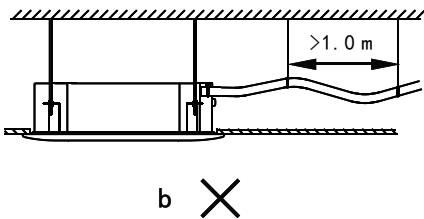
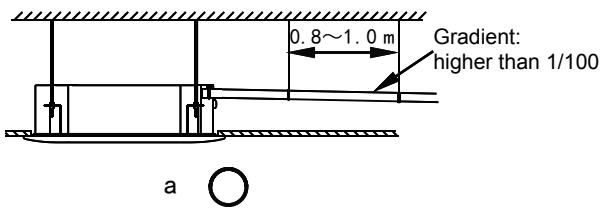

Fig. 8-1

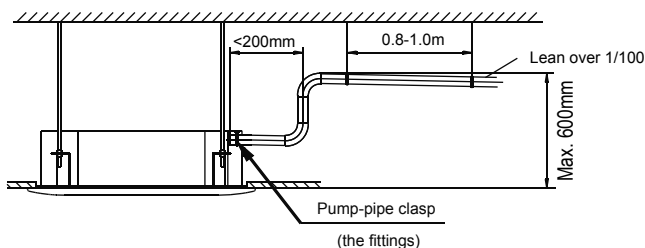

Fig. 8-2

8.2 Drainage Test

- Check whether the drainpipe is unhindered
- New built house should have this test done before paving the ceiling.

1. Remove the test cover, and stow water of about 2000ml to the water receiver through the stow tube.

2. Turn on the power, and operate the air conditioner under the "COOLING" mode. Listen to the sound of the drain pump. Check whether the water is discharged well (a lag of 1min is allowed before discharging, according to the length of the drain pipe), and check whether water leaks from the joints.

CAUTIONS: If there is any malfunction, please resolve it immediately.

3. Stop the air conditioner for three minutes, check if everything is ok. If the drain hose is located unreasonable, water overflow will cause the Alarm indicator lamp flashing (For both cooling and heating type or cooling only type), even the water leak out from the water receiver.

4. Check the drain pump whether drain water immediately when alarm sound for the high water lever. If the water lever can't come down below to the limited water lever, the air conditioner will stop. Restart it until turn off the power and drain off all the water.

5. Turn off the power, drain the water away.

- The drain plug is used to empty the water-receiver for maintenance of the air conditioner. Please stuff it imposition at all times during operation to avoid leakage.

9. WIRING

- Caution
- The air conditioner should use separate power supply with rated voltage, the voltage of power supply must be within 90%~110% of rated value.
- The external power supply to the air conditioner should have ground wiring, which is linked to the ground wiring of the indoor and outdoor unit.
- The wiring work should be done by qualified persons according to circuit drawing.
- A disconnection device having an air gap contact separation in all active conductors should be incorporated in the fixed wiring according to the National wiring regulation.
- Be sure to locate the power wiring and the signal wiring well to avoid cross-disturbance and their contact with connecting pipe or stop valve body.
- The wiring attached to this air conditioner is 6m long. Be sure to prolong it with wiring of the same type and proper length if necessary. Generally, do not twist two wiring together unless the joint is soldered well and covered with insulator tape.
- Do not turn on the power until you have checked carefully after wiring.
- The yellow and green wire can only be used to link to the ground wiring.
- The Specification of Power

Table.9-1

Model(W)		1500~5600
Power	Phase	1-Phase
	Frequency and volt	220-240~50Hz 208-230~60Hz
Circuit breaker/fuse (A)		15/15
Indoor unit power wiring (mm ²)		3×2.0
Indoor/outdoor connecting wiring(mm ²) (weak electric signal)		3-core shielded wire 3×0.5



CAUTION

- A disconnection device having an air gap contact separation in all active conductors should be incorporated in the fixed wiring according to the National Wiring Regulation.
- Ground the air conditioner properly to obtain a good anti-interference effect .

■ **Wiring chart**

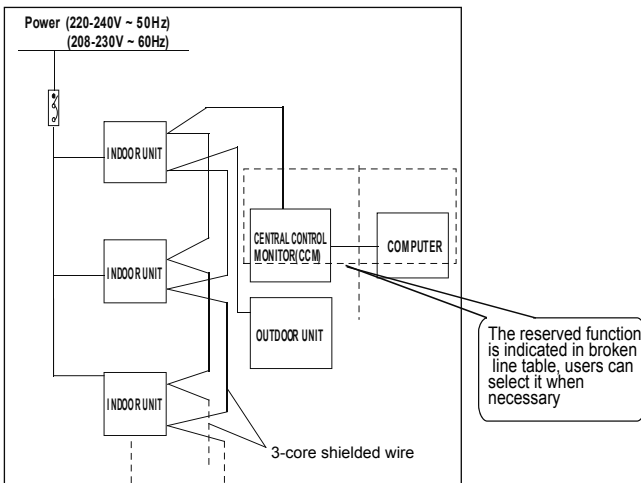
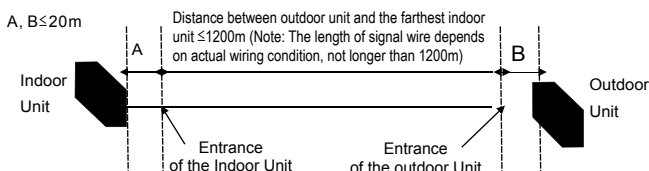

Fig.9-1



NOTE

- Please remember the surroundings (environmental temperature, direct sunlight, rain etc.)
- We consider the minimal size of the metal core as the wire size. So it is recommended you adopt a thicker one as the power conducting wire so as to avoid power decrease;
- Connect the grounded wire to both indoor and outdoor units;
- This chart is just an on-site wire-connecting example. For details, please refer to relative National criteria.



- Terminal board diagram
Please refer to the indoor unit wiring diagram for the wiring.



NOTE

The air-conditioners can connect with Central Control Monitor (CCM). Before operation, please wiring correctly and set system address and network address of indoor units.

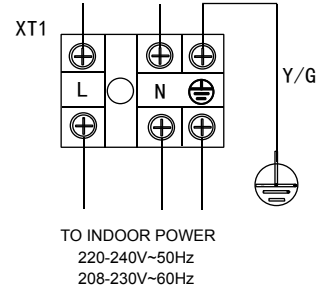

Fig.9-2

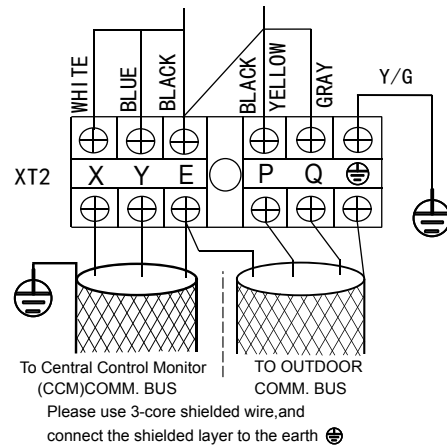

Fig.9-3

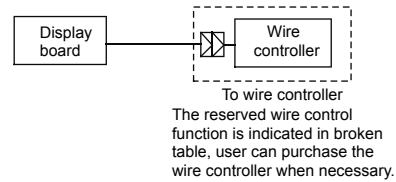
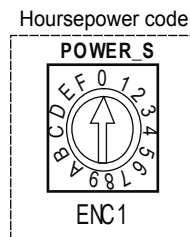

Fig.9-4

10. CONTROL

■ **Horsepower set**



Base on different purposes to setting the switch cords on PC panel of indoor electrical control box. Once finish the setting, please cut off the main power, and then input power again, otherwise, setting function could not work.

ENC1	Dial switch	Horsepower setting
Note: The horsepower has been set before leaving the factory, which can only be modified by professionals.	Code	Capacity(Horsepower)
	F	1500W(0.6HP)
	0	2200W(0.8HP)
	1	2800W(1.0HP)
	2	3600W(1.2HP)
	3	4500W(1.7HP)
	4	5600W(2.0HP)

■ Network address set

- Network address is set by communication of indoor and outdoor unit; the address is the same as indoor address, there is no need to set separately.
- The central control of indoor units can be done on outdoor unit, there is no need to control indoor unit separately, for details please refer to V4+ outdoor unit manual.
- For previous control of indoor units, the network can be set by connecting (X,Y,E) terminals, there is no need to set network address. The network can also be set by outer network module and main board (CN20).



CAUTION

The system together have 64units(0-63),everyone has only system addresscode,If two addresses are the same in one system, the abnormal operation will occur.

Please switch off the power before setting,otherwise the unexpected error will occur.

■ Main board Code designation

SW1 definition

<p>ON SW1 1 2 3 4</p>	<ul style="list-style-type: none"> ● 1 means factory test mode ● 0 means add. auto searching mode (default setting) 	<p>ON SW1 1 2 3 4</p>	<ul style="list-style-type: none"> ● 01 means DC fan static pressure is 1 (reserved)
<p>ON SW1 1 2 3 4</p>	<ul style="list-style-type: none"> ● 1 means DC fan is chosen ● 0 means AC fan is chosen 	<p>ON SW1 1 2 3 4</p>	<ul style="list-style-type: none"> ● 10 means DC fan static pressure is 2 (reserved)
<p>ON SW1 1 2 3 4</p>	<ul style="list-style-type: none"> ● 00 means DC fan static pressure is 0 (reserved) 	<p>ON SW1 1 2 3 4</p>	<ul style="list-style-type: none"> ● 11 means DC fan static pressure is 3 (reserved)

SW2 definition

<p>ON SW2 1 2 3 4</p>	<ul style="list-style-type: none"> ● 00 means the temperature is 15 degrees when shutting down the unit for cold wind proof. 	<p>ON SW2 1 2 3 4</p>	<ul style="list-style-type: none"> ● 00 means the time of stopping TERMAL fan is 4 minutes
<p>ON SW2 1 2 3 4</p>	<ul style="list-style-type: none"> ● 01 means the temperature is 20 degrees when shutting down the unit for cold wind proof. 	<p>ON SW2 1 2 3 4</p>	<ul style="list-style-type: none"> ● 01 means the time of stopping TERMAL fan is 8 minutes
<p>ON SW2 1 2 3 4</p>	<ul style="list-style-type: none"> ● 10 means the temperature is 24 degrees when shutting down the unit for cold wind proof. 	<p>ON SW2 1 2 3 4</p>	<ul style="list-style-type: none"> ● 10 means the time of stopping TERMAL fan is 12 minutes
<p>ON SW2 1 2 3 4</p>	<ul style="list-style-type: none"> ● 11 means the temperature is 26 degrees when shutting down the unit for cold wind proof. 	<p>ON SW2 1 2 3 4</p>	<ul style="list-style-type: none"> ● 11 means the time of stopping TERMAL fan is 16 minutes

SW5 definition

<p>ON SW5 1 2</p>	<ul style="list-style-type: none"> ● 00 means temperature compensation is 6 degrees under heating mode 	<p>ON SW5 1 2</p>	<ul style="list-style-type: none"> ● 10 means temperature compensation is 4 degrees under heating mode
<p>ON SW5 1 2</p>	<ul style="list-style-type: none"> ● 01 means temperature compensation is 2 degrees under heating mode 	<p>ON SW5 1 2</p>	<ul style="list-style-type: none"> ● 11 means temperature compensation is 8 degrees under heating mode

SW6 definition

	<ul style="list-style-type: none"> ● 1 means auto wind under auto mode ● 0 means auto wind under non auto mode
	reserved

J1, J2 definition

	J1 no Jumpers means power off memory function
	J1 Jumpers means no power off memory function
	reserved

11. TROUBLE SHOOTING

Table.12-1

NO.	Type	Contents	LED Lamp flash	Remarks
1	Malfunction	The evaporator sensor check point is abnormal or room temp. sensor is abnormal.	The run lamp flashes fast	After the malfunctions disappear, it restores automatically.
2	Malfunction	Indoor/outdoor unit communication is abnormal	The timer lamp flashes fast	After the malfunctions disappear, it restores automatically.
3	Malfunction	Outdoor unit is abnormal	The alarm lamp flashes slowly	After the malfunctions disappear, it restores automatically.
4	Malfunction	Water level switch is abnormal	The alarm lamp flashes fast	After the malfunctions disappear, it restores automatically.
5	Alarm	Mode conflict	The defrost lamp flashes fast	When the indoor unit turns to heating mode or is turned off, the alarm will disappear.
6	Alarm	M_Home mismatching	4 LED flash together	When the indoor unit is replaced with a correct one, the alarm will disappear
7	Malfunction	EEPROM error	Defrost LED flash slowly	After the malfunctions disappear, it restores automatically.
8	Alarm	No address when first time power on	Timer LED and run LED flash together	After the malfunctions disappear, it restores automatically.

12. TEST OPERATION

- The test operation must be carried out after the entire installation has been completed.
- Please confirm the following points before the test operation:
 - The indoor unit and outdoor unit are installed properly.
 - Tubing and wiring are correctly completed.
 - The refrigerant pipe system is leakage-checked.
 - The drainage is unimpeded.
 - The heating insulation works well.
 - The ground wiring is connected correctly.
 - The length of the tubing and the added stow capacity of the refrigerant have been recorded.
 - The power voltage fits the rated voltage of the air conditioner.
 - There is no obstacle at the outlet and inlet of the outdoor and indoor and indoor units.
 - The gas-side and liquid-side stop valves are both opened.
 - The air conditioner is pre-heated by turning on the power.
- Test operation

Set the air conditioner under the mode of "COOLING" with the remote controller, and check the following points per the "Owner's Manual" If there is any malfunction, please resolve it as per chapter "Troubles And Causes".

 - The indoor unit
 - Whether the switch on the remote controller works well.
 - Whether the buttons on the remote controller works well.
 - Whether the air flow louver moves normally.
 - Whether the room temperature is adjusted well.
 - Whether the indicator lights normally.
 - Whether the temporary buttons works well.
 - Whether the drainage is normal.
 - Whether there is vibration or abnormal noise during operation.
 - The outdoor unit
 - Whether the air conditioner heats well in the case of the HEATING/COOLING type.
 - Whether there is vibration or abnormal noise during operation.
 - Whether the generated wind, noise, or condensed of by the air conditioner have influenced your neighborhood.
 - Whether any of the refrigerant is leaked.



CAUTION

Protection function will delay the startup of compressor for 3 minutes in case the unit is turned on immediately after power on or restarted after shutdown.

MDV11I-025EW

202000171762