

### 3. Wired Remote Controller

#### Wired Remote Controller / K70D036Z

##### ■ How to Use the Wired Remote Controller





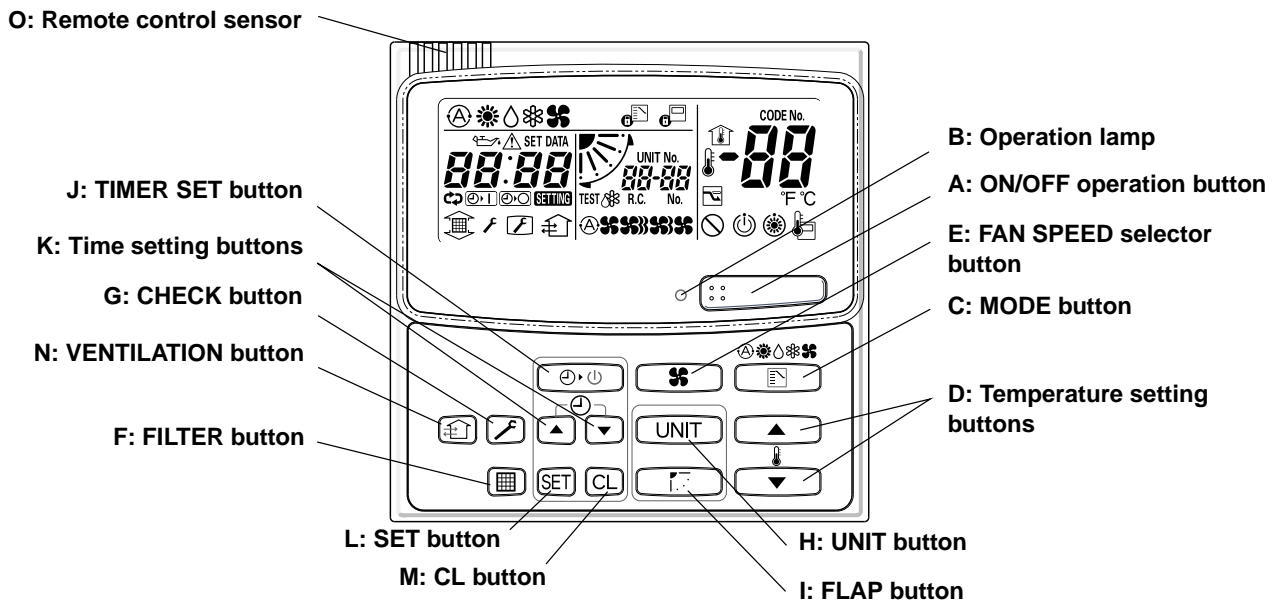



















- This remote control unit can be used to operate up to 8 indoor units. Once the operation settings are made, the units can be operated by simply pressing the ON/OFF operation button.
- In the SPW-AS, U, D, F and FM series, the flap position is not shown on the display.
- The SPW-DR764/964GXH56 does not have a dry function.

3



<b>A: ON/OFF operation button</b>	This button is for turning the air conditioner on and off.
<b>B: Operation lamp</b>	This lamp lights when the air conditioner is turned on. This lamp blinks when an error occurs or a protective device is activated.
<b>C: MODE button</b>	Use this button to select one of the following 5 operating modes. (AUTO) ☼ : Used to automatically set cooling or heating operation. Only for single heat pump type. (HEAT) ☀ : Used for normal heating operation. Only for heat pump type. (DRY) ☹ : Used for dehumidifying without changing the room temperature. (COOL) ☼ : Used for normal cooling operation. (FAN) ☼ : Used to run the fan only, without heating or cooling operation. (Temperature range: 17 to 27°C) (Temperature range: 16 to 30°C) (Temperature range: 18 to 30°C) (Temperature range: 18 to 30°C)
<b>D: Temperature setting buttons</b>	☺ : Press this button to increase the temperature setting. ☻ : Press this button to decrease the temperature setting.
<b>E: FAN SPEED selector button</b>	☼☼ : The air conditioner automatically decides the fan speeds. ☼☼☼ : High fan speed ☼☼ : Medium fan speed ☼☼ : Low fan speed







### 3. Wired Remote Controller

<p><b>F: FILTER button</b></p>	<p>This button is used to turn off the filter sign (  ). When the filter sign appears on the display, clean the filter, and then press this button to turn off the sign.</p>																
<p><b>G: CHECK button</b></p> <div style="text-align: center;">  <span style="border: 1px solid black; padding: 2px;"><b>CAUTION</b></span> </div>	<p>This button is used only when servicing the air conditioner.</p> <p><b>Do not use the CHECK button for normal operation.</b></p>																
<p><b>H: UNIT button</b></p>	<p>When more than one indoor unit is connected, this button is used to select a unit when adjusting the airflow direction.</p> <p>If no unit is selected, the airflow direction of all units can be adjusted concurrently using the FLAP button.</p>																
<p><b>I: FLAP button</b></p> <div style="text-align: center;">  <span style="border: 1px solid black; padding: 2px;"><b>CAUTION</b></span> </div> <div style="text-align: center; margin-top: 20px;"> <span style="border: 1px solid black; padding: 2px;"><b>NOTE</b></span>  <b>(SWEEP)</b> </div> <div style="text-align: center; margin-top: 20px;"> <span style="border: 1px solid black; padding: 2px;"><b>NOTE</b></span> </div>	<p>1. Use this button to set the airflow direction to a specific angle. The airflow direction is displayed on the remote control unit.</p> <table border="1" style="width: 100%; border-collapse: collapse;"> <thead> <tr> <th style="text-align: left;">Operation mode</th> <th style="text-align: left;">Number of airflow direction settings</th> </tr> </thead> <tbody> <tr> <td> (COOL) or  (DRY)</td> <td>3</td> </tr> <tr> <td> (HEAT) or  (FAN)</td> <td>5</td> </tr> <tr> <td> (AUTO)</td> <td></td> </tr> <tr> <td style="padding-left: 20px;">Cooling mode:</td> <td>3</td> </tr> <tr> <td style="padding-left: 20px;">Heating mode:</td> <td>5</td> </tr> </tbody> </table> <ul style="list-style-type: none"> <li>• In the Cool mode and Dry mode, if the flaps are set in a downward position, condensation may form and drip around the vent.</li> <li>• Do not move the flap with your hands.</li> </ul> <p><b>NOTE</b> This function is available only for models X, LD, S, T and K.</p> <p>2. Use this button to make the airflow direction sweep up and down automatically. Press this button several times until the  symbol appears on the display.</p> <p><b>To stop the swing operation</b> Press the FLAP button again during the flap swing operation to stop the flap at the desired position. Then, the airflow can be set from the top position by pressing the FLAP button again.</p> <p><b>Indicator when swing operation is stopped</b></p> <table border="1" style="width: 100%; border-collapse: collapse;"> <thead> <tr> <th style="text-align: center;">Fan and heating</th> <th style="text-align: center;">Cooling and drying</th> </tr> </thead> <tbody> <tr> <td style="text-align: center;"></td> <td style="text-align: center;"></td> </tr> </tbody> </table> <p>During cooling and drying, the flap does not stop at the downward position. Even if the flap is stopped at the downward position during the swing operation, it does not stop until it moves to the third position from the top.</p> <p><b>NOTE</b> This function is available only for models AWS,ASS,FC,ACS</p>	Operation mode	Number of airflow direction settings	 (COOL) or  (DRY)	3	 (HEAT) or  (FAN)	5	 (AUTO)		Cooling mode:	3	Heating mode:	5	Fan and heating	Cooling and drying		
Operation mode	Number of airflow direction settings																
 (COOL) or  (DRY)	3																
 (HEAT) or  (FAN)	5																
 (AUTO)																	
Cooling mode:	3																
Heating mode:	5																
Fan and heating	Cooling and drying																
																	



### 3. Wired Remote Controller

3

<b>J: TIMER SET button</b> (OFF Timer) (OFF Cycle Timer) (ON Timer)	Use this button while the unit is operating to switch between timer settings.  : The air conditioner stops after a preset time elapses.  : The air conditioner always stops after a preset time elapses.  : The air conditioner starts after a preset time elapses.
<b>K: Time setting buttons</b>	 : Press this button to increase the time.  : Press this button to decrease the time.
<b>L: SET button</b>	Use this button to set the timer.
<b>M: CL button</b>	Use this button to clear the timer setting.
<b>N: VENTILATION button</b>	This is used when a ventilation fan (available commercially) is connected. Pressing the VENTILATION button turns the fan on and off. The ventilation fan also turns on and off when the air conditioner unit is turned on and off. (The display of the remote control unit shows “  ” while the ventilation fan is running.) * If “  ” is shown on the display of the remote control unit when the VENTILATION button is pressed, this indicates that the ventilation fan is not connected.
<b>O: Remote control sensor</b>	Normally, the temperature sensor of the indoor unit is used to detect the temperature. However, it is also possible to detect the temperature around the remote control unit. For details, contact the dealer where you made the purchase. (Do not set when using group control.)

- NOTE**
- 1) When 2 remote control units are being used in one group control\* system,
    - a) the most recent button that is pressed on any remote control unit is effective.
    - b) either a main-remote control unit or a sub-remote control can set the timer.
      - \* Group control means that maximum up to 8 indoor units can be concurrently controlled with a remote control unit.
  - 2) If a power failure occurs in timer mode, the time counted up to that point will be stored in memory.  
 After power is restored, the timer starts again counting up to the set time.

### 3. Wired Remote Controller

#### ■ Display

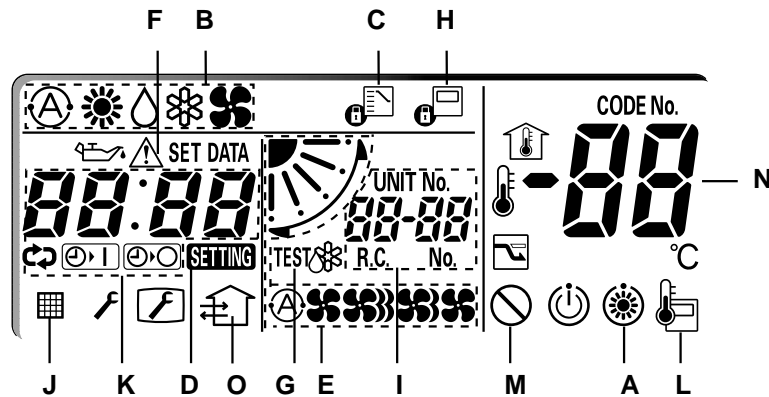

#### Description

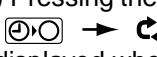
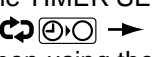
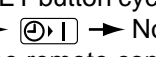
- A:** When the unit is in heating standby status, the ☀ indicator appears. While this indicator is displayed, the indoor fan turns off or on at low fan speed.
- B:** The currently selected operation mode is displayed.  
\* The SPW-DR764/964GXH56 shows the dry indicator, but it does not have a dry function.
- C:** This is displayed if a different operation mode was selected already by another remote control unit and indicates that the mode cannot be changed.
- D:** After turning on the mains power switch for the first time, **SETTING** indicator blinks on the display of the remote control unit. While this is displayed, the system is automatically checking units, and so wait until the **SETTING** indicator turns off to operate the remote control unit. When the **TIMER SET** button is pressed to set the timer, the **SETTING** indicator flashes.
- E:** The currently selected FAN SPEED, fan angle and SWEEP status are displayed.
- F:** This is displayed only if an abnormality occurs within a unit.
- G:** When the **CHECK** button is pressed for more than 4 seconds, the **TEST** indicator appears. Then, press the **ON/OFF** operation button to start test run.
- H:** This is displayed to indicate that the system controller is being used for control. When  is flashing on the display, the operation is not accepted by the system controller.
- I:** This displays the unit number of the indoor unit selected with the unit selection button or the indoor/outdoor unit where an error is indicated.  
 Unit No.  
 1 - 2  
 |  
 |—— Indoor unit No.  
 |—— Refrigerant circuit No.
- J:** This is displayed if it is time to clean the filter.
- K:** When setting the timer, the selected timer mode is displayed. This displays the time of the timer. (An alarm message is displayed when an error occurs.) Pressing the **TIMER SET** button cycles through the options in this order:  →  →  → No Display
- L:** This is displayed when using the remote control unit sensor.
- M:** This is displayed if a function is unavailable when a button is pressed.
- N:** This displays the temperature setting.
- O:** This is displayed when a connected ventilation fan (available commercially) is operating.

### 3. Wired Remote Controller

#### ■ Setting the Timer

**Using the timer** Set the timer during air conditioner operation.

Recommended usage		Display
To stop the air conditioner after a preset time elapses	OFF timer	
To always stop the air conditioner after a preset time elapses	OFF cycle timer	
To start the air conditioner after a preset time elapses	ON timer	

**Time indicator of timer** Each time is pressed, the time setting increases at 0.5-hour (30 minute) intervals. The upper limit is 72.0 hours.  
Each time is pressed, the time setting decreases at 0.5-hour (30 minute) intervals. The lower limit is 0.5 hours.

**Timer indicator** The timer cycles through the following options each time (TIMER SET button) is pressed.



#### OFF timer

Use this mode to turn off the unit automatically after a preset time elapses.

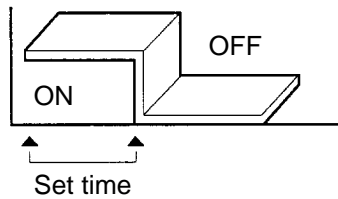

#### OFF cycle timer

Use this mode to always turn off the unit automatically after a preset time elapses.

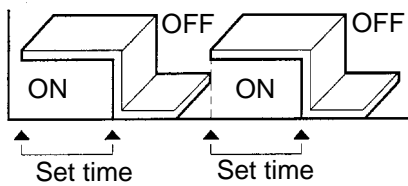

#### ON timer

Use this mode to start the unit automatically after a preset time elapses.

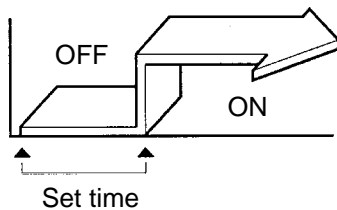

**NOTE**

When 2 remote control units are being used, either a main remote control unit or a sub remote control unit can be used for timer operations.

### 3. Wired Remote Controller

#### How to set the OFF timer (⏸)

Example: Stopping the air conditioner after 3.5 hours of operation

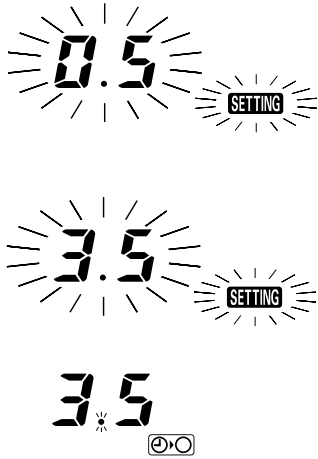

- | Operation  | Indication  |
|--|---|
| 1. Press the <b>ON/OFF</b> button once to start the air conditioner.                             |   |
| 2. Press the <b>TIMER SET</b> button to select the ⏸ mode.                                       | ➔ The <b>SETTING</b> and time indications (hour) flash. |
| 3. Press the ▲ button until 3.5 is displayed.<br>Press the ▼ button if the set time is exceeded. |   |
| 4. Press the <b>SET</b> button to set the OFF timer.   |   |

#### How to set the OFF cycle timer (⏸⏹)

Example: Always stopping the air conditioner after 3.5 hours of operation



- | Operation   |
|---|
| 1. Press the <b>ON/OFF</b> button to start the air conditioner.   |
| 2. Press the <b>TIMER SET</b> button twice to select the ⏸⏹ mode. |
| 3. Set the time using the ▲ or ▼ button.                          |
| 4. Press the <b>SET</b> button to set the OFF cycle timer (⏸⏹).   |

**NOTE** When the OFF cycle timer is set, the unit will always stop after 3.5 hours of operation.

#### How to set the ON timer (⏹)

Example: Starting the air conditioner 10.5 hours after the ON time setting



- | Operation   | Indication  |
|---|---|
| 1. Press the <b>ON/OFF</b> button to start the air conditioner.                                   |   |
| 2. Press the <b>TIMER SET</b> button to select ⏹ mode.  | ➔ The <b>SETTING</b> and time indications (hour) flash. |
| 3. Press the ▲ button until 10.5 is displayed.<br>Press the ▼ button if the set time is exceeded. |   |
| 4. Press the <b>SET</b> button to set the ON timer.   |   |

**NOTE** When the ON timer is set, the unit enters the paused state.

#### Canceling timer operation

Press the CL button to cancel operation. The time setting is canceled, and the timer indicator no longer appears on the display.

### 3. Wired Remote Controller

#### ■ How to Install the Remote Controller

Remote controller wiring can be extended to a maximum of 1,000 m.



- Do not twist the control wiring with the power wiring or run it in the same metal conduit, because this may cause malfunction.
- Install the remote controller away from sources of electrical noise.
- Install a noise filter or take other appropriate action if electrical noise affects the power supply circuit of the unit.

3

The mounting position for the remote controller should be located in an accessible place for control. Never cover the remote controller or recess it into the wall.

- (1) When you open the decorative cover, you will see 2 gaps under the remote controller. Insert a coin into these gaps and pry off the back case.

#### When Using a Wall Box for Flush Mounting

- If local codes allow, this remote controller can be mounted using a conventional wall box for flush mounting.
- (2) Attach the back case with the 2 small screws provided. Using a screwdriver, push open the cut-outs on the back case. These holes are for screws. Use the spacers and take care not to tighten the screws excessively. If the back case will not seat well, cut the spacers to a suitable thickness.
  - (3) Connect the remote controller wiring (3 wires) correctly to the corresponding terminals in the electrical component box of the indoor unit.



**When wiring, do not connect the remote controller wires to the adjacent terminal block for the power wiring. Otherwise, the unit will break down.**

- (4) To finish, fit the back tabs of the case into the remote controller and mount it.



**CAUTION**

**Do not supply power to the unit or try to operate it until the tubing and wiring to the outdoor unit is completed.**

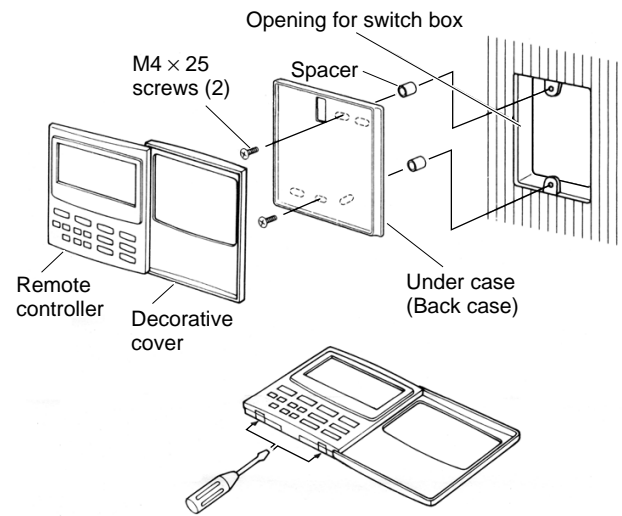

#### Accessories for remote controller switch

No.	Supplied parts	Q'ty	No.	Supplied parts	Q'ty
1	Remote controller switch (with 200 mm wire)	1	4	Spacers	2
2	Small screws M4 x 25	2	5	Wire joints	2
3	Wood screws	2			

#### Diagram of outer dimensions

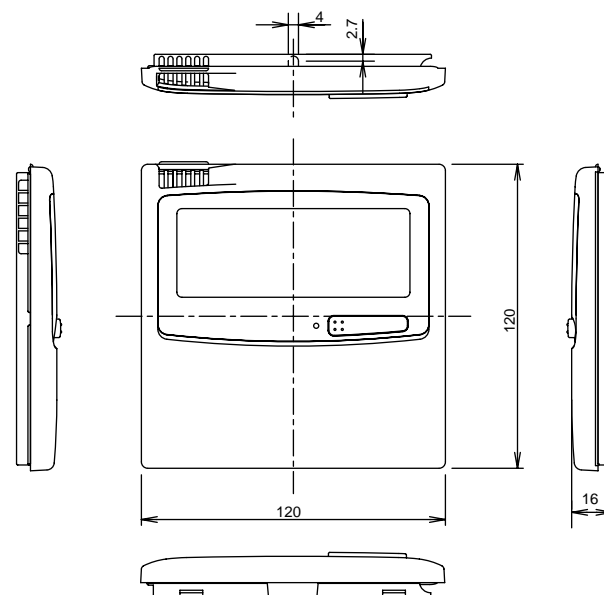

### 3. Wired Remote Controller

#### Basic Wiring Diagram



**CAUTION**

Install wiring correctly (incorrect wiring will damage the equipment).

- Use shielded wires for remote control wiring and ground the shield on both sides. Otherwise misoperation due to electrical noise may occur.

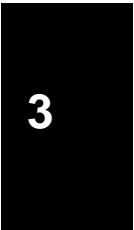
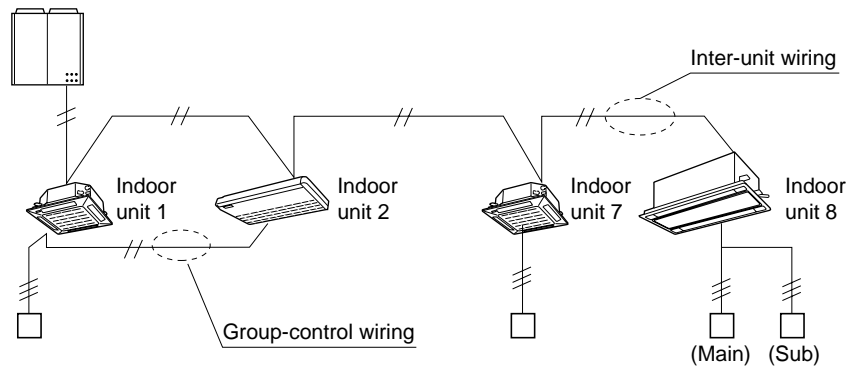
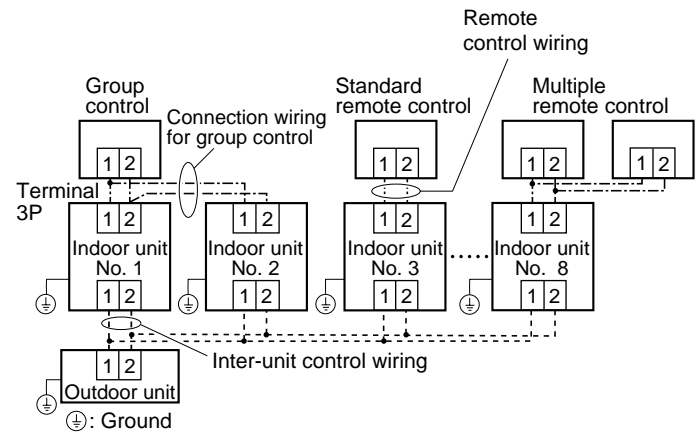
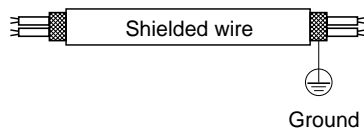

#### Wiring System Diagram for Group Control

This diagram shows when several units (maximum of 8) are controlled by a remote controller (main unit). In this case, a remote controller can be connected at any indoor unit.

#### Wiring procedure

Wire according to the diagram at right:

- Each successive unit will respond at 1-second intervals following the order of the group address when the remote controller is operated.

#### Group control using 2 remote controllers

It does not matter which of the 2 remote controllers you set as the main controller.

When using multiple remote controllers (up to 2 can be used), one serves as the main remote controller and the other as the sub-remote controller.

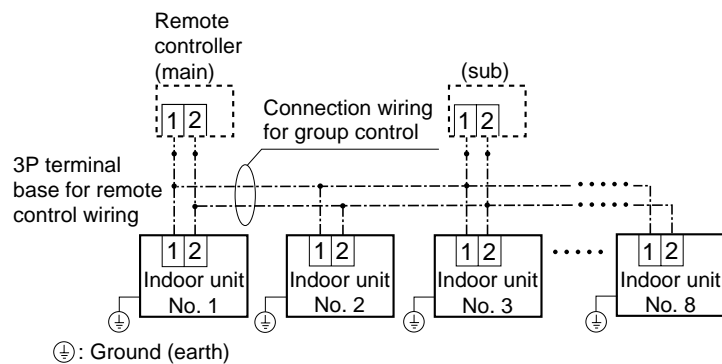
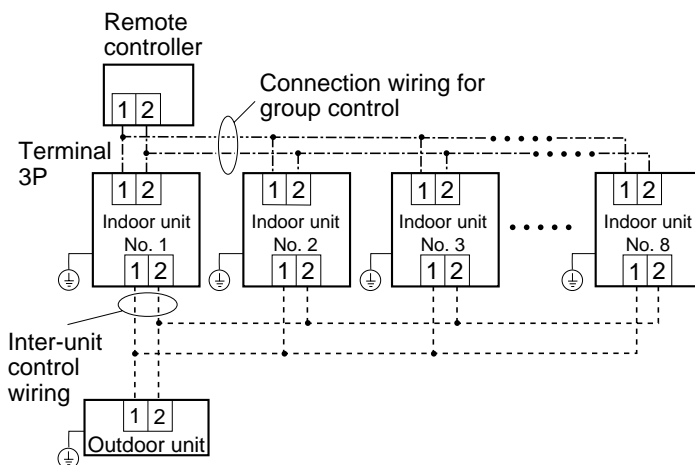

### 3. Wired Remote Controller

#### Setting the main and sub remote controllers

1. Set one of the 2 connected remote controllers as the main remote controller.
2. On the other remote controller (sub-remote controller), switch the remote controller address connector on the rear of the remote controller PCB from Main to Sub. When the connector has been switched, the remote controller will function as the sub-remote controller.  
The sub-remote controller will also operate when connected to the indoor unit (indoor unit 2 or 3).

3

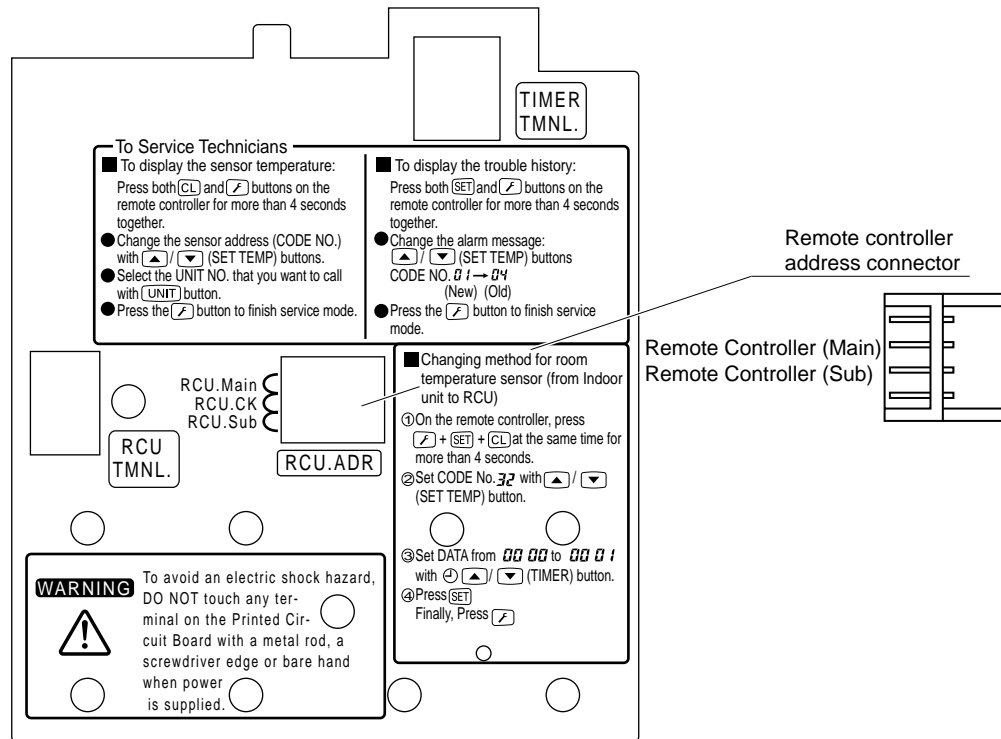

#### NOTE

##### Cautions on group control

- Group control within the same refrigerant tubing system is recommended.

[Tubing system which is NOT recommended]

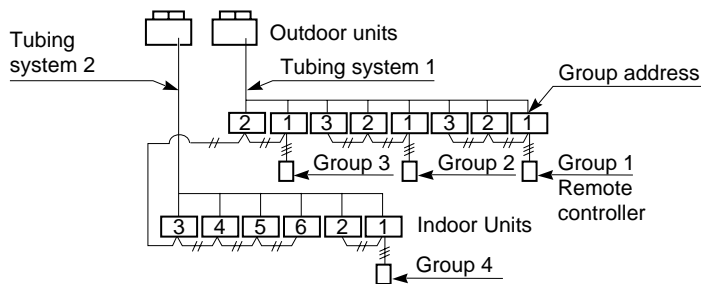

<Example 1> In the Mini ECO-i system, group control extending over tubing systems becomes impossible to set, which means the indoor units cannot operate.



While Group 4 is in heating operation, if later Group 3 begins cooling operation, indoor units 1, 2 of Group 3 can be operated, but the indoor units 3-6 of Group 4 cannot operate.

### 3. Wired Remote Controller

#### ■ Switching the Room Temperature Sensors

Room temperature sensors are contained in the indoor unit and in the remote controller.



One or the other of the temperature sensors is used for operation. Normally, the indoor unit sensor is set; however, the procedure below can be used to switch to the remote controller sensor.

(1) Press and hold the  +  +  buttons for 4 seconds or longer.

#### NOTE

- The unit No. that is initially displayed is the indoor unit address of the group control main unit.
- Do not press the  button.

(2) Use the temperature setting  /  buttons to select item code 32.

(3) Use the timer time  /  buttons to change the setting data from 0000 to 0001.

(4) Press the  button. (The change is completed when the display stops blinking.)

(5) Press the  button.



The unit returns to normal stop status. At this time, "Remote controller sensor" is displayed on the LCD.

#### NOTE

- If 2 remote controllers are used for control, this setting can be made from either the main or sub remote controller. However, the temperature sensor that is used is the sensor in the main remote controller.
- When group control is used, the remote controller sensor will not function unless the group address is set to the address of the main indoor unit.
- If both the remote sensor and remote controller are used, do not use the temperature sensor in the remote controller.

#### ■ Connecting to a Ventilation Fan



If a commercially available ventilation fan or similar device is run from the ventilation fan output terminal (FAN DRIVE: 2P (white), DC 12 V) (Note) on the indoor unit PCB, use the  button to enable fan operation and change the settings.

(1) Press and hold the  +  +  buttons for 4 seconds or longer.

#### NOTE

- The unit No. that is initially displayed is the indoor unit address of the group control main unit.
- Do not press the  button.

(2) Use the temperature setting  /  buttons to select item code 31.

(3) Use the timer time  /  buttons to change the setting data from 0000 to 0001.

(4) Press the  button. (The change is completed when the display stops blinking.)

(5) Press the  button.

The unit returns to normal stop status. Press the  button and check that "Fan" is displayed on the LCD display.

(Note) A special adapter (optional) is required to convert the signal for use at the no-voltage A contact.

### 3. Wired Remote Controller

#### ■ Wiring the Remote Controller

<Flush Mounting>

#### ● Connection diagram

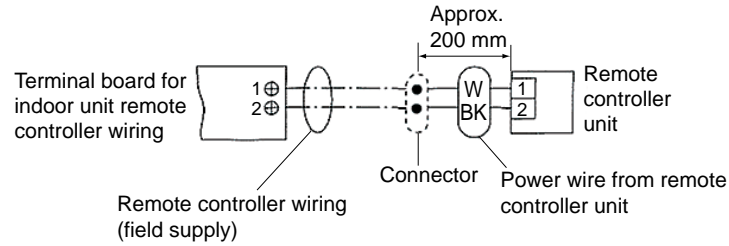

#### ● Use 0.5 mm<sup>2</sup> – 2 mm<sup>2</sup> wires.

- (1) Strip the insulation to approximately 14 mm from the ends of the wires that will be connected.
- (2) Twist together the 2 wires and create a crimp connection at the wire joint.
- (3) If a special crimping tool is not used, or if the connection is soldered, insulate the wires using insulation tape.

#### Provided wire joint (white)

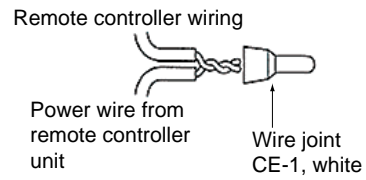

#### ● Use the remote controller cord (optional) for remote controller wiring.

- (1) Disconnect the lead wire that is wound around the lead wire anchor on the remote controller unit. Disconnect the connector and connect the remote controller cord (optional) to the connector on the remote controller unit. Insert the remote controller cord (optional) into the groove and bend it into the correct shape, then wind it around the lead wire anchor.
- (2) If the remote controller cord (optional) is used, refer to the installation manual that is provided with the cord.

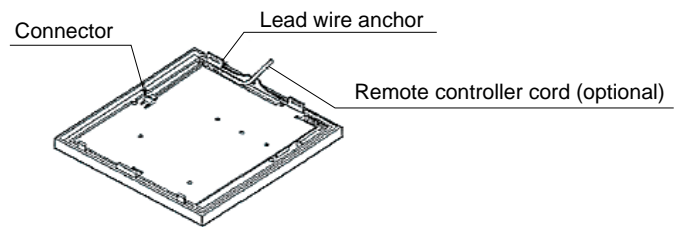

3

### 3. Wired Remote Controller

#### ■ Meaning of Alarm Messages

#### Table of Self-Diagnostics Functions and Description of Alarm Displays

Alarm messages are indicated by the blinking of LED 1 and 2 (D72, D75) on the outdoor unit PCB. They are also displayed on the wired remote controller.

#### ● LED 1 and 2 (D72 and D75) alarm displays

LED 1	LED 2	Alarm contents
☼	☼	Alarm display
Alternating		LED 1 blinks M times, then LED 2 blinks N times. The cycle then repeats. M = 2: P alarm 3: H alarm 4: E alarm 5: F alarm 6: L alarm N = Alarm No. Example: LED 1 blinks 2 times, then LED 2 blinks 17 times. The cycle then repeats. Alarm is "P17."

(☼: Blinking)

Possible cause of malfunction			Alarm message	
Serial communication errors Mis-setting	Remote controller is detecting error signal from indoor unit.	Error in receiving serial communication signal. (Signal from main indoor unit in case of group control) Ex: Auto address is not completed.	(See note) <E01>	
		Error in transmitting serial communication signal.	<E02>	
	Indoor unit is detecting error signal from remote controller (and system controller).		<<E03>>	
	Indoor unit is detecting error signal from outdoor unit.	Error in receiving serial communication signal. When turning on the power supply, the number of connected indoor units does not correspond to the number set. (Except R.C. address is "0.")	E04	
		Error of the outdoor unit in receiving serial communication signal from the indoor unit.	<E06>	
Improper setting of indoor unit or remote controller.		Indoor unit address setting is duplicated.	E08	
		Remote controller address connector (RCU. ADR) is duplicated. (Duplication of main remote controller)	<<E09>>	
		Error in driver communication signal for DC Inverter Fan.	E10	
During auto. address setting, number of connected units does not correspond to number set.		Starting auto. address setting is prohibited. This alarm message shows that the auto address connector CN100 is shorted while other RC line is executing auto address operation.	E12	
When turning on the power supply, number of connected units does not correspond to number set. (Except R.C. address is "0.")		Error in auto. address setting. (Number of connected indoor units is less than the number set)	E15	
		Error in auto. address setting. (Number of connected indoor units is more than the number set)	E16	
		No indoor unit is connected during auto. address setting.	E20	
		Error of outdoor unit address setting.	E25	
Indoor unit communication error of group control wiring.		Error of main indoor unit in receiving serial communication signal from sub indoor units.	E18	
Improper setting.		This alarm message shows when the indoor unit for multiple-use is not connected to the outdoor unit.	L02	
		Duplication of main indoor unit address setting in group control.	<L03>	
		Duplication of outdoor R.C. address setting.	L04	
		There are 2 or more indoor units controllers which have operation mode priority in 1 refrigerant circuit.	Priority set remote controller	L05
			Non-priority set remote controller	L06
		Group control wiring is connected to individual control indoor unit.	L07	
		Indoor unit address is not set.	L08	
		Capacity code of indoor unit is not set.	<<L09>>	
		Capacity code of outdoor unit is not set.	L10	
		Mis-match connection of outdoor units which have different kinds of refrigerant.	L17	
4-way valve operation failure	L18			

Continued

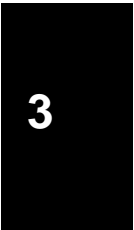

### 3. Wired Remote Controller



Possible cause of malfunction			Alarm message
Activation of protective device	Protective device in outdoor unit is activated.	Thermal protector in indoor unit fan motor is activated. Improper wiring connections of ceiling panel.	<<P01>> <<P09>>
		Float switch is activated.	<<P10>>
		Incorrect discharge temperature.	P03
		High pressure switch is activated.	P04
		Outdoor unit fan motor is unusual.	P22
		Compressor running failure resulting from missing phase in the compressor wiring, etc. (Start failure not caused by IPM or no gas.)	P16
		Overcurrent at time of compressor runs more than 80Hz (DCCT secondary current or ACCT primary current is detected at a time other than when IPM has tripped.)	P26
		IPM trip (IPM current or temperature)	H31
		Inverter for compressor is unusual. (DC compressor does not operate.)	P29
Thermistor fault	Indoor thermistor is either open or damaged.	Indoor coil temp. sensor (E1) (See Note)	<<F01>>
		Indoor coil temp. sensor (E2)	<<F02>>
		Indoor coil temp. sensor (E3)	<<F03>>
		Indoor suction air (room) temp. sensor (TA)	<<F10>>
		Indoor discharge air temp. sensor (BL)	<<F11>>
	Outdoor thermistor is either open or damaged.	Comp. No. 1 discharge gas temp. sensor (T,D)	F04
		Outdoor No. 1 coil gas temp. sensor (C1)	F06
		Outdoor air temp. sensor (T,O)	F08
		Compressor suction temperature sensor (T,S)	F12
		High pressure sensor	F16
EEPROM on indoor unit PCB failure			F29
Protective device for compressor is activated	Protective device for compressor is activated.	EEPROM on the outdoor unit PCB has failed.	F31
		Overload current is detected.	H01
		Lock current is detected.	H02
		Current is not detected when comp. is ON.	H03
		Discharge gas temperature of the comp. is not detected. Temp. sensor is not seated at the sensor holder.	H05
<b>Alarm messages displayed on system controller</b>			
Serial communication errors Mis-setting	Error in transmitting serial communication signal	Indoor or outdoor unit is not operating correctly. Mis-wiring of control wiring between indoor unit, outdoor unit and system controller.	C05
	Error in receiving serial communication signal	Indoor or outdoor unit is not operating correctly. Mis-wiring of control wiring between indoor unit, outdoor unit and system controller. CN1 is not connected properly.	C06
Activation of protective device	Protective device of sub indoor unit in group control is activated.	When using wireless remote controller or system controller, in order to check the alarm message in detail, connect wired remote controller to indoor unit temporarily.	P30

**NOTE**

1. Alarm messages in << >> do not affect other indoor unit operations.
2. Alarm messages in < > sometimes affect other indoor unit operations depending on the fault.