



**OPERATING INSTRUCTIONS • INSTRUCCIONES DE USO
NOTICE D'UTILISATION • BEDIENUNGSANLEITUNG
ISTRUZIONI D'USO**

EG

ES

F

D

I

This air conditioner uses the new refrigerant R410A

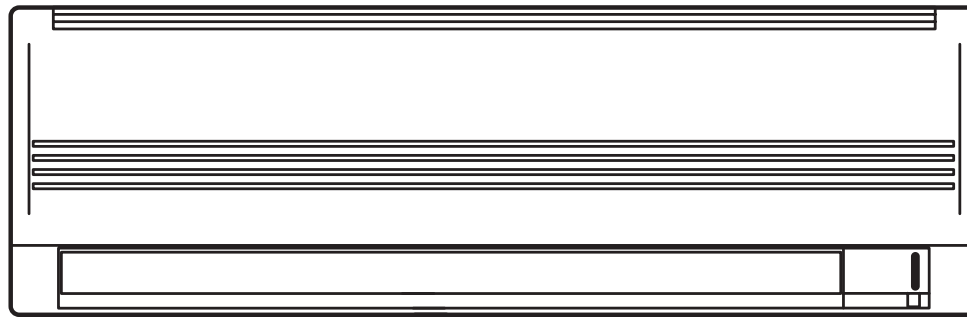

**MCAF78MR5I
MCAF98MR5I
MCAF128MR5I**

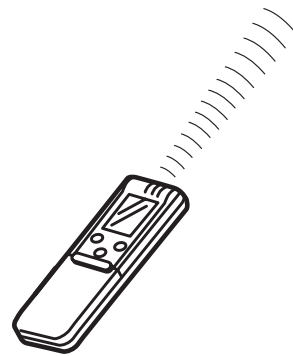

**Save These Instructions • Guardéis estas instrucciones
Conserver ce notice d'utilisation • Bewahren Sie bitte diese Bedienungsanleitung auf
Conservate queste istruzioni**

**Split air conditioner system • Acondicionador de aire de consola partida sistema split
Climatiseurs split • Split-klimagerät • Condizionatore d'aria split system**

Features

This air conditioner is an inverter type unit that automatically adjusts capability as appropriate. Details on these functions are provided below; refer to these descriptions when using the air conditioner.

- **Microprocessor Controlled Operation**
The interior compartment of the remote control unit contains several features to facilitate automatic operation, easy logically displayed for easy use.
- **Simple One-touch Wireless Remote Control**
The remote control unit has several features to facilitate automatic operation.
- **24-Hour ON or OFF Timer**
This timer can be set to automatically turn the unit on or off at any time within a 24 hour period.
- **1-Hour OFF Timer**
This timer can be set to automatically turn off the unit at any time after one hour.
- **Night Setback**
This function saves energy by controlling operation to provide a quieter operating sound than normal.
- **Automatic and 3-step Fan Speed**
Auto/High/Medium/Low
- **Air Sweep Control**
This function moves a flap up and down in the air outlet, directing air in a sweeping motion around the room and providing comfort in every corner.
- **Auto. Flap Control**
This automatically sets the flap to the optimum position during heating, cooling, and drying operation.
- **Hot Start Heating System**
Right from the start, the air is warm and comfortable. This system prevents any cold blasts at the beginning while the heat pump is warming up, or even defrosting.
- **Automatic Restart Function for Power Failure**
Even when power failure occurs, preset programmed operation can be reactivated once power resumes.
- **High Power Operation**
If not in Auto Operation, the unit operates at maximum output for 30 minutes, regardless of the desired temperature.
The fan speed is 1 step above "High".
- **Quiet Operation**
The fan rotates slower than the fan speed setting to provide a quieter operating sound.
- **ION Operation**
While it is operating, the unit generates negative ions that freshen up the air in the room.
- **Anti-Mold Filter**
This unit is equipped with an anti-mold filter that inhibits the growth of mold and bacteria.
- **Air Clean Filter**
An air filter that eliminates unpleasant odors and cleans the air is available.
Purchase a replacement filter at your local dealer.
(model **STK-FDXB**)

Contents

	Page
Features	2
Product Information	3
Alert Symbols	3
Installation Location	4
Electrical Requirements	4
Safety Instructions	4
Names of Parts	5
Using the Remote Control Unit	10
Operation with the Remote Control Unit	12
1. Automatic Operation	12
2. Manual Operation	13
3. Adjusting the Fan Speed	14
4. Night Setback Mode	15
5. QUIET Mode	16
6. HIGH POWER Mode	16
7. ION Mode	16
Special Remarks	17
Setting the Timer	18
Using the 1-Hour OFF Timer	20
Tips for Energy Saving	20
Adjusting the Airflow Direction	21
Operation without the Remote Control Unit	22
Care and Cleaning	22
Troubleshooting	25
Operating Range	25

Product Information

If you have problems or questions concerning your Air Conditioner, you will need the following information. Model and serial numbers are on the nameplate on the bottom of the cabinet.

Model No. _____ Serial No. _____

Date of purchase _____

Dealer's address _____

Phone number _____

DECLARATION OF CONFORMITY

This product is marked « **CE** » as it satisfies EEC Directive No. 89/336/EEC, 73/23/EEC, 93/68/EEC and 92/31/EEC.

This declaration will become void in case of mis-usage and/or from non observance though partial of Manufacturer's installation and/or operating instructions.

Alert Symbols

The following symbols used in this manual, alert you to potentially dangerous conditions to users, service personnel or the appliance:



This symbol refers to a hazard or unsafe practice which can result in severe personal injury or death.



This symbol refers to a hazard or unsafe practice which can result in personal injury or product or property damage.

Installation Location

- We recommend that this air conditioner be installed properly by qualified installation technicians in accordance with the Installation Instructions provided with the unit.
- Before installation, check that the voltage of the electric supply in your home or office is the same as the voltage shown on the nameplate.



WARNING

- Do not install this air conditioner where there are fumes or flammable gases, or in an extremely humid space such as a greenhouse.
- Do not install the air conditioner where excessively high heat-generating objects are placed.

Avoid: To protect the air conditioner from heavy corrosion, avoid installing the outdoor unit where salty sea water can splash directly onto it or in sulphurous air near a spa.

Electrical Requirements

1. All wiring must conform to the local electrical codes. Consult your dealer or a qualified electrician for details.
2. Each unit must be properly grounded with a ground (or earth) wire or through the supply wiring.
3. Wiring must be done by a qualified electrician.

Safety Instructions

- Read this Instruction Manual carefully before using this air conditioner. If you still have any difficulties or problems, consult your dealer for help.
- This air conditioner is designed to give you comfortable room conditions. Use this only for its intended purpose as described in this Instruction Manual.



WARNING

- Never use or store gasoline or other flammable vapor or liquid near the air conditioner — it is very dangerous.
- This air conditioner has no ventilator for intaking fresh air from outdoors. You must open doors or windows frequently when you use gas or oil heating appliances in the same room, which consume a lot of oxygen from the air. Otherwise there is a risk of suffocation in an extreme case.



CAUTION

- Do not turn the air conditioner on and off from the power mains switch. Use the ON/OFF operation button.
- Do not stick anything into the air outlet of the outdoor unit. This is dangerous because the fan is rotating at high speed.
- Do not let children play with the air conditioner.
- Do not cool or heat the room too much if babies or invalids are present.

Names of Parts

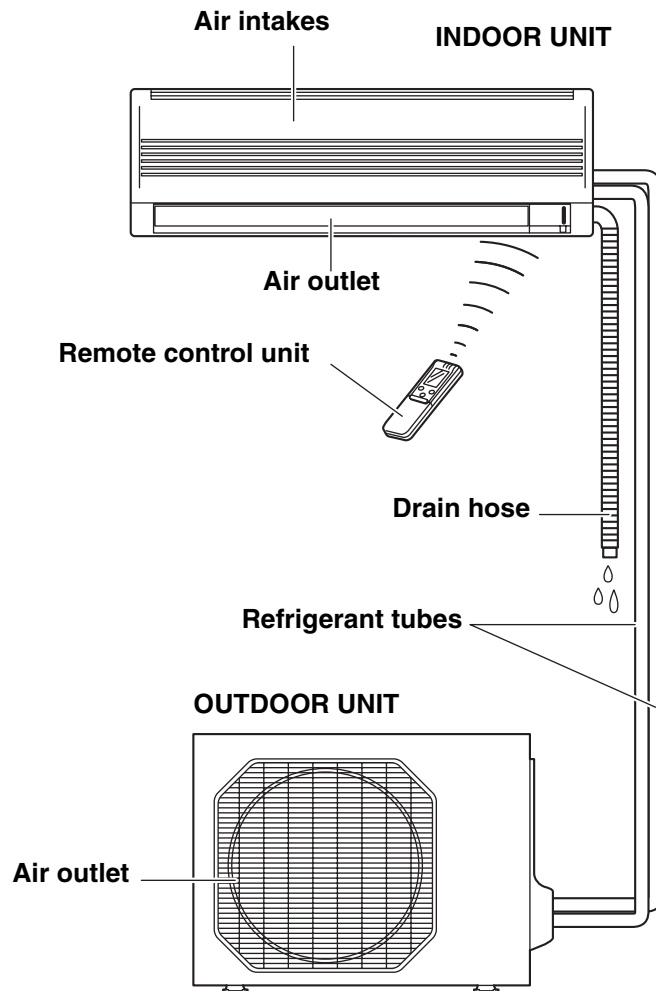

EG

NOTE

This illustration is based on the external view of a standard model. Consequently, the shape may differ from that of the air conditioner which you have selected.

This air conditioner consists of an indoor unit and an outdoor unit. You can control the air conditioner with the remote control unit.

Air Intake	Air from the room is drawn into this section and passes through air filters which remove dust.
Air Outlet	Conditioned air is blown out of the air conditioner through the air outlet.
Remote Control Unit	The wireless remote control unit controls power ON/OFF, operation mode selection, temperature, fan speed, timer setting, and air sweeping.
Refrigerant Tubes	The indoor and outdoor units are connected by copper tubes through which refrigerant gas flows.
Drain Hose	Moisture in the room condenses and drains off through this hose.
Outdoor (Condensing) Unit	The outdoor unit contains the compressor, fan motor, heat exchanger coil, and other electrical components.

Unit Display and Operation Button



IMPORTANT

Avoid using radio equipment such as mobile phone near (within 1 m) the remote control receiver. Some radio equipment may cause malfunction of the unit.

If the trouble happens, disconnect power and restart the air conditioner after a few minutes.

INDOOR UNIT

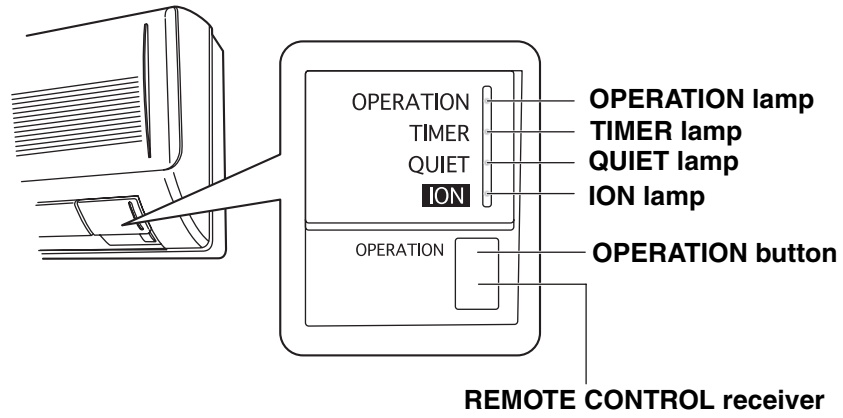

REMOTE CONTROL receiver	This section picks up infrared signals from the remote control unit (transmitter).
OPERATION button	When the remote control cannot be used, pressing this button enables heating and cooling operation. Each time this button is pressed, the type of operation conducted is indicated by the changing color of the OPERATION lamp. Press the button and select the lamp color that suits your preference for operation. Cooling operation (green) → Heating operation (red) → Stop (lamp off) ↑
OPERATION lamp	This lamp lights when the system is in the continuous AUTO (red or green), HEAT (red), DRY (orange), and COOL (green) mode. The OPERATION lamp lights up red and orange alternately when the system is defrosting.
TIMER lamp	This lamp lights when the system is being controlled by the timer.
QUIET lamp	This lamp lights during operation in the QUIET mode.
ION lamp	This lamp lights during operation in ION mode while the indoor unit is operating.

NOTE

The unit's display lamps are dimmed during operation in the NIGHT SETBACK mode.

Remote Control Unit (Display)

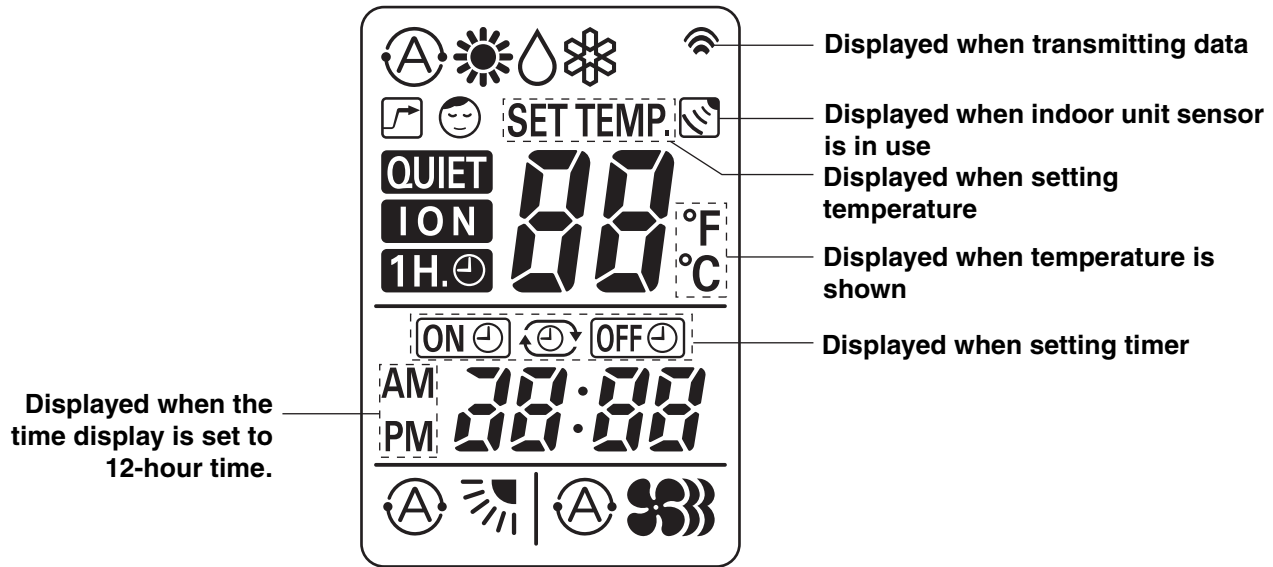

EG

Symbols

(1) Operation mode		(4) Timer	
AUTO		24-hour clock with ON/OFF program Timer.....	
HEAT		ON Timer.....	
MILD DRY		OFF Timer.....	
COOL.....		1-hour OFF Timer.....	
(2) Fan speed		(5) NIGHT SETBACK	
Automatic operation			
HIGH		(6) Confirmation of transmission	
MEDIUM.....			
LOW		(7) Auto. flap indication	
(3) Temperature setting		Flap angle indication	
16 – 30 °C		Sweep indication	
When set to 28 °C temperature indication.....			
		(8) High power operation	
		(9) Quiet operation.....	
		(10) ION operation.....	



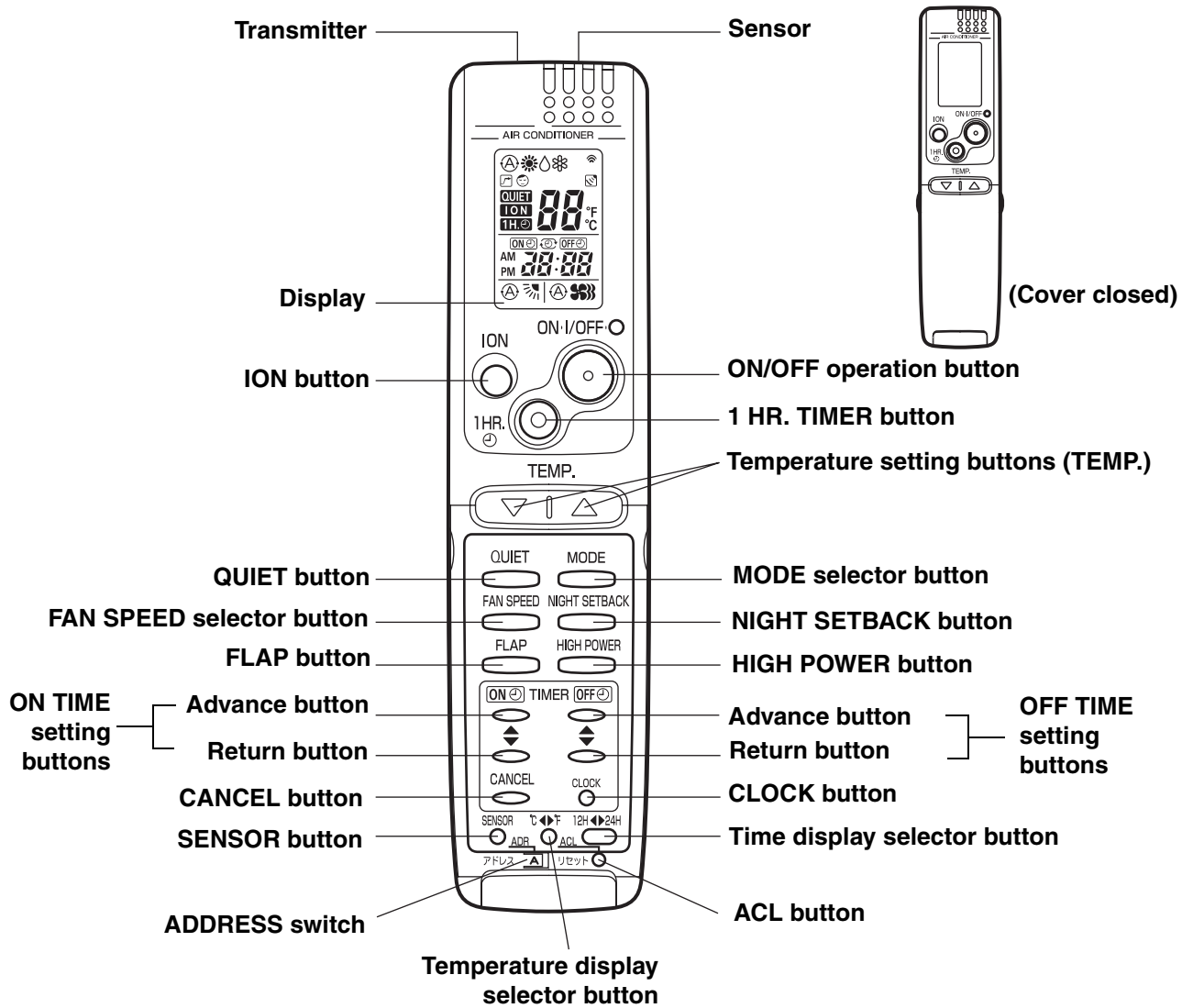















Remote Control Unit

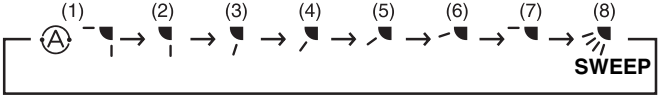

NOTE The illustration above pictures the remote control unit after the cover has been opened.

Transmitter	When you press the buttons on the remote control unit, the mark appears in the display to transmit the setting changes to the receiver in the air conditioner.
Sensor	A temperature sensor inside the remote control unit senses the room temperature.
Display	Information on the operating conditions is displayed while the remote control unit is switched on. If the unit is turned off, FLAP setting and FAN SPEED setting are not displayed.
ION button	ION : This button is for turning the negative ions generated during operation on and off.
ON/OFF operation button	This button is for turning the air conditioner on and off.
1 HR. TIMER button (1-HOUR OFF TIMER)	1H. : When you press this button, regardless of whether the unit is operating or stopping, the unit operates for one hour and then shuts down.

Remote Control Unit (continued)

<p>Temperature setting buttons (TEMP.)</p>	<p>Press the  button to increase the set temperature. Press the  button to reduce the set temperature. The temperature setting changes by 1 °C or 2 °F each time one of the TEMP. buttons is pressed.</p>
<p>QUIET button</p>	<p>QUIET : When you press this button, the fan rotates slower than the fan speed setting to provide a quieter operating sound.</p>
<p>MODE selector button (AUTO)</p> <p>(HEAT)</p> <p>(DRY)</p> <p>(COOL)</p> <p>NOTE</p>	<p>Use this button to select AUTO, HEAT, DRY or COOL mode.</p> <p> : The air conditioner calculates the difference between the thermostat setting and room temperature, and automatically selects “COOL” or “HEAT” mode as appropriate.</p> <p> : The air conditioner makes the room warmer.</p> <p> : The air conditioner reduces the humidity in the room.</p> <p> : The air conditioner makes the room cooler.</p> <p>When multiple indoor units are used and units in other rooms are already operating, they will be set to the same mode of operation as the operating indoor units.</p>
<p>FAN SPEED selector button</p>	<p> : The air conditioner automatically decides the fan speeds.</p> <p> : High fan speed</p> <p> : Medium fan speed</p> <p> : Low fan speed</p>
<p>NIGHT SETBACK button</p>	<p>For details, see “4. Night Setback Mode”. When you press this button in the HEAT, DRY or COOL mode, the  mark appears in the display, and the remote control unit will automatically adjust the set temperature to save energy.</p>
<p>FLAP button</p> <p>NOTE</p>	<p>Press this button either to select the setting of the airflow direction to the auto. flap in each mode or one of the six possible positions manually or to select the sweep function which moves the flap up and down automatically.</p> <p> : Auto flap setting: If selected in a heating operation, the flap is set to position (3) in the following chart. If selected in a cooling or dry operation, the flap is set at position (7) in the following chart.</p> <p> : The airflow direction can be set manually. (six positions)</p> <p> : The flap moves up and down automatically.</p> <p>When you press the FLAP button, the air flow direction will be changed one by one as follows.</p> <div style="text-align: center;">  </div>
<p>HIGH POWER button</p>	<p> : If this button is pressed during HEAT, DRY or COOL operation, the unit operates at maximum output for 30 minutes, regardless of the desired temperature. The fan speed is 1step above “HIGH”.</p>
<p>ON TIME/OFF TIME setting buttons</p>	<p>No display: The timer does not operate.</p> <p> : The air conditioner starts at the set time.</p> <p> : The air conditioner stops at the set time.</p> <p> : The air conditioner stops and starts, or starts and stops, at the set times every day. For details, see “Setting the Timer”.</p>

EG

Remote Control Unit (continued)

<p>SENSOR button</p> <p>NOTE</p>	<p>When you press this button (use a small-tipped object such as a ballpoint pen), the  mark will appear at the display. And the room temperature is detected by the sensor which is built into the indoor unit and the air conditioner is controlled accordingly.</p> <p>If the remote control is located near a heat source, such as a space heater or in direct sunlight, press the SENSOR button to switch to the sensor on the indoor unit.</p>
<p>Temperature Display Selector button</p>	<p>This switches the temperature display between °C and °F.</p>
<p>Time Display Selector button</p>	<p>This switches the time display between 24-hour time and 12-hour time.</p>
<p>ACL button (ALL CLEAR)</p>	<p>Puts the remote control unit into pre-operation status. Always press this button after replacing the batteries.</p>
<p>ADDRESS switch</p>	<ul style="list-style-type: none"> • The address switch changes to prevent mixing of signals from remote control units when two air conditioners are installed next to each other. Normally, the address switch is set to A. For more information, please contact the dealer where you made the purchase. • Normally, the tabs on the remote control unit should not be bent.

NOTE The remote control unit sends the temperature signal to the air conditioner regularly at five minute intervals. If the signal from the remote control unit stops for more than 15 minutes due to the loss of the remote control unit or other trouble, the air conditioner will switch to the temperature sensor which is built into the indoor unit and control the room temperature. In these cases, the temperature around the remote control unit may differ from the temperature detected at the air conditioner's position.

Using the Remote Control Unit

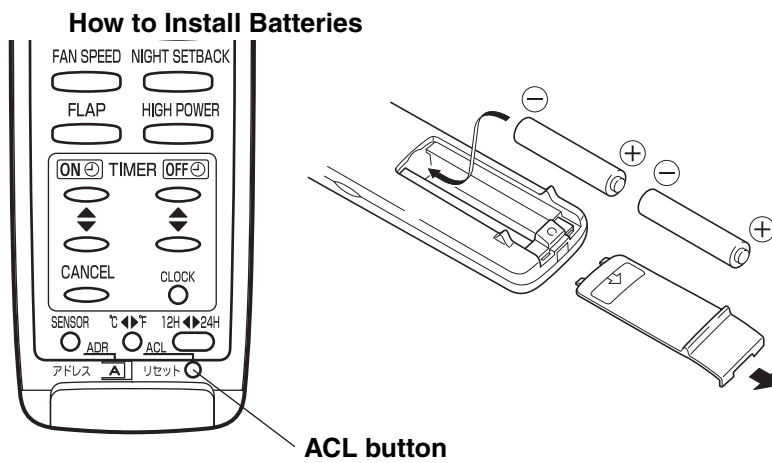

1. Slide the cover in the direction indicated by the arrow and remove it.
2. Install two AAA alkaline batteries. Make sure the batteries point in the direction marked in the battery compartment.
3. Use a thin object such as the tip of a pen to press the ACL button.

- NOTE**
- The batteries last about six months, depending on how much you use the remote control unit. Replace the batteries when the remote control unit's display fails to light, or when the remote control cannot be used to change the air conditioner's settings.
 - Use two fresh leak-proof type-AAA alkaline batteries.
 - In replacing batteries, follow the instructions as mentioned in the sub-section "How to Install Batteries".
 - If you do not use the remote control unit more than 1 month, take out the batteries.

Using the Remote Control Unit (continued)

How to Use the Remote Control Unit

When using the remote control unit, always point the unit's transmitter head directly at the air conditioner's receiver.

Air conditioner (Indoor unit)

Remote control unit

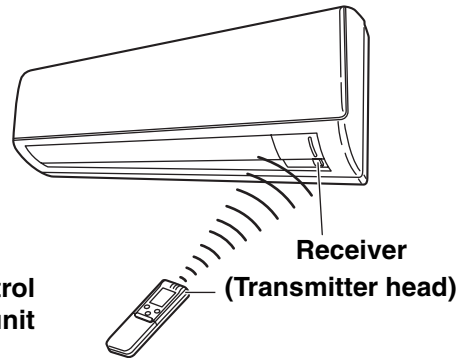

EG

Remote Control Unit Installation Position

The remote control unit may be operated either from a non-fixed position or from a wall-mounted position. To ensure that the air conditioner operates correctly, DO NOT install the remote control unit in the following places:

DO NOT

- In direct sunlight
- Behind a curtain or other places where it is covered
- More than 8 m away from the air conditioner
- In the path of the air conditioner's airstream
- Where it may become extremely hot or cold
- Where it may be subject to electrical or magnetic noise
- Where there is an obstacle between the remote control unit and air conditioner (since a check signal is sent from the remote control unit every 5 minutes)

Mounting the Remote Control Unit

Before mounting the remote control unit, press the ON/OFF operation button at the mounting location to make sure that the air conditioner operates from that location. The indoor unit should make a beeping sound to indicate that it has received the signal.

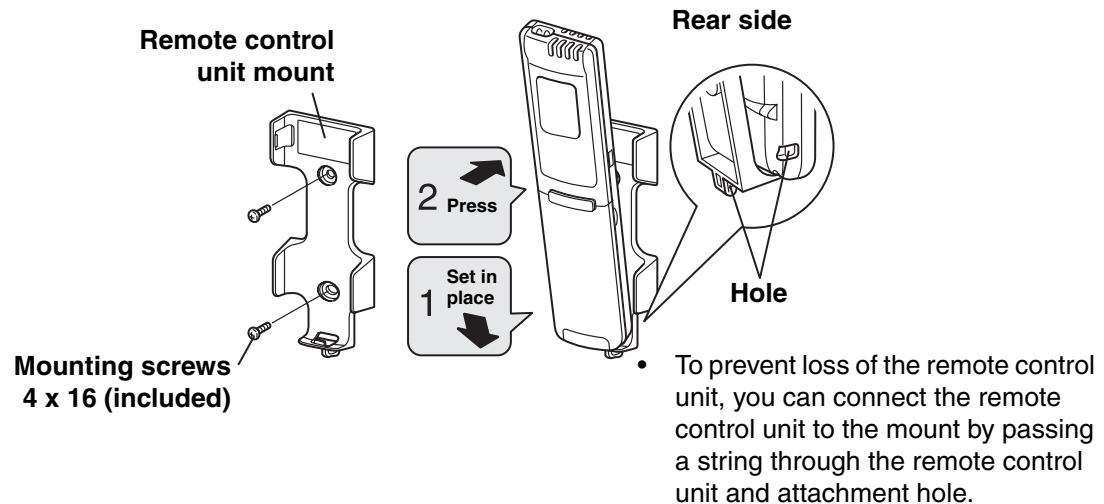

To take out the remote control unit, pull it forward.

When Holding the Remote Control Unit

- When using the remote control unit and during air conditioner operation, the transmitter on the remote control unit should be pointed toward the receiver on the indoor unit.
- Make sure that there are no objects between the remote control unit and receiver which could block the signal.

Operation with the Remote Control Unit

1. Automatic Operation

The air conditioner calculates the difference between the thermostat setting and room temperature, and automatically selects "COOL" or "HEAT" mode as appropriate.

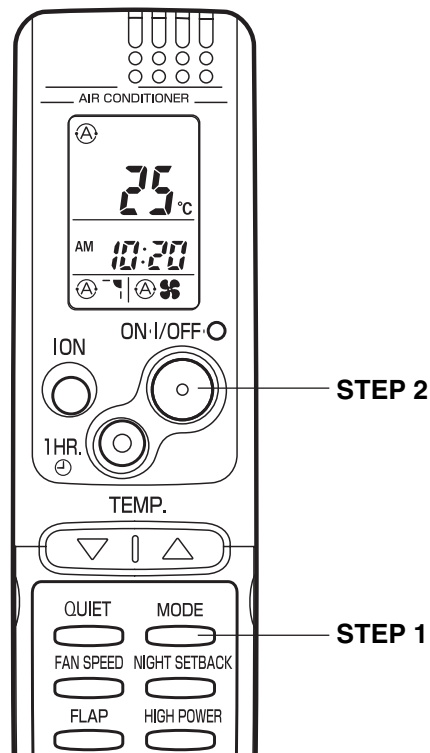

NOTE Check that the circuit breaker on the power panel is turned on.

Once Ⓐ mode is selected and the unit is preset by following the steps below, you can have the air conditioner automatically bring the room to the desired temperature simply by pressing the ON/OFF operation button.

STEP 1	Press the MODE selector button to Ⓐ .
STEP 2	Press the ON/OFF operation button.

To stop the air conditioner, press the ON/OFF operation button again.

NOTE

- To change the temperature setting; press the temperature setting buttons and change the setting to the desired temperature.

Operation with the Remote Control Unit (continued)

2. Manual Operation

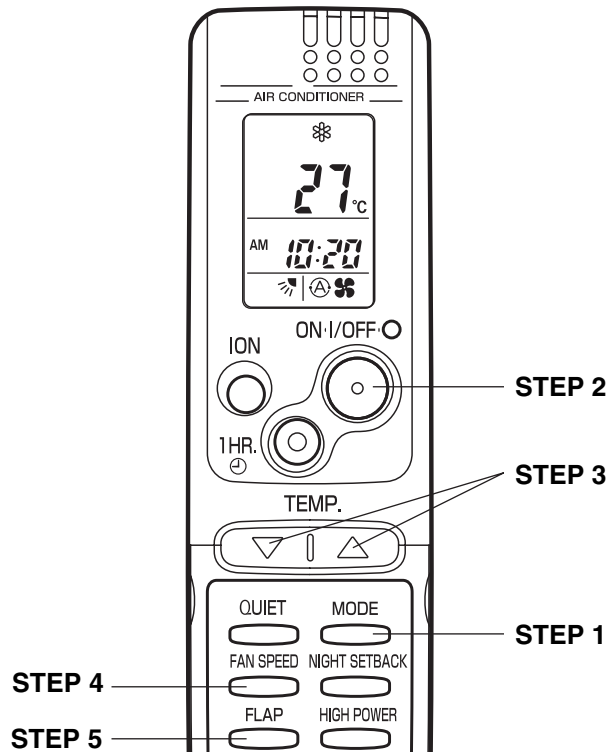

NOTE Check that the circuit breaker on the power panel is turned on.

If the automatic operation settings of the unit do not meet your needs, press the setting buttons as described below and change the settings as desired.

STEP 1	Press the MODE selector button and select the desired mode. For heating operation → ☀ For dehumidifying operation → 💧 For cooling operation → ❄
STEP 2	To start the air conditioner, press the ON/OFF operation button.
STEP 3	Press the TEMP. setting buttons to change the temperature setting to the desired temperature. Adjustable temperature range: 30 °C max. or 86 °F max. 16 °C min. 60 °F min.
STEP 4	Set the FAN SPEED selector button to the setting you want.
STEP 5	Press the FLAP button and set the airflow direction as desired. (Refer to "Adjusting the Airflow Direction" on page 21.)

To stop the air conditioner, press the ON/OFF operation button again.

NOTE When multiple indoor units are used and units in other rooms are already operating, they will be set to the same mode of operation as the operating indoor units.

Operation with the Remote Control Unit (continued)

NOTE



- Choose the best position in the room for the remote control unit, which also acts as the sensor for room comfort and transmits the operating instructions. Once you've found this best position, always keep the remote control unit there.
- This appliance has a built-in 5-minute time delay circuit to ensure reliable operation. When the operation button is pressed, the compressor will start running within three minutes. In the event of power failure, the unit will stop.

3. Adjusting the Fan Speed

A. Automatic fan speed

Simply set the FAN SPEED selector button to the  position. This automatically sets the best fan speed for the room temperature.

B. Manual fan speed

If you want to adjust fan speed manually during operation, just set the FAN SPEED selector button as desired. [, , or 

Operation with the Remote Control Unit (continued)

4. Night Setback Mode

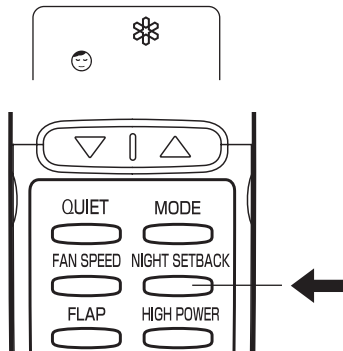

Night Setback Mode is used for saving energy.

Press the NIGHT SETBACK button while operation.
The ☺ mark appears in the display.

To release the night setback function, press the NIGHT SETBACK button again.

EG

A. In Cooling and DRY Mode: (☼ and ☹)

When the night setback mode is selected, the air conditioner automatically raises the temperature setting 1 °C when 30 minutes have passed after the selection was made, and then another 1 °C after another 30 minutes have passed, regardless of the indoor temperature when night setback was selected. This enables you to save energy without sacrificing comfort. This function is convenient when gentle cooling is needed.

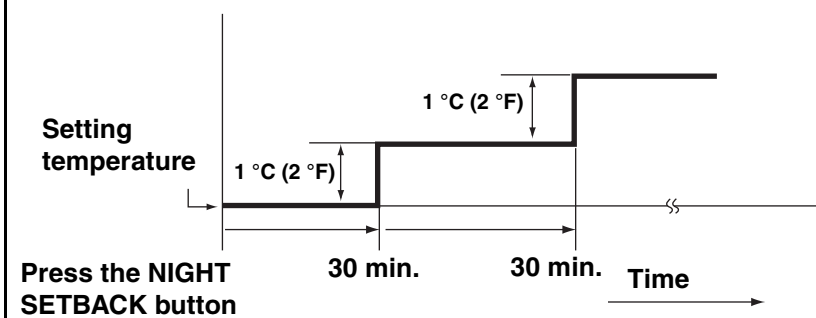

B. In Heating Mode: (☼)

When the night setback mode is selected, the air conditioner automatically lowers the temperature setting 2 °C when 30 minutes have passed after the selection was made, and then another 2 °C after another 30 minutes have passed, regardless of the indoor temperature when night setback was selected. This enables you to save energy without sacrificing comfort. This function is convenient when gentle heating is needed.

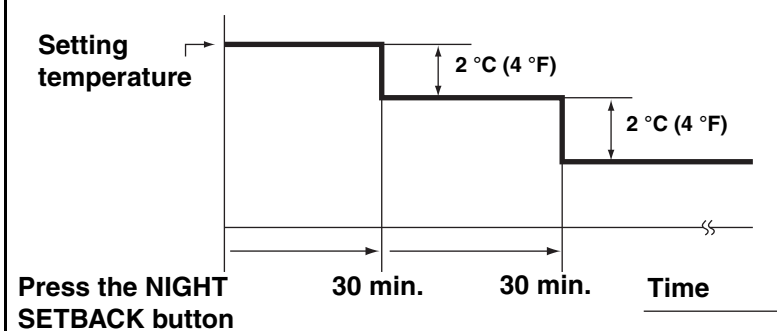

Operation with the Remote Control Unit (continued)

5. QUIET Mode

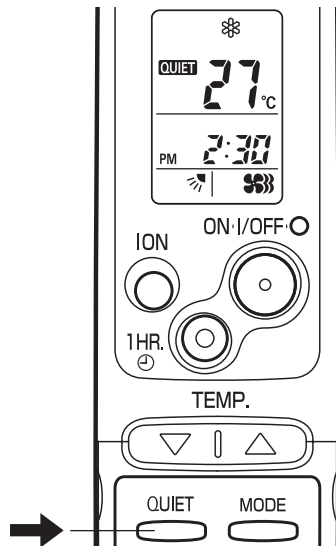

QUIET Mode is used to reduce the fan sound of the indoor unit.

Press the QUIET button.
The **QUIET** mark appears in the display.

To cancel, press QUIET button again.

- In QUIET Mode, the fan rotates at a slower speed than the fan speed setting.
- If the unit is already operating with a very low airflow, the fan sound may not change even if the QUIET button is pressed.

6. HIGH POWER Mode

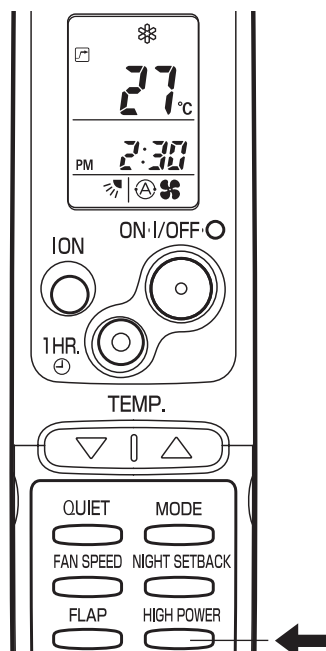

HIGH POWER mode can be used to increase the output of the indoor unit for all operation modes except automatic operation.

Press the HIGH POWER button.
The  mark appears in the display.

To cancel, press HIGH POWER button again.

- When the HIGH POWER button is pressed, the unit operates at maximum output for 30 minutes, regardless of the desired temperature. The fan speed is 1 step above "High".
- HIGH POWER Mode cannot be used when the operation mode is Automatic Operation.
- QUIET Mode and HIGH POWER Mode cannot be used at the same time.

- NOTE**
- When set to High fan speed during heating operation, the fan runs at High fan speed even though the  mark is displayed.
 - Depending on the operating conditions, the fan speed may be increased by a small amount only.

7. ION Mode

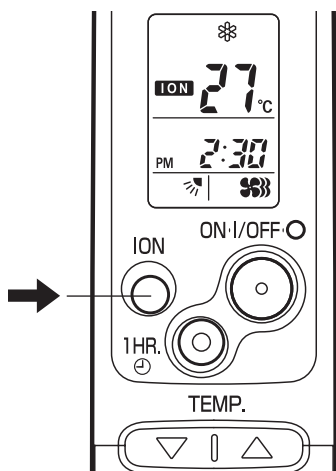

The ION mode is used during operation to generate negative ions that freshen up the air in the room.

Press the ION button.
The **ION** mark appears in the display.

To cancel, press ION button again.

- The indoor unit's ION lamp lights up while negative ions are being generated.
- ION "on" is the remote control unit's initial setting.
- The negative ions are generated from the negative ion generator.

Special Remarks

“DRY” (☾) Operation

How it works?

- Once the room temperature reaches the level that was set, the unit's operation frequency is changed automatically.
- During DRY operation, the fan speed automatically runs at lower speed for providing a comfortable breeze.
- “DRY” operation is not possible if the indoor temperature is 15 °C or less.

EG

Heating (☀) Operation

Heating performance

- Because this air conditioner heats a room by drawing in the heat of the outside air (heat pump system), the heating efficiency will fall off when the outdoor temperature is very low. If sufficient heat cannot be obtained with this air conditioner, use another heating appliance together with it.

Defrosting

- When the outdoor temperature is low, frost or ice may form on the heat exchanger coil, reducing heating performance. When this happens, a microcomputer defrosting system operates. At the same time, the fan on the indoor unit stops and the OPERATION lamp lights red and orange alternately until defrosting is completed. Heating operation restarts after several minutes. (This interval will vary slightly depending upon the outdoor temperature and the way in which frost forms.)

Cold draft prevention

- For several minutes after the start of heating operation, the indoor fan runs at a lower speed until the indoor heat exchanger coil has warmed up sufficiently. However, the fan may remain stopped when the room temperature is low. This is because the COLD DRAFT PREVENTION SYSTEM is in operation.

Power failure during operation

- In the event of power failure, the unit will stop. When the power is resumed, the unit will restart automatically within 15 minutes by the remote control unit.

Clicking Sound

Clicking sound is heard from the air conditioner

- In heating or cooling operation, any plastic parts may expand or shrink due to a sudden temperature change. In this event, a clicking sound may occur. This is normal, and the sound will soon disappear.

Remote Control Unit

- The remote control unit sends the setting condition signals to the air conditioner regularly at five minute intervals.

Setting the Timer

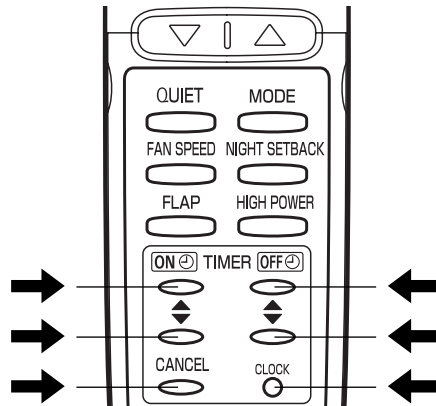

NOTE In the descriptions below, the following settings are used for the temperature and time indicator selector button on the bottom front section of the remote control.

- Temperature: °C
- Time: AM, PM

1. How to set the present time

(Example) To set to 10:30 pm.

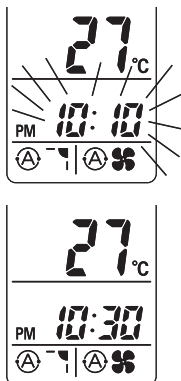

Operation	Indication
1. Press the CLOCK button once if the time indicator is not flashing.	The time indication alone flashes.
2. Press the Advance, Return (▲, ▼) button until PM 10:30 is displayed.	The time can be set in 1-minute increments. Holding down the button advances the time rapidly in 10-minute increments.
3. Press the CLOCK button again.	This completes the setting of the current time.

2. How to set the OFF time

(Example) To stop the air conditioner at 11:00 am.

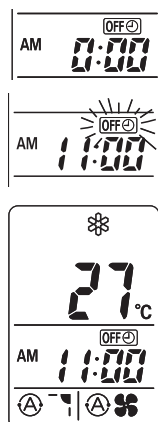

1. Press the OFF TIME setting button once.	The timer OFF TIME indication is displayed, and the present OFF time is shown.
2. Press the Advance, Return (▲, ▼) button until AM 11:00 is displayed.	The timer OFF TIME indication blinks. The time can be set in 10-minute increments. Holding down the button advances the time rapidly in 10-minute increments.
3. Wait a few seconds, and then the setting is complete.	The timer OFF TIME indication stops blinking and the present time is displayed.

Setting the Timer (continued)

3. How to set the ON time

(Example) To start operation at 7:10 am.

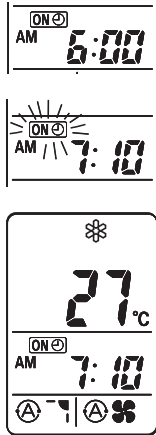

Operation	Indication
1. Press the ON TIME setting button once.	The timer ON indication is displayed, and the present ON time is shown.
2. Press the Advance, Return (▲, ▼) button until AM 7:10 is displayed.	The timer ON indication blinks. The time can be set in 10-minute increments. Holding down the button advances the time rapidly in 10-minute increments.
3. Wait a few seconds, and then the setting is complete.	The timer ON indication stops blinking and the present time is displayed.

EG

4. How to set DAILY ON/OFF REPEAT timer

(Example) To start operation at 7:10 am. and stop the air conditioner at 11:00 am.

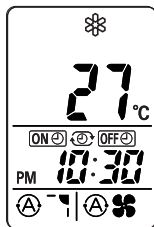
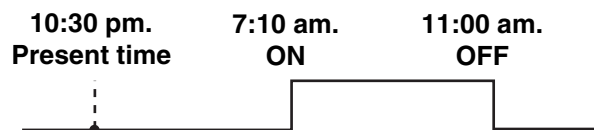

1. Set the timer ON/OFF times as shown in 2-1, 2, 3 and 3-1, 2, 3.	The present time 10:30 pm. and ON OFF are displayed.
--	--

NOTE

- The ON/OFF combination timer uses the current time as the reference, and it is activated starting from whichever set time comes first.
- With the ON/OFF combination timer, the settings are repeated every day.
- You can check the timer ON/OFF times after you have set them by pressing the ON TIME and OFF TIME setting buttons.

To cancel a timer program

- Press the CANCEL button.
- When either an ON or OFF timer is to be canceled, press the button corresponding to the timer whose program is to be canceled, and then press the CANCEL button.

NOTE

- The airflow direction, fan speed and temperature setting can be changed after a timer program has been set even when the unit is stopped. Even when operation is stopped during an ON timer program, the unit will start operating when the set time is reached provided that the program is not canceled.
- When the ON timer and OFF timer are set to the same time, the timer operates as if it is turned off.

Using the 1-Hour OFF Timer

1. 1-Hour OFF Timer

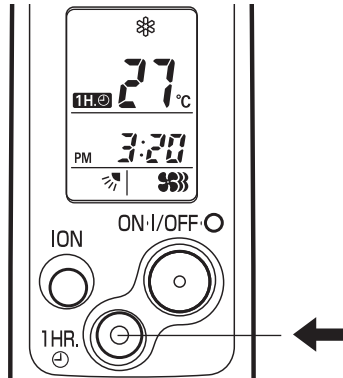

This function causes the unit to operate for one hour and then stop, regardless of whether the unit is on or off when this button is pressed. The **1H.** indicator in the display indicates that this function is operating.

Setting procedure:

Regardless of whether the unit is operating or stopped, press the 1 HR. TIMER button.

1H. appears in the display.

Cancellation procedure:

Press the ON/OFF operation button to turn the unit off, wait for the unit to stop operating, and then press the ON/OFF operation button again.

The 1-Hour Timer function is now cancelled and the unit operates normally.

NOTE

- If, while the 1-Hour Timer function is operating, the 1HR. TIMER button is pressed once to cancel the function and then again, the unit continues to operate for one hour from that point in time and then stops.
- It is not possible to use the OFF Timer and 1-Hour OFF Timer together. Whichever function is set last takes precedence. If the 1 HR. TIMER button is pressed while the TIMER OFF function operates, the OFF Timer is cancelled and the unit will stop operating one hour later.

2. Operation together with the DAILY ON/OFF REPEAT Timer

The 1-Hour OFF Timer setting is given priority over the DAILY ON/OFF REPEAT setting.

Tips for Energy Saving

- Do not**
- **Block the air intake and outlet of the unit. If they are obstructed, the unit will not work well, and may be damaged.**
 - Let direct sunlight into the room. Use sunshades, blinds or curtains. If the walls and ceiling of the room are warmed by the sun, it will take longer to cool the room.
- Do**
- Always try to keep the air filter clean. (Refer to "Care and Cleaning".) A clogged filter will impair the performance of the unit.
 - To prevent conditioned air from escaping, keep windows, doors and any other openings closed.

Adjusting the Airflow Direction

EG

- 1. Horizontal** The horizontal airflow can be adjusted by moving the vertical vanes with your hands to the left or right.

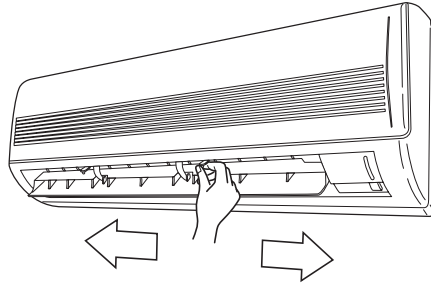

CAUTION

When the humidity is high, the vertical vanes should be in the front position during the cooling or dehumidifying operation. If the vertical vanes are positioned all of the way to the right or left, condensation may begin to form around the air vent and drip down.

- 2. Vertical** The vertical airflow can be adjusted by moving the flap with the remote control unit. Do not move the flap with your hands. Confirm that the remote control unit has been turned on. Use the FLAP button to set either the sweep function or one of the six airflow direction settings.

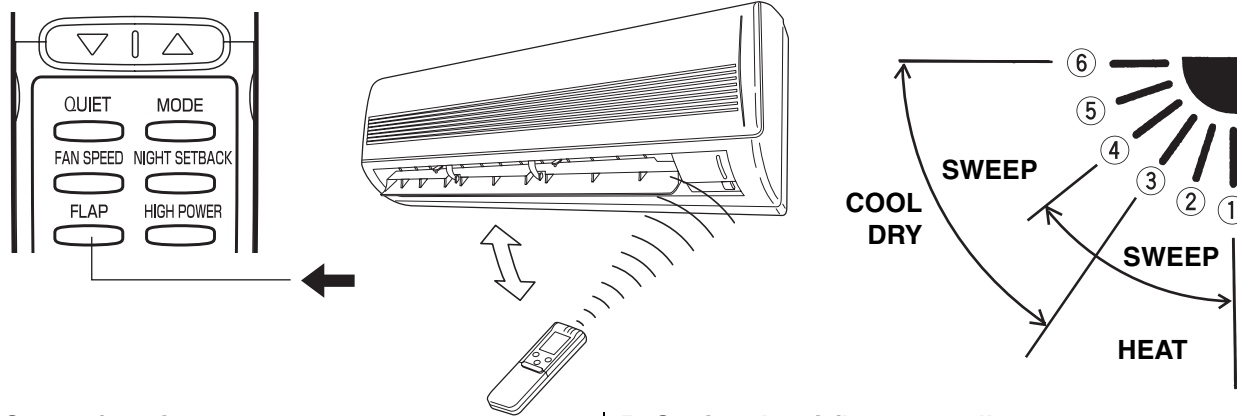

A. Sweep function



The flap starts moving up and down to deliver air over the sweep range.

C. Auto flap function



The flap is set to the recommended position.

B. Setting the airflow manually



Referring to the above illustration, use the FLAP button to set the airflow direction within the range used during the heating, cooling, or dehumidifying operation.

NOTE

- The flap automatically closes when the unit is off.
- During the heating operation, the fan speed will be very low and the flap will be in the horizontal position (position ⑥) until the air being blown out of the unit begins to warm. Once the air warms up, the flap position and fan speed change to the settings specified with the remote control.



CAUTION

- Use the FLAP button on the remote control to adjust the position of the flap. If you move the flap by hand, the flap position according to the remote control and the actual flap position may no longer match. If this should happen, shut off the unit, wait for the flap to close, and then turn on the unit again; the flap position will now be normal again.
- Do not have the flap pointed down during cooling operation. Condensation may begin to form around the air vent and drip down.

Operation without the Remote Control Unit

INDOOR UNIT

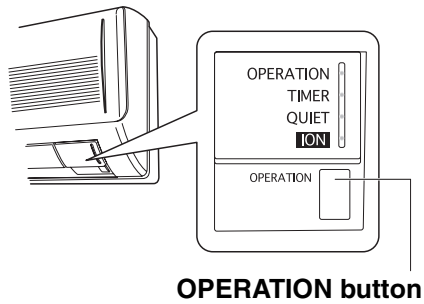

If you have lost the remote control unit or it has trouble, follow the steps below.

When the air conditioner is not running

Each time the OPERATION button is pressed, the type of operation conducted is indicated by the changing color of the OPERATION lamp. Press the button and select the lamp color that suits your preference for operation.

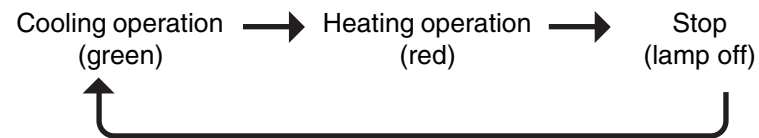

NOTE

The temperature is set to the room temperature minus 2°C during the cooling operation and to the room temperature plus 2°C during the heating operation, and the fan speed and flap are set to Auto.

Care and Cleaning



WARNING

1. For safety, be sure to turn the air conditioner off and also to disconnect the power before cleaning.
2. Do not pour water on the indoor unit to clean it. This will damage the internal components and cause an electric shock hazard.

Casing and Grille (Indoor Unit)

Clean the casing and grille of the indoor unit with a vacuum cleaner brush, or wipe them with a clean, soft cloth.

If these parts are stained, use a clean cloth moistened with a mild liquid detergent. When cleaning the grille, be careful not to force the vanes out of place.



CAUTION

1. Never use solvents, or harsh chemicals when cleaning the indoor unit. Do not wipe the plastic casing using very hot water.
2. Some metal edges and the fins are sharp and may cause injury if handled improperly; be especially careful when you clean these parts.
3. The internal coil and other components of the outdoor unit must be cleaned every year. Consult your dealer or service center.

Care and Cleaning (continued)

Anti-Mold Filter The anti-mold filter behind the air intake grille should be checked and cleaned at least once every two weeks.

How to remove the anti-mold filter

1. Grasp both ends of the air intake grille, and remove it by opening towards the front and pulling towards you.

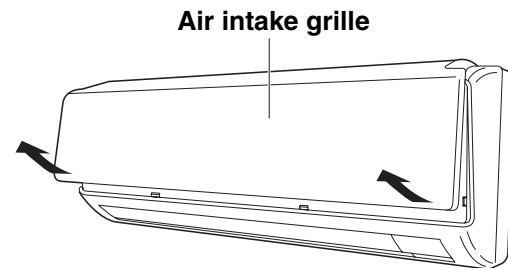

EG

2. Remove the anti-mold filter attached to the rear of the air intake grille.

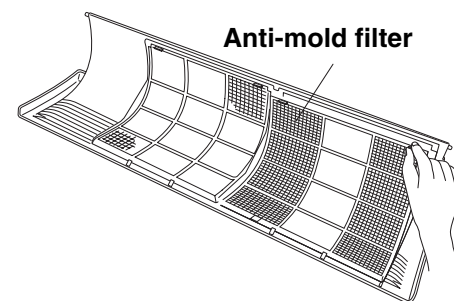

Cleaning Use a vacuum cleaner to remove light dust. If there is sticky dust on the filter, wash the filter in lukewarm, soapy water, rinse it in clean water, and dry it.

How to replace the anti-mold filter

1. With the FRONT mark of the anti-mold filter at the front, align the two indentions near the mark with the hooks at the rear of the air intake grille, and then mount the anti-mold filter.

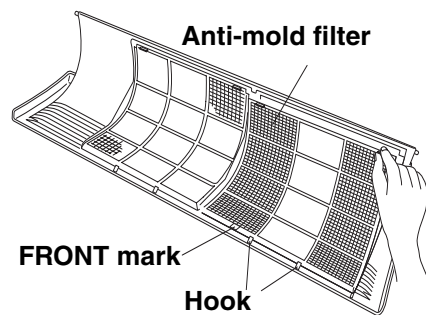

2. Allow the edge of the air intake grille to slide into the top of the indoor unit, and then insert it all the way inside.

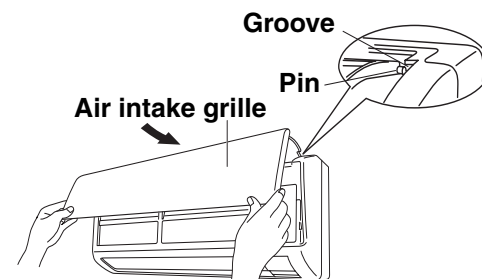

3. Press in the bottom right and left corners of the air intake grille to attach the indoor unit.

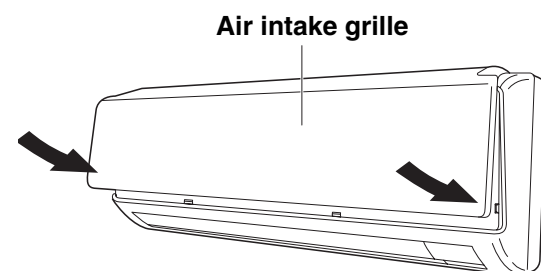

NOTE

Attach so that the round pins at the top right and left corners of the air intake grille are inserted into the grooves at the top right and left of the indoor unit.

Care and Cleaning (continued)

Air Clean Filter The air clean filter removes dust and dirt from the air, and reduces odors and smoke from tobacco.



WARNING

This air clean filter cannot remove harmful gases or vapors nor ventilate air in the room. You must open doors or windows frequently when you use gas or oil heating appliances. Otherwise there is a risk of suffocation in extreme cases.

How to install the air clean filter

The air clean filter needs to be installed behind the air intake grille.

1. Remove the air intake grille.
2. Install the air clean filter in the position shown in the figure.
3. Remount the air intake grille.

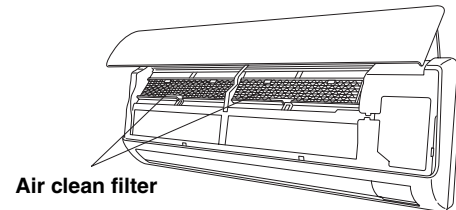

Air clean filter

How to clean the air clean filter

- In general, the filter should be sucked to remove dust in low fan speed of a vacuum cleaner once every three months.
- If there is heavily grime on the filter, soak the filter in lukewarm water with neutral detergent diluted 1:500 for 1 to 2 minutes then wash it.
- Rinse the filter in clean water, then let it dry on the towel in room temperature.

NOTE

- Do not bend nor give excessive force onto the air clean filter.
- If the filter surface is heavily blocked with dirt or damaged, replace it with new one. Purchase a replacement filter at your local dealer. (model **STK-FDXB**)

Cleaning the main unit and remote control unit

- Wipe clean using a soft, dry cloth.
- To remove stubborn dirt, moisten a cloth in warm water no hotter than 40 °C, wring thoroughly, and then wipe.
- The air intake grille can be removed in order to wash it with water.

Removing and remounting the air intake grille

Refer to "How to remove the anti-mold filter" and "How to replace the anti-mold filter" on page 23.



CAUTION

When using a footstool or the like, be careful not to let it tip over.

Washing the grille with water

- Clean the grille gently using a soft sponge, or the like. Then wipe away any remaining moisture.
- Neutral detergent may be used to remove stubborn dirt. Then rinse thoroughly with water and wipe away any remaining moisture.

Cleaning the negative ion generator

Follow the steps below when the generator has become dirty.



WARNING

For safety, be sure to turn the air conditioner off and also to disconnect the power before cleaning.

Remove the dust on the negative ion generator.

- Use a toothbrush, etc. to dust off the end.
- Use a cotton swab, etc., to clean around the generator inside the plastic case, taking care not to touch the electrodes.

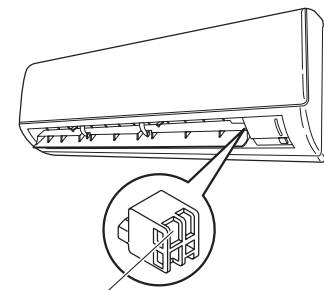

Negative ion generator
(metal electrodes inside plastic case)

NOTE

- During use, the negative ion generator and other metal parts may become discolored: this is normal and not indicative of malfunctioning.
- If the dirt on and around the negative ion generator is left to build up, a puffing or sputtering sound will eventually be heard. In this case, clean the generator immediately.
- Do not apply excessive force while performing maintenance.

Troubleshooting

If your air conditioner does not work properly, first check the following points before requesting service. If it still does not work properly, contact your dealer or service center.

Trouble	Possible Cause	Remedy
Air conditioner does not run at all.	<ol style="list-style-type: none"> 1. Power failure. 2. Leakage circuit breaker tripped. 3. Line voltage is too low. 4. Batteries in remote control unit have run down. 	<ol style="list-style-type: none"> 1. Restore power. 2. Contact service center. 3. Consult your electrician or dealer. 4. Replace batteries.
OPERATION lamp blinks and air conditioner does not operate.	Trouble in system.	Contact service center.
Compressor runs but soon stops.	Obstruction in front of condenser coil.	Remove obstruction.
Poor cooling (or heating) performance.	<ol style="list-style-type: none"> 1. Dirty or clogged air filter. 2. Heat source or many people in room. 3. Doors and/or windows are open. 4. Obstacle near air intake or air discharge port. 5. Thermostat is set too high for cooling (or too low for heating). 6. (Outdoor temperature is too low for heating.) 	<ol style="list-style-type: none"> 1. Clean air filter to improve airflow. 2. Eliminate heat source if possible. 3. Shut them to keep the heat (or cold) out. 4. Remove it to ensure good airflow. 5. Set the temperature lower (or higher). 6. (Consult your dealer or try to use another heat appliance.)
Clicking sound is heard from the air conditioner.	In heating or cooling operation, any plastic parts may expand or shrink due to a sudden temperature change. In this event, a clicking sound may occur.	This is normal, and the sound will soon disappear.
OPERATION lamp lights but outdoor unit will not run.	The use of cellular phones near the air conditioner may cause disturbance to its normal operation.	<ol style="list-style-type: none"> 1. Turn off the power then restart the air conditioner after a while. 2. Consult your dealer.

EG

Operating Range

The air conditioner is operable within the temperature ranges as listed below:

	Temperature	Indoor air temperature	Outdoor air temperature
COOLING	Max.	32 °C DB / 23 °C WB	43 °C DB
	Min.	19 °C DB / 14 °C WB	19 °C DB
HEATING	Max.	27 °C DB	24 °C DB / 18 °C WB
	Min.	16 °C DB	- DB/ -15 °C WB

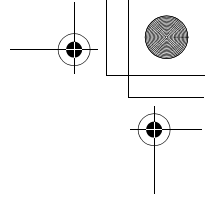
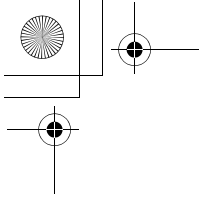

EG INFORMATION FOR CORRECT DISPOSAL OF THE PRODUCT IN ACCORDANCE WITH THE EUROPEAN DIRECTIVE 2002/96/EC

At the end of its working life this equipment must not be disposed of as an household waste.
It must be taken to special local community waste collection centres or to a dealer providing this service.
Disposing of an electrical and electronic equipment separately avoids possible negative effects on the environment and human health deriving from an inappropriate disposal and enables its components to be recovered and recycled to obtain significant savings in energy and resources.
In order to underline the duty to dispose of this equipment separately, the product is marked with a crossed-out dustbin.

I INFORMAZIONE PER IL CORRETTO SMALTIMENTO DEL PRODOTTO AI SENSI DELLA DIRETTIVA EUROPEA 2002/96/CE

Alla fine della sua vita utile questo apparecchio non deve essere smaltito insieme ai rifiuti domestici.
Deve essere consegnato presso appositi centri di raccolta differenziata oppure presso i rivenditori che forniscono questo servizio.
Smaltire separatamente un apparecchio elettrico ed elettronico consente di evitare possibili effetti negativi sull'ambiente e sulla salute umana derivanti da uno smaltimento inadeguato e permette di recuperare e riciclare i materiali di cui è composto, con importanti risparmi di energia e risorse.
Per sottolineare l'obbligo di smaltire separatamente queste apparecchiature, sul prodotto è riportato il simbolo del cassonetto barrato.
Lo smaltimento abusivo del prodotto da parte dell'utente comporta l'applicazione delle sanzioni amministrative di cui al D.Lgs. n. 22/1997 (articolo 50 e successivi).

F AVERTISSEMENT POUR L'ELIMINATION CORRECT DU PRODUIT AUX TERMES DE LA DIRECTIVE EUROPEENNE 2002/96/CE

Au terme de son utilisation cet équipement ne doit pas être éliminé avec les ordures ménagères.
Le produit doit être remis à l'un des centres de collecte sélective locaux ou auprès des revendeurs assurant ce service.
Éliminer séparément un équipement électrique et électronique permet d'éviter des potentielles retombées négatives pour l'environnement et la santé humaine dérivant d'une élimination incorrect et permet de récupérer les matériaux qui le composent dans le but d'une économie importante en termes d'énergie et de ressources.
Pour rappeler l'obligation d'éliminer séparément ces équipements, le produit porte le symbole d'un caisson à ordures barré.

D HINWEIS FÜR DIE KORREKTE ENTSORGUNG DES PRODUKTS IN ÜBEREINSTIMMUNG MIT DER EUROPÄISCHEN RICHTLINIE 2002/96/EG

Am Ende seiner Nutzzeit darf dieses Gerät nicht zusammen mit dem Hausmüll beseitigt werden.
Es darf zu den örtlichen Sammelstellen oder zu den Fachhändlern, die einen Rücknahmeservice anbieten, gebracht werden.
Die getrennte Entsorgung eines elektrischen und elektronischen Gerätes vermeidet mögliche negative Auswirkungen auf die Umwelt und die menschliche Gesundheit, die durch eine nicht vorschriftsmäßige Entsorgung bedingt ist. Zudem ermöglicht wird die Wiederverwertung der Materialien, aus denen sich das Gerät zusammensetzt, was wiederum eine bedeutende Einsparung an Energie und Ressourcen mit sich bringt.
Zur Erinnerung an die Verpflichtung, die diese Geräte getrennt zu beseitigen, ist das Produkt mit einer durchgestrichen Mülltonne gekennzeichnet.

E ADVERTENCIA PARA LA ELIMINACIÓN CORRECTA DEL PRODUCTO SEGÚN ESTABLECE LA DIRECTIVA EUROPEA 2002/96/CE

Al final de su vida útil, este equipo no debe eliminarse junto a los desechos domésticos.
Debe entregarse a centros específicos de recogida diferenciada locales o a distribuidores que facilitan este servicio.
Eliminar por separado un equipo eléctrico y electrónico significa evitar posibles consecuencias negativas para el medio ambiente y la salud derivadas de una eliminación inadecuada y permite reciclar los materiales que lo componen, obteniendo así un ahorro importante de energía y recursos.
Para subrayar la obligación de eliminar por separado estos equipos, en el producto aparece un contenedor de basura tachado.

P ADVERTÊNCIA PARA A ELIMINAÇÃO CORRECTA DO PRODUTO NOS TERMOS DA DIRECTIVA EUROPÉIA 2002/96/CE

No fim da sua vida útil, este equipamento não deve ser eliminado juntamente com o lixo doméstico.
Deve ser depositado nos centros especializados de recolha diferenciada locais ou nos revendedores que forneçam este serviço.
Eliminar separadamente um equipamento eléctrico e electrónico permite evitar possíveis conseqüências negativas para o ambiente e para a saúde pública resultantes de uma eliminação inadequada, além de que permite recuperar e reciclar os materiais constituintes para, assim, obter uma importante poupança de energia e de recursos.
Para assinalar a obrigação de eliminar estes equipamentos separadamente, o produto apresenta a marca de um bidão do lixo com uma cruz por cima.

GR Προειδοποιήσεις για τη σωστή διάθεση του προϊόντος σύμφωνα με την Ευρωπαϊκή Οδηγία 2002/96/ΕΚ

Στο τέλος της ωφέλιμης ζωής του, το προϊόν δεν πρέπει να διατίθεται με τα αστικά απορρίμματα.
Μπορεί να διατεθεί σε ειδικά κέντρα διαφοροποιημένης συλλογής που ορίζουν οι δημοτικές αρχές, ή στις αντιρροσωπίες που παρέχουν αυτήν υπηρεσία. Η διαφοροποιημένη διάθεση μιας ηλεκτρικής συσκευής επιτρέπει την αποφυγή πιθανών αρνητικών συνεπειών για το περιβάλλον και την υγεία από την ακατάλληλη διάθεση καθώς και την ανακύκλωση υλικών από τα οποία αποτελείται ώστε να επιτυγχάνεται σημαντική εξοικονόμηση ενέργειας και πόρων. Για την επισήμανση της υποχρεωτικής χωριστής διάθεσης, το προϊόν φέρει το σήμα του διαγραμμένου τροχοφόρου κάδου απορριμμάτων.

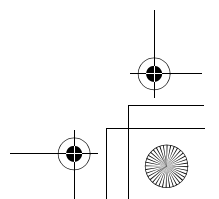
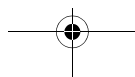
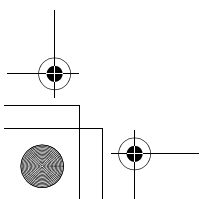

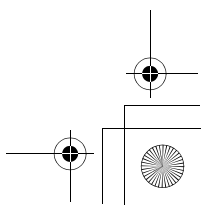
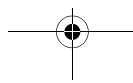
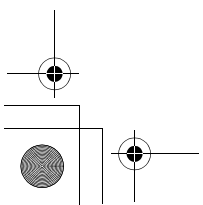
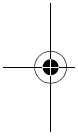
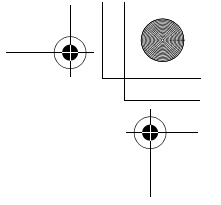
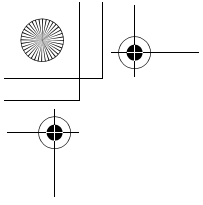

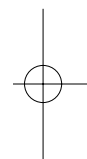
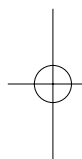
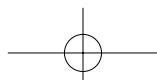
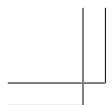

R.D. 28 Reyrieux BP 131 - 01601 Trévoux CEDEX France
Tel. (33) 04.74.00.92.92 - Fax (33) 04.74.00.42.00
<http://www.technibel.com>

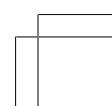
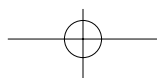
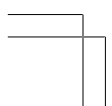

F-GAS REGULATION (EC) No 842/2006

- EG** Do not vent R410A into atmosphere: R410A is a fluorinated greenhouse gas, covered by Kyoto Protocol, with a Global Warming Potential (GWP) = 1975.
- ES** No expulsar R410A a la atmósfera: el R410A es un gas fluorado de efecto invernadero, cubierto por el protocolo de Kyoto, con potencial de calentamiento global (GWP) = 1975.
- F** Ne déchargez pas R410A dans l'atmosphère : R410A est un gaz fluoré à effet serre, couvert par le protocole de Kyoto, avec un potentiel de chauffage global (GWP) = 1975.
- D** Zerstreuen Sie R410A in Atmosphäre nicht: R410A ist ein fluoriertes Gas, abgedeckt durch Kyoto Protokoll, mit einem globalen wärmenden Potential (GWP) = 1975.
- I** Non disperdere R410A nell'atmosfera: R410A è un gas fluorinato a effetto serra, coperto dal protocollo di Kyoto, con potenziale di riscaldamento globale (GWP) = 1975.
- P** Não exale R410A na atmosfera: R410A é um fluorinated gás, coberto pelo protocolo de Kyoto, com um global Potencial Aquecendo-se (GWP) = 1975.
- GR** Μην αερίστε R410A στην ατμόσφαιρα: R410A είναι ένα φθοριωμένο θερμοκήπιο αέριο, που καλύπτεται από το πρωτόκολλο του Κιότο, με έναν σφαιρικό Δυνατότητα θέρμανσης (GWP) = 1975.