

INSTALLATION INSTRUCTIONS

– Multi Split system air conditioner –

For Indoor Unit

COOL / DRY / HEAT Model

This air conditioner uses the new refrigerant R410A.

Contents

	Page
IMPORTANT! Please Read Before Starting	2
1. GENERAL	3
1-1. Tools Required for Installation (not supplied)	
1-2. Accessories Supplied with Unit	
1-3. Optional Copper Tubing Kit	
1-4. Type of Copper Tube and Insulation Material	
1-5. Additional Materials Required for Installation	
2. INSTALLATION SITE SELECTION	4
2-1. Indoor Unit	
2-2. Embedding the Tubing and Wiring	
3. HOW TO INSTALL THE INDOOR UNIT	6
3-1. Remove the Rear Panel from the Unit	
3-2. Make a Hole	
3-3. Install the Rear Panel on the Wall	
3-4. Remove the Grille to Install the Indoor Unit	
3-5. Shape the Indoor Side Tubing	
3-6. Wiring Instructions	
3-7. Wiring Instructions for Inter-unit Connections	
3-8. Mounting	
3-9. Drain Hose	
4. MULTIPLE SWITCH ON THE REMOTE CONTROL UNIT INDOOR UNIT TYPES (MCAF188R5I, MCAF248R5I)	15
5. HOW TO TEST RUN THE AIR CONDITIONER ...	16
6. REMOTE CONTROL UNIT INSTALLATION POSITION	17
6-1. Mounting on a Wall	
7. ADDRESS SWITCH	18
7-1. Address Setting of the Remote Control Unit	
8. CONNECTING A HOME AUTOMATION DEVICE	19
9. INSTALLATION CHECK SHEET	19

Model Combinations

Combine indoor and outdoor units only as listed below.

Indoor Unit	↔	Outdoor Unit
MCAF78MR5I	↔	GRF148MR5I
MCAF98MR5I	↔	GRF198MR5I
MCAF128MR5I	↔	GRF248MR5I
MCAF188R5I	↔	GRF318MR5I
MCAF248R5I	↔	

Power Source:
50 Hz, single-phase, 220 – 240 VAC

Combinations of indoor and outdoor units
Connect indoor and outdoor units only in the combinations listed in the catalog or installation manual.



CAUTION

Connecting any other model may result in operation failure and system damage.

Be sure to read the yellow instruction sheet attached to the outdoor unit for models using the new refrigerant R410A.

NOTE

The illustrations are based on the typical appearance of a standard model. Consequently, the shape may differ from that of the air conditioner that you are installing.

English

Français

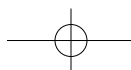

IMPORTANT! Please Read Before Starting

This air conditioning system meets strict safety and operating standards. As the installer or service person, it is an important part of your job to install or service the system so it operates safely and efficiently.

For safe installation and trouble-free operation, you must:

- Carefully read this instruction booklet before beginning.
- Follow each installation or repair step exactly as shown.
- Observe all local, state, and national electrical codes.
- Pay close attention to all warning and caution notices given in this manual.



WARNING

This symbol refers to a hazard or unsafe practice which can result in severe personal injury or death.



CAUTION

This symbol refers to a hazard or unsafe practice which can result in personal injury or product or property damage.

If Necessary, Get Help

These instructions are all you need for most installation sites and maintenance conditions. If you require help for a special problem, contact our sales/service outlet or your certified dealer for additional instructions.

In Case of Improper Installation

The manufacturer shall in no way be responsible for improper installation or maintenance service, including failure to follow the instructions in this document.

SPECIAL PRECAUTIONS

WARNING When Wiring



ELECTRICAL SHOCK CAN CAUSE SEVERE PERSONAL INJURY OR DEATH. ONLY A QUALIFIED, EXPERIENCED ELECTRICIAN SHOULD ATTEMPT TO WIRE THIS SYSTEM.

- Do not supply power to the unit until all wiring and tubing are completed or reconnected and checked.
- Highly dangerous electrical voltages are used in this system. Carefully refer to the wiring diagram and these instructions when wiring. Improper connections and inadequate grounding can cause **accidental injury or death**.
- **Ground the unit** following local electrical codes.
- Connect all wiring tightly. Loose wiring may cause overheating at connection points and a possible fire hazard.
- Install a protective **leakage breaker** depending on the installation location (especially a damp or humid location). If a **leakage breaker** is not installed, electric shock can occur.

When Transporting

Be careful when picking up and moving the indoor and outdoor units. Get a partner to help, and bend your knees when lifting to reduce strain on your back. Sharp edges or thin aluminum fins on the air conditioner can cut your fingers.

When Installing...

...In a Ceiling or Wall

Make sure the ceiling/wall is strong enough to hold the unit's weight. It may be necessary to construct a strong wood or metal frame to provide added support.

...In a Room

Properly insulate any tubing run inside a room to prevent "sweating" that can cause dripping and water damage to walls and floors.

...In Moist or Uneven Locations

Use a raised concrete pad or concrete blocks to provide a solid, level foundation for the outdoor unit. This prevents water damage and abnormal vibration.

When Connecting Refrigerant Tubing

- Do not add any refrigerant, air, or substance into the refrigeration circuit other than the designated refrigerant (R410A). Adding anything other than the specified refrigerant may cause the pressure to rise excessively in the refrigeration circuit, rupturing the circuit and causing injury or damage.
- Use all-new tubing and flare nuts to make the tubing connections. Using any previous parts (from R22-based systems) may result in damage to the equipment, and may lead to the refrigeration circuit rupturing, causing a serious accident.
- Apply refrigerant lubricant to the matching surfaces of the flare and union tubes before connecting them, then tighten the nut with a torque wrench for a leak-free connection.
- Check carefully for leaks before starting the test run.

When Servicing

- Turn the power OFF at the main power box (mains) before opening the unit to check or repair electrical parts and wiring.
- Keep your fingers and clothing away from any moving parts.
- Clean up the site after you finish, remembering to check that no metal scraps or bits of wiring have been left inside the unit being serviced.



CAUTION

Others

- Ventilate any enclosed areas when installing or testing the refrigeration system. Escaped refrigerant gas, on contact with fire or heat, can produce dangerously toxic gas.
- Confirm upon completing installation that no refrigerant gas is leaking. If escaped gas comes in contact with a stove, gas water heater, electric room heater or other heat source, it can produce dangerously toxic gas.

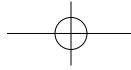

1. General







This booklet briefly outlines where and how to install the air conditioning system. Please read over the entire set of instructions for the indoor and outdoor units and make sure all accessory parts listed are with the system before beginning.

1-1. Tools Required for Installation (not supplied)

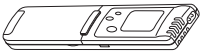
1. Standard screwdriver
2. Phillips head screwdriver
3. Knife or wire stripper
4. Tape measure
5. Carpenter's level
6. Sabre saw or key hole saw
7. Hacksaw
8. Core bits
9. Hammer
10. Drill
11. Tube cutter
12. Tube flaring tool
13. Torque wrench
14. Adjustable wrench
15. Reamer (for deburring)

1-2. Accessories Supplied with Unit

Table 1

Parts	Figure	Q'ty	Parts	Figure	Q'ty	Parts	Figure	Q'ty
Remote control unit		1	Tapping screw	Truss-head Phillips 4 × 16 mm 	2	Air clean filter		2
Remote control unit holder		1	Tapping screw	Truss-head Phillips 4 × 30 mm 	8	Clamp		1
AAA alkaline battery		2	Packed in the indoor unit.					

1-3. Optional Copper Tubing Kit

Copper tubing for connecting the outdoor unit to the indoor unit is available in kits which contain the narrow and wide tubing, fittings and insulation. Consult your nearest sales outlet or Air Conditioner workshop.

2. Foamed polyethylene insulation for the specified copper tubes as required to precise length of tubing. Wall thickness of the insulation should be not less than 8 mm.
3. Use insulated copper wire for field wiring. Wire size varies with the total length of wiring. Refer to 3-6. Wiring Instructions for details.

1-4. Type of Copper Tube and Insulation Material

If you wish to purchase these materials separately from a local source, you will need:

1. Deoxidized annealed copper tube for refrigerant tubing as detailed in Table 2.
Cut each tube to the appropriate lengths +30 cm to 40 cm to dampen vibration between units.



CAUTION

Check local electrical codes and regulations before obtaining wire. Also, check any specified instructions or limitations.

Table 2

Model	Narrow Tube		Wide Tube	
	Outer Dia.	Thickness	Outer Dia.	Thickness
MCAF78	6.35 mm	0.8 mm	9.52 mm	0.8 mm
MCAF98	6.35 mm	0.8 mm	9.52 mm	0.8 mm
MCAF128	6.35 mm	0.8 mm	9.52 mm	0.8 mm
MCAF188	6.35 mm	0.8 mm	12.70 mm	0.8 mm
MCAF248	6.35 mm	0.8 mm	15.88 mm	1.0 mm

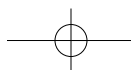

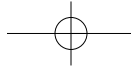

English

1-5. Additional Materials Required for Installation

1. Refrigeration (armored) tape
2. Insulated staples or clamps for connecting wire
(See local codes)
3. Putty
4. Refrigeration lubricant
5. Clamps or saddles to secure refrigerant tubing

2. Installation Site Selection

2-1. Indoor Unit



WARNING

To prevent abnormal heat generation and the possibility of fire, do not place obstacles, enclosures and grilles in front of or surrounding the air conditioner in a way that may block air flow.

AVOID:

- direct sunlight.
- nearby heat sources that may affect performance of the unit.
- areas where leakage of flammable gas may be expected.
- placing or allowing any obstructions near the Air Conditioner inlet or outlet.
- installing in rooms that contain instant-on (rapid-start) fluorescent lamps. (These may prevent the Air Conditioner from receiving signals.)
- places where large amounts of oil mist exist.
- installing in locations where there are devices that generate high-frequency emissions.

DO:

- select an appropriate position from which every corner of the room can be uniformly cooled. (High on a wall is best.)
- select a location that will hold the weight of the unit.
- select a location where tubing and drain hose have the shortest run to the outside. (Fig. 1)
- allow room for operation and maintenance as well as unrestricted air flow around the unit. (Fig. 2)
- install the unit within the maximum elevation difference (H1, H2, H3, H4) above or below the outdoor unit and within a total tubing length (L1+L2, L1+L2+L3, L1+L2+L3+L4) from the outdoor unit as detailed in Table 3 and Fig. 3a.

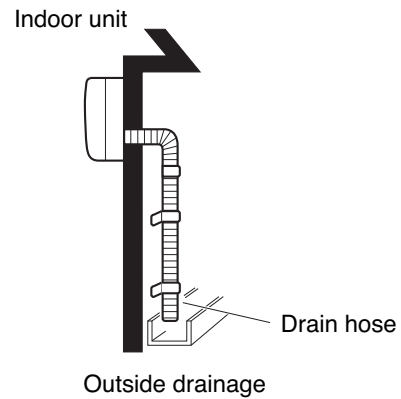
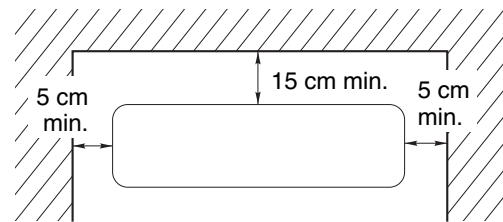

Fig. 1



Front View

Fig. 2

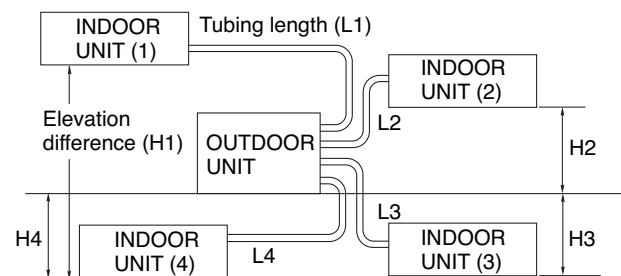

Fig. 3a



CAUTION

For stable operation of the air conditioner, do not install wall-mounted type indoor units less than 1.5 m from floor level.

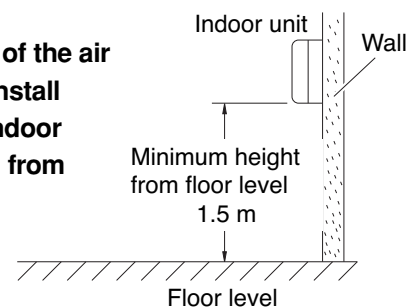
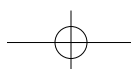
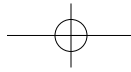

Fig. 3b





- Install the indoor unit more than 1 meter away from any antenna or power lines or connecting wires used for television, radio, telephone, security system, or intercom. Electrical noise from any of these sources may affect operation.
- install in a sturdy manner to avoid increased operating noise.

Table 3

Model	Max. Allowable Tubing Length per unit (m)	Max. Allowable Total Tubing Length at shipment (L1+L2) or (L1+L2+L3) or (L1+L2+L3+L4) (m)	Limit of Total Tubing Length (L1+L2) or (L1+L2+L3) or (L1+L2+L3+L4) (m)	Limit of Elevation Difference (H1, H2, H3, H4) (m)	Required Amount of Additional Refrigerant (g/m)*
GRF148	20	30 (L1+L2)	30 (L1+L2)	15	–
GRF198	25	45 (L1+L2)	45 (L1+L2)	15	–
GRF248	25	45 (L1+L2+L3+L4)	60 (L1+L2+L3+L4)	15	20
GRF318	30	45 (L1+L2+L3+L4)	70 (L1+L2+L3+L4)	15	20

* If total tubing length becomes 45 to 60 m (max.) or 45 to 70 m (max.), charge additional refrigerant (R410A) by 20 g/m. No additional charge of compressor oil is necessary.

English

2-2. Embedding the Tubing and Wiring

- Before beginning embedding installation work, consult fully with agencies or offices related to the building's foundation, construction, electricity, and water.
- Wait to make connections to the embedded portion. Each connection step is described later in this manual.
- Securely cover the end of the embedded tubing to prevent intrusion of dirt or moisture.
- If an embedded tube is to be left for a long time, fill the tube with nitrogen and seal both ends securely. If a tube is left open for an extended time, moisture in the air inside the tubing may condense into water droplets, and lead to water contamination of the refrigerant circuit.
- In order to prevent insulation breakdown and ground faults, do not allow wiring ends to come in contact with rainwater, or be subjected to condensation or dew.
- Apply sufficient thermal insulation to the refrigerant tubing and drain pipes

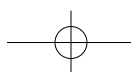

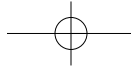

3. How to Install the Indoor Unit

3-1. Remove the Rear Panel from the Unit

- (1) Remove and discard the set screw on the rear panel. (Fig. 6)
- (2) Press the 2 Δ marks on the frame cover and disengage the stationary tabs from the frame. (Fig. 7)
- (3) Remove the rear panel.

English

NOTE

Tubing can be extended in 5 directions as shown in Fig. 8. Select the direction you need providing the shortest run to the outside unit.

- When left tubing is to be done, switch the drain hose and drain cap. (For details, refer to “Switching drain hose and drain cap” on page 14.)

3-2. Make a Hole

- (1) Place the rear panel from the indoor unit on the wall at the location selected. Make sure the panel is horizontal, using a carpenter’s level or tape measure to measure down from the ceiling. Wait until after cutting the hole before attaching the rear panel to the wall.

- (2) Determine which side of the unit you should make the hole for tubing and wiring. (Fig. 9a or 9b)

NOTE

In the case of left-rear tubing, use the measurement points from the edge of the rear panel for precise placement of the hose outlet. (Fig. 9a or 9b)

- (3) Before making the hole, check carefully that no studs or pipes are directly run behind the spot to be cut.



CAUTION

Also avoid areas where electrical wiring or conduits are located.

The above precautions are also applicable if tubing goes through the wall in any other location.

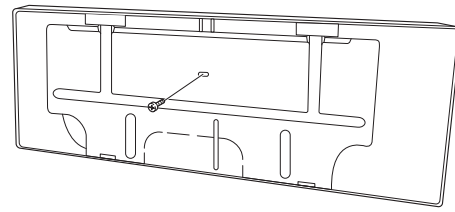

Set screw only for transportation

Fig. 6

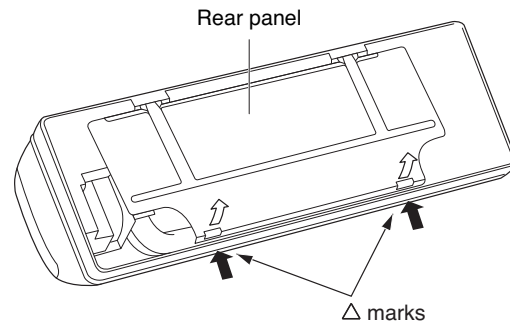

Fig. 7

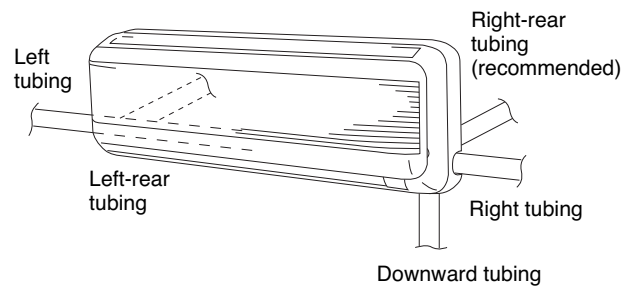

Fig. 8

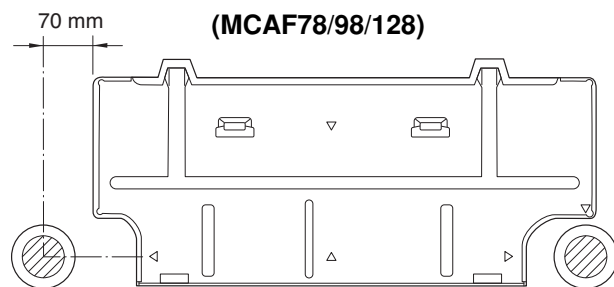

Fig. 9a

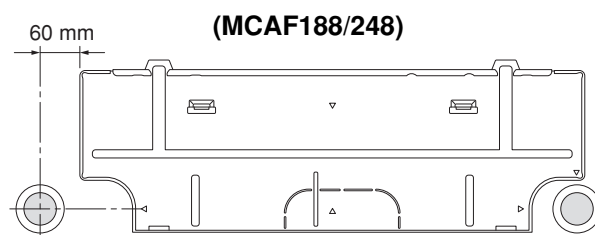
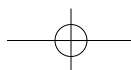
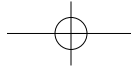

Fig. 9b





- (4) Using a sabre saw, key hole saw or hole-cutting drill attachment, cut a hole in the wall. See Table 4 and Fig. 10.

Table 4

Hole Dia. (mm)	
MCAF78/98/128	MCAF188/248
65	80

- (5) Measure the thickness of the wall from the inside edge to the outside edge and cut PVC pipe at a slight angle 6 mm shorter than the thickness of the wall. (Fig. 11)
- (6) Place the plastic cover over the end of the pipe (for indoor side only) and insert the pipe in the wall. (Fig. 12)

3-3. Install the Rear Panel on the Wall

Be sure to confirm that the wall is strong enough to suspend the unit.

See either Item a) or b) below depending on the wall type.

a) If Wooden Wall

- (1) Attach the rear panel to the wall with the 8 screws provided. (Fig. 13a or 13b)

If you are not able to line up the holes in the rear panel with the beam locations marked on the wall, use rawl plugs or toggle bolts to go through the holes on the panel or drill 5 mm dia. holes in the panel over the stud locations and then mount the rear panel.

- (2) Double check with a carpenter's level or tape measure that the panel is level. This is important to install the unit properly. (Fig. 14)
- (3) Make sure the panel is flush against the wall. Any space between the wall and unit will cause noise and vibration.

b) If Block, Brick, Concrete or Similar Type Wall

Make 4.8 mm dia. holes in the wall. Insert rawl plugs for appropriate mounting screws. (Fig. 15)

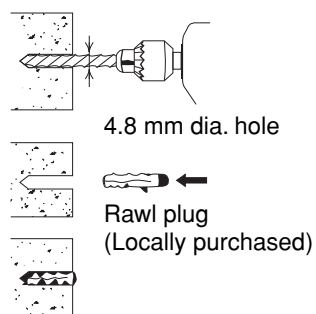

Fig. 15

NOTE

Hole should be made at a slight downward slant to the outdoor side.

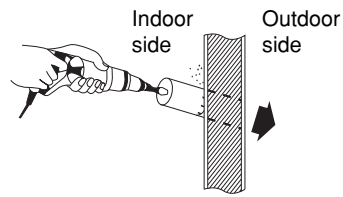

Fig. 10

PVC pipe (Locally purchased)

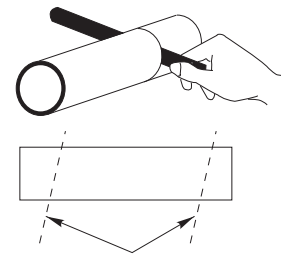

Fig. 11

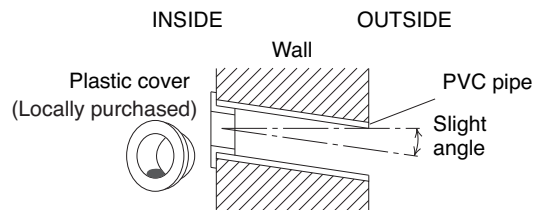

Fig. 12

(MCAF78/98/128)

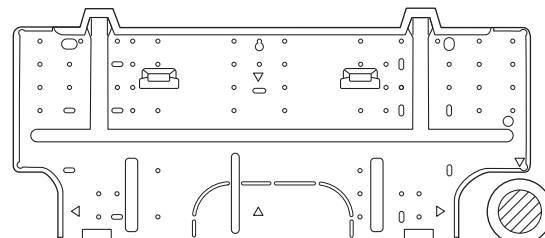

Fig. 13a

(MCAF188/248)

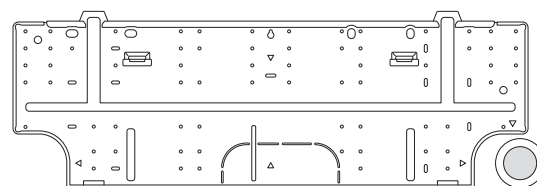

Fig. 13b

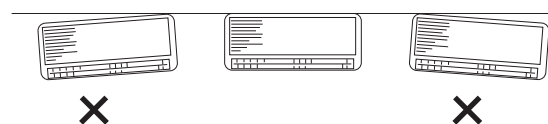
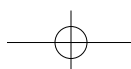
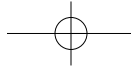

Fig. 14

English





3-4. Remove the Grille to Install the Indoor Unit

3-4-1. Indoor unit types (MCAF78/98/128)

Basically, these models can be installed and wired without removing the grille. If access to any internal part is needed, follow the steps as given below.

English



CAUTION

Be sure to wear work gloves during installation to avoid being cut by the sharp aluminum fins of the heat exchanger.

How to remove the grille

- (1) Grasp both ends of the air intake grille, and remove it by opening towards the front and pulling towards you. (Fig. 16a)
- (2) Remove the 2 screws. (Fig. 16b)
- (3) Remove the screw on the right side cover plate and open the cover. (Fig. 17a)
- (4) Take out the thermistor from the grille. (Fig. 17b)
- (5) Pull the lower part of the grille towards you to remove. (Fig. 18a)
- (6) Use a standard screwdriver to push on the tabs to remove the grille.

How to replace the grille

- (1) Reinstall the grille into the lower part while aligning its tabs on the upper part. (Fig. 18b) Insert the tabs in the slots and push the lower part of the grille back into position.
- (2) Make sure that the grille and frame are firmly fitted together by engaging the tabs.
- (3) Attach the thermistor on the grille. (Fig. 17a)
- (4) Close the cover and replace the screw. (Fig. 17a)
- (5) Affix the grille with the 2 previously removed screws. (Fig. 16b)
- (6) Install the air intake grille.
 - (a) Allow the edge of the air intake grille to slide into the top of the indoor unit, and then insert it all the way inside. (Fig. 19a)
 - (b) Press the bottom right and left corners of the air intake grille to attach it to the indoor unit. (Fig. 19b)

NOTE

Attach so that the round pins at the top right and left corners of the air intake grille are inserted into the grooves at the top right and left of the indoor unit.

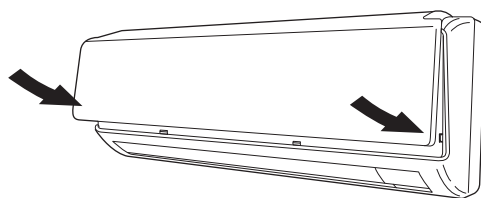

Fig. 19b

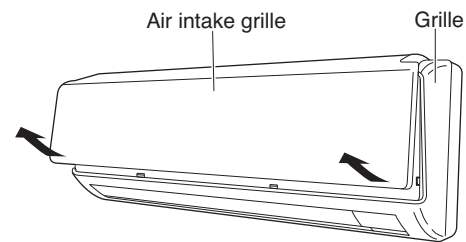

Fig. 16a

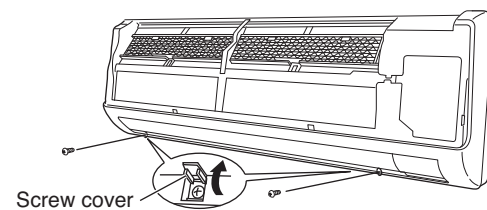

Fig. 16b

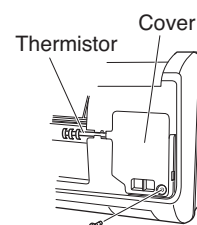

Fig. 17a

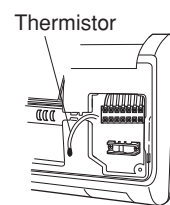

Fig. 17b

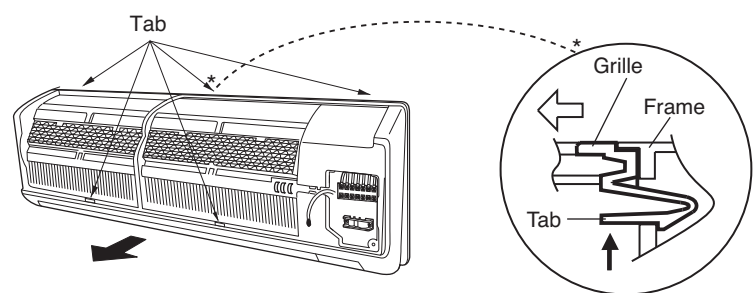

Fig. 18a

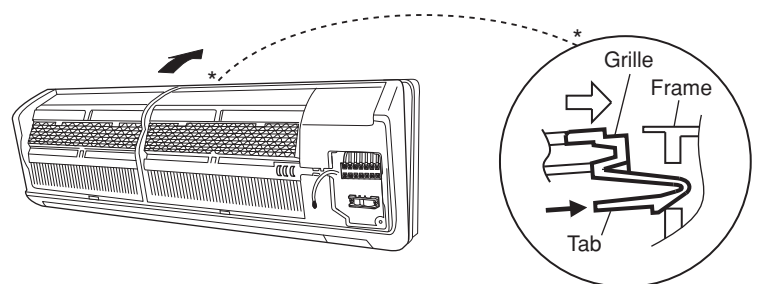
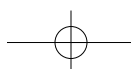
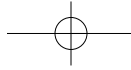

Fig. 18b



Fig. 19a





3-4-2. Indoor unit types (MCAF188/248)

Basically, these models can be installed and wired without removing the grille. If access to any internal part is needed, follow the steps as given below.

How to remove the grille

- (1) Grasp both ends of the air intake grille, and remove it by opening towards the front and pulling towards you. (Fig. 16a-1)
- (2) Remove the 3 screws. (Fig. 16b-1)
- (3) Remove the screw on the right side cover plate and open the cover. (Fig. 17a-1)
- (4) Take out the thermistor from the grille. (Fig. 17b-1)
- (5) Press the 3 tabs at the top of the grille and the 3 tabs on the front face to separate the grille from the frame. (Fig. 18a-1)
- (6) Pull the grill towards you to remove it.

How to replace the grille

- (1) When installing the grille, place the bottom of the grille into the frame first. (Fig. 18b-1)
Then insert the tabs on the top of the grille and on the front face into the frame.
- (2) Make sure that the grille and frame are firmly fitted together by engaging the tabs.
- (3) Attach the thermistor on the grille. (Fig. 17a-1)
- (4) Close the cover and replace the screw. (Fig. 17a-1)
- (5) Affix the grille with the 3 previously removed screws. (Fig. 16b-1)
- (6) Install the air intake grille.
 - (a) Allow the edge of the air intake grille to slide into the top of the indoor unit, and then insert it all the way inside. (Fig. 19a-1)
 - (b) Press the bottom right and left corners and center of the air intake grille to attach it to the indoor unit. (Fig. 19b-1)

NOTE

Attach so that the round pins at the top right and left corners of the air intake grille are inserted into the grooves at the top right and left of the indoor unit.

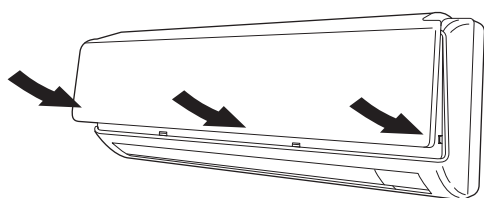

Fig. 19b-1

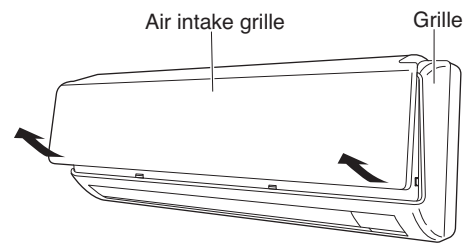

Fig. 16a-1

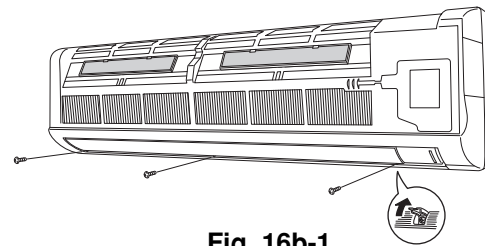

Fig. 16b-1

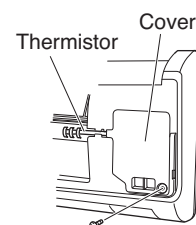

Fig. 17a-1

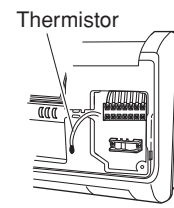

Fig. 17b-1

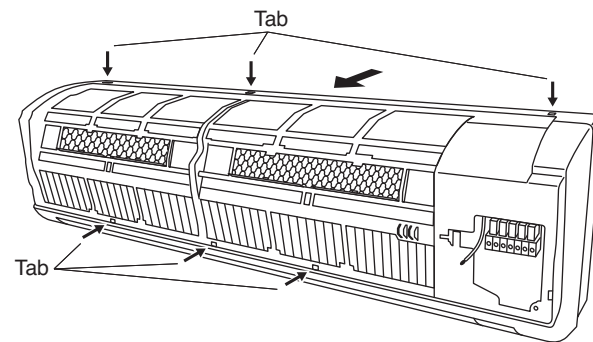

Fig. 18a-1

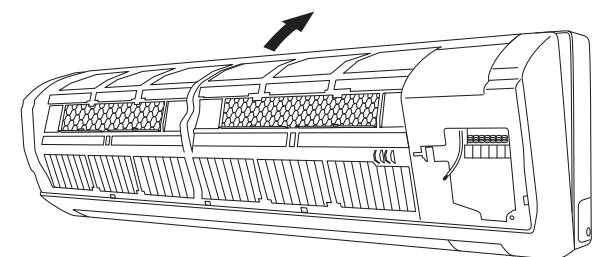

Fig. 18b-1

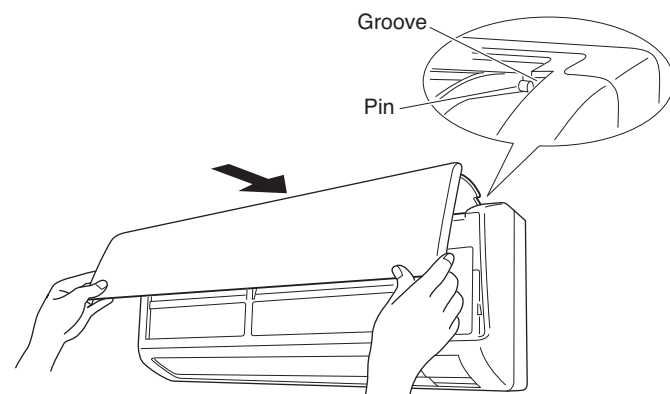
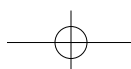
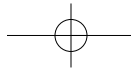

Fig. 19a-1





3-5. Shape the Indoor Side Tubing

(1) Arrangement of tubing by directions

a) Right or left tubing

Cut out the corner of the right/left frame with a hacksaw or the like. (Figs. 20 and 21)

b) Right-rear or left-rear tubing

In this case, the corner of the frame need not be cut.

(2) To mount the indoor unit on the rear panel:

Hang the 2 mounting slots of the unit on the upper tabs of the rear panel. (Fig. 22)

3-6. Wiring Instructions

General precautions on wiring

- (1) Before wiring, confirm the rated voltage of the unit as shown on its nameplate, then carry out the wiring closely following the wiring diagram.
- (2) Provide a power outlet to be used exclusively for each unit, with a power supply disconnect and circuit breaker for overcurrent protection provided in the exclusive line.
- (3) To prevent possible hazard due to insulation failure, the unit must be grounded.
- (4) Each wiring connection must be done tightly and in accordance with the wiring system diagram. Wrong wiring may cause the unit to misoperate or become damaged.
- (5) Do not allow wiring to touch the refrigerant tubing, compressor, or any moving parts of the fan.
- (6) Unauthorized changes in the internal wiring can be very dangerous. The manufacturer will accept no responsibility for any damage or misoperation that occurs as a result of such unauthorized changes.

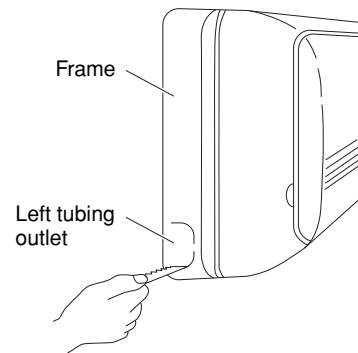

Fig. 20

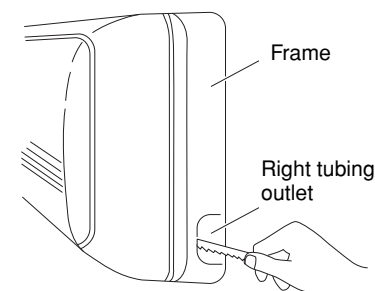

Fig. 21

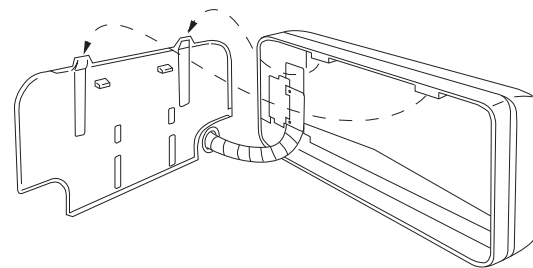
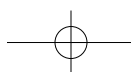
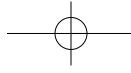

Fig. 22





3-7. Wiring Instructions for Inter-unit Connections

- (1) Grasp both ends of the air intake grille, and remove it by opening towards the front and pulling towards you.
- (2) Remove the screw on the right side cover plate and open the cover. (Fig. 24)
- (3) Insert the inter-unit wiring into the through-the-wall PVC pipe. Lead the power wiring into the room allowing approx. 25 cm to extend from the wall face. (Fig. 25)
- (4) Route the inter-unit wiring from the back of the indoor unit and pull it towards the front for connection. (Fig. 26)
- (5) Connect the inter unit wiring to the corresponding terminals on the terminal plate (Fig. 26) while referring to the wiring diagram.
- (6) Be sure to secure the wiring with the provided clamp.

NOTE

When closing the air intake grille, press the bottom right and left corners and center. (Fig. 27)

Please refer to "How to replace the grille" on page 8 or 9 for installing the air intake grille.

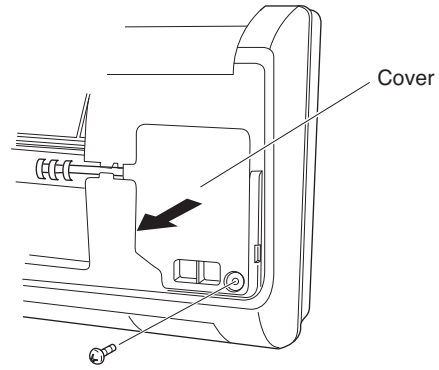

Fig. 24

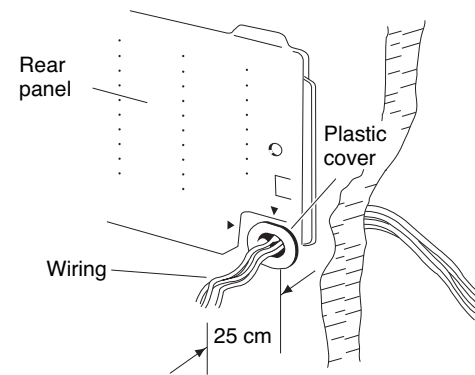

Fig. 25

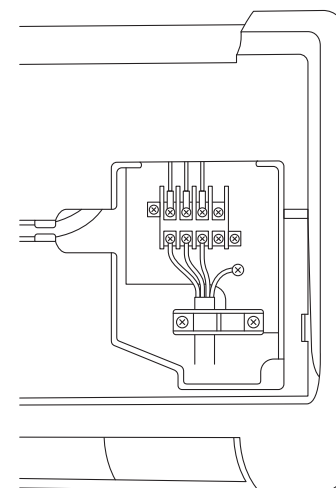

Fig. 26

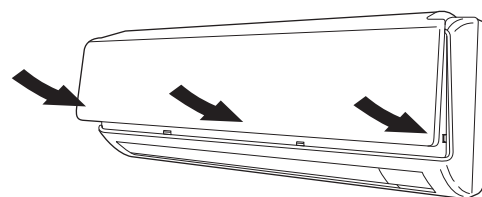
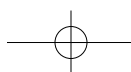

Fig. 27



**WARNING**

Loose wiring may cause the terminal to overheat or result in unit malfunction. A fire hazard may also exist. Therefore, be sure all wiring is tightly connected.

English

When connecting each power wire to the corresponding terminal, follow the instructions "How to connect wiring to the terminal" and fasten the wire securely tight with the fixing screw of the terminal plate.

How to connect wiring to the terminal**a) For Indoor Unit**

- (1) Cut the wire end with a cutting pliers, then strip the insulation to expose the wire about 7 mm. See the label (Fig. 28) near the terminal plate.
- (2) Using a screwdriver, loosen the terminal screw on the terminal plate.
- (3) Insert the wire and tighten the terminal screw completely using a screwdriver.

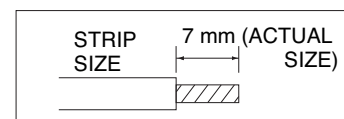
**Fig. 28****b) For Outdoor Unit****■ For solid core wiring (or F-cable)**

- (1) Cut the wire end with a cutting pliers, then strip the insulation to expose the solid wire about 25 mm. (Fig. 29)
- (2) Using a screwdriver, remove the terminal screw(s) on the terminal plate.
- (3) Using the pliers, bend the solid wire to form a loop suitable for the terminal screw.
- (4) Shape the loop wire properly, place it on the terminal plate and fix it securely with the removed terminal screw using a screwdriver.

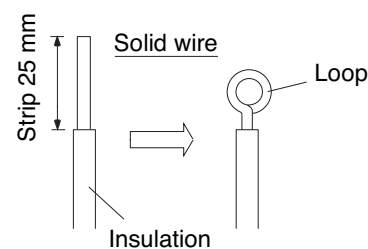
**Fig. 29****■ For stranded wiring**

- (1) Cut the wire end with a cutting pliers, then strip the insulation to expose the stranded wiring about 10 mm and tightly twist the wire ends. (Figs. 30 and 31)
- (2) Using a screwdriver, remove the terminal screw(s) on the terminal plate.
- (3) Using a ring connector fastener or pliers, securely clamp each stripped wire end with a ring connector. (Fig. 30)
- (4) Place the ring connector wire, and replace and tighten the removed terminal screw using a screwdriver. (Fig. 32)

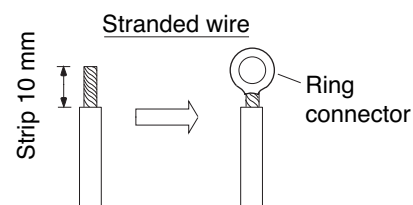
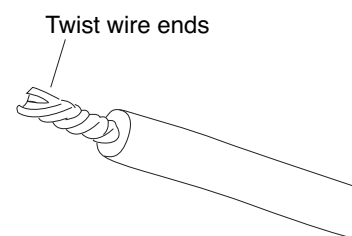
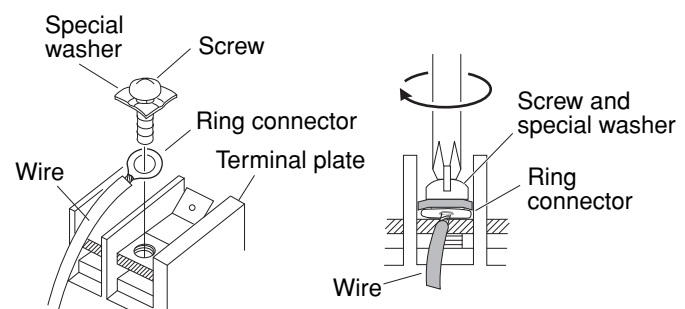
**Fig. 30****Fig. 31****Fig. 32**

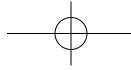

3-8. Mounting

- (1) To install the indoor unit, mount the indoor unit onto the 2 tabs on the upper part of the rear plate.
- (2) Hold down the air discharge outlet and press the lower part of the indoor unit until it clicks to securely fasten to the 2 tabs on the lower part of the rear plate. (Fig. 33)

NOTE

For tubing, choose either the right or left tubing direction and follow the steps below. This work can be made easier by placing padding material (such as styrofoam) at the rear right side of the indoor unit. (Fig. 34)

■ Right-side tubing

- (1) Shape the refrigerant tubing so that it can easily go into the wall hole. (Fig. 35)
- (2) Push the wiring, refrigerant tubing, and drain hose through the hole in the wall. Adjust the indoor unit so it is securely seated on the rear panel. (Fig. 36)
- (3) Carefully bend the tubing (if necessary) to run along the wall in the direction of the outdoor unit and then tape as far as the fittings. (See Caution on page 15 in the outdoor unit installation manual.) The drain hose should come straight down the wall to a point where water runoff won't stain the wall.
- (4) Connect the refrigerant tubing to the outdoor unit. (After performing a leak test on the connecting part, insulate it with the tubing insulation. (Fig. 37)) Also, refer to Section 3-6. Tubing connections in the outdoor unit installation manual.
- (5) Assemble the refrigerant tubing, drain hose, and inter-unit wiring as shown in Fig. 37.

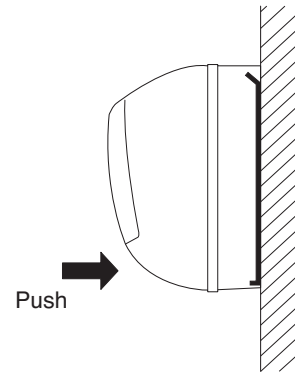

Fig. 33

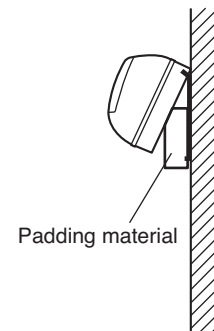

Fig. 34

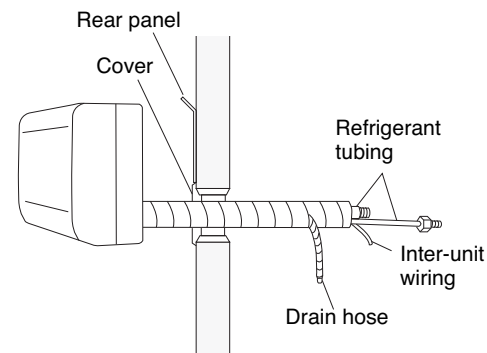

Fig. 35

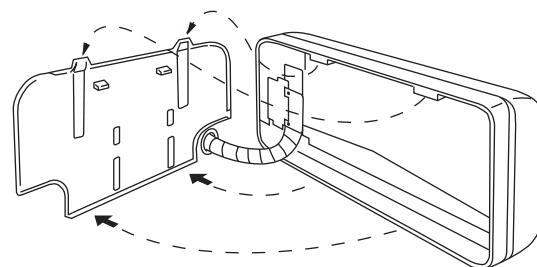

Fig. 36

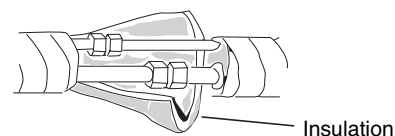
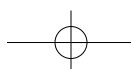

Fig. 37



■ Left-side tubing

- (1) Lead the tubing and drain hose through the wall, allowing sufficient length for connection. Then bend the tubing using a tube bender to make the attachment. (Fig. 38)

- (2) Switch the drain hose and drain cap.

Switching drain hose and drain cap

- (a) Locate the drain hose and the drain cap. (Fig. 39)
- (b) Remove the screws fastening the drain hose on the right side, and pull out the drain hose to remove it. (Fig. 39)
- (c) Apply moderate force to pull off the drain cap on the left side. (If you cannot pull it off by hand, use a long-nose pliers.)
- (d) Reattach the drain hose to the left side and the drain cap to the right side. (Fig. 40a)

Drain hose

Slide the drain hose fully onto the drain pan outlet until the drain hose edge is pushed into the insulation. Check that the screw holes in the drain bracket and the drain pan outlet are aligned and securely in contact, then fasten them with the screw. (After attaching the drain hose, check that it is attached securely.) (Figs. 40b and 40c)

Drain cap

Use a Phillips screwdriver to push the drain cap in firmly. (If it is difficult to push in, wet the cap with water first.)

- (3) Install the indoor unit on the rear panel.
- (4) Connect the tubing and wiring led inside from outdoors.
- (5) After completing a leak test, bundle the tubing together with armoring tape and store it inside the tubing storage area at the back of the indoor unit and hold it with clamps. (Fig. 41)

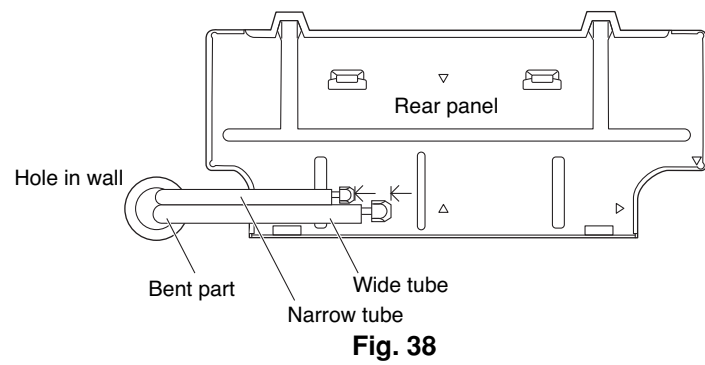

Fig. 38

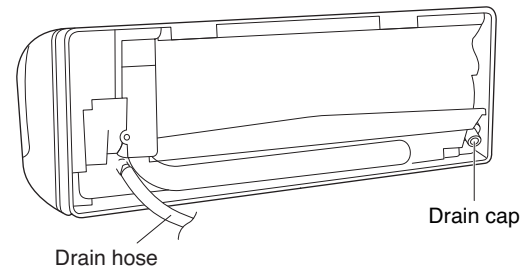

Fig. 39

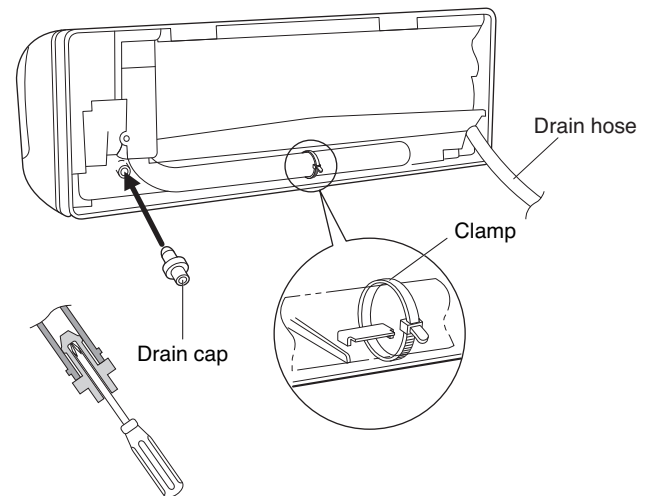

Fig. 40a

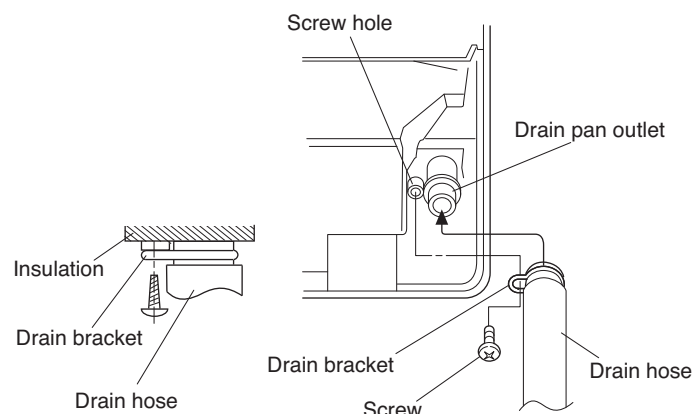

Fig. 40c

Fig. 40b

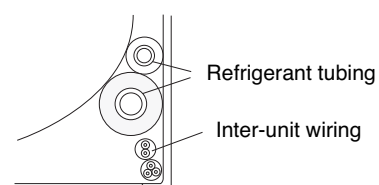
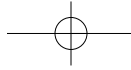

Fig. 41



To unmount indoor unit

Press the 2 △ marks on the lower part of the indoor unit and unlatch the tabs. Then lift the indoor unit and unmount. (Fig. 42)

3-9. Drain Hose

- a) The drain hose should be slanted downward to the outdoors. (Fig. 43)
- b) Never form a trap in the course of the hose.
- c) If the drain hose will run in the room, insulate the hose with insulation* so that chilled condensation will not damage furniture or floors. (Fig. 44)

* Foamed polyethylene or its equivalent is recommended.

WARNING Do not supply power to the unit or operate it until all tubing and wiring to the outside unit are completed.

Risk of Electric Shock

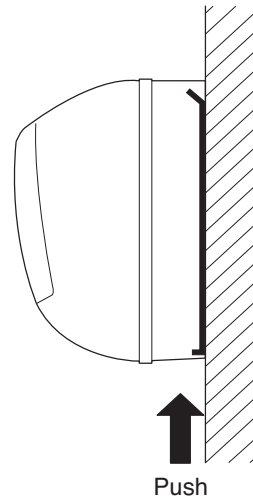

Fig. 42

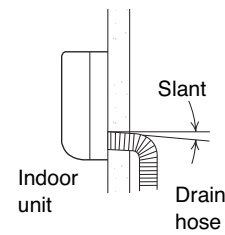

Fig. 43

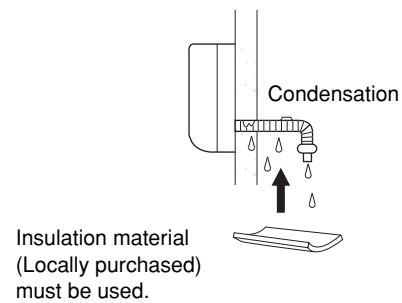
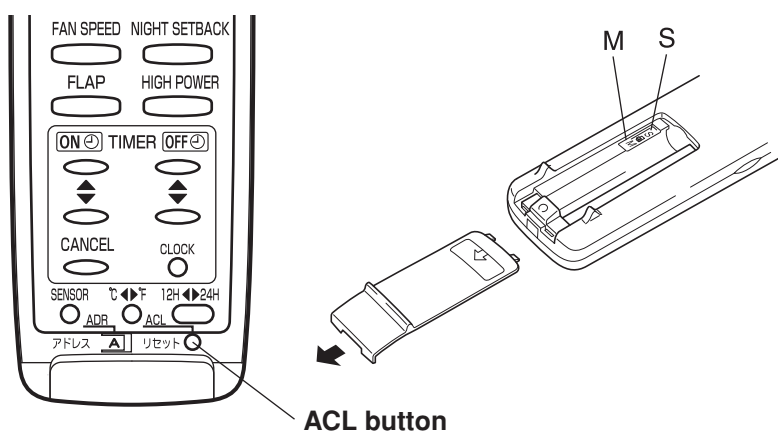

Fig. 44

4. Multiple Switch on the Remote Control Unit Indoor Unit Types (MCAF188R5I, MCAF248R5I)

S/M (Single/Multiple switch)

- Initially, the S/M switch is set to S (Single).
- Set this switch to M (Multiple) for multiple operation.
- Always press ACL button by a thin object such as the tip of a pen after setting the S/M switch.



- Slide the cover in the direction indicated by the arrow and remove it.
- Use a thin object such as the tip of a pen to press the ACL button.

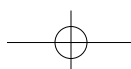

5. How to Test Run the Air Conditioner

After turning on power to the air conditioner, use the remote controller and follow the steps below to conduct the test run.

- (1) Set the remote controller in Test Run mode. (Fig. 59a)
 - a) Press and hold the ION button.
 - b) Then press and hold the 1HR. TIMER button.
 - c) At the same time, press the ACL (reset) button once. Use a pointed object such as the tip of a pen to press the ACL button.
 - After a few seconds, “❄” appears and “oP-1” blinks in the remote controller display area. (Fig. 59b)
 - d) Release the 1HR. TIMER button.
 - e) Release the ION button.
- (2) Start Cooling mode test run by pressing the ON/OFF operation button of the remote controller. (Fig. 59a)
 - This starts the fan producing uncooled forced air with the 4 indicator lamps (OPERATION lamp, TIMER lamp, QUIET lamp, and ION lamp) on the main unit blinking. (Fig. 60)
 - After 3 minutes, the system shifts into cooling operation, and cool air will start to be felt. Cool mode test run is unaffected by the room temperature.
- (3) Press the ON/OFF operation button of the remote controller again to stop the test run. (Fig. 59a)
- (4) Finally press the ACL (reset) button of the remote controller to release it from Test Run mode to return to normal mode. (Fig. 59a)
 - “❄” and “oP-1” will disappear from the remote controller display area.

IMPORTANT

After the test run is completed, be sure to press the ACL (reset) button to return to normal mode. The air conditioner will not operate correctly if this is not done.

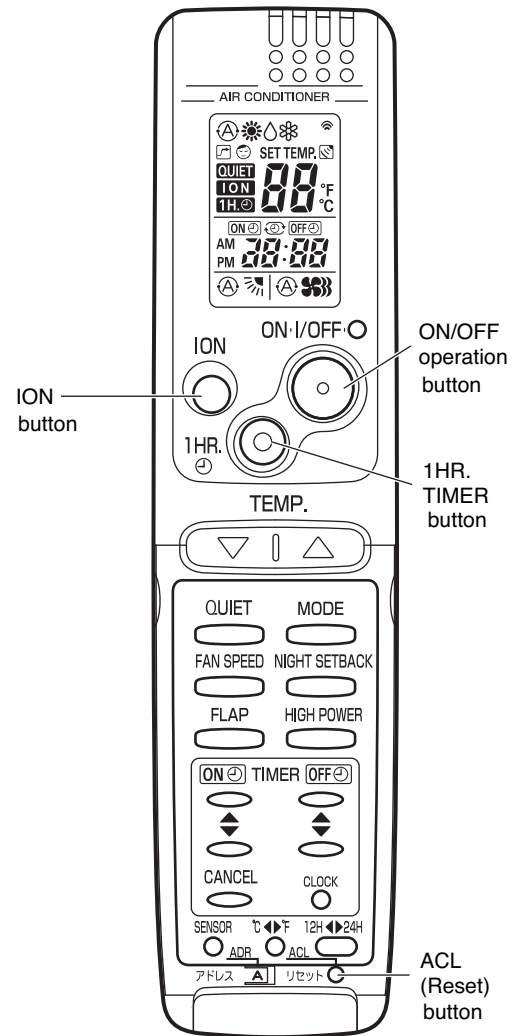

Fig. 59a

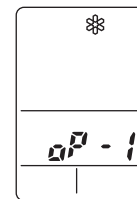

Fig. 59b

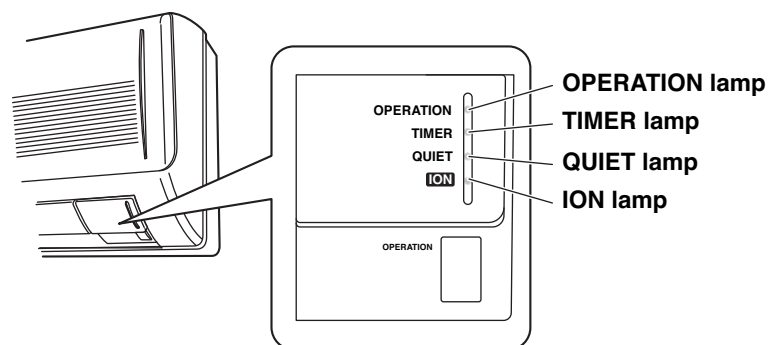
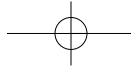

Fig. 60



6. Remote Control Unit Installation Position

The remote control unit can be operated from either a non-fixed position or a wall-mounted position.

To ensure that the air conditioner operates correctly, do not install the remote control unit in the following places:

- In direct sunlight
- Behind a curtain or other place where it is covered
- More than 8 m away from the air conditioner
- In the path of the air conditioner's airstream
- Where it may become extremely hot or cold
- Where it may be subject to electrical or magnetic interference
- Where there is an obstacle between the remote control unit and the air conditioner (since a check signal is sent from the remote control unit every 5 minutes)

6-1. Mounting on a Wall

Before mounting the remote control unit, press the ON/OFF operation button at the mounting location to make sure that the air conditioner operates from that location. The indoor unit should make a beeping sound to indicate that it has received the signal.

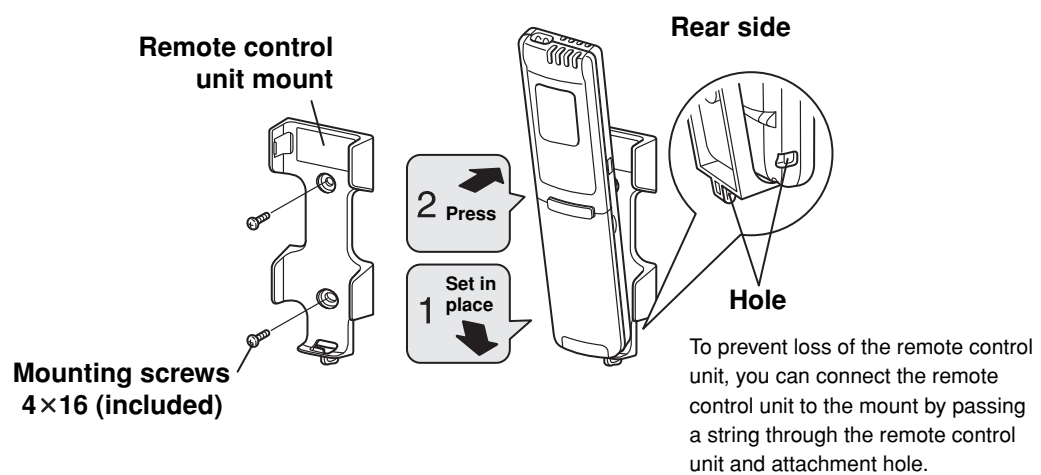

To take out the remote control unit, pull it forward.

Fig. 61

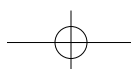

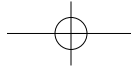

7. Address Switch

7-1. Address Setting of the Remote Control Unit

The address can be set in order to prevent interference between remote controllers when two indoor units are installed near each other. The address is normally set to "A." To set a different address, it is necessary to change the address on the second remote controller.

English

NOTE

Once changed, you cannot restore the original address setting of the air conditioner.

- (1) Switch on the power source.
- (2) Break the address-setting tab marked "A" on the second remote controller to change the address (Fig. 62). When the tab is removed, the address is automatically set to B (Fig. 63).
- (3) Press and hold the remote controller ION button and 1 HR. TIMER button. At the same time, press the ACL(reset) button. Use a thin object such as the tip of a pen to press the ACL button. When this has been done, "oP-1" (test run) appears, blinking, in the remote controller clock display area.
- (4) Each time the 1 HR. TIMER button is pressed, the display changes as shown below. Press this button 2 times to change the display to "oP-7" (address setting). (Fig. 64)

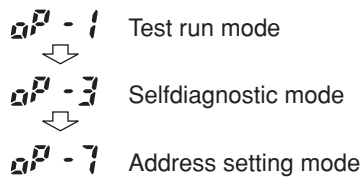

- (5) "oP-7" has now been selected for address setting.
- (6) Press the ON/OFF operation button on the remote controller. (Fig. 64) Check that the "beep" signal-received sound is heard from the second indoor unit (approximately 5 times). The sound you hear is the signal that the remote controller address has been changed.
- (7) Finally press the remote controller ACL (reset) button to cancel the blinking "oP-7" display. (Fig. 64)

Changing of the second remote controller address is now completed.

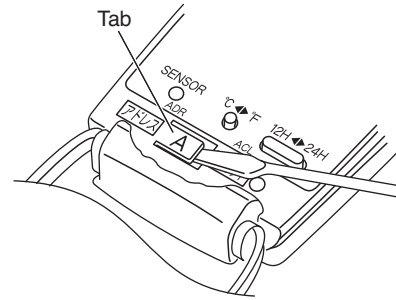

Fig. 62

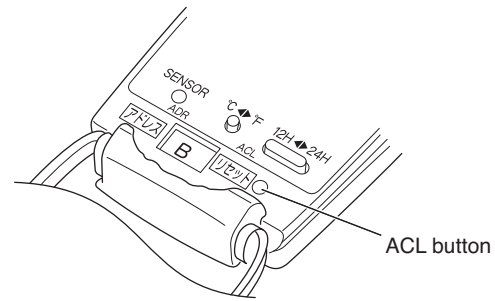

Fig. 63

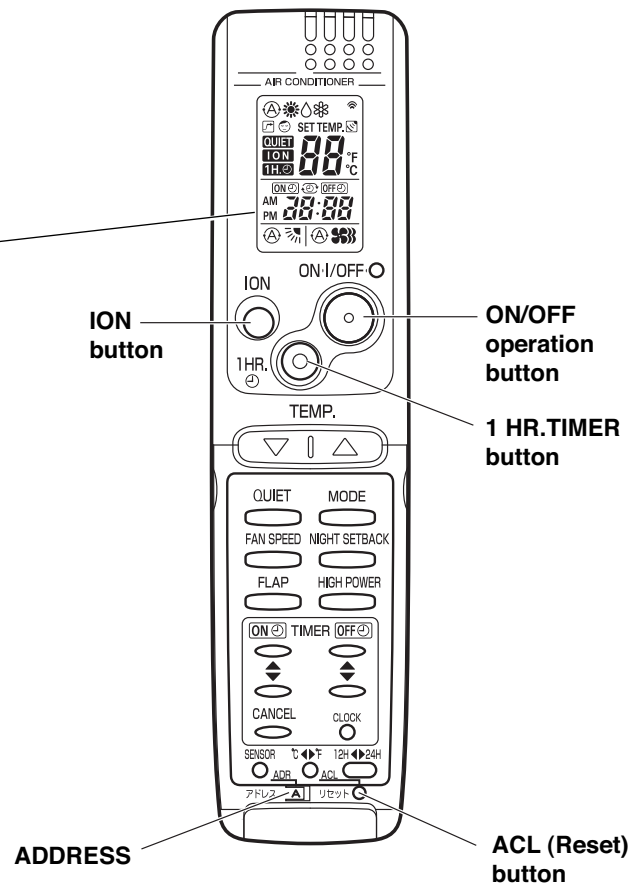
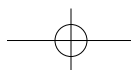
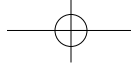

Fig. 64





8. Connecting a Home Automation device

The HA (white) 4P terminal is located on the indoor unit PCB. If a HA device will be used, connect it to this terminal.

Also, refer to Section 9. ELECTRIC WIRING DIAGRAM in the outdoor unit installation manual.

9. Installation Check Sheet

- The strength of the installation location is sufficient to support the Air Conditioner weight.
- The indoor and outdoor units are installed level and vertically.
- The power and voltage are as specified.
- Inter-unit cables are securely inserted into the terminal block.
- Inter-unit cables are securely fixed.
- The power cord and inter-unit cables are not connected anywhere along their paths.
- The ground wire is securely connected.
- Thermal insulation has been applied to the tubing connections.
- Drain connections are secure and water drains properly.
- Putty has been used to close the hole in the wall.
- Remote controller signals are being positively received.

English

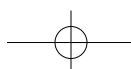
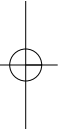

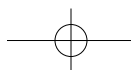
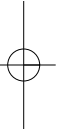
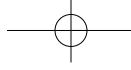

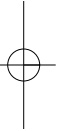
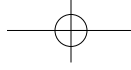

R.D. 28 Reyrieux BP 131 - 01601 Trévoux CEDEX France
Tel. (33) 04.74.00.92.92 - Fax (33)04.74.00.42.00
<http://www.technibel.com>

