

CSCF 208 / 308 / 408 LL

SPLIT CONSOLE REFRIGERATION SYSTEM FOR LOW TEMPERATURE ROOMS

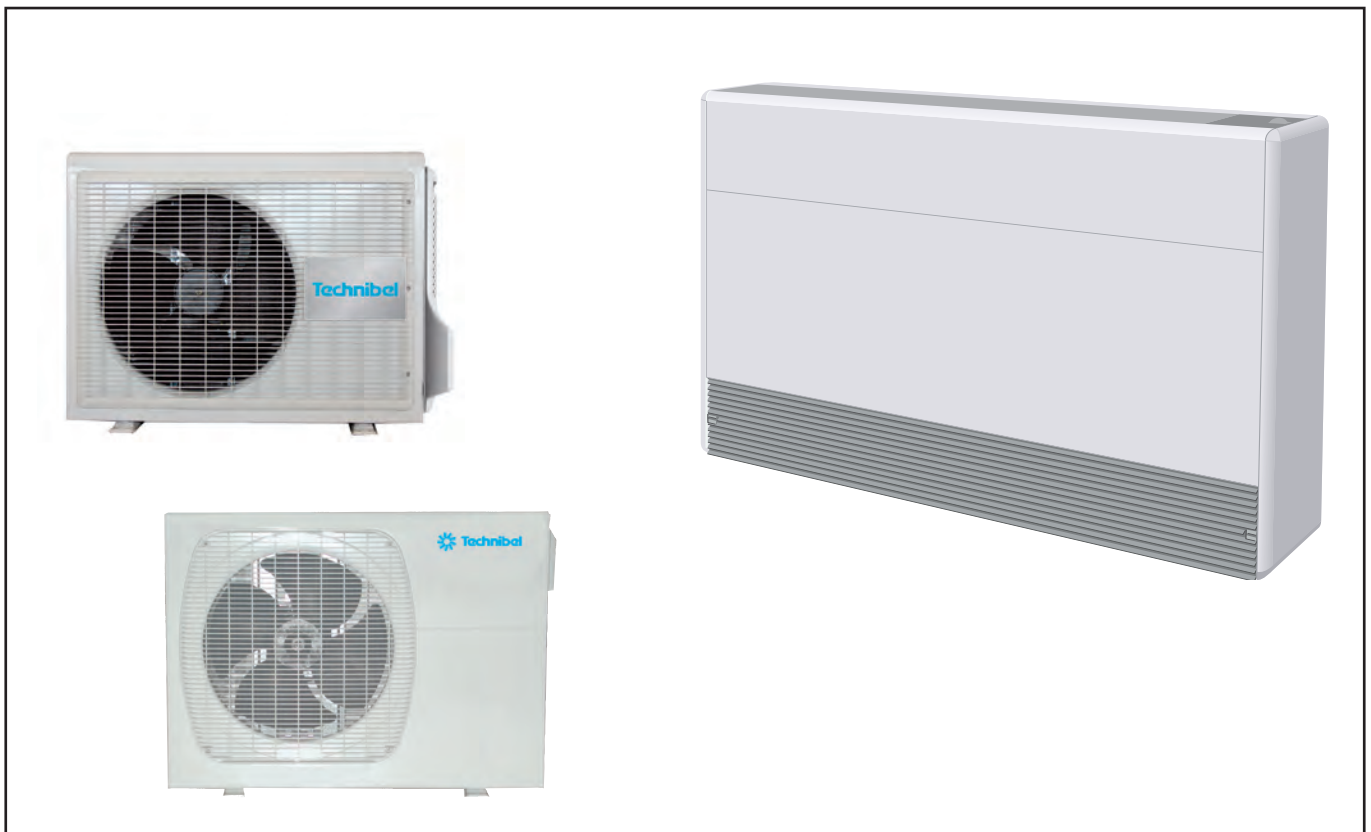

R 410 A

Cooling

CSCF 208 LL - 1.84 kW

CSCF 308 LL - 2.61 kW

CSCF 408 LL - 3.72 kW / 3.82 kW *

*** single-phase/ three-phase**

CE MARKING

This product marked  conforms to the essential requirements of the Directives:

- Low voltage no. 2006/95/EC.
- Electromagnetic Compatibility no. 2004/108/EC.



NOTE: This symbol mark and recycle system are applied only to EU countries and not applied to the countries in the other area of the world.

Your product is designed and manufactured with high quality materials and components which can be recycled and reused. At end of lifetime, it should be eliminated separately from your household waste.

Please dispose of this equipment at your local community waste collection / recycling centre.

In the European Union there are separate collection systems for used electrical and electronic products.

Please help us to conserve the environment we live in!

SUMMARY

1 - Presentation	3
2 - Technical characteristics	3
3 - Physical characteristics	4
4 - Description	5
5 - Cooling performances	7
6 - Sound levels	8
7 - Accessories	8
8 - Description of remote controls	9

APPLIANCES FILLED WITH R 410 A

R 410 A

- R 410 A is a high-pressure refrigerant (+ 50% in relation to R 22 and R 407 C).
- The compressors approved for operation with this fluid are filled beforehand with polyvinyl ether oil.

MAINTENANCE INSTRUCTIONS

- 1 - Never add oil to the appliance; the compressor is filled with polyvinyl ether (PVE) oil, a special oil which cannot tolerate the presence of other oils.
- 2 - The instruments used for:
 - filling,
 - pressure measurements,
 - emptying under vacuum,
 - recovering the fluid,must be compatible and only used for the R 410 A fluid.
Note: the pressure taps of the refrigerating circuit are 5/16 SAE (1/2 - 20 - UNF)
- 3 - In the case of a new charge:
 - The charge **must** be undertaken in liquid phase.
 - Use a balance and a dip pipe type R 410 A cylinder.

- 4 - Charge the weight of R 410 A as per the value indicated on the unit's identification plate (for "split systems", refer to the installation instructions as the charge must consider the length of the connecting lines).
- 4 - In case of leakage, do not complete the charge: recover the remaining refrigerant for recycling and perform a total charge.
Recovery, recycling or the destruction of the fluid must be done in compliance with the laws in force in the country concerned.
- 5 - If the refrigerant circuit is opened, you must:
 - Avoid the entry of air into the circuit as much as possible.
 - Replace or install a drier.
 - Perform the "vacuum operation" at a minimum level of **0.3 mbar (static)**.
- 6 - Do not release R 410 A fluid into the atmosphere. This fluid is a fluorinated greenhouse gases, covered by the Kyoto Protocol with a Global Warming Potential (GWP) = 1975 - (CE Directive 842 / 2006).

1 - PRESENTATION

1.1 - UTILISATION

- Air conditioning by independent system designed for "Low temperature" air conditioning (between 12° C and 18° C) for wine cellars, florist flower storage, trash facilities, etc...

1.2 - APPLICATIONS

- The unit may be installed vertically (floor or apron wall) or horizontally (surface-mounted ceiling installation).

1.3 - MODELS

- 3 cooling only models (with R 410 A refrigerant).

1.4 - FUNCTIONS

- Cooling.
- Ventilation with filtration.
- Heating (option).
- Dehumidification (with hygro-thermostat option).

1.5 - OPERATION

- Direct expansion refrigeration cycle.

- "SPLIT SYSTEM" layout comprising:

- an indoor air handler (TAF),
- an outdoor unit (GRF),
- the electrical and refrigerant connections between TAF and GRF.

1.6 - INDOOR UNIT

- Plastified sheet-metal casing with M1 fire-rated insulation.
- Oversized exchanger.
- 3 fan speeds.

1.7 - OUTDOOR UNIT

- Outdoor units combining:
 - high performance (rotary compressor),
 - quietness,
 - attractiveness (horizontal blowing, slim unit),
 - easy installation.
- Low-temperature version for use with outside temperatures up to -15° C.
- Expansion by capillary in the outdoor unit.

2 - TECHNICAL CHARACTERISTICS

Model				CSCF 208 LL	CSCF 308 LL	CSCF 408 LL		
Indoor unit				TAF 208 L	TAF 308 L	TAF 408 L		
Outdoor unit				GRF 98 L	GRF 128 L	GRF 188 L		
Nominal cooling capacity	HS		kW	1.84	2.61	3.72 / 3.82 **		
Nominal power consumption (*)	HS	Cooling	kW	0.86	1.16	1.68 / 1.73 **		
EER				2.14	2.25	2.21		
Electric heating power (option)			kW	2 / 3	2 / 3	2 / 3		
Nominal indoor air flow rate	HS		m³/h	860	1,150	1,260		
			m³/s	0.24	0.32	0.35		
Maximum current (*)	HS	Cooling	A	5	6.7	10.1 / 4.8 **		
			Electric heating	2 kW	A	8.7	8.7	8.7
			Electric heating	3 kW	A	13	13	13
Power supply	V/ph/Hz		230/1/50	●	●	●		
			400/3N/50	---	---	●		

Note: The nominal capacities are given for a total length of connecting pipe of 7.50 meters.

(*) In the case where the hygrothermostat is used, the electrical resistors may operate at the same time as the compressor. The cooling value and the electric heating value must thus be added together to determine the total value.

(**) Single-phase / Tri-phase.

NOMINAL OPERATING CONDITIONS

Indoor	Dry bulb temperature	12° C
	Wet bulb temperature	9° C
Extérieur	Dry bulb temperature	35° C

OPERATING LIMITS

Maximum	Indoor	Dry bulb temperature	32° C
		Wet bulb temperature	23° C
Minimum	Outdoor	Dry bulb temperature	43° C
	Indoor	Dry bulb temperature	12° C
		Wet bulb temperature	9° C
Outdoor	Dry bulb temperature	-15° C	

3 - PHYSICAL CHARACTERISTICS

3.1 - DIMENSIONS

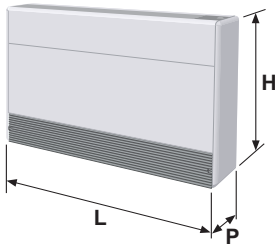

INDOOR UNIT - TAF			TAF 208 L	TAF 308 L	TAF 408 L
Dimensions	L	mm	950	1,140	1,260
	H	mm	600	600	600
	P	mm	235	235	235
	Weight	kg	37	42	45
Dimensions packaged	L	mm	1,010	1,200	1,320
	H	mm	650	650	650
	P	mm	295	295	295
	Weight	kg	43	49	52

GRF 98 L / 128 L

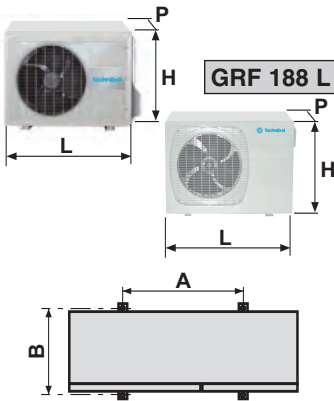

OUTDOOR UNIT - GRF			GRF 98 L	GRF 128 L	GRF 188 L
Dimensions	L	mm	700	700	830
	H	mm	540	540	630
	P	mm	265	265	305
	A	mm	470	470	538
	B	mm	294	294	307
	Weight	kg	34	34	55
Dimensions packaged	L	mm	815	815	971
	H	mm	568	568	690
	P	mm	343	343	388
	Weight	kg	37	37	60

3.2 - LOCATION OF MOUNTS AND CONNECTIONS OF INDOOR UNIT

	A (mm)	B (mm)	C (mm)	D (mm)	E (mm)
TAF 208 L	950	850	790	600	310
TAF 308 L	1,140	1,040	980	600	310
TAF 408 L	1,260	1,160	1,100	600	310

NOTE:
The refrigeration connections are located on the left side of the unit, inside the housing.

4 - DESCRIPTION

Model	CSCF 208 LL	CSCF 308 LL	CSCF 408 LL
INDOOR UNIT	TAF 208 L	TAF 308 L	TAF 408 L
Construction			
Galvanised steel and plastic coated sheet	●	●	●
M1 class polyethylene insulation	●	●	●
Evaporator			
Copper/aluminium evaporator with LOUVER fins	●	●	●
Number of circuits	3	3	3
Expansion system	in GR	in GR	in GR
Refrigerant circuit			
Non-filled internal refrigerant circuit	●	●	●
Flare type connection	1/4" (6.35 mm)	1/4" (6.35 mm)	1/4" (6.35 mm)
	3/8" (9.52 mm)	1/2" (12.7 mm)	1/2" (12.7 mm)
Condensate drain pan			
Material: galvanised steel with polyethylene insulation	●	●	●
Outside dia. of drain tube connection	16	16	16
Fan			
Centrifugal fan	●	●	●
Number of twin blade turbines	2	2	2
Diameter	146	146	146
Total air flow	HS	MS	LS
	860	740	540
	1,150	1,000	780
	1,260	1,160	930
Motor			
3-speed electric motor with internal thermal protection	●	●	●
Power supply	V/ph/Hz	230/1/50	●
Current	HS	A	0.6
Power input	HS	kW	0.12
Rotation speed	HS	rpm	1,240
Air filter			
Type: polyurethane foam PPI 20, placed behind the suction grille	●	●	●
Classification EUROVENT 4/5	EU1	EU1	EU1
Number	1	1	1

Model	CSCF 208 LL	CSCF 308 LL	CSCF 408 LL
OUTDOOR UNIT	GRF 98 L	GRF 128 L	GRF 188 L
Fan motor			
Direct drive propeller fan motor	●	●	●
Number	1	1	1
Diameter mm	370	370	400
Power supply V/ph/Hz 230/1/50	●	●	●
Rotation speed rpm	800	830	910
Current A	0.28	0.28	0.41
Power input kW	0.063	0.063	0.087
Compressor			
Hermetic compressor with: thermal protection and sound insulation cover	Rotary compressor	Rotary compressor	Rotary compressor
Oil type	RB68A or equivalent	RB68A or equivalent	FS50S or equivalent
Crankcase heater	---	●	●
Power supply V/ph/Hz 230/1/50	●	●	●
400/3N/50	---	---	●
Maximum current A	3.6	5.09	7.72
A	---	---	3.32
Maximum power input kW	0.79	1.16	1.79
kW	---	---	1.94
Condenser			
Plate-fin condenser with LOUVER fins	●	●	●
Refrigerant circuit			
Filled internal refrigerant circuit	●	●	●
Flare type connection Liquid line	1/4" (6.35 mm)	1/4" (6.35 mm)	1/4" (6.35 mm)
Gas line	3/8" (9.52 mm)	1/2" (12.7 mm)	1/2" (12.7 mm)
R 410 A refrigerant			
Charge supplied in the unit g	770	790	1,260
Charge to be systematically added for connections up to 7.50 metres g	90	100	130

Model	CSCF 208 LL	CSCF 308 LL	CSCF 408 LL
REFRIGERANT CONNECTIONS	GRF 98 L	GRF 128 L	GRF 188 L
Max. length with charge increase m	15	20	20
Max. elevation m	7	7	15

5 - COOLING PERFORMANCES

CSCF
208 LL

TOTAL COOLING CAPACITY

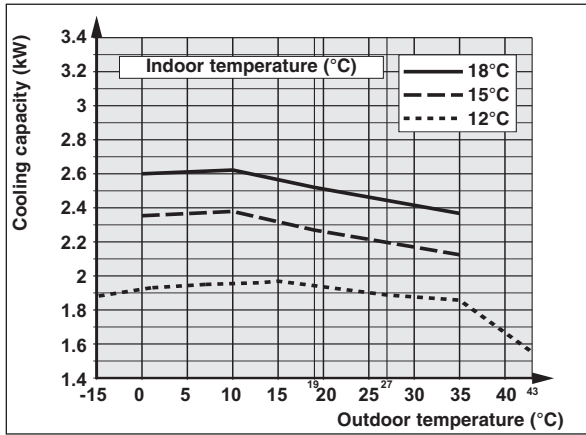

TOTAL POWER CONSUMPTION

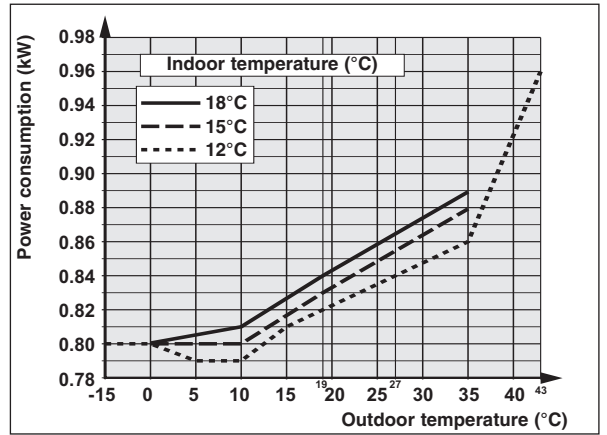

CSCF
308 LL

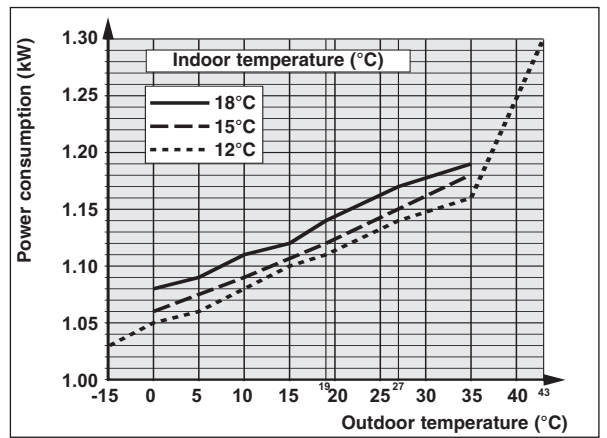
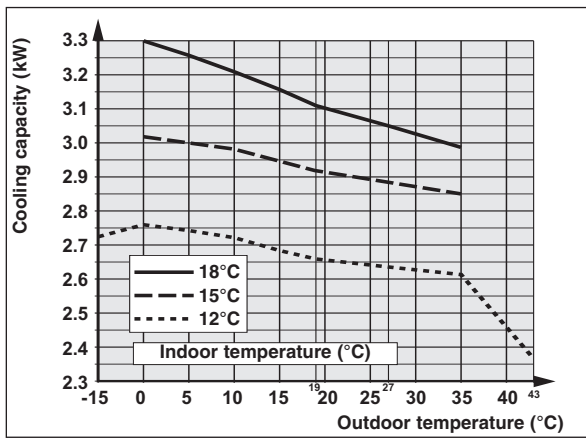

CSCF
408 LL
Single

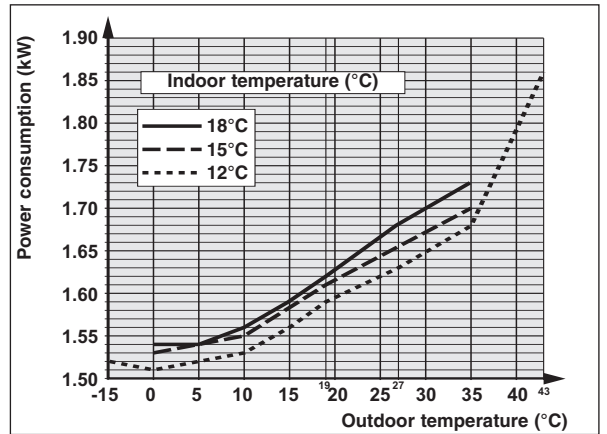
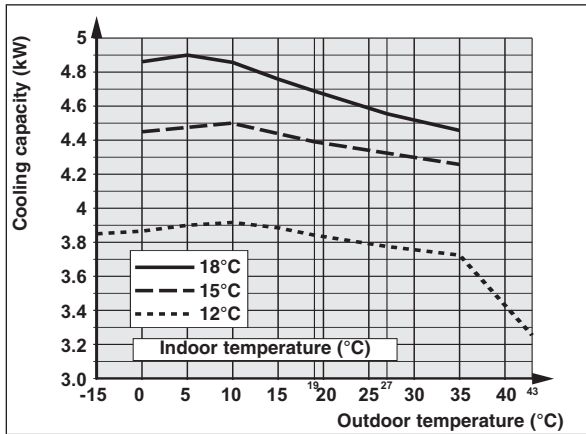

CSCF
408 LL
Three

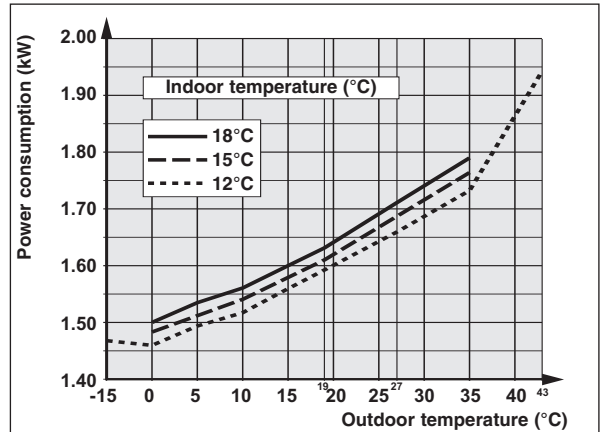
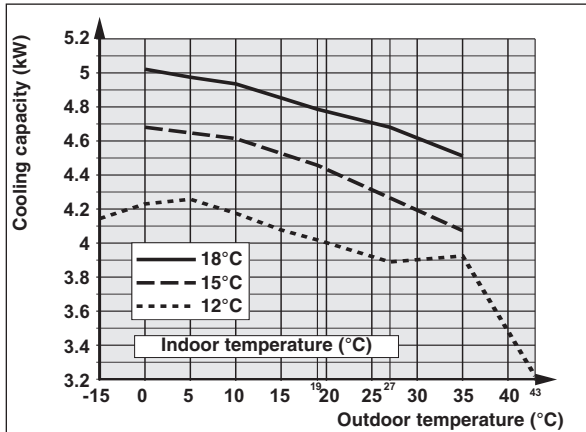

Cooling capacity correction factor according to air flow rate:
 High speed: 1 Medium speed: 0.96 Low speed: 0.93

6 - SOUND LEVELS

6.1 - SOUND LEVELS

Unit	LW (dBA)			LP (dBA)		
	LS	MS	HS	LS	MS	HS
TAF 208 L	52	59	64	44	51	56
TAF 308 L	55	60	66	47	52	58
TAF 408 L	57	62	64	49	54	56
GRF 98 L	---	---	57	---	---	37
GRF 128 L	---	---	60	---	---	40
GRF 188 L mono	---	---	63	---	---	43
GRF 188 L tri	---	---	64	---	---	44

• LW : Sound power level.

• LP : Sound-pressure level.

(Given as an indication only. Recalculate it according to installation conditions).

6.2 - MEASURING CONDITIONS

• **Indoor unit (TAF)**

- free field,
- distance 2 m.

• **Outdoor unit (GRF)**

- fitted on the floor,
- free field,
- distance 4 m.

7 - ACCESSORIES

Accessory	CSCF 208 LL	CSCF 308 LL	CSCF 408 LL
Wall support for indoor unit	●	●	●
Electric heating	2 kW 230/1/50	●	●
	3 kW 230/1/50	●	●
Manual remote control	●	●	●
Automatic remote control	●	●	●
Remote hygrothermostat *	●	●	●
Bare air temperature sensor for automatic control	●	●	●
Air temperature sensor in box for automatic control	●	●	●
Wall support for outdoor unit	●	●	●

(*) If a hygrothermostat is used, the electric heater accessory is obligatory.

8 - DESCRIPTION OF REMOTE CONTROLS

8.1 - RAB 30 MANUAL CONTROL - Code K 60 D 076 Z

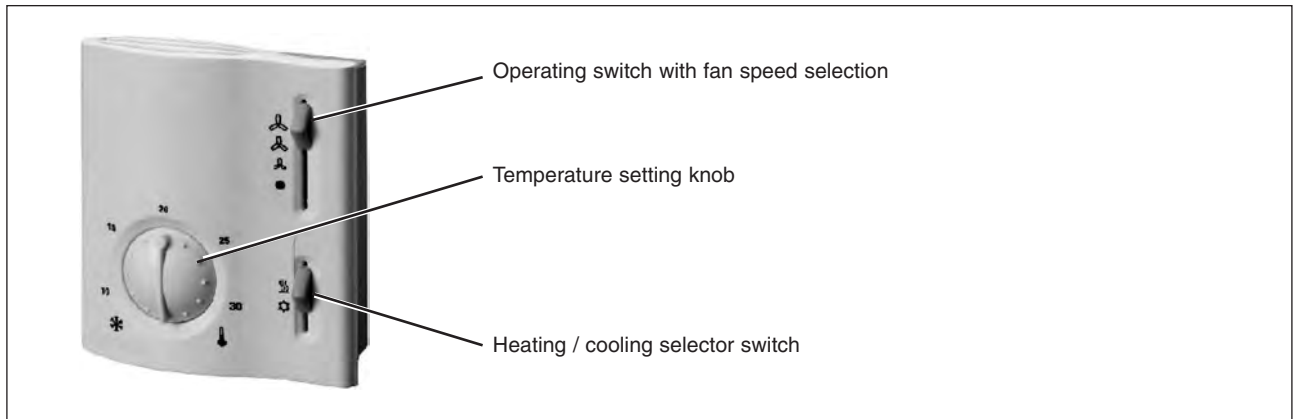

8.2 - AUTOMATIC CONTROL - Code K 60 D 025 Z

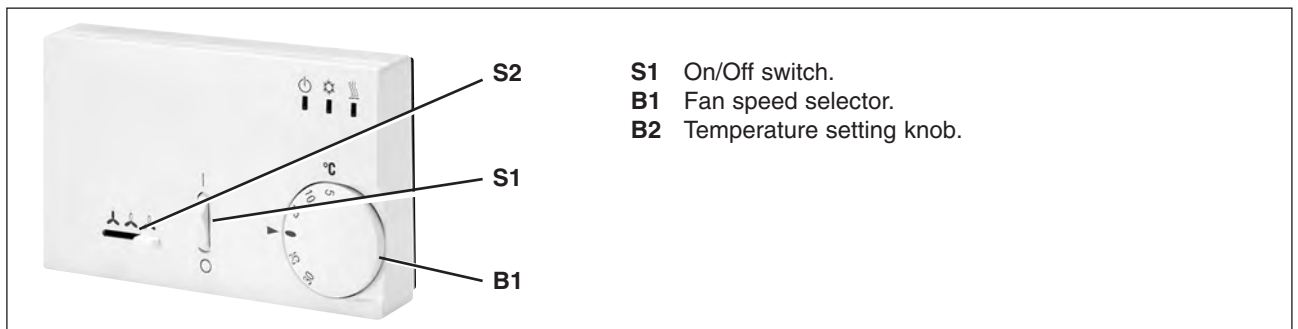

8.3 - HYGROTHERMOSTAT - Code K 60 D 047 Z

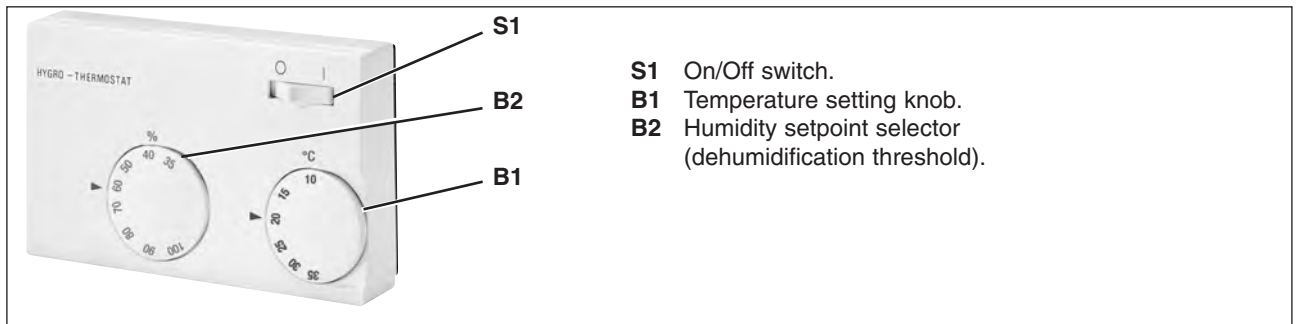

Theory of operation:

- This remote control contains both a thermostat (settings: 10/35°C) and a hygostat (settings: 35/100% relative humidity). The hygostat is used for the "Dehumidification" function.
Cooling is triggered by a request from the thermostat or the hygostat.
- **IMPORTANT: As cooling and heating control signals are provided by the same change-over contact, there is not neutral zone. The unit thus operates permanently to maintain the required temperature (differential $\approx 1^{\circ}$).**
Depending on the surrounding conditions, it is possible to encounter simultaneous operation of the heater, requested by the thermostat, and of the air conditioner, requested by the hygostat (dehumidification).
- An external humidifier, not supplied, may be controlled by the hygostat by relaying the humidification signal (230 VAC - relay not supplied).



Due to our policy of continuous development, our products are liable to modification without notice.

Technibel

Z.I. Route départementale 28
CS 40131 Reyrieux
01601 Trévoux Cedex France
Phone 33 4 74 00 92 92 - Fax 33 4 74 00 42 00
R.C.S. Bourg-en-Bresse B 759 200 728