

TECHNICAL DATA & SERVICE MANUAL

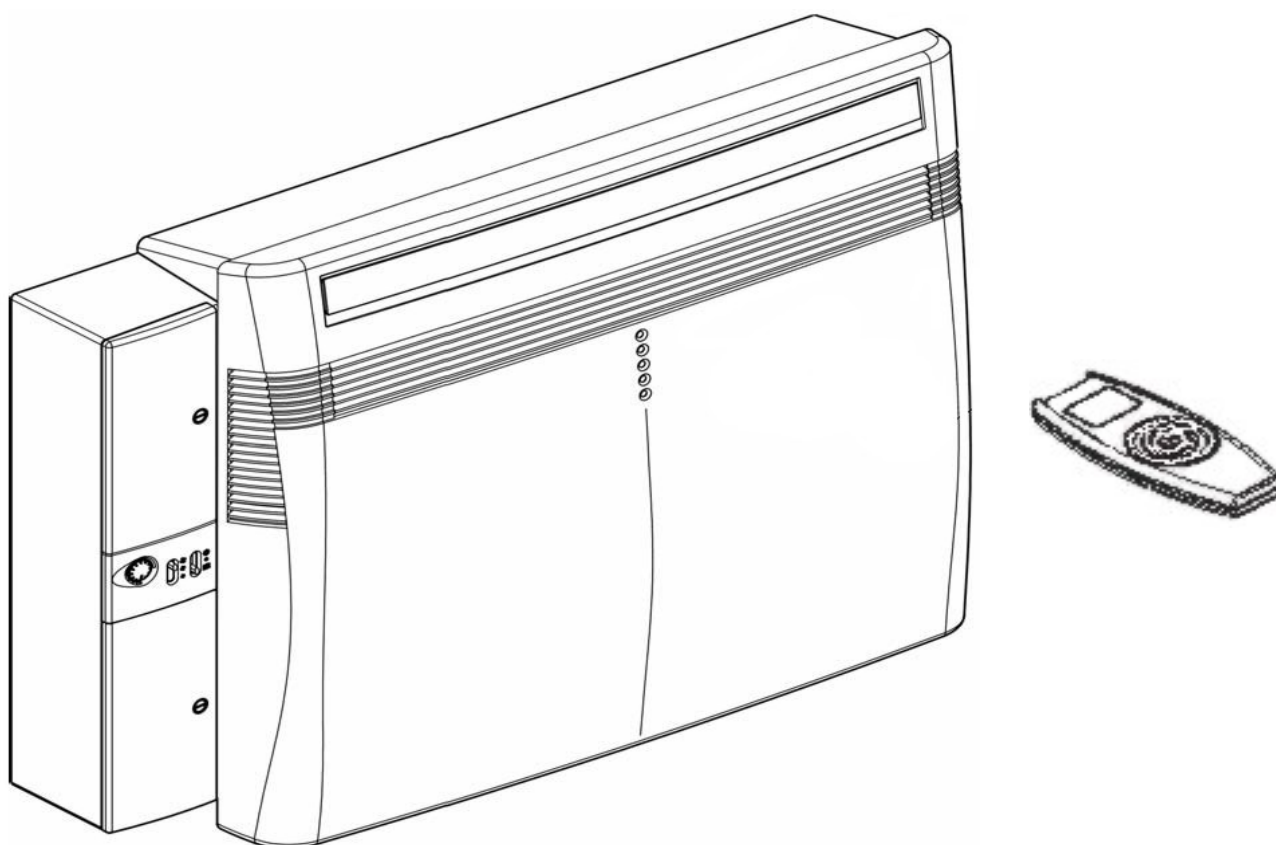

REVE 247C (I) Cooling only model

REVE 237R (I) Heat pump model

Table of contents

	Page
A SPECIFICATIONS	
1) Unit specifications	3
2) Major Component specifications	4
B OPERATING RANGE	5
C DIMENSIONAL DATA	6
D PERFORMANCE CHARTS	7
E REFRIGERANT FLOW DIAGRAMS	10
F FUNCTIONS	
1) Cool Mode Operation	11
2) Heat Mode Operation	12
3) Auto Mode Operation	13
4) Dry Mode Operation	14
5) Fan Mode Operation	14
6) Auto Fan Speed	14
7) Forced Mode	15
8) Protection operations in Cool and Dry Mode	15
9) Protection operation in Heat Mode	16
10) I Feel Function	18
11) Night Function	18
12) Diagnostic	19
13) Jumpers	20
14) Contacts for building automatio	21
15) Maintenance	21
16) Manual Unit Control and Led Indicators	22
17) Outdoor fan operation	23
18) Drain Pump	24
G ELECTRIC WIRING DIAGRAMS	25
H TROUBLESHOOTING	27
I REFRIGERANT CHARGE	35
L CHECKING ELECTRICAL COMPONENTS	
1) Measurement of Insulation Resistance	36
2) Checking Continuity of Fuse on PCS Ass'y	37
3) Checking Motor Capacitor	37
M BOILER CONNECTION KIT	
1) Specifications and operating limits	38
2) Performance charts	39
3) Component specifications	40
4) Hydraulic connections and valves	41

A SPECIFICATIONS

1) UNIT SPECIFICATIONS

UNIT MODEL		REVE 247C	REVE 237R	
Power source		220 - 240 V 50 Hz		
PERFORMANCES		COOLING	COOLING	HEATING
Capacity (air conditioner)	BTU / h	8360	8020	7700
	kW	2,45	2,35	2,25
Capacity (hot-water system)	BTU / h	7160		
	kW	2,1		
Air circulation (high/med/low)		m ³ / h		330-300-280
Moisture removal (high speed)		l / h	1,0	---
Dry 27°C (60% R.U.)		liters / 24h	30	---
30°C (80% R.U.)		liters / 24h	59	---
ELECTRICAL RATINGS				
Voltage rating		V	220 - 240	
Available voltage range		V	198 - 264	
Running Ampere (air conditioner)		A	4,3	4,2
Running Ampere (hot-water system)		A	0,10	
Power input (air conditioner)		W	935	900
Power input (hot-water system)		W	27	
Power factor			0,95	0,93
C.O.P			2,62	2,61
Compressor locked rotor amperes		A	17	
FEATURES				
Controls / temperature control		Microprocessor / I.C. Thermostat		
Control unit		Wireless remote control unit		
Timer		ON / OFF 24 hours and program		
Fan speed (air conditioner)		3 + Auto		
Fan speed (hot-water system)		3		
Airflow direction (Indoor)	Horizontal	Auto (manual for hot water system)		
	Vertical	Manual		
Air filter		Washable, easy access		
Compressor		Rotary (hermetic)		
Refrig./Stand. Charge at shipmen		R410A	600g	520g
Refrigerant control		Capillary tube		
Sound pressure level (Indoor)	Air conditioner Hi/Me/Lo dB(A)	45-43-41		
	Hot-water system Hi/Me/Lo dB(A)	42-39-32		
Sound pressure level (outdoor)	Air conditioner Hi dB(A)	53 at 4 m.		
	Air conditioner Lo dB(A)	48,5 at 4 m.		
Ducts diameter (2pcs)		mm 162		
Water connections diameter onli models 245C / 235H		1/2" Gas		
Condensate drain system		Not requested	By duct	
DIMENSIONS AND WEIGHT				
Height		mm	735	
Widht		mm	839	
Depht		mm	260-280	
Holes diameter in the wall (2)		mm	162	
Net weight		kg	50 / 48,75	52 / 50,75

Data can be changed without notice

NOTE

Rating conditions:

Cooling: outside air temp.: 35° C DB, indoor air temp.: 27° C DB, 19° C WB
Heating: outside air temp.: 7° C DB, 6° C WB, indoor air temp.: 20° C DB

2) MAJOR COMPONENT SPECIFICATIONS

UNIT MODEL		REVE 247C	REVE 237R
CONTROLLER (PCB)			
Part No.		SAC ON-OFF IDU	
Controls		Microprocessor	
Control circuit fuse (F1)		250VAC - 5A -T	
Jumper Setting JP1....JP5 (see Electric wiring diagram)		2,54mm - 5 pcs	2,54mm - 5 pcs
SWITCH INDICATOR ASSY			
Model		PCB	
Led color		384208021	
TMR : blu - STB : yellow - OPR : green			
REMOTE CONTROL UNIT			
Model		SAC W-REM	
THERMISTOR (COIL SENSOR) TH1			
Resistance (at 25° C)		NTC (with brass pipe)	
	kΩ	10 ± 3%	
THERMISTOR (ROOM SENSOR) TH2			
Resistance (at 25° C)		10 ± 5%	
	kΩ		
THERMISTOR (AIR SENSOR) TH5			
Resistance (at 25° C)		10 ± 5%	
	Kω		
FAN & FAN MOTOR (FMI)			
Model		K35406-MO2024	
Number / Diameter / Length		mm	
Cross-flow 1 / Ø100 / 515			
No. of pole / rpm (230 V, high)		4 / 1350	
Nominal input		W	
30			
Coil resistance (at 25° C)		Ω	
GRY-WHT: 545±630			
WHT-VLT: 92±105			
VLT-ORG: 62±71			
GRY-BRN: 78±90			
Safety device		(Internal bimetallic type)	
Setting		°C	
Open		150 ± 10K	
Close		Autoreset	
Run capacitor (C2)		μF	
1,5			
VAC		440	
FAN & FAN MOTOR (FMO)			
Model		D2E 146 - HS03 - 46	
Number / Diameter / Length		mm	
Centrifugal 1 / Ø146 / 140			
No. of pole / rpm (230 V)		2 / 2060	
Nominal input		W	
180			
Coil resistance (at 25° C)		Ω	
BLU-BRN: 74± 5%			
BLU-BLK: 66± 5%			
Safety device		(Internal bimetallic type)	
Setting		°C	
Open		150 ± 5K	
Close		Autoreset	
Run capacitor (C3)		μF	
5			
VAC		420	
COMPRESSOR (CM)			
Model		Rotary (Hermetic)	
5PS102EAA			
Nominal cooling capacity		W	
2350			
Compressor oil RB68A or Freol Alpha68M		cc	
350			
Coil resistance (at 20° C)		Ω	
C-R : 3.863			
C-S : 3.309			
Run capacitor (C1)		μF	
30			
VAC		450	
Overload relay (OLR)			
Operating temperature		External	
Open		°C	
148 ± 5°C			
Close		°C	
69 ± 9°C			
Operating amp. (Ambient temp. 25° C)		Trip in 6 to 16 sec. at 16A	

UNIT MODEL		REVE 247C	REVE 237R
CONDENSATE PUMP (PC)			
Model		291036	
Rating		220-240VAC~50Hz	
Nominal input		5W - 0,05A	
Coil resistance (at 20° C)	Ω	778 ± 8%	
SAFETY FLOAT SWITCH (FS)			
Model		BI 1300 2725	
Contact rating		230 V AC/DC - 0,5 A	
FLAP MOTOR (FLP)			
Type		Stepping motor	
Model		MP24GA1	
Rating		DC 12V	
Coil resistance (Ambient temp. 25°C)	Ω	WHT-BLU (respectively 4 wires) : 380 ± 7%	
4 WAYS VALVE (20S)			
Model		---	SQ-136
Coil rating		---	AC 220V, 50 Hz, 6W
Coil resistance (Ambient temp. 20°C)	Ω	---	1440 ± 5%
HEAT EXCHANGER COIL (EVAPORATOR)			
Coil		Aluminium plate fin / copper tube	
Rows		3	
Fin pitch	mm	1,6	
Face area	m ²	0,107	
HEAT EXCHANGER COIL (CONDENSER)			
Coil		Aluminium plate fin / copper tube	
Rows		4	
Fin pitch	mm	1,3	
Face area	m ²	0,111	
THERMOSTATIC VALVE DRAIN PAN			
Model		---	DP 25-1101-07 or DP 25-1107
Open	°C	---	4,4
Close	°C	---	15,5
Stroke	mm	---	5,16

B OPERATING RANGE

Cooling only model

	Temperature	Indoor air intake temp.	Outdoor air intake temp.
Cooling	Maximum	32° C DB/ 23° C WB	43° C DB
	Minimum	19° C DB/ 14° C WB	19° C DB
Dry	Maximum	32° C BS/ 80% R.U.	43° C DB
	Minimum	16° C BS/ 80% R.U.	16° C DB

Heat pump model

	Temperature	Indoor air intake temp.	Outdoor air intake temp.
Cooling	Maximum	32° C DB/ 23° C WB	43° C DB
	Minimum	19° C DB/ 14° C WB	19° C DB
Heating	Maximum	27° C DB	24° C DB / 18° C WB
	Minimum	//	-8° C DB / -9° C WB
Dry	Maximum	32° C BS/ 80% R.U.	43° C DB
	Minimum	16° C BS/ 80% R.U.	16° C DB

D**PERFORMANCE CHARTS****REVE 247C Cooling only model**

Conditions: Power source
Indoor air velocity

230 V - 1- 50 Hz - Single phase
High speed

Cooling characteristics
Indoor relative humidity 48%

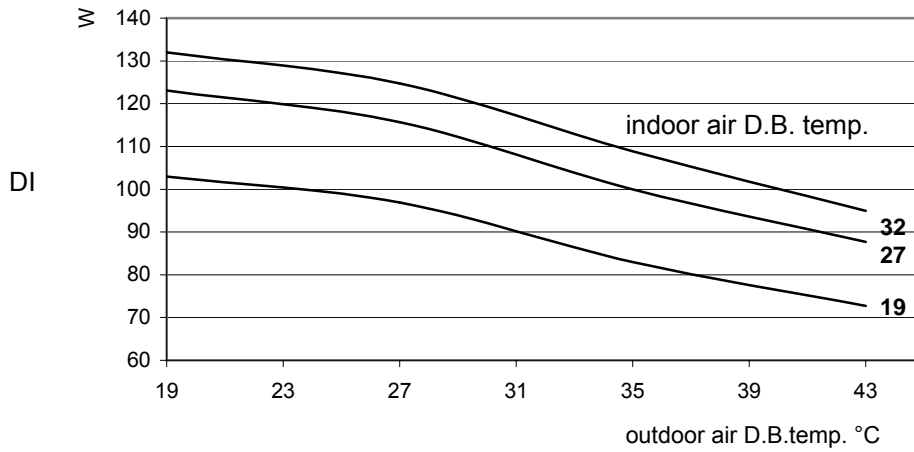
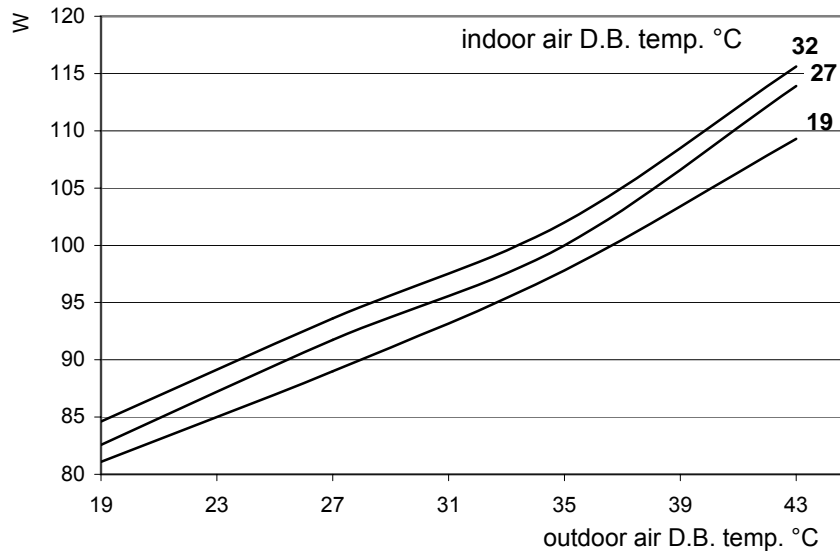
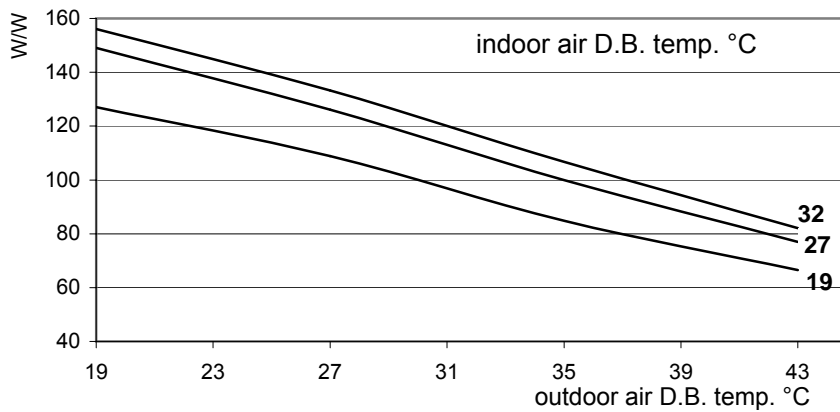
Capacity (%)**Power input (%)****E.E.R. (%)**

REVE 237R Heat pump model

Conditions: Power source
Indoor air velocity

230 V - 1- 50 Hz - Single phase
High speed

Cooling characteristics
Indoor relative humidity 48%

Capacity (%)

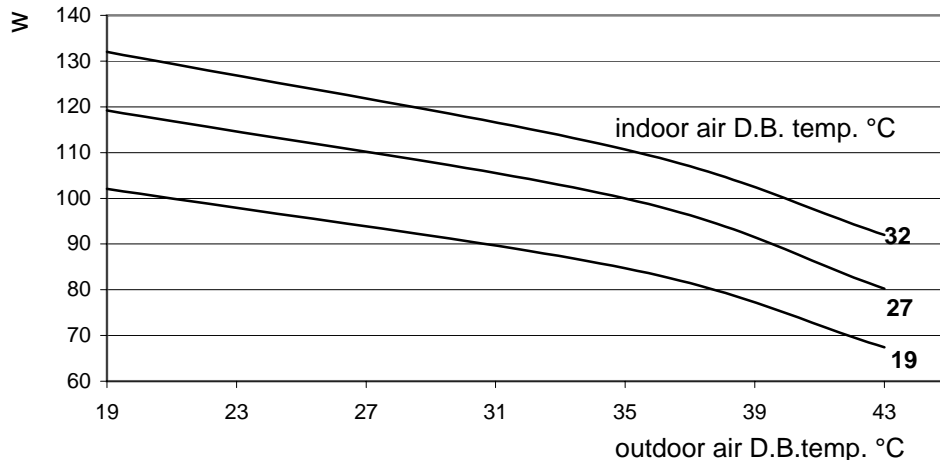

Power input (%)

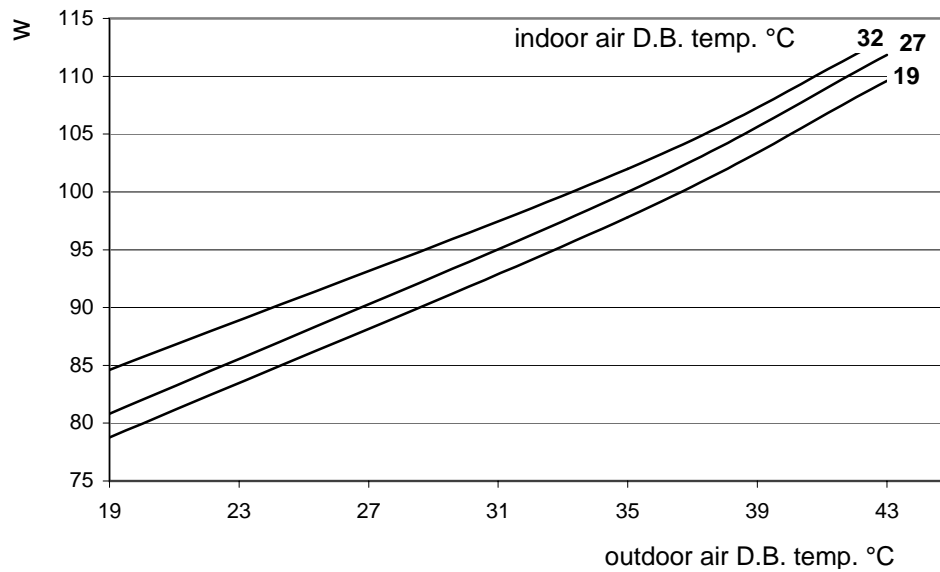

E.E.R. (%)

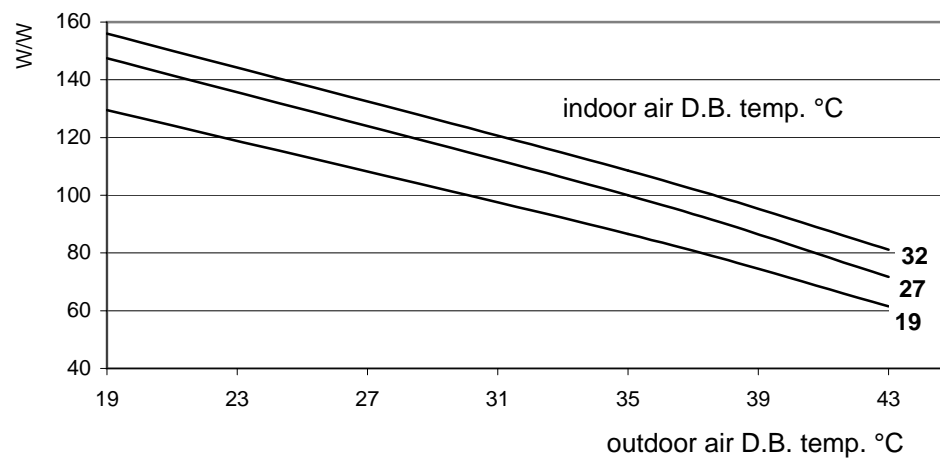

Heating characteristics

Outdoor relative humidity 85%

Capacity (%)

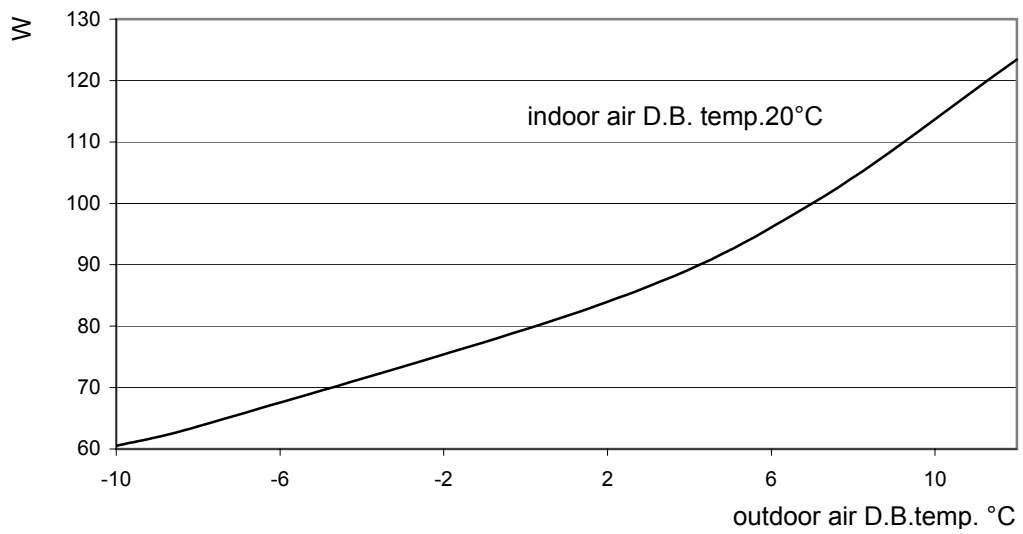

Power input (%)

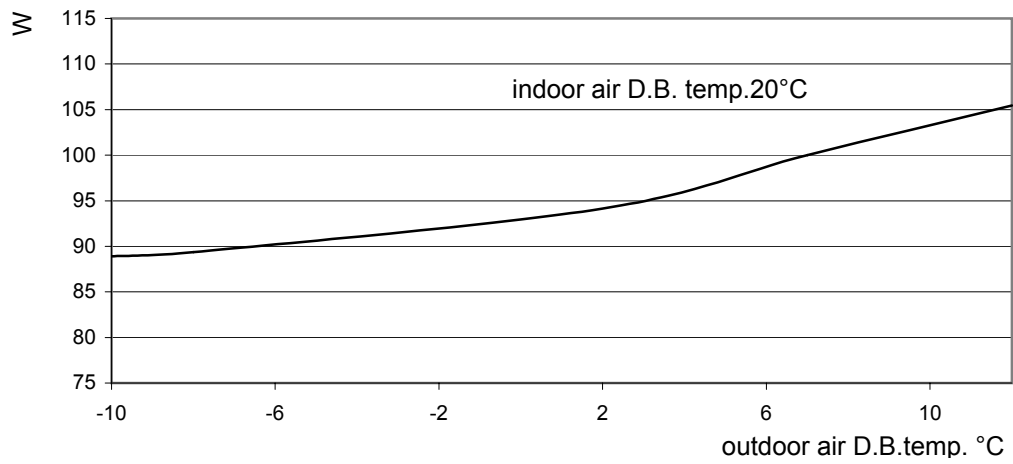

COP (%)

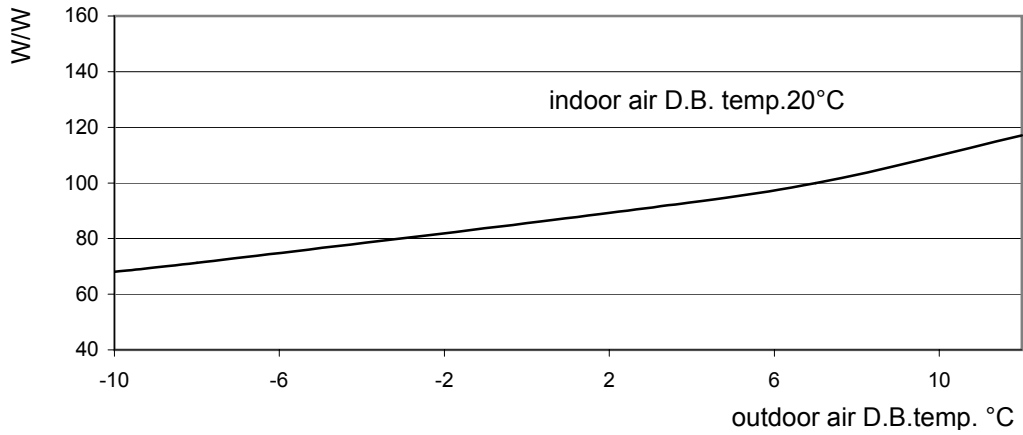

E REFRIGERANT FLOW DIAGRAM COOLING MODEL

REVE 247C

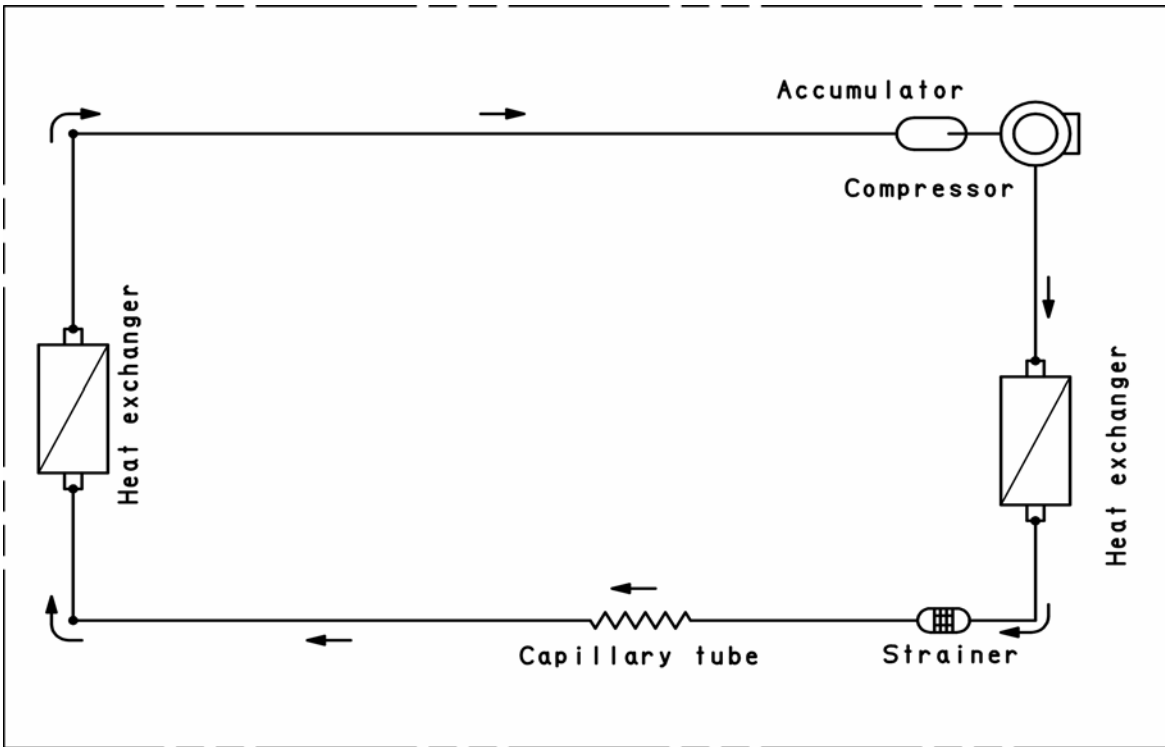

REFRIGERANT FLOW DIAGRAM HEAT PUMP MODEL

REVE 237R

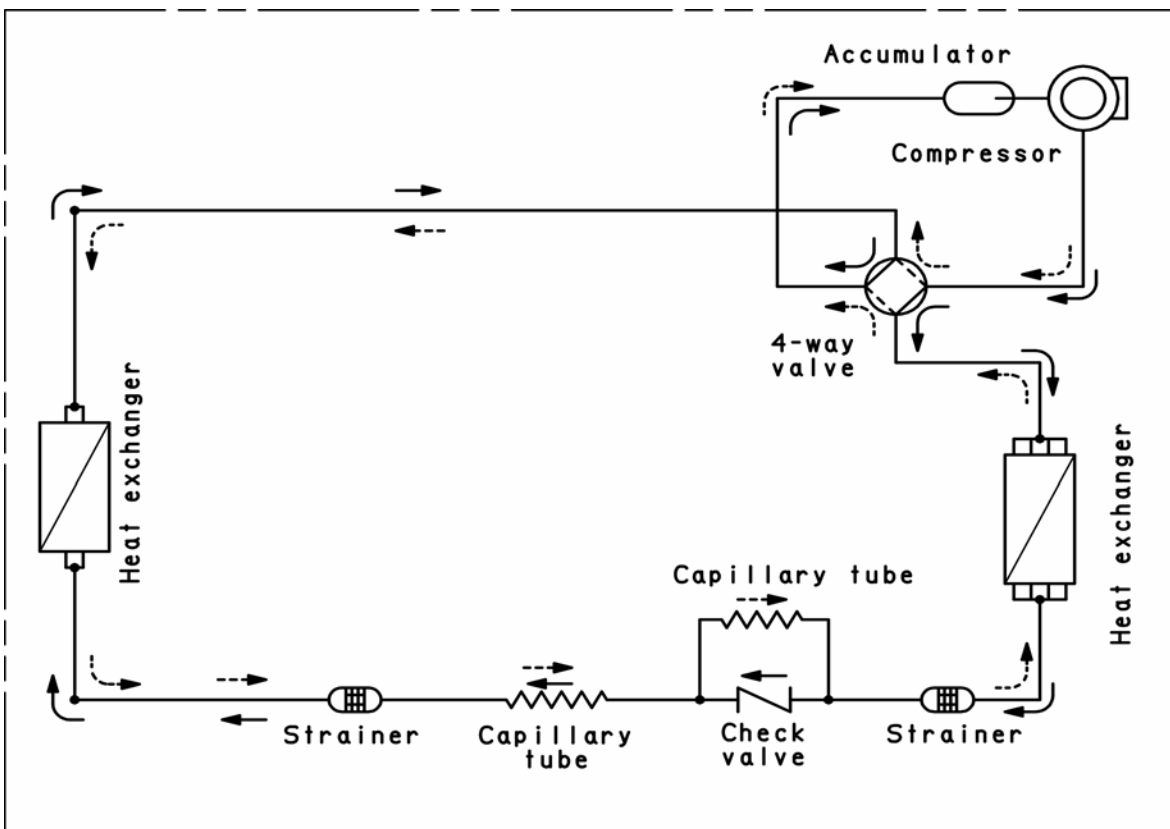

Cooling cycle ←
Heating cycle →

F FUNCTIONS

1) Cool Mode Operation

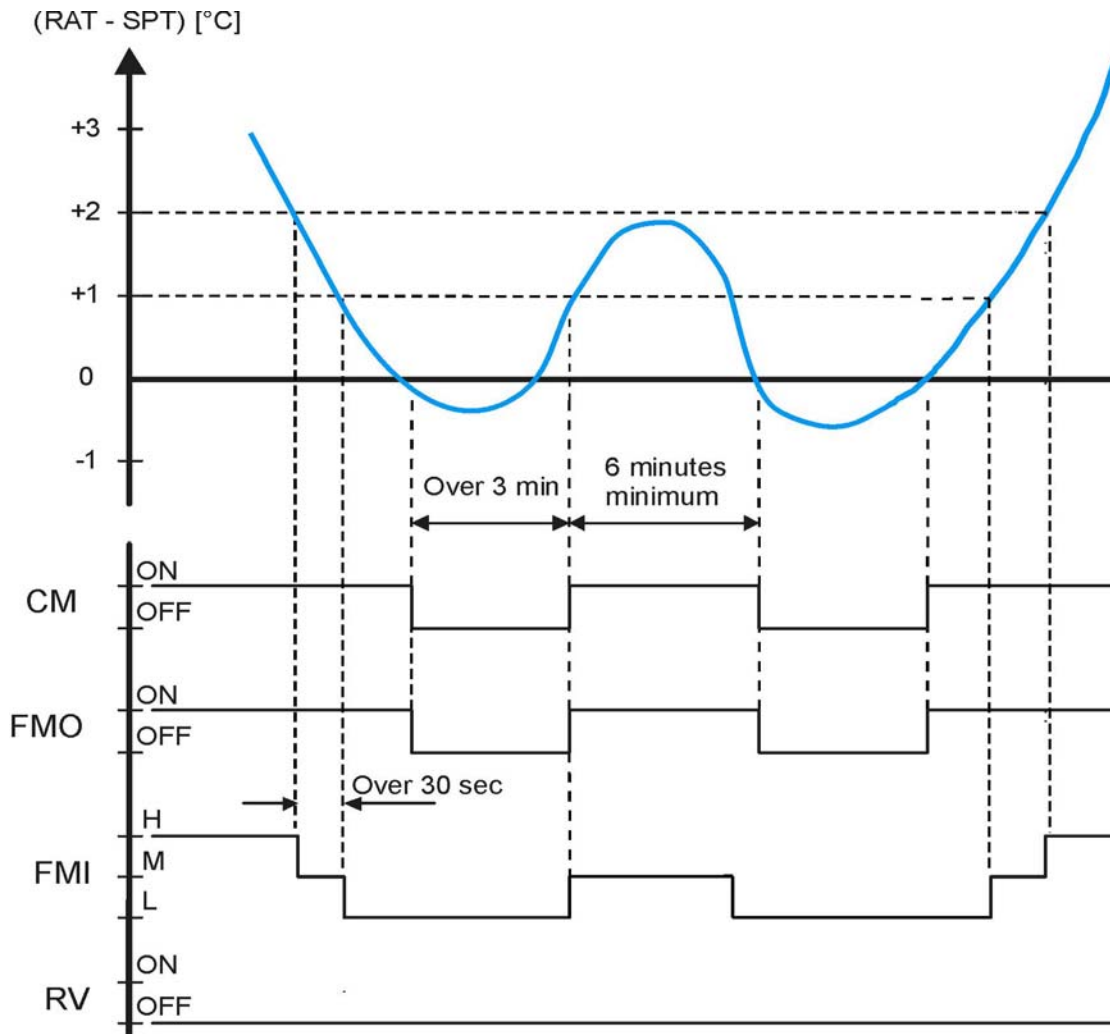

In Cooling Mode, the operation of the compressor (CM), Outdoor Fan (FMO) and Indoor Fan (FMI) are determined by the difference between the room air temperature (RAT) and the set point temperature (SPT) as shown in the graph.

NOTES

1. In this graph, the FMI is operating with the "Auto Fan Speed" setting. If the user has selected the Low, Medium or High fan speed, the FMI will run constantly at that speed only.
2. In addition to the temperature difference of above, the operations of the main components (CM, FMO, FMI) is also controlled by protection delays. That is: - the minimum off time of compressor is 3 minutes. - the minimum off time of compressor is 3 minutes. - the indoor fan can change speed only after it has operated at the same speed for 30 sec if in AUTO and 1 sec for the other settings (High, Med, Low).

2) Heat Mode Operation

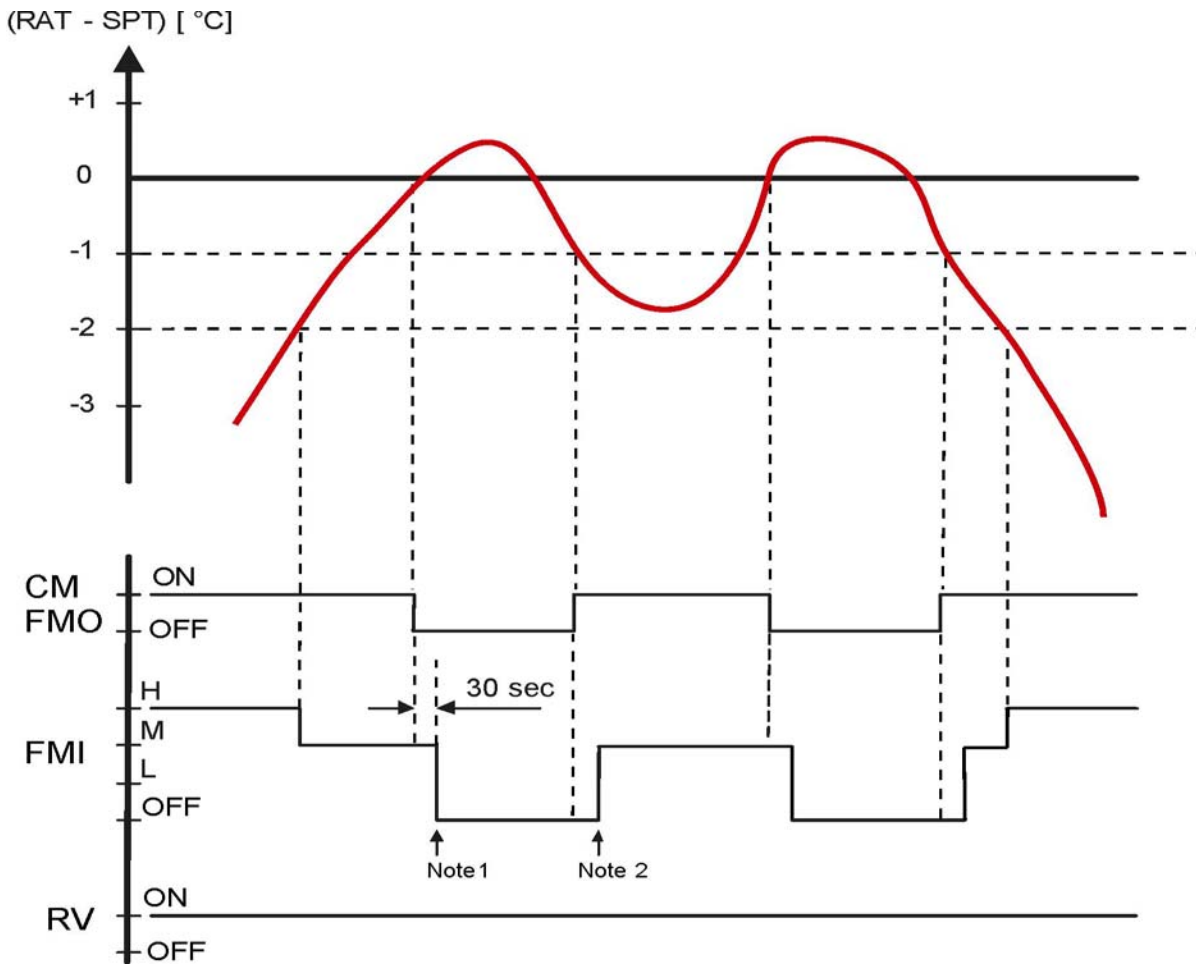

The Heating mode operation is similar to the Cooling mode operation. The CM, FMO and FMI are mainly controlled by the value of $(RAT - SPT)$. In the graph above, the FMI is operating in AUTO speed mode. Therefore, the FMI speed changes automatically according to the $(RT - SPT)$.

NOTES

1. After the CM has stopped, the FMI runs for 30s in order to purge heat from the indoor coil.
2. The FMI will not be turned on until the indoor coil temperature is warm enough to prevent the supply of cool air (see COLD DRAFT PREVENTION feature for details).
The indoor fan can change speed only after it has operated at the same speed for 30 sec if in AUTO and 1 sec for the other settings (High, Med, Low).

3) Auto Mode Operation

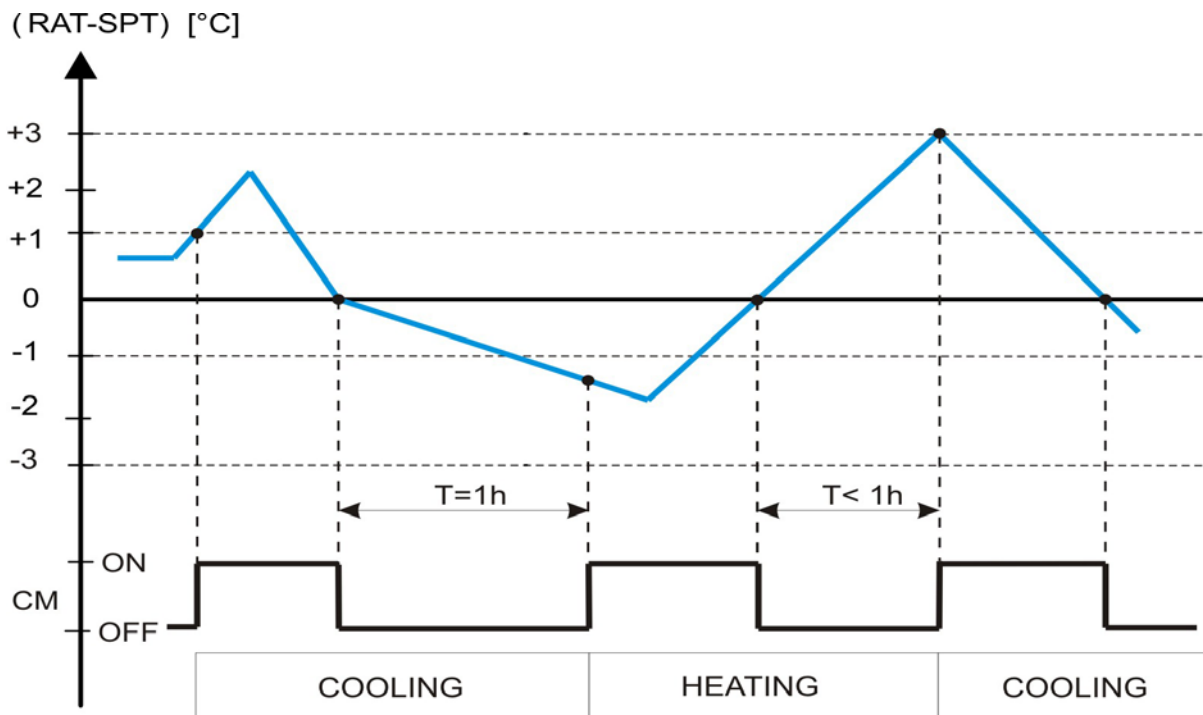

In Auto Mode, the unit switches automatically between the Auto Cooling and Auto Heating in order to maintain the room temperature (RAT) at the prescribed set point (SPT). The switching between the two modes is according to the above graph. Refer to the sections 1.COOLING MODE and 2.HEATING MODE for system operation details.

4) Dry Mode Operation

Dry operation remove moisture from indoor air running, in cooling mode, at a low level without reducing the ambient temperature. This is done cycling ON and OFF indoor and outdoor units according to below.

ROOM TEMP	DRY LEVEL	
$\geq \text{SPT}+2^{\circ}\text{C}$	LEVEL 0	Operation according to COOLING mode
$< \text{SPT}+2^{\circ}\text{C}$ $\geq \text{SPT}-1^{\circ}\text{C}$	LEVEL 1	CM on FMO on FMI switches between L and off (30 seconds) RV off
$< \text{SPT}-1^{\circ}\text{C}$ $\geq 15^{\circ}\text{C}$	LEVEL 2	CM switches 9 minutes off and 3 minutes on FMO switches 9 minutes off and 3 minutes ON FMI switches off and L during CM operation RV off
$< 15^{\circ}\text{C}$	DRY OFF ZONE	CM off FMO off FMI off RV off

SPT = Set Point Temperature

5) Fan Mode Operation

With this mode, the indoor fan is turned on while CM, FMO and RV stay off all the time. The user can select between 3 speeds: HIGH, MEDIUM and LOW.

6) Auto Fan speed

With this option selected, the indoor fan speed changes automatically according to the difference between the detected air temperature (RAT sensor) and the set point (SPT):

COOLING MODE

$2 \leq (\text{RAT} - \text{SPT})$: HIGH speed
 $1 \leq (\text{RAT} - \text{SPT}) < 2$: MEDIUM speed
 $(\text{RAT} - \text{SPT}) < 1$: LOW speed

HEATING MODE

$2 \leq (\text{SPT} - \text{RAT})$: HIGH speed
 $(\text{SPT} - \text{RAT}) < 2$: MEDIUM speed

NOTE

SPT = Set Point Temperature

7) Forced Mode

In this mode the system operates (COOLING or HEATING mode – fixed settings) or is switched off by means of the OPERATION button on the front panel. The operation modes can be selected pressing the button in a cyclic way (OFF ⇨ COOL ⇨ HEAT ⇨ OFF...). The settings are:

COOLING mode

SET POINT temperature = 25°C

FAN SPEED = HIGH

HEATING mode

SET POINT temperature = 21°C

FAN SPEED = HIGH

See also paragraph 15 for additional details.

8) Protection operations in Cool and Dry Mode

8.1 Freeze-up

This protection prevents ice formation on the indoor coil heat exchanger. The protection is activated by the indoor coil temperature (ICT sensor) and only after 6 minutes of compressor operation. This protection acts in 2 levels:

LEVEL 1

INDOOR FAN SPEED: ANY (as selected from remote controller)

COMPRESSOR: ON

OUTDOOR FAN: cycling (30 seconds ON ⇨ 30 seconds OFF).

DRAIN PUMP: operates according to paragraph 17

LEVEL 2

INDOOR FAN SPEED: ANY (as selected from remote controller)

COMPRESSOR: OFF for at least 6 minutes and until $ICT \geq 8^{\circ}\text{C}$

OUTDOOR FAN: OFF for at least 6 minutes and until $ICT \geq 8^{\circ}\text{C}$

DRAIN PUMP: always ON (stops when exiting the protection)

The system exit this protection routine when ICT temperature rises above 8°C.

9) Protection operations in Heat Mode

9.1 Cold draft

This feature prevents the supply of cold air forcing the indoor fan to a speed which cannot be changed by the user. As soon as the protection mode is exited speed can be changed manually through the remote controller. The protection acts in the following

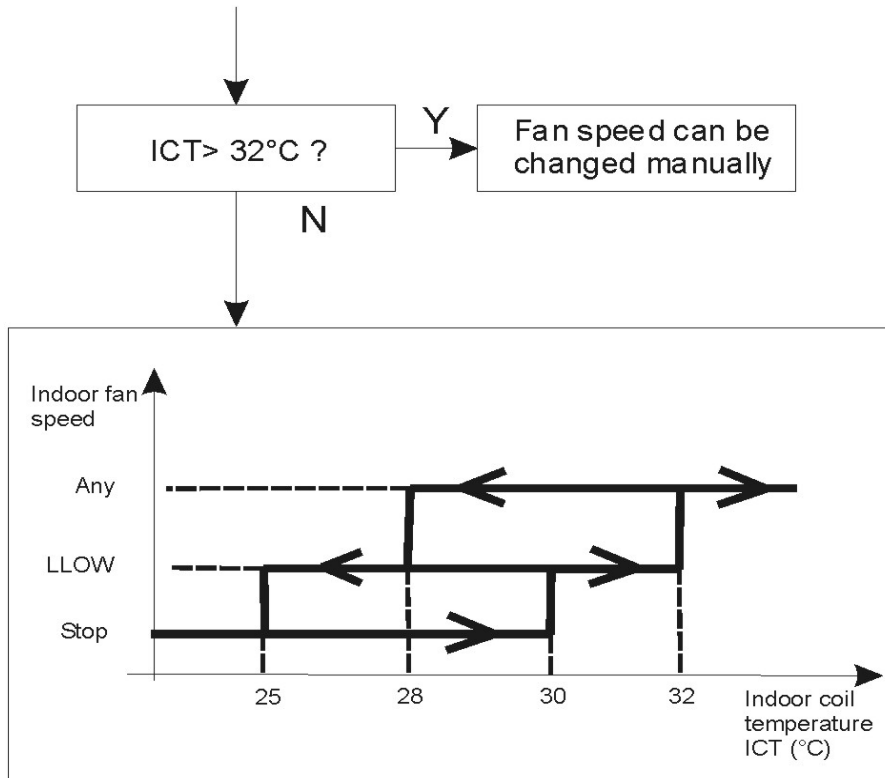

9.2 Defrost

The defrost process is controlled by a detection algorithm designed in order to maintain optimal utilization of the heat pump capacity especially during negative outdoor temperature conditions. During DEFROST OPERATION the main components operates according to the following chart:

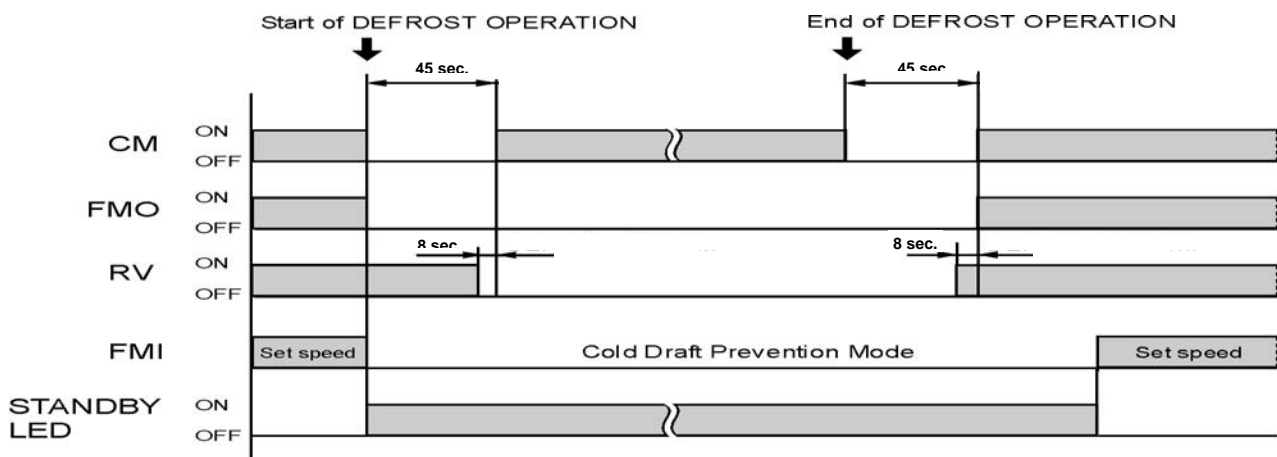

9.3 Overheat

This feature prevents the build up of high pressure in the indoor heat exchanger during heating operation

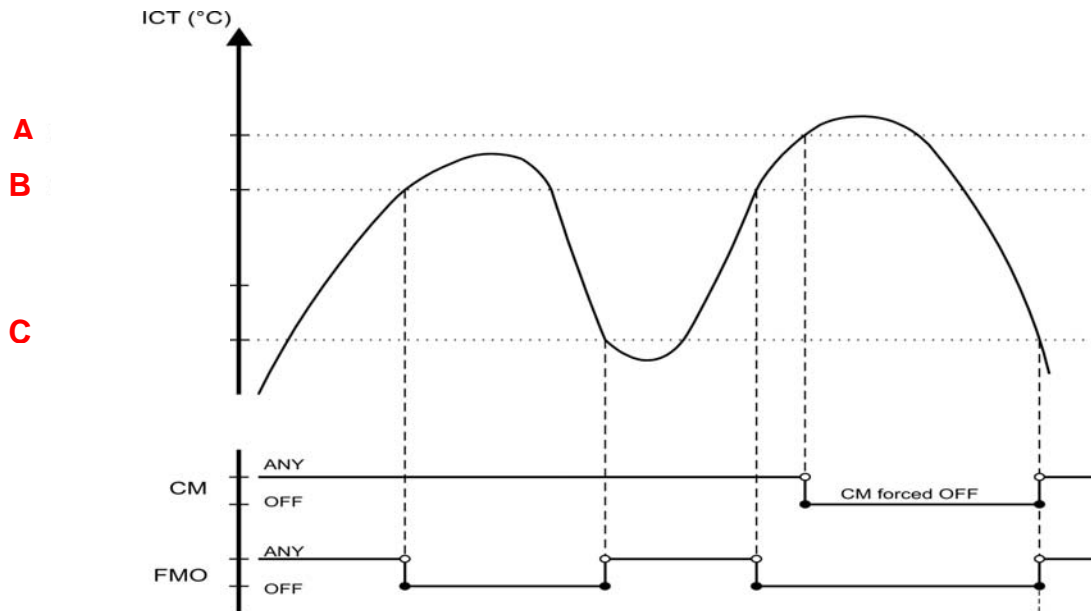

	237R
A (°C)	60
B (°C)	55
C (°C)	46

10) I FEEL Function

As standard configuration the air conditioner operates detecting the room temperature through the sensor equipped in the wireless remote controller (icon I FEEL shown on the display). This feature provides a personalised environment since the temperature can be detected where the remote controller is located. It is possible to de-activate this option pressing the I FEEL button on the remote controller. In this case the I FEEL icon is no longer displayed and room temperature is detected through the sensor included in the indoor unit.

11) NIGHT Function

When this function is active, room temperature changes automatically to compensate for body temperature variations while sleeping. After 10 hours of operation system switches automatically to OFF state. This mode of operation is available both in COOLING and HEATING mode.

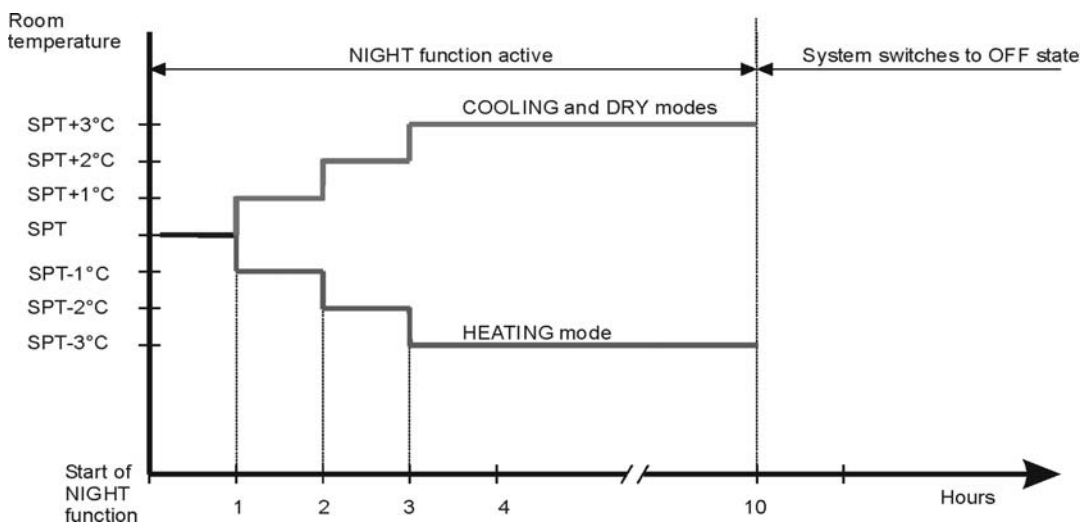

12) Diagnostic

With this feature it is possible to have a visual signal that a trouble is occurring.

This mode is always active and the signalling is made through the display board LEDs.

In case of no troubles the LEDs status follows its normal function.

NOTES

- The troubles are showed according a priority list that is in case of more than one trouble present, is always showed, at first, the one with the highest priority (1 ⇒ 2 ⇒ 3 etc).
- Sensor damaged means a situation where sensor is short-circuited or opened.
- In case of damaged sensors, the system (CM, FMO, FMI etc), if in OFF state, does not start.
- WRONG MODE SELECTED means a situation where the operating mode chosen with remote controller does not comply with the one allowed by jumpers settings.

Priority	TROUBLE	LEDS status			Effects
		LD1(stby)	LD2(opr)	LD3(timer)	
1	RAT damaged	F	O	O	System does not operate
2	ICT damaged	F	F	O	
3	WRONG MODE SELECTED	F	F	F	
4	Water level alarm	O	F	O	See paragraph 17. DRAIN PUMP

O = LED off

F = LED blinking

13) JUMPERS CONFIGURATION

Jumpers are located on the indoor PCB near the MODE button.

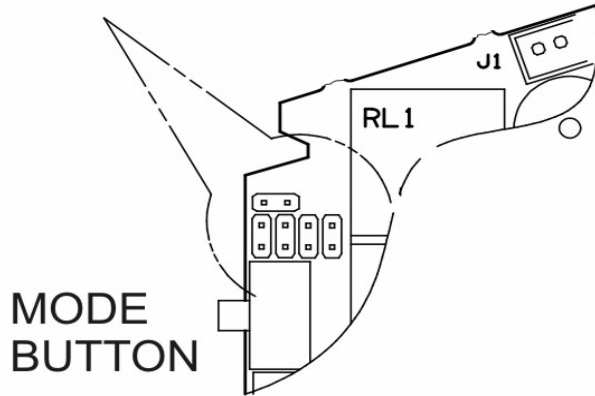
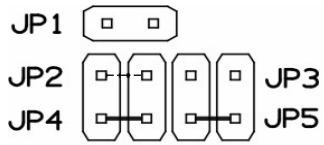

Unit is shipped with jumpers set according to the following table:

JUMPER	STATUS	
JP1	open	
JP2	open for H/P models - closed for other versions	
JP3	open	
JP4	closed	
JP5	closed	

14) CONTACTS FOR BUILDING AUTOMATION

INPUT CONTACT (J4 - green) - AVAILABLE ONLY IF "BOILER CONNECTION KIT" IS NOT INSTALLED

The status of this input affects system operation according to the following:

Contact OPEN : system does not operate (always OFF) – inputs from wireless remote controller are not processed

Contact CLOSED: system operates in the normal way according to the inputs coming from wireless remote controller

OUTPUT CONTACT (J12)

This connector is directly tied to the contact (normally open) of a power relay which activates every time the following alarm condition occur:

- RAT damaged
- ICT damaged

In this case when alarm happens, on poles 1 and 3 of J12 connector, 220 VAC-50Hz are available.

Max electrical load: **1A- 240VAC**

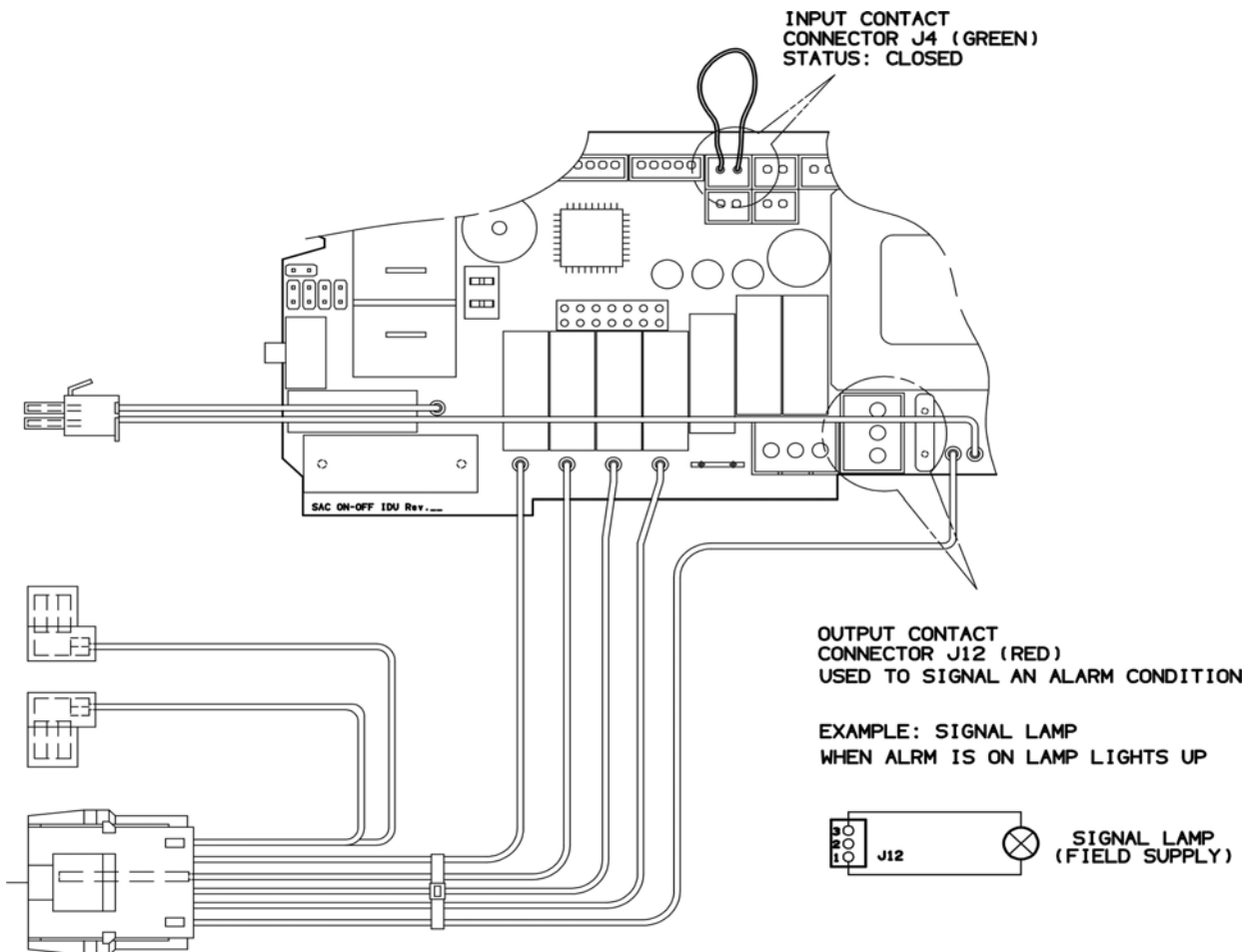

15) MAINTENANCE

Changing the Address of the Air Conditioner

In case of more than one air conditioner operating in the same room, it may be necessary to assign an address to each unit in order to avoid operation conflicts. Address is set acting on the dip-switches located on the indoor PCB and on the remote controller. The PCB settings must match the corresponding ones on the wireless remote controller

How to change address of the air conditioner

Dip switch is located on the indoor PCB near the buzzer.
Set the PCB to the address desired

UNIT ADDRESS	SETTINGS	
	SW1	SW2
1	off	off
2	off	on
3	on	off
4	on	on

As default switches SW1 and SW2 are in off status (PCB factory state).

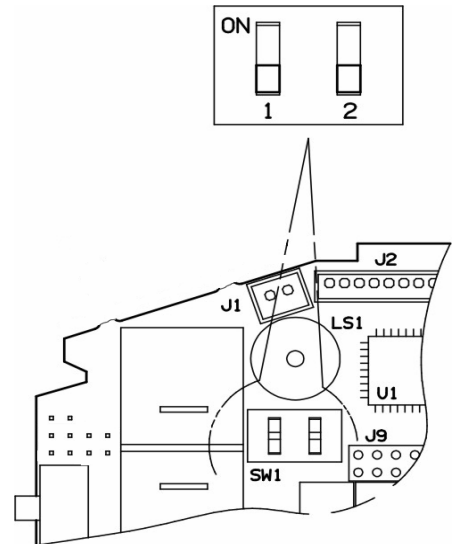

How to change address on Remote Control Unit

Dip switch is located on the battery compartment.

- 1) Pull out the door and remove the batteries.
- 2) Set the switch SW1 and SW2 according to the indoor PCB settings (do not act on SW3 and SW4)
- 3) Insert the batteries and pull on the door

As default switches SW1 and SW2 are in off status (remote controller factory state).

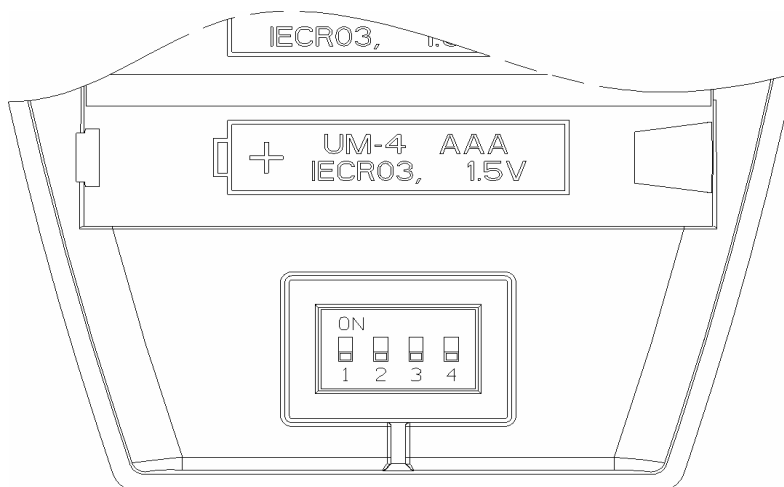

16) Manual Unit Control and LED indicators

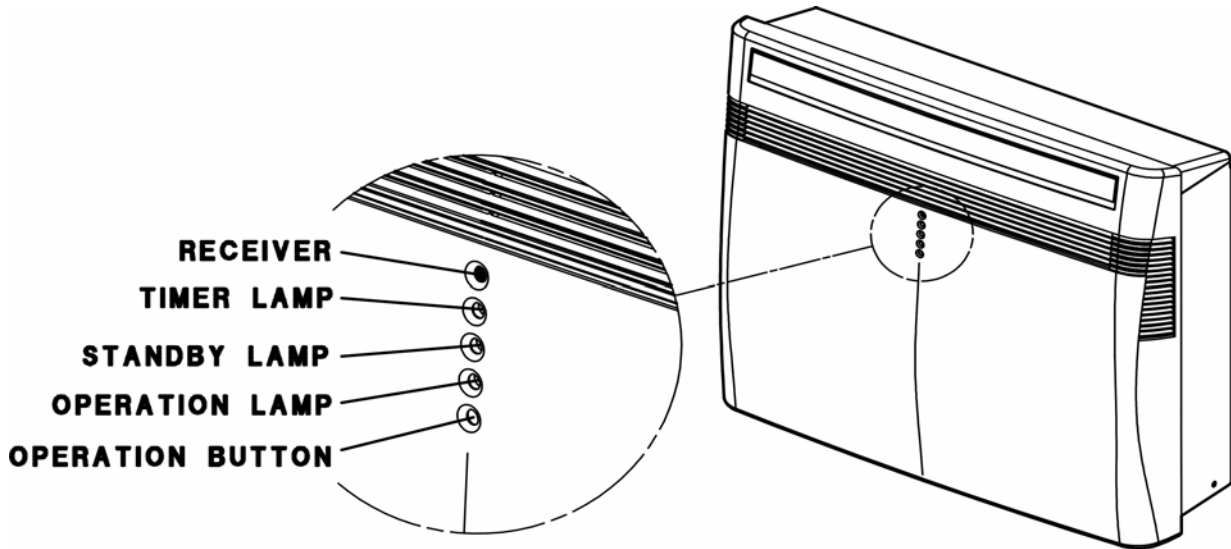

The push button switch and the LED indicators on display panel let the user to control the unit operation without a R/C (Remote Controller). Their operations are provided below.

Push Button Switch :

OPERATION BUTTON	<p>Use to cycle the operation mode of the A/C unit among COOL, HEAT and OFF modes, without using the R/C.</p> <p>Every time this switch is pressed, the next operation mode is selected, in order:</p> <ul style="list-style-type: none"> - Off => Cool mode => Heat mode => Off => ... (for heat pump model) - Off => Cool mode => Off => ... (for cooling only model) - The A/C will start in High fan speed. <p>The temperature setting is 25°C for cooling and 21°C for heating mode.</p>
---------------------	---

WARNING:

the OFF position does not disconnect the power. Use the main power switch to turn off power completely.

Led indicators :

TIMER LAMP	1. Lights up during Timer operation.
STANDBY LAMP	1. Lights up when the Air conditioner is connected to power and ready to receive the Remote Control command. 2. Blinks continuously in case of any thermistor failure.
OPERATION LAMP	1. Lights up in Operation mode (Note: OFF in standby mode). 2. Blinks for 0,5 sec., to announce that a R/C infrared signal has been received and stored. 3. Blinks continuously in case of any thermistor failure. 4. Blinks continuously in case of FS (Float Switch) trips for high water level.
TIMER+STBY+OPR LAMP	1. Blinks continuously in case of wrong mode selected.

Recovery from Power Failure

Last unit settings (SPT, operation mode, louver settings, etc) are saved in the EEPROM in the unit. In case of power failure, these settings are restored automatically.

17) Outdoor fan operation

Outdoor fan speed change from HI to Low according to outdoor air temperature as indicated on the chart below.

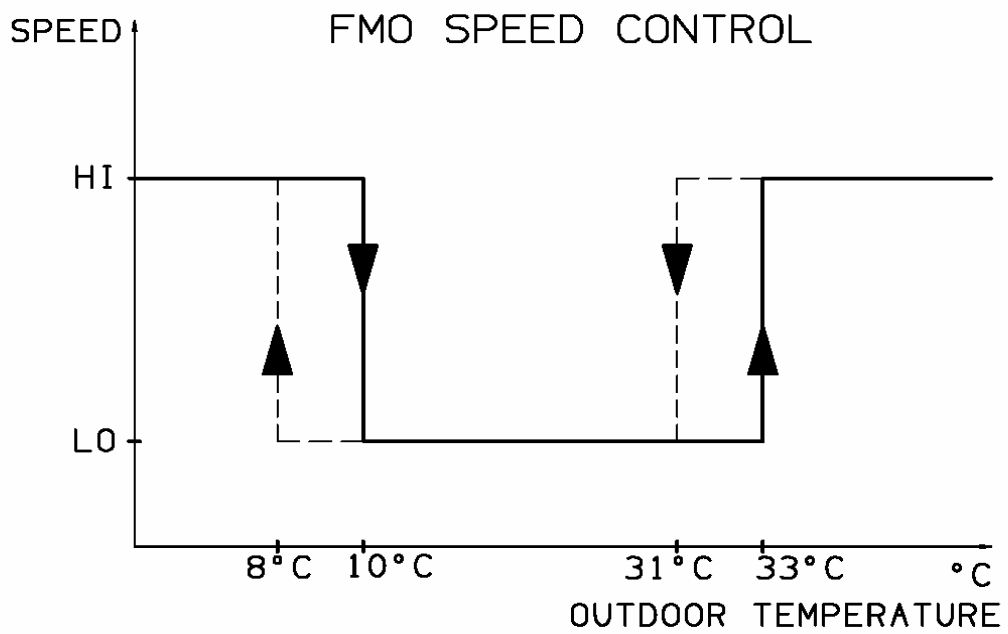

18) DRAIN PUMP

Pump operates when the unit is running in COOLING and DRY modes.

The level detection is done through a float switch connected at the input FS (closed under normal condition, and opened when water overflow). System operation is according to the following chart:

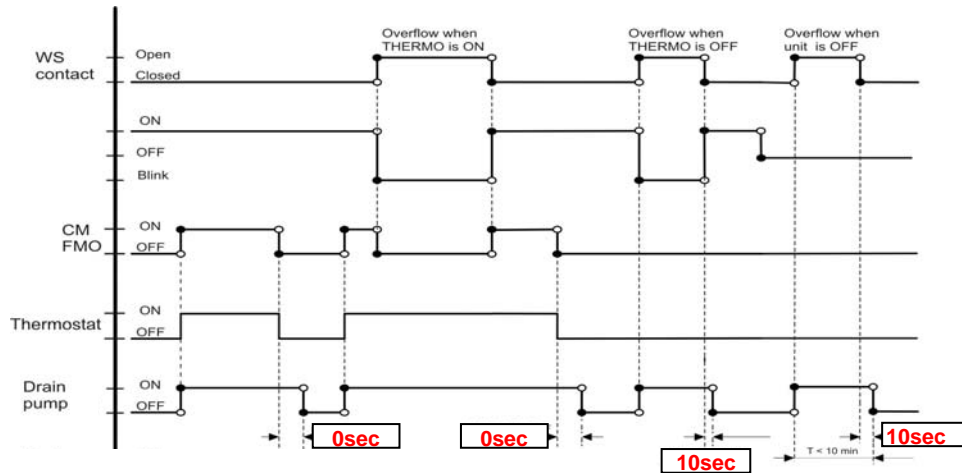

1- Cooling only model

REVE 247C

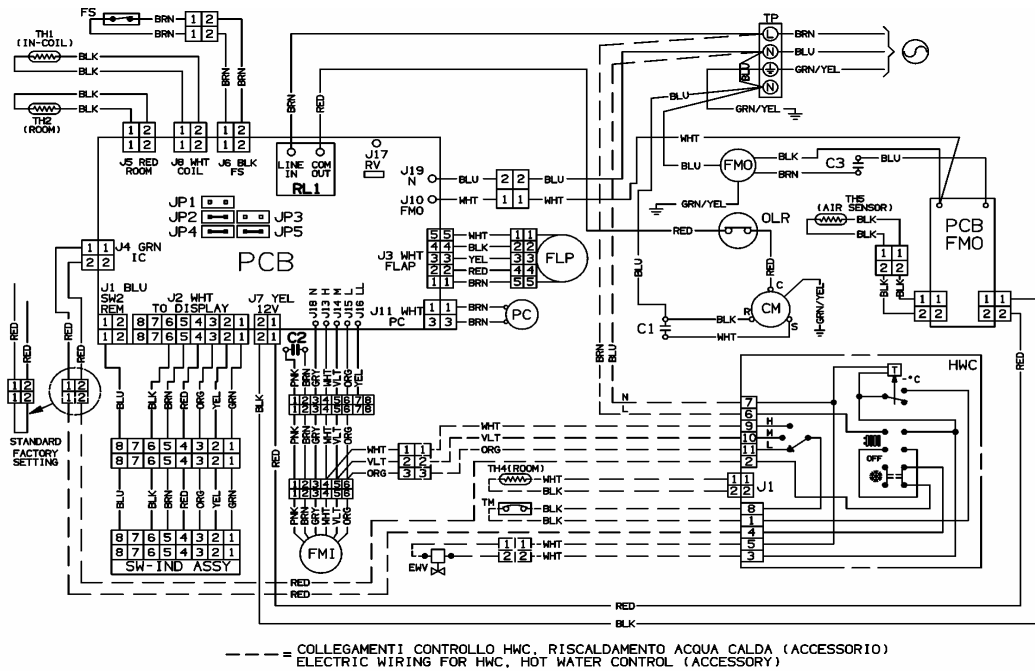

--- = COLLEGAMENTI CONTROLLO HWC, RISCALDAMENTO ACQUA CALDA (ACCESSORIO)
 --- = ELECTRIC WIRING FOR HWC, HOT WATER CONTROL (ACCESSORY)

LEGENDA

PCB	Controller	SW-IND-ASSY	Indicator assy
FMI	Indoor fan motor	TH1-2-3-4-5	Thermistor
CM	Compressor motor	TP	Terminal plate
OLR	Overload relay	HWC	Hot water control
FMO	Outdoor fan motor	TM	Limit water thermostat
C1-2-3	Capacitor	EWV	Water electric valve
PC	Condensate pump motor	FS	Float switch
20S	4-way valve	FLP	Flap motor
PCB/FMO	Controller Outdoor fan motor	F1	Fuse

REVE 237R

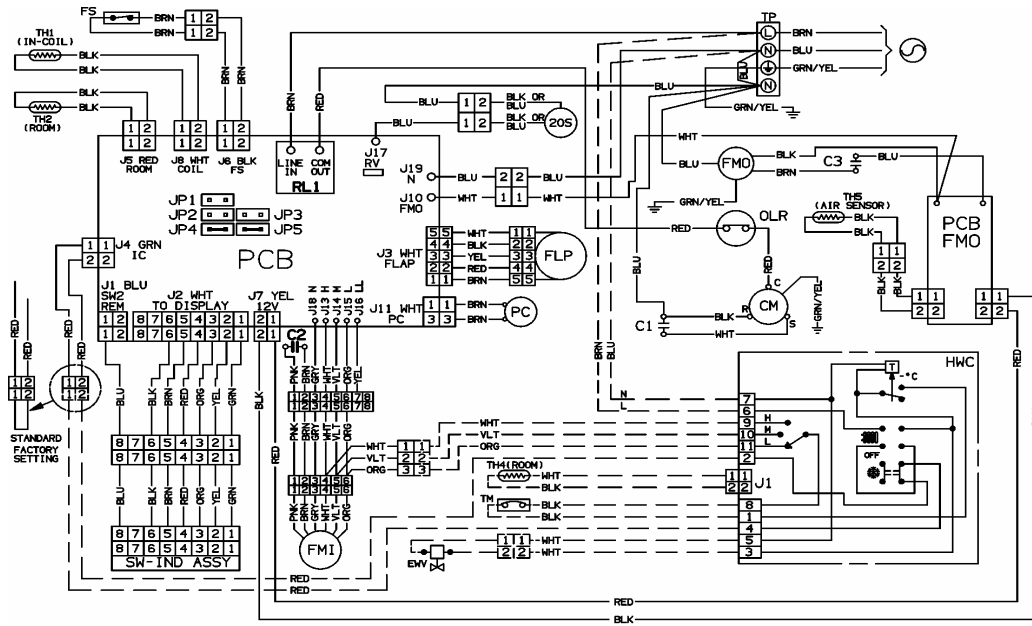

--- = COLLEGAMENTI CONTROLLO HWC, RISCALDAMENTO ACQUA CALDA (ACCESSORIO)
 ELECTRIC WIRING FOR HWC, HOT WATER CONTROL (ACCESSORY)

LEGENDA

PCB	Controller	SW-IND-ASSY	Indicator assy
FMI	Indoor fan motor	TH1-2-3-4-5	Thermistor
CM	Compressor motor	TP	Terminal plate
OLR	Overload relay	HWC	Hot water control
FMO	Outdoor fan motor	TM	Limit water thermostat
C1-2-3	Capacitor	EWV	Water electric valve
PC	Condensate pump motor	FS	Float switch
20S	4-way valve	FLP	Flap motor
PCB/FMO	Controller Outdoor fan motor	F1	Fuse

H TROUBLESHOOTING

CHECK BEFORE AND AFTER «TROUBLESHOOTING»

(A) Check power supply wiring.

- Check the power supply wires are correctly connected.

(B) Check power supply.

- Check that voltage is in specified range ($\pm 10\%$ of the rating).
- Check that power is being supplied.

• **WARNING:** If the following troubleshooting must be done with power supplied, be careful not to touch any uninsulated live part that can cause ELECTRIC SHOCK.

A CIRCUIT BREAKER TRIPS OR FUSE BLOWS.

- When circuit breaker is set to ON, it trips in a few moments. Resetting is not possible.
- Measure insulation resistance. There is a possibility of ground fault.
If resistance value is 1 Mohm or less, insulation is defective.

B CIRCUIT BREAKER TRIPS IN SEVERAL MINUTES AFTER TURNING AIR CONDITIONER ON.

- 1 • There is the possibility of short circuit.

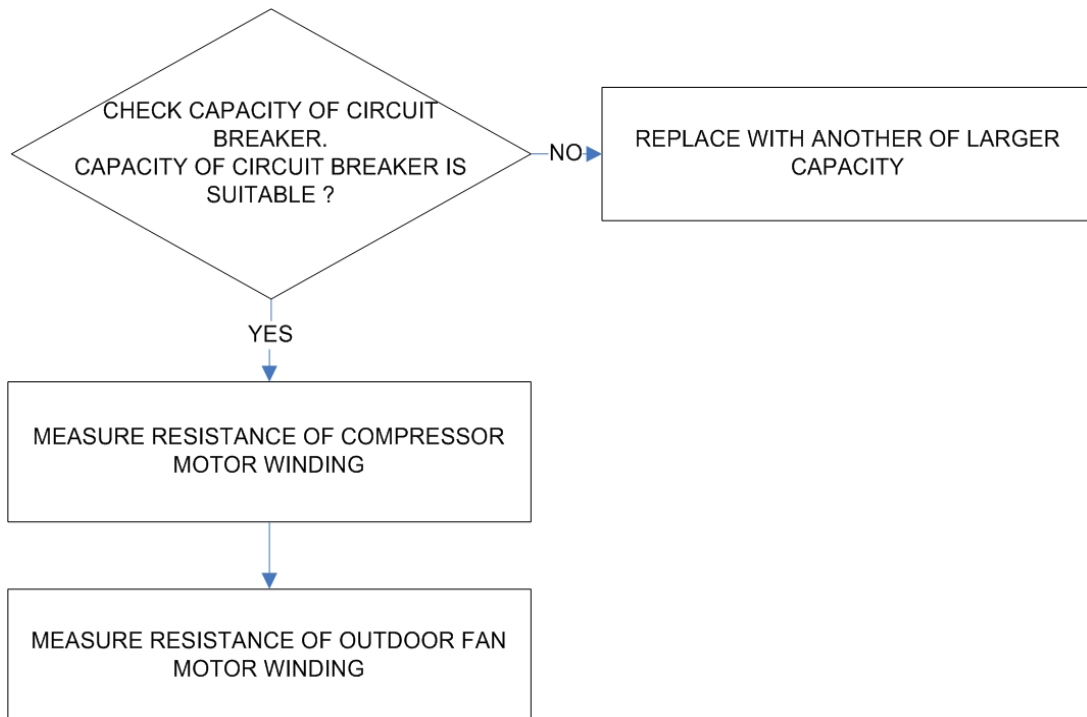

2 • The unit does not run.

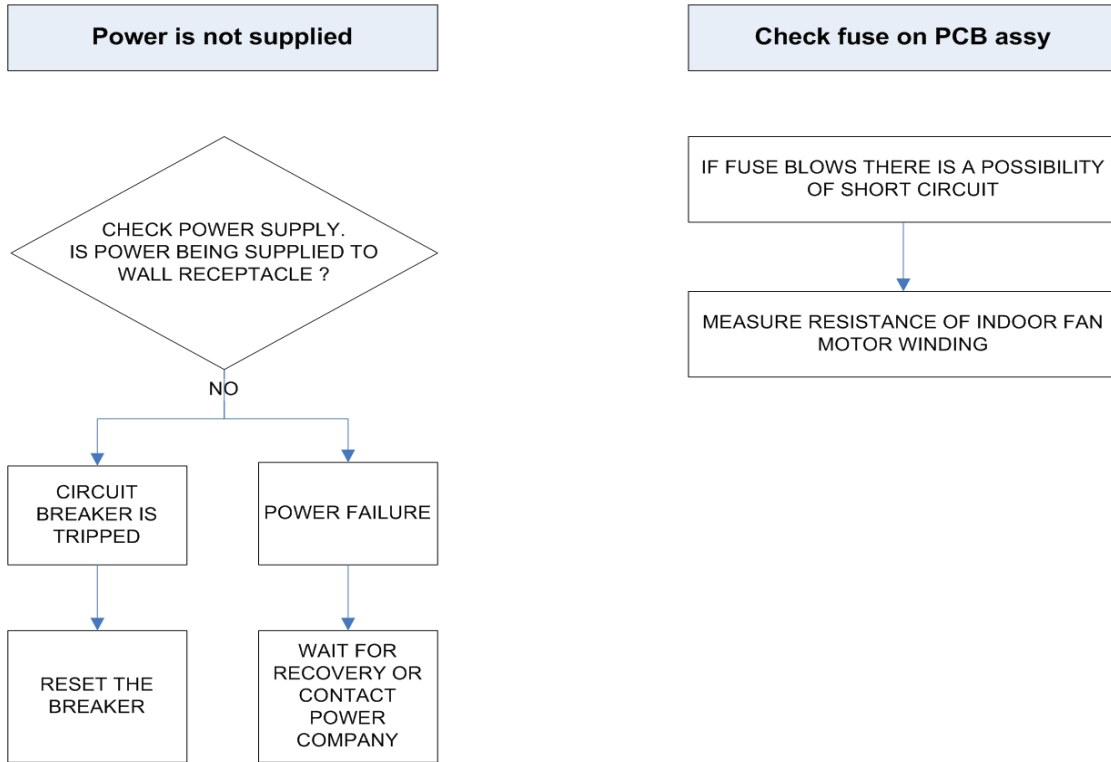

WATER LEVEL ALARM - OPERATION LAMP IS BLINKING.

Malfunctioning of the condensate drainanege system.

NOTE: In case of emergency the air conditioner can work by drainage the condensate from the little pipe into a rather short container. Extract the little pipe and remove the cap.

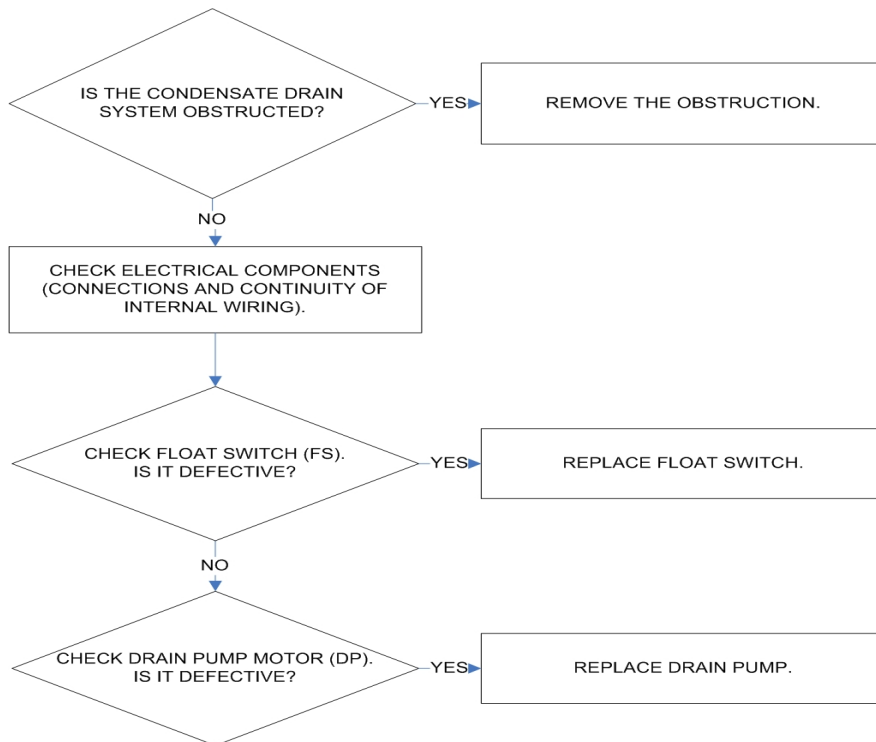

D UNIT AND COMPRESSOR DO NOT RUN.

The unit does not run when air conditioner is in the following conditions:

- When the room temperature is below the setting temperature.
- During the protection modes.

CHECK PCB

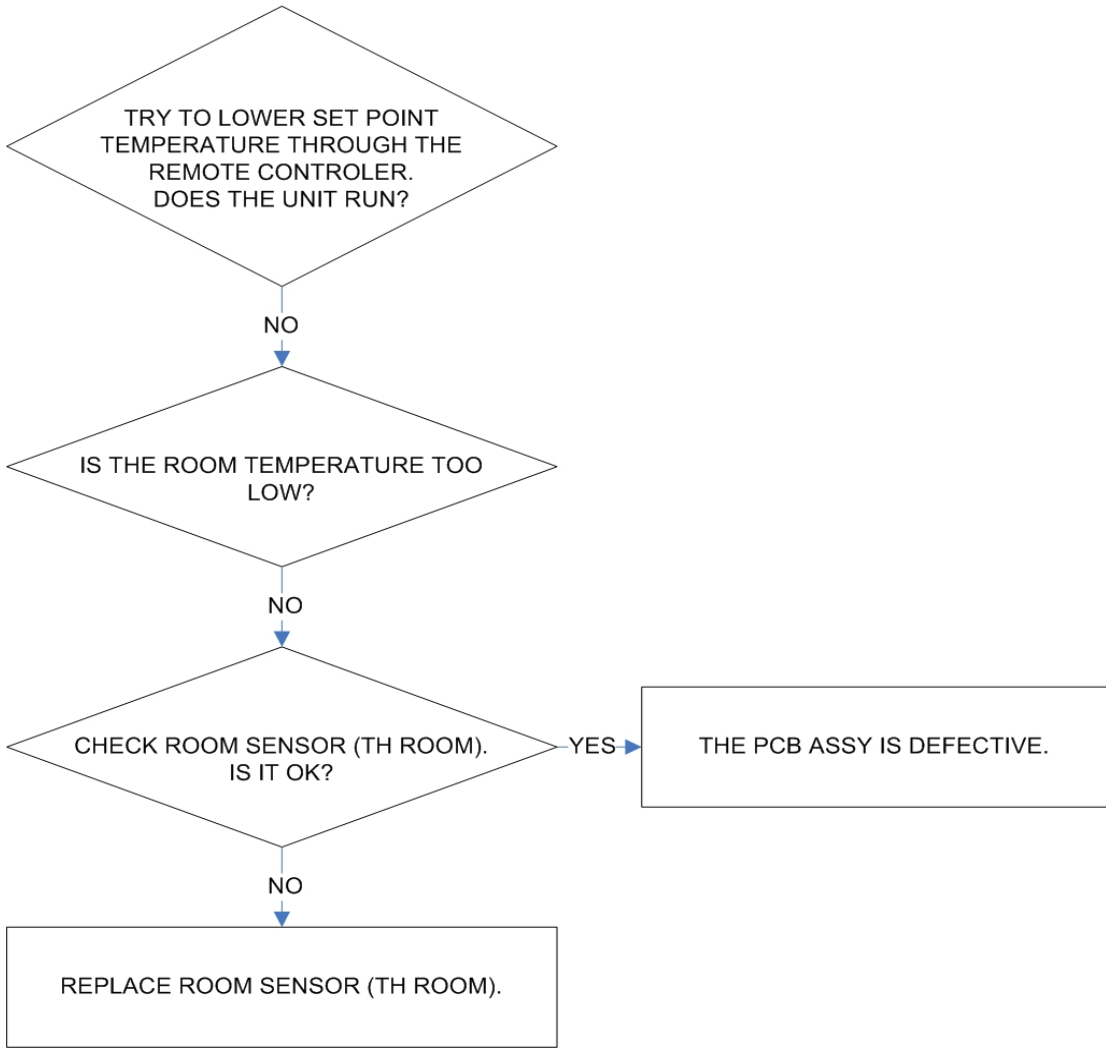

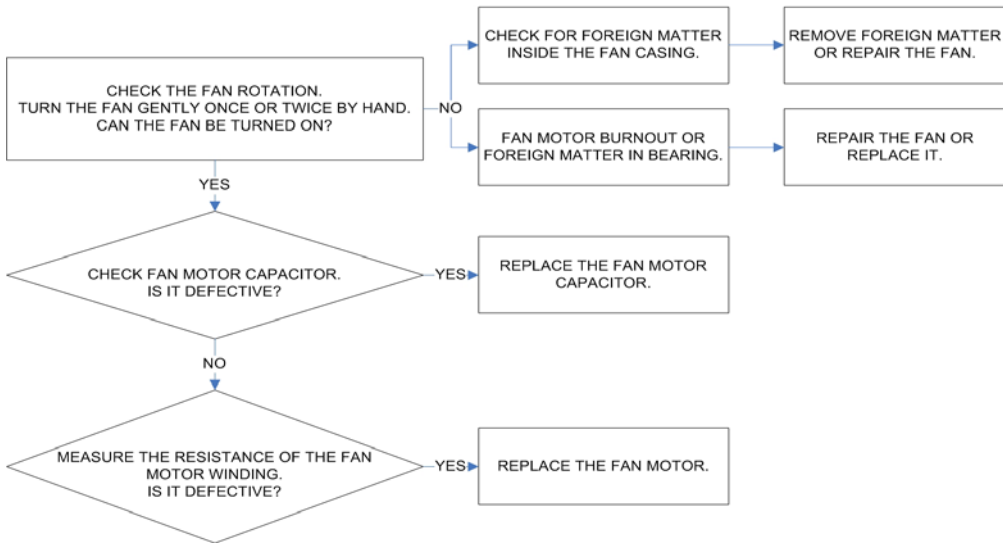
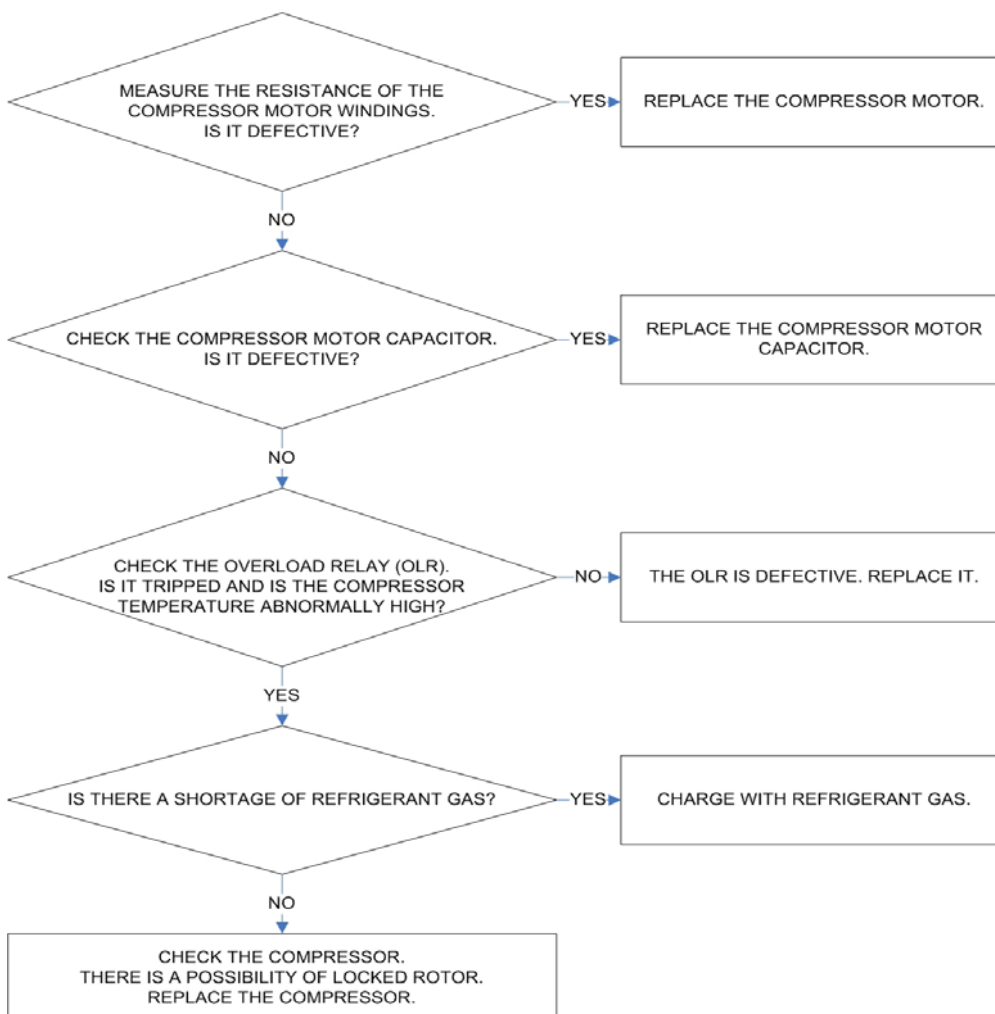
E**SOME PARTS OF THE AIR CONDITIONER DO NOT OPERATE.****INDOOR / OUTDOOR FAN DOES NOT RUN****COMPRESSOR MOTOR DOES NOT RUN**

F

AIR CONDITIONER OPERATES, BUT ABNORMALITIES ARE OBSERVED.

OPERATION DOES NOT SWITCH FROM HEAT TO COOL AND/OR FROM COOL TO HEAT

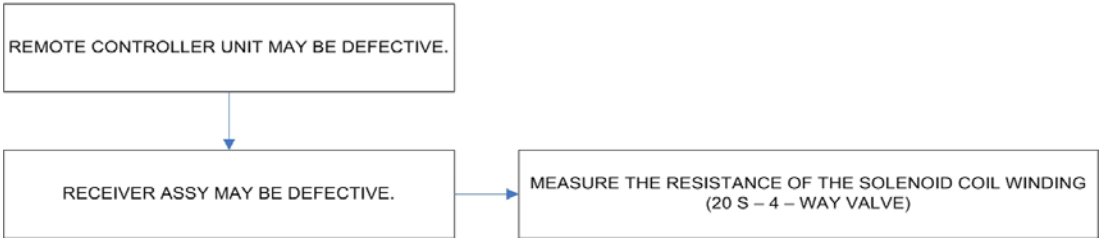

CHECK "MODE BUTTON" ON THE UNIT

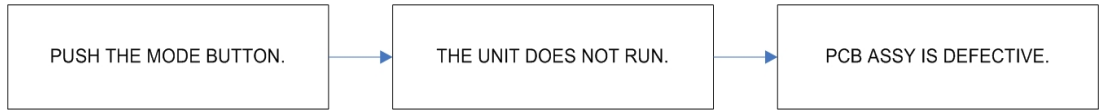

CHECK REMOTE CONTROL UNIT

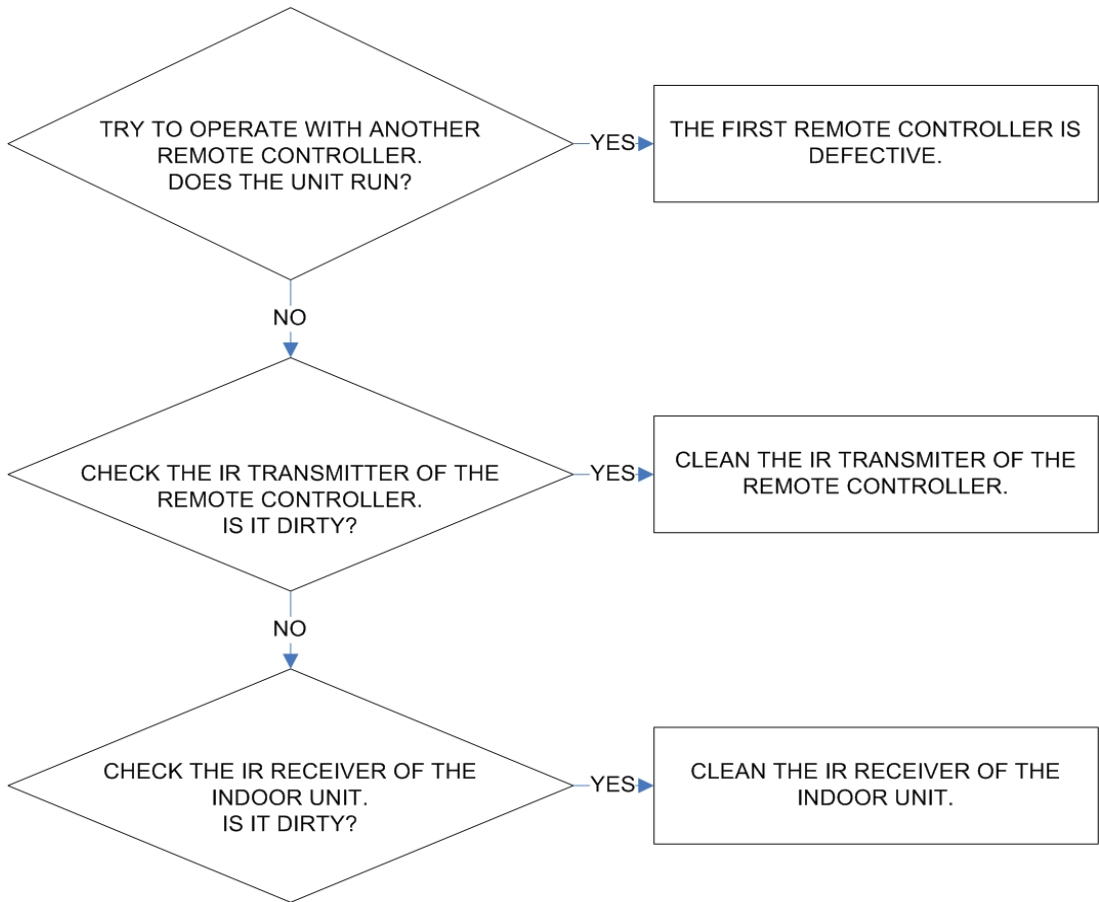

CHECK FUSE ON PCB ASSY IN THE UNIT

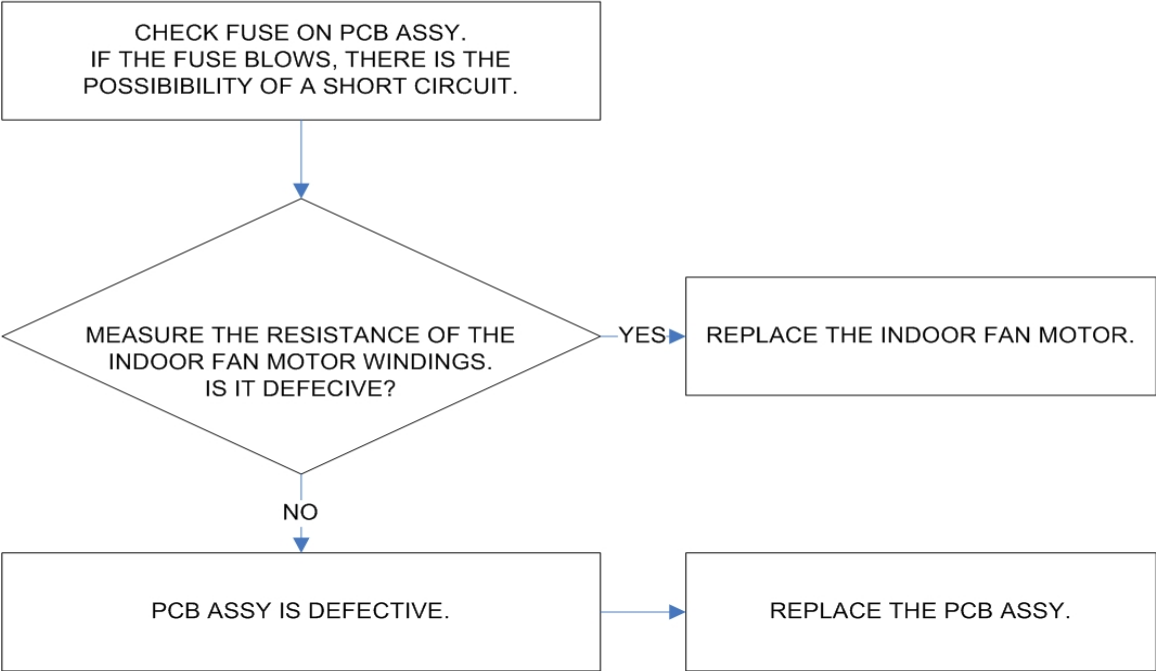

CHECK SETTING TEMPERATURE

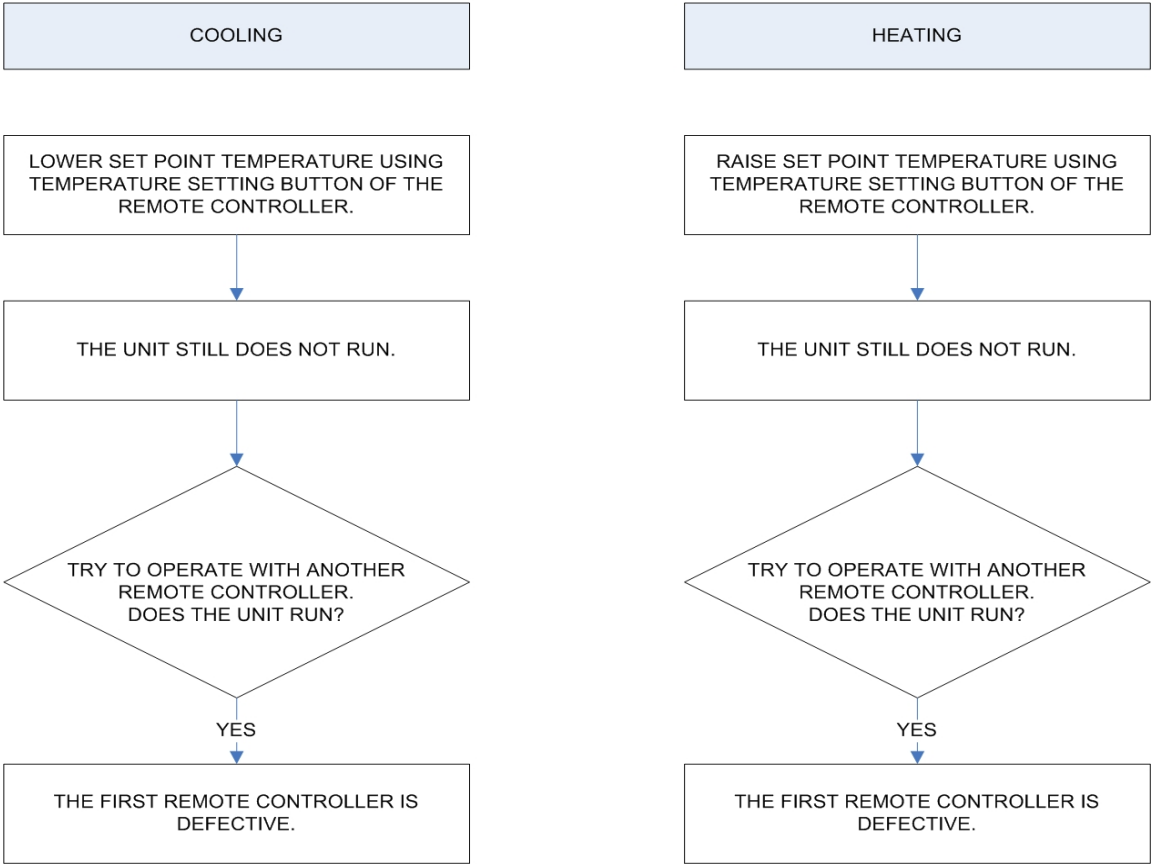

G POOR COOLING OR HEATING.

"I FEEL" IS SELECTED



FAN SPEED

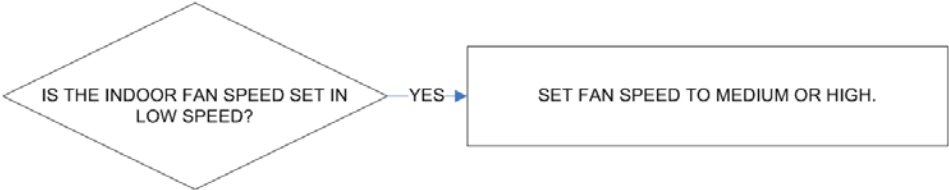

COOLING / HEATING LOAD

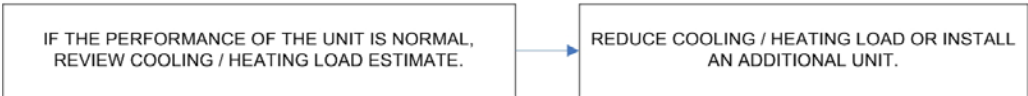

"I FEEL" IS NOT SELECTED

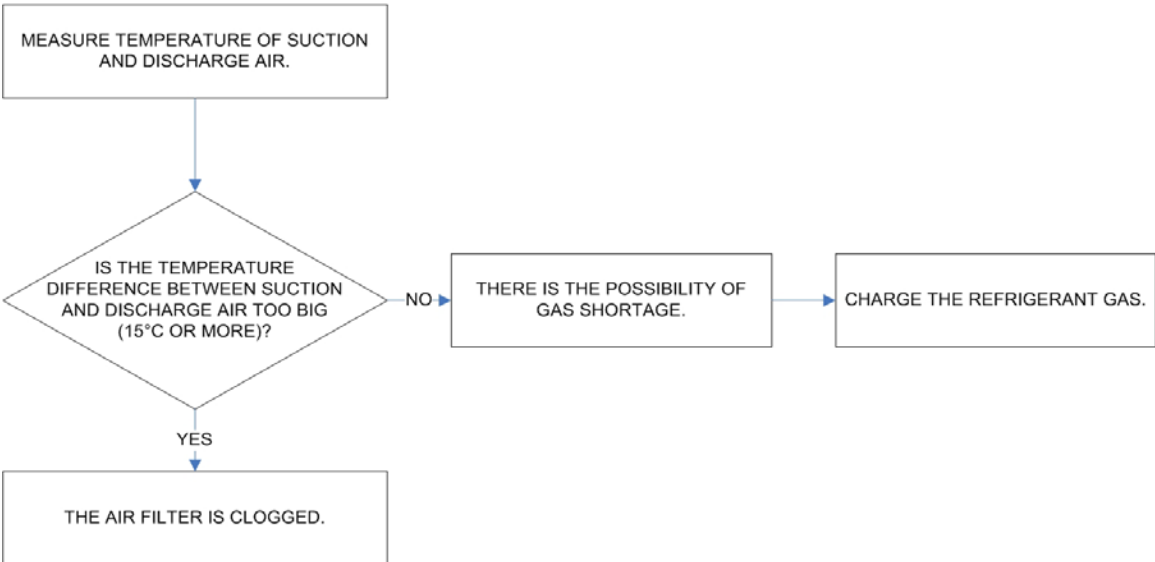

H EXCESSIVE COOLING OR HEATING.

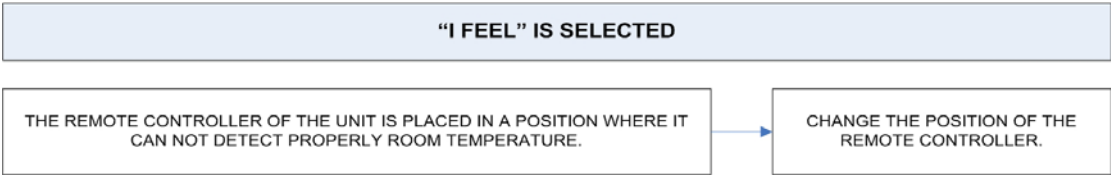

I A SENSOR IS DEFECTIVE.

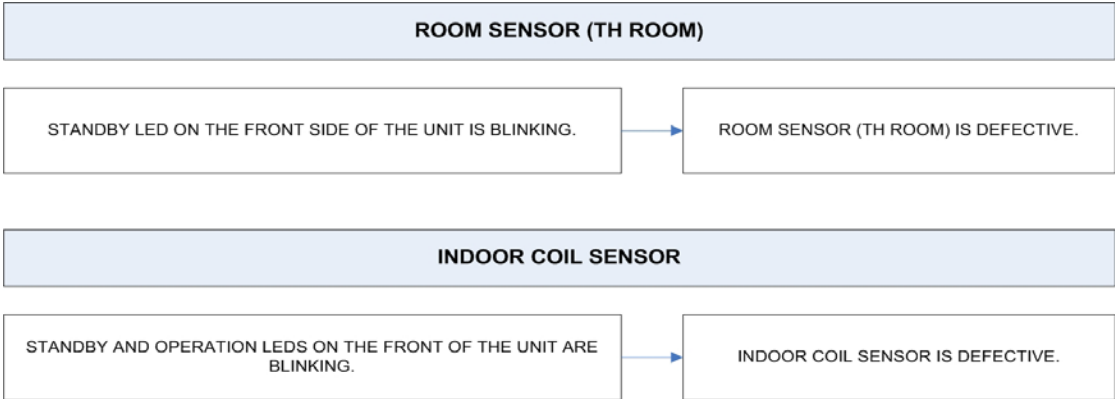

I**REFRIGERANT CHARGE**

	REVE 247C	REVE 237R
REFRIGERANT CHARGE R410A	600 g	520 g

IMPORTANT

In order to recharge the unit use the high-pressure side gate.

Preliminary operation after refrigerant charge

L CHECKING ELECTRICAL COMPONENTS

1) Measurement of Insulation Resistance

- The insulation is in good condition if the resistance exceeds 1M Ω m.

a) Power Supply Wires

Clamp the earthed wire of the power supply wires with the lead clip of the insulation resistance tester and measure the resistance by placing a probe on either of the power wires (Fig. 1).

Then measure the resistance between the earthed wire and the other power wires (Fig. 1).

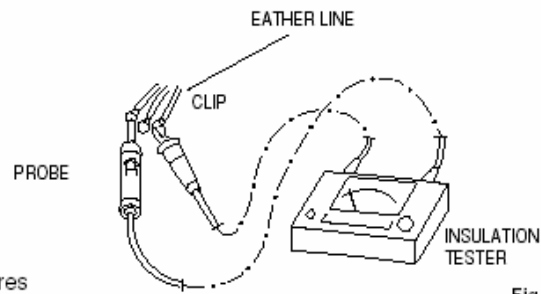

Fig. 1

b) Unit

Clamp an aluminium plate fin or copper tube with the lead clip of the insulation resistance tester and measure the resistance by placing a probe on N terminal, and then on L terminal the terminal plate (Fig. 2).

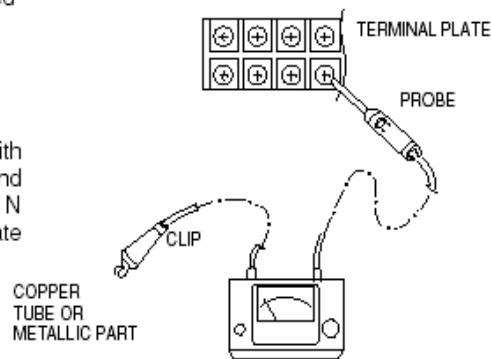

Fig. 2

c) Measurement of Insulation Resistance for Electrical Parts

Disconnect the lead wires of the disired electric part from terminal plate, PCB Ass'y, capacitor, etc. Similarly disconnect the connector. Then measure the insuration resistance. (Fig. 1 to 4). Refer to Electric Wiring Diagram

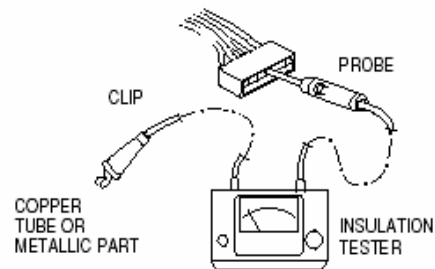

Fig. 3

NOTE

- If the probe cannot enter the poles because the hole is too narrow then use a probe with a thinner pin.

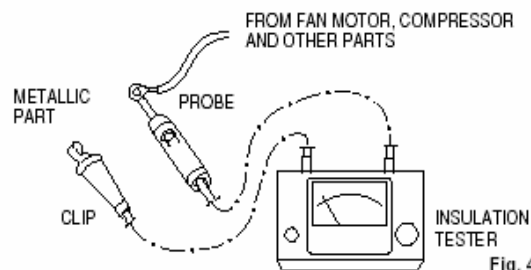

Fig. 4

2) Checking Continuity of Fuse on PCB Ass'y

- Remove PCB Ass'y from electrical component box. (Fig. 5).
- Then pull out the fuse from PCB Ass'y.

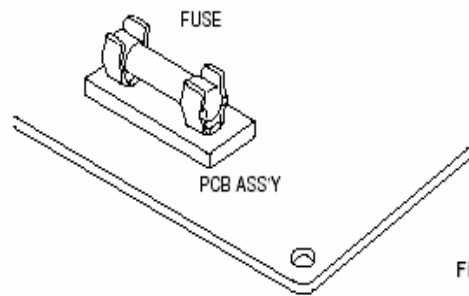

Fig. 5

- Check continuity of fuse by the multimeter (Fig. 6).

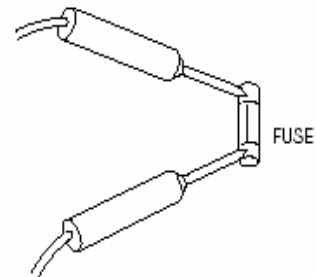

Fig. 6

3) Checking Motor Capacitor

- Remove the lead wires from the capacitor terminals, and then place a probe on the capacitor terminals as shown in Fig. 7. Observe the deflection of the pointer, setting the resistance measuring range of the multimeter to the maximum value. The capacitor is "good" if the pointer bounces to a great extent and the gradually returns to its original position. The range of deflection and deflection time differ according to capacity of the capacitor.

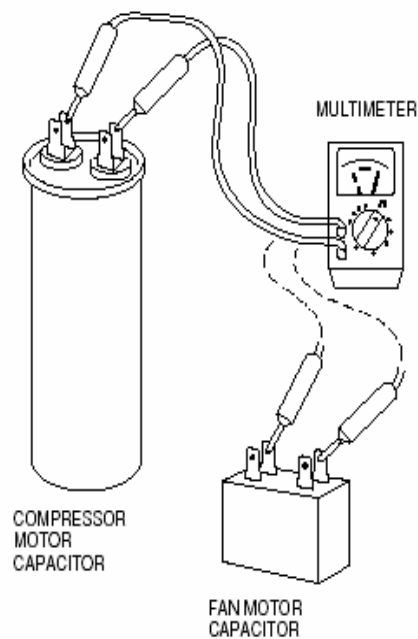
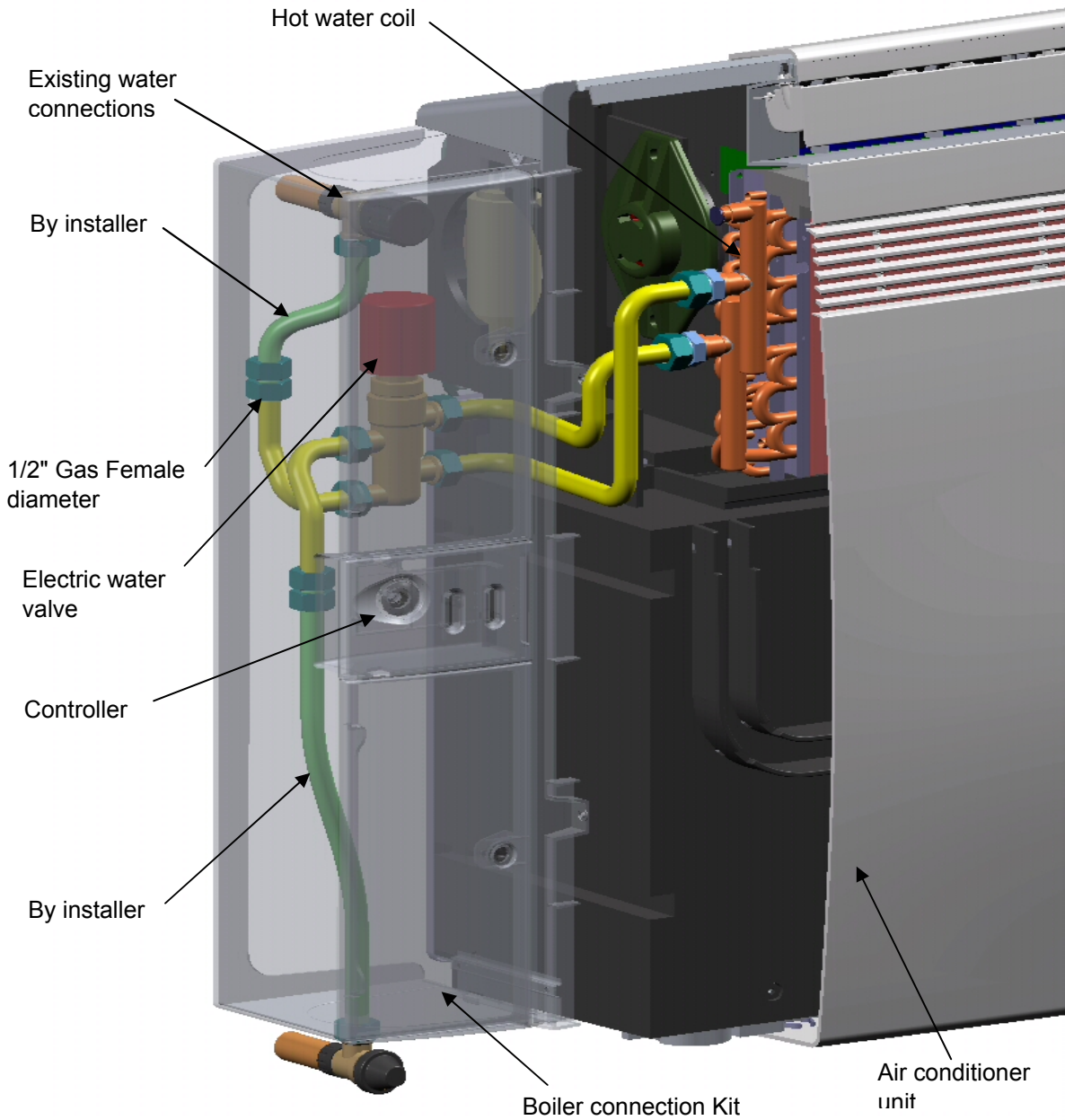

Fig. 7

Typical installation



1) SPECIFICATIONS

Power source		230 V ~ 50 Hz	
Capacity at standard conditions	W	2100	
Power input	W	27	
Fan speed		3 (Hi - Me - Lo)	
Standard conditions:	Ambient temp.	°C	20
	Fan speed		High
	Inlet water temp.	°C	70
	ΔT water	K	10
Water coil only	ΔP water	kPa	0,7 (70 mmH2O)
	water flow	l/h	155 (2,6 l/min.)
Valve and tubes including	ΔP water	kPa	2,9 (290 mmH2O)
	water flow	l/h	190 (3,1 l/min.)

OPERATING LIMITS

Max temperature inlet hot water	°C	70°C
Max pressure	bar	10

2) PERFORMANCE CHARTS

Performance on different conditions

Capacity reduction factor : **High speed = 1** ; Med. speed = 0,96 ; Low speed = 0,93

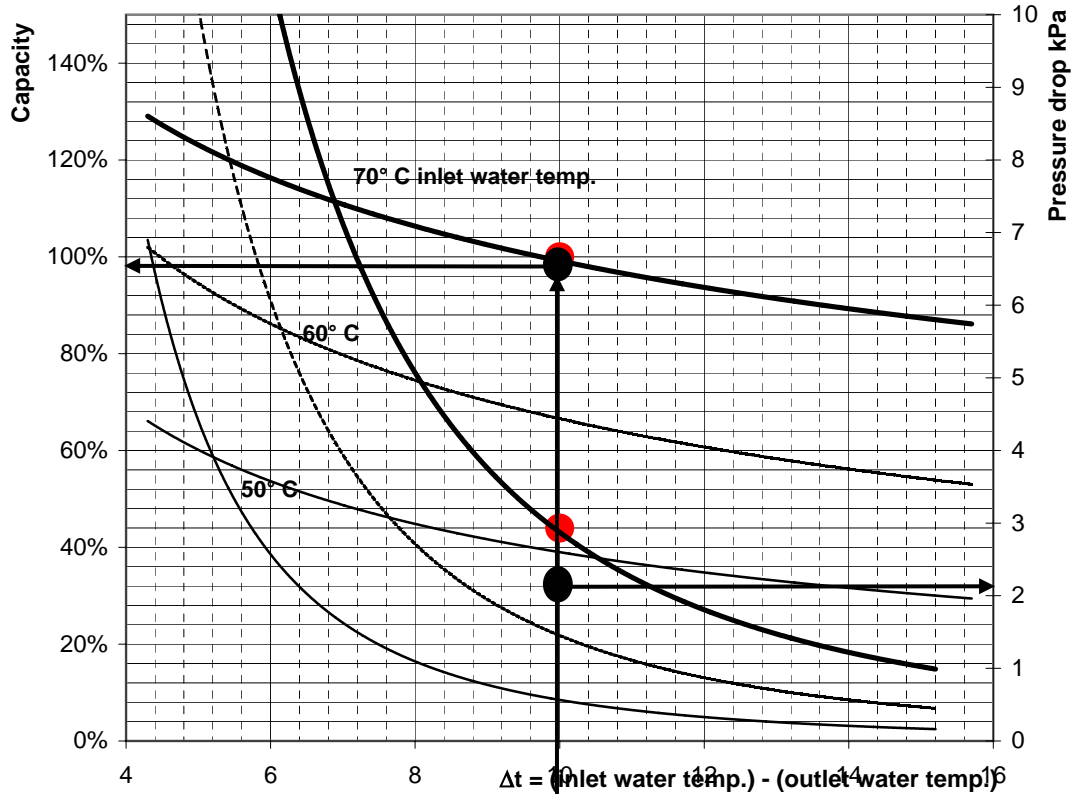

WATER FLOW AND PRESSURE DROP – (3 WAY VALVE AND PIPE INCLUDING)

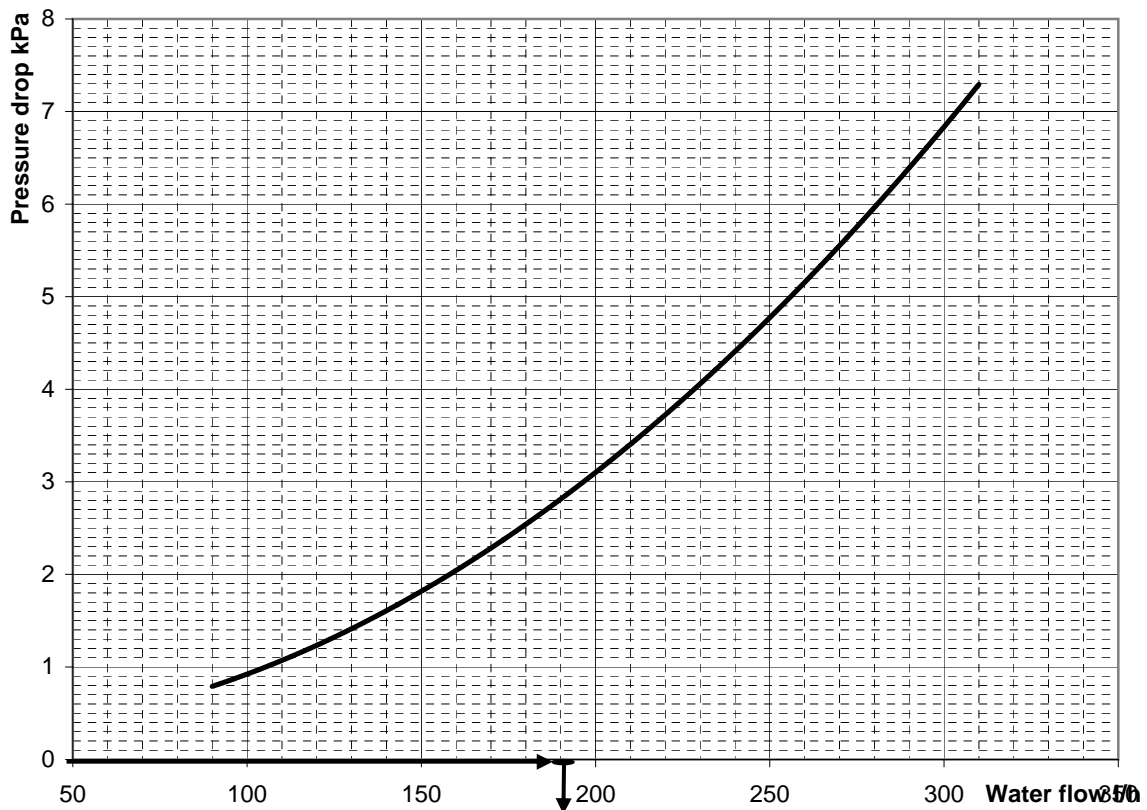

3) COMPONENT SPECIFICATIONS (Boiler connection kit)

CONTROLLER (HWC)		
Type		000TSA
Controls		Manual
Thermostat	Setting	6°C ±1°C ÷ 30°C ±1°C
	Differential	1K
THERMISTOR (ROOM SENSOR) TH4		
Type		STLNGY050
Resistance (at 25° C)	kΩ	4,7 ±2%
as alternative CONTROLLER (HWC)		
Type		078564-00
Controls		Manual
Thermostat	Setting	6°C ±1°C ÷ 30°C ±1°C
	Differential	1K
THERMISTOR (ROOM SENSOR) TH4		
Type		77798
Resistance (at 25° C)	kΩ	6,8 ±2%
LIMIT WATER THERMOSTAT (TM)		
Electrical rating		10(1,6) A - 250Vac
Control		Autoreset
setting		Open : 31°C ±3°C - Close: 42°C±4°C
Differential		11K
WATER ELECTRIC VALVE (EWV)		
Electric Thermal Actuator	Type	VA-7040-23
Supply voltage		230VAC ± 15%
Power consumption:	Continuous	2,5 W
	Start-up	36 W (150 mA) max
Nominal force		125 N
Nominal stroke		4,5 mm
Full stroke time at 50°C	Actuator stem	extends : 60 sec
	Actuator stem	retract : 10 min
3-way Forged brass valve	Type	VG-5510EC
Body Type		3-way NO bypass
Threaded Male Connection		1/2" Gas
Close-Off Pressure	kPa	100
Water HEAT EXCHANGER COIL		
Coil	Type	Aluminium plate fin / Copper tube
Rows		1
Fin pitch	mm	2,0
Face area	m ²	0,102
Threaded Male Connection		1/2" Gas

4) HYDRAULIC CONNECTIONS AND VALVES

- ① HOT WATER COIL
- ② 1/2" GAS CONTROL VALVE
- ③ 1/2" GAS HOLDER
- ④ 1/2" GAS WATER ELECTRIC VALVE

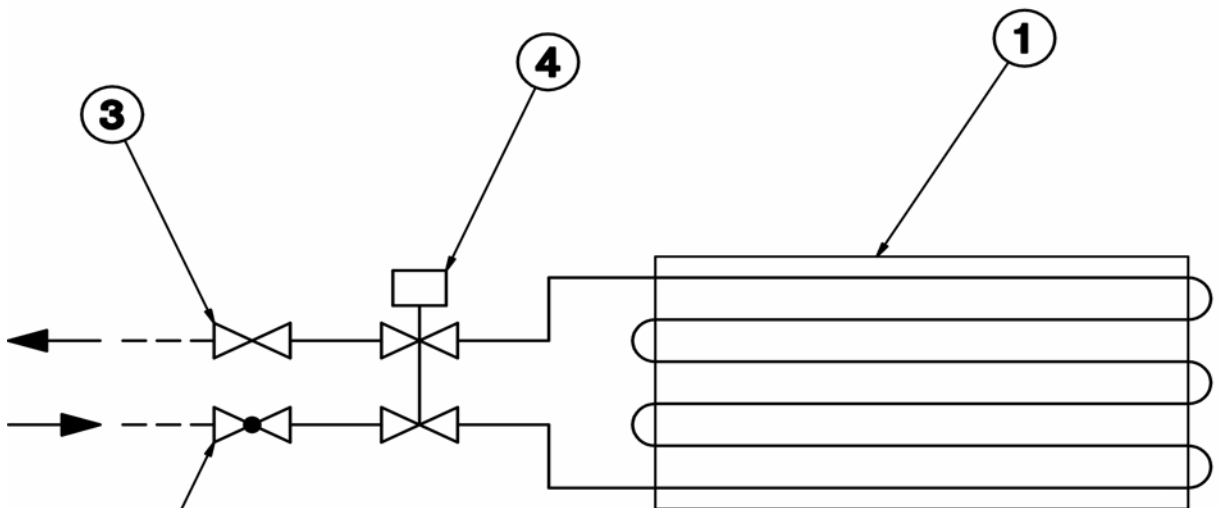

④ Actuator stem down

④ Actuator stem up

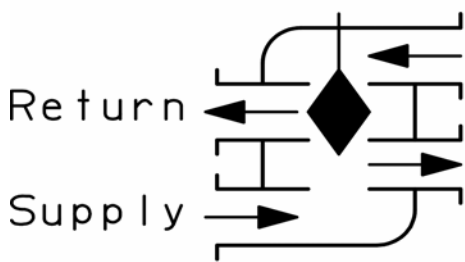

3-way NO ByPass

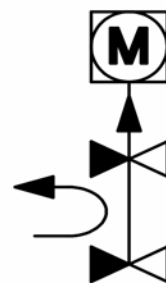



R.D. 28 Reyrieux BP 131 - 01601 Trévoux CEDEX France
Tél. 04.74.00.92.92 - Fax 04.74.00.42.00
R.C.S. Bourg-en-Bresse B 759 200 728