

INDOOR UNIT: MCAF94MR5IAA MCAF124MR5IAA MCAF184MR5IAA MCAF244MR5IAA

NOV.2003

Destination: General area (50Hz)
Europe (50Hz)
Australia (50Hz)
General area (60Hz)

DC INVERTER MULTI-SYSTEM AIR CONDITIONER

Capacity	Indoor Model No.	Product Code No.
2.8 kW	MCAF94MR5IAA	
3.6 kW	MCAF124MR5IAA	
5.0 kW	MCAF184MR5IAA	
7.0 kW	MCAF244MR5IAA	

Wall Mounted Type Indoor Unit

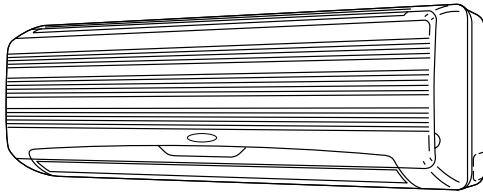

MCAF94MR5IAA

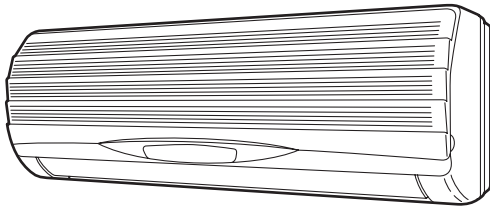

**MCAF124MR5IAA
MCAF184MR5IAA**

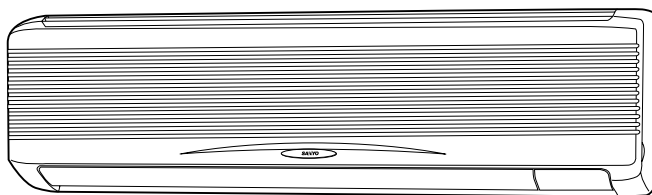

MCAF244MR5IAA

< Combined Outdoor unit >

GRF194MR5IAA (2-room multi unit)
AGRF244MR5IAA (3-room multi unit)
GRF314MR5IAA (4-room multi unit)

NOTE

1. The indoor unit MCAF244MR5IAA can only be combined with a 4-room multi unit. Therefore, do not combine it with a 2-room multi unit or 3-room multi unit.
2. For details about the combinations, refer to "Unit Combination Table" in the *T. Service Manual* for the Multi Outdoor Units.

IMPORTANT

These air conditioners employ new refrigerant R410A.

Pay special attention when servicing the unit.

R410A

Table of Contents

	Page
1. OPERATING RANGE	1
2. SPECIFICATIONS	
2-1. Unit Specifications	2
2-2. Major Component Specifications.....	6
2-3. Other Component Specifications.....	9
3. DIMENSIONAL DATA	10
4. REFRIGERANT FLOW DIAGRAM	13
5. PERFORMANCE DATA	
5-1. Air Throw Distance Chart	14
6. ELECTRICAL DATA	
6-1. Electrical Characteristics	18
7. INSTALLATION INSTRUCTIONS	
7-1. Indoor Unit	21
7-2. Connecting Indoor Units	22
7-3. Test Run	25
8. FUNCTIONS	
8-1. Operation Functions	26
8-2. Protective Functions	28
9. TROUBLESHOOTING	29
APPENDIX	33

Important!

Please Read Before Starting

This air conditioning system meets strict safety and operating standards. As the installer or service person, it is an important part of your job to install or service the system so it operates safely and efficiently.

For safe installation and trouble-free operation, you must:

- Carefully read this instruction booklet before beginning.
- Follow each installation or repair step exactly as shown.
- Observe all local, state, and national electrical codes.
- Pay close attention to all warning and caution notices given in this manual.



WARNING

This symbol refers to a hazard or unsafe practice which can result in severe personal injury or death.



CAUTION

This symbol refers to a hazard or unsafe practice which can result in personal injury or product or property damage.

If Necessary, Get Help

These instructions are all you need for most installation sites and maintenance conditions. If you require help for a special problem, contact our sales/service outlet or your certified dealer for additional instructions.

In Case of Improper Installation

The manufacturer shall in no way be responsible for improper installation or maintenance service, including failure to follow the instructions in this document.

Special Precautions

WARNING

When Wiring



ELECTRICAL SHOCK CAN CAUSE SEVERE PERSONAL INJURY OR DEATH. ONLY A QUALIFIED, EXPERIENCED ELECTRICIAN SHOULD ATTEMPT TO WIRE THIS SYSTEM.

- Do not supply power to the unit until all wiring and tubing are completed or reconnected and checked.
- Highly dangerous electrical voltages are used in this system. Carefully refer to the wiring diagram and these instructions when wiring. Improper connections and inadequate grounding can cause accidental injury or death.
- Ground the unit following local electrical codes.
- Connect all wiring tightly. Loose wiring may cause overheating at connection points and a possible fire hazard.

When Transporting

Be careful when picking up and moving the indoor and outdoor units. Get a partner to help, and bend your knees when lifting to reduce strain on your back. Sharp edges or thin aluminum fins on the air conditioner can cut your fingers.

When Installing...

...In a Ceiling or Wall

Make sure the ceiling/wall is strong enough to hold the unit's weight. It may be necessary to construct a strong wood or metal frame to provide added support.

...In a Room

Properly insulate any tubing run inside a room to prevent "sweating" that can cause dripping and water damage to walls and floors.

...In Moist or Uneven Locations

Use a raised concrete pad or concrete blocks to provide a solid, level foundation for the outdoor unit. This prevents water damage and abnormal vibration.

...In an Area with High Winds

Securely anchor the outdoor unit down with bolts and a metal frame. Provide a suitable air baffle.

...In a Snowy Area (for Heat Pump-type Systems)

Install the outdoor unit on a raised platform that is higher than drifting snow. Provide snow vents.

When Connecting Refrigerant Tubing

- Use the flare method for connecting tubing.
- Apply refrigerant lubricant to the matching surfaces of the flare and union tubes before connecting them, then tighten the nut with a torque wrench for a leak-free connection.
- Check carefully for leaks before starting the test run.

When Servicing

- Turn the power off at the main power box (mains) before opening the unit to check or repair electrical parts and wiring.
- Keep your fingers and clothing away from any moving parts.
- Clean up the site after you finish, remembering to check that no metal scraps or bits of wiring have been left inside the unit being serviced.

Others



CAUTION

- Ventilate any enclosed areas when installing or testing the refrigeration system. Escaped refrigerant gas, on contact with fire or heat, can produce dangerously toxic gas.
- Confirm upon completing installation that no refrigerant gas is leaking. If escaped gas comes in contact with a stove, gas water heater, electric room heater or other heat source, it can produce dangerously toxic gas.
- Do not install only a single indoor unit.

1. OPERATING RANGE

	Temperature	Indoor Air Intake Temp.	Outdoor Air Intake Temp.
Cooling	Maximum	32°C D.B. / 23°C W.B.	43°C D.B.
	Minimum	19°C D.B. / 14°C W.B.	19°C D.B.
Heating	Maximum	27°C D.B.	24°C D.B. / 18°C W.B.
	Minimum	16°C D.B.	— / -15°C W.B.

2. SPECIFICATIONS

2-1. Unit Specifications

Indoor Unit **MCAF94MR5IAA**

Type		Wall hang type indoor unit			
Power Source		220-240V ~ 50Hz		220V ~ 60Hz	
Voltage rating		230 V		220 V	
Performance		Cooling	Heating	Cooling	Heating
Capacity	kW	2.8 (0.7 - 3.2)	4.0 (0.9 - 5.4)	2.8 (0.7 - 3.2)	4.0 (0.9 - 5.4)
Air circulation (Hi / Me / Lo)	m³/h	620 / 510 / 370	650 / 520 / 460	620 / 510 / 370	650 / 520 / 460
Moisture removal (High)	Liters/h	1.6	—	1.6	—
Electrical Rating		Cooling	Heating	Cooling	Heating
Available voltage range	V	198 ~ 264		198 ~ 242	
Running amperes	A	0.13	0.14	0.13	0.14
Power input	W	26	28	26	28
Features					
Controls / Temperature control		Microprocessor / I.C. thermostat			
Control unit		Wireless remote control unit			
Timer		ON/OFF 24 hours & Daily program, 1-hour OFF			
Fan speeds		3 and Auto			
Airflow direction (Indoor)		Manual Auto			
Air filter		Washable, Anti-Mold			
Operation sound	Hi / Me / Lo	dB-A		41 / 38 / 33	44 / 39 / 34
Refrigerant tubing connections		Flare type			
Refrigerant tube diameter	Narrow tube	mm (in.)		6.35(1/4)	
	Wide tube	mm (in.)		9.52(3/8)	
Refrigerant		g			
Refrigerant tube kit		Optional			
Dimensions & Weight					
Unit dimensions		Height	mm	275	
		Width	mm	805	
		Depth	mm	178	
Package dimensions		Height	mm	335	
		Width	mm	860	
		Depth	mm	252	
Weight		Net	kg	8.5	
		Shipping	kg	12	
Shipping volume		m³		0.073	

DATA SUBJECT TO CHANGE WITHOUT NOTICE.

Indoor Unit **MCAF124MR5IAA**

Type		Wall hang type indoor unit			
Power Source		220~240V ~ 50Hz		220V ~ 60Hz	
Voltage rating		230 V		220 V	
Performance		Cooling	Heating	Cooling	Heating
Capacity	kW	3.6 (0.8 - 3.6)	4.8 (0.9 - 6.3)	3.6 (0.8 - 3.6)	4.8 (0.9 - 6.3)
Air circulation (Hi / Me / Lo)	m³/h	580 / 450 / 400	700 / 600 / 500	580 / 450 / 400	700 / 600 / 500
Moisture removal (High)	Liters/h	2.0	—	2.0	—
Electrical Rating		Cooling	Heating	Cooling	Heating
Available voltage range	V	198 ~ 264		198 ~ 242	
Running amperes	A	0.13	0.12	0.13	0.12
Power input	W	25	25	25	25
Features					
Controls / Temperature control		Microprocessor / I.C. thermostat			
Control unit		Wireless remote control unit			
Timer		ON/OFF 24 hours & Daily program, 1-hour OFF			
Fan speeds		3 and Auto			
Airflow direction (Indoor)		Manual			
		Auto			
Air filter		Washable, Anti-Mold			
Operation sound	Hi / Me / Lo dB-A	46 / 39 / 33	47 / 40 / 34	46 / 39 / 33	47 / 40 / 34
Refrigerant tubing connections		Flare type			
Refrigerant	Narrow tube mm (in.)	6.35(1/4)			
tube diameter	Wide tube mm (in.)	9.52(3/8)			
Refrigerant		R410A			
Refrigerant tube kit		Optional			
Dimensions & Weight					
Unit dimensions	Height	mm	285		
	Width	mm	805		
	Depth	mm	219		
Package dimensions	Height	mm	342		
	Width	mm	859		
	Depth	mm	289		
Weight	Net	kg	9.5		
	Shipping	kg	12		
Shipping volume		m³	0.085		

DATA SUBJECT TO CHANGE WITHOUT NOTICE.

Indoor Unit **MCAF184MR5IAA**

Type		Wall hang type indoor unit			
Power Source		220-240V ~ 50Hz		220V ~ 60Hz	
Voltage rating		230 V		220 V	
Performance		Cooling	Heating	Cooling	Heating
Capacity	kW	5.0 (1.1 - 5.8)	7.1 (1.2 - 7.8)	5.0 (1.1 - 5.8)	7.1 (1.2 - 7.8)
Air circulation (Hi / Me / Lo)	m³/h	680 / 620 / 530	800 / 720 / 630	680 / 620 / 530	800 / 720 / 630
Moisture removal (High)	Liters/h	2.8	—	2.8	—
Electrical Rating		Cooling	Heating	Cooling	Heating
Available voltage range	V	198 ~ 264		198 ~ 242	
Running amperes	A	0.12	0.12	0.12	0.12
Power input	W	25	25	25	25
Features					
Controls / Temperature control		Microprocessor / I.C. thermostat			
Control unit		Wireless remote control unit			
Timer		ON/OFF 24 hours & Daily program, 1-hour OFF			
Fan speeds		3 and Auto			
Airflow direction (Indoor)		Manual Auto			
Air filter		Washable, Anti-Mold			
Operation sound	Hi / Me / Lo	dB-A		49 / 44 / 38	50 / 49 / 44
Refrigerant tubing connections		Flare type			
Refrigerant tube diameter	Narrow tube	mm (in.)		6.35(1/4)	
	Wide tube	mm (in.)		9.52(3/8)	
Refrigerant		g			
Refrigerant tube kit		Optional			
Dimensions & Weight					
Unit dimensions	Height	mm		285	
	Width	mm		805	
	Depth	mm		219	
Package dimensions	Height	mm		342	
	Width	mm		859	
	Depth	mm		289	
Weight	Net	kg		9.5	
	Shipping	kg		12	
Shipping volume	m³		0.085		

DATA SUBJECT TO CHANGE WITHOUT NOTICE.

Indoor Unit **MCAF244MR5IAA**

Type		Wall hang type indoor unit			
Power Source		220-240V ~ 50Hz		220V ~ 60Hz	
Voltage rating		230 V		220 V	
Performance		Cooling	Heating	Cooling	Heating
Capacity	kW	7.0 (1.5 - 8.1)	8.0 (2.0 - 8.8)	7.0 (1.5 - 8.1)	8.0 (2.0 - 8.8)
Air circulation (Hi / Me / Lo)	m³/h	1100/1000/920	1170/1070/980	1100/1000/920	1170/1070/980
Moisture removal (High)	Liters/h	3.4	—	3.4	—
Electrical Rating		Cooling	Heating	Cooling	Heating
Available voltage range	V	198 ~ 264		198 ~ 242	
Running amperes	A	0.27	0.28	0.35	0.36
Power input	W	63	65	77	79
Features					
Controls / Temperature control		Microprocessor / I.C. thermostat			
Control unit		Wireless remote control unit			
Timer		ON/OFF 24 hours & Daily program, 1-hour OFF			
Fan speeds		3 and Auto			
Airflow direction (Indoor)	Horizontal	Manual			
	Vertical	Auto			
Air filter		Washable, Anti-Mold			
Operation sound	Hi / Me / Lo	dB-A	47 / 43 / 38	47 / 43 / 38	47 / 43 / 38
Refrigerant tubing connections		Flare type			
Refrigerant	Narrow tube	mm (in.)	6.35(1/4)		
tube diameter	Wide tube	mm (in.)	12.7(1/2)		
Refrigerant		g	R410A		
Refrigerant tube kit		Optional			
Dimensions & Weight					
Unit dimensions	Height	mm	330		
	Width	mm	1,140		
	Depth	mm	228		
Package dimensions	Height	mm	406		
	Width	mm	1,231		
	Depth	mm	325		
Weight	Net	kg	18		
	Shipping	kg	20		
Shipping volume		m³	0.162		

DATA SUBJECT TO CHANGE WITHOUT NOTICE.

2-2. Major Component Specifications

2-2-1. Indoor Unit

Indoor Unit **MCAF94MR5IAA**

Control PCB		
Part No.		POW-K5DHV5-A1
Controls		Microprocessor
Control circuit fuse		2.50V 3.15A
Remote Control Unit		RCS-3MVHPS4E
Fan & Fan Motor		
Type	Fan / Fan motor	Cross-flow / DC motor
Q'ty ... Dia. and length	mm	1 ... D92
Fan motor model ... Q'ty		DR-8538-408A ... 1
No. of poles		8
Nominal output	W	30
Coil resistance (Ambient temp. 20°C)	Ω	RED – WHT: 3.70 WHT – BLU: 3.70 BLU – RED: 3.70
Safety devices	Type	—
	Operating temp. Open °C	—
	Close	—
Run capacitor	μF	—
	VAC	—
Flap Motor and Louver Motor		
Type		Stepping motor
Model		MP24S2-5V
Rating		DC5V
Coil resistance (Ambient temp. 25°C)	Ω	WHT – BLU (respectively 4 wires): 70 ± 7%
Heat Exchanger Coil		
Coil		Aluminum plate fin / Copper tube
Rows		2
Fin pitch	mm	1.3
Face area	m ²	0.124

DATA SUBJECT TO CHANGE WITHOUT NOTICE.

Indoor Unit **MCAF184MR5IAA**
MCAF124MR5IAA

Control PCB		
Part No.		POW-K5DHV5-A
Controls		Microprocessor
Control circuit fuse		2.50V 3.15A

Remote Control Unit		RCS-3MVHPS4E
----------------------------	--	--------------

Fan & Fan Motor		
Type	Fan / Fan motor	Cross-flow / DC motor
Q'ty ... Dia. and length	mm	1 ... D100
Fan motor model ... Q'ty		DR-8538-408 ... 1
No. of poles		8
Nominal output	W	30
Coil resistance (Ambient temp. 20°C)	Ω	RED – WHT: 3.70 WHT – BLU: 3.70 BLU – RED: 3.70
Safety devices	Type	—
	Operating temp. Open °C	—
	Close	—
Run capacitor	μF	—
	VAC	—

Flap Motor and Louver Motor		
Type		Stepping motor
Model		MP24S2-5V
Rating		DC5V
Coil resistance (Ambient temp. 25°C)	Ω	WHT – BLU (respectively 4 wires): 70 ± 7%

Heat Exchanger Coil		
Coil		Aluminum plate fin / Copper tube
Rows		2
Fin pitch	mm	1.3
Face area	m ²	0.130

DATA SUBJECT TO CHANGE WITHOUT NOTICE.

Indoor Unit **MCAF184MR5IAA**

Control PCB		
Part No.		POW-KMRV243GJ
Controls		Microprocessor
Control circuit fuse		2.50V 3.15A
Remote Control Unit		RCS-3MVHPS4E
Fan & Fan Motor		
Type	Fan / Fan motor	Cross-flow / AC motor
Q'ty ... Dia. and length	mm	1 ... D100
Fan motor model ... Q'ty		KFG4X-31B6P-S ... 1
No. of poles ... rpm (220V, High)		4 ... 1269
Nominal output	W	30
Coil resistance (Ambient temp. 20°C)	Ω	BRN – WHT: 161.2 ORG – YEL: 26.9 WHT – VLT: 11.6 YEL – BLK: 22.8 VLT – ORG: 68.7 BLK – PNK: 115.2
Safety devices	Type	Thermal protector
	Operating temp. Open °C	130 ± 8
	Close °C	79 ± 15
Run capacitor	μF	1.5
	VAC	480
Flap Motor and Louver Motor		
Type		Stepping motor
Model		MP24GA2 ... 2
Rating		DC 12V
Coil resistance (Ambient temp. 20°C)	Ω	Each terminal (1-2, 1-3, 1-4, 1-5): 400 ± 7%
Heat Exchanger Coil		
Coil		Aluminum plate fin / Copper tube
Rows		2
Fin pitch	mm	1.3
Face area	m ²	0.214

DATA SUBJECT TO CHANGE WITHOUT NOTICE.

2-3. Other Component Specifications

Indoor Unit
MCAF94MR5IAA
MCAF124MR5IAA
MCAF184MR5IAA
MCAF244MR5IAA

• Indoor air temp sensor

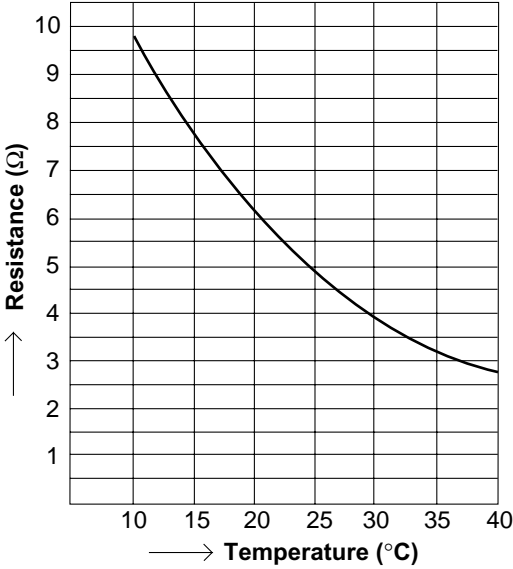

• Indoor heat exchanger sensor

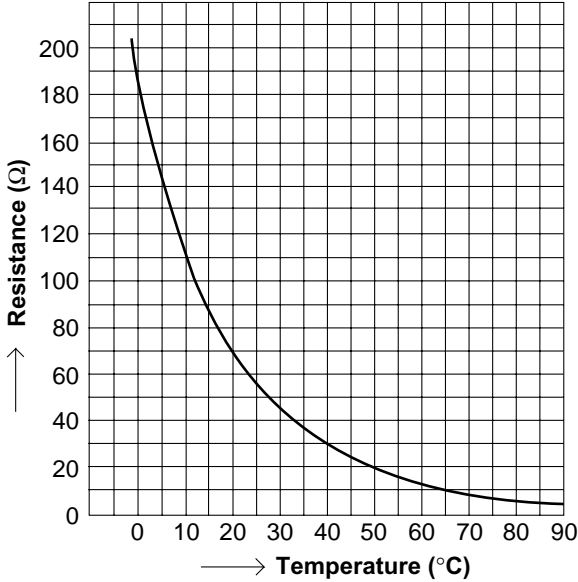

• Humidity sensor

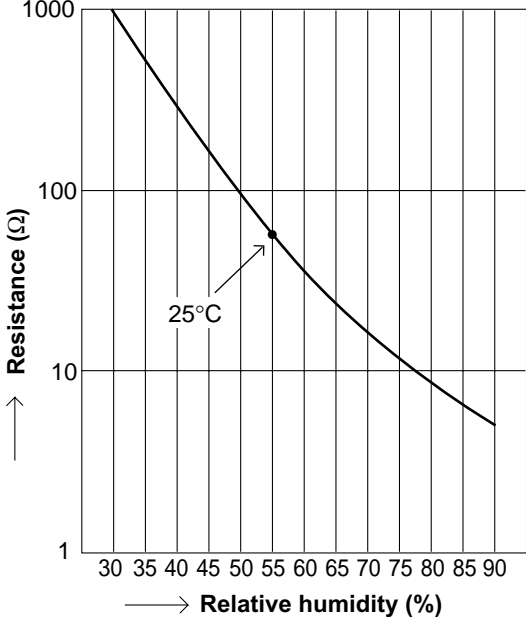

3. DIMENSIONAL DATA

Indoor Unit **MCAF94MR5IAA**

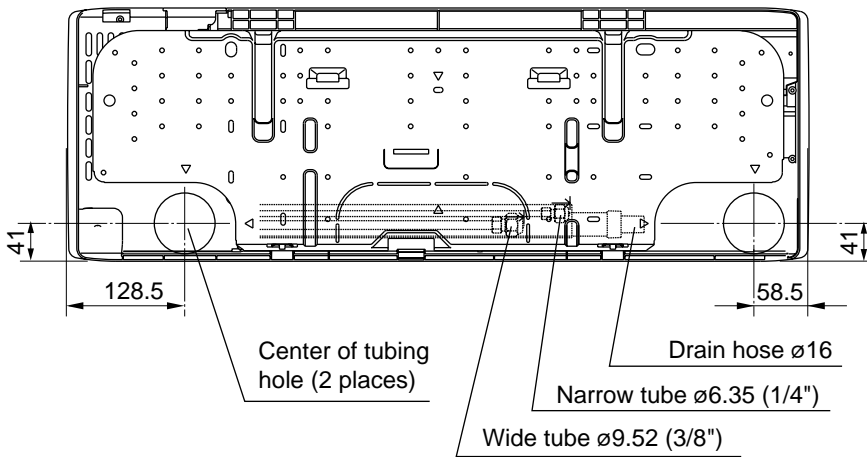
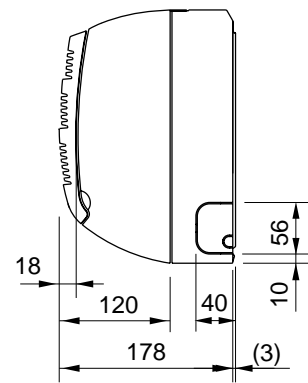
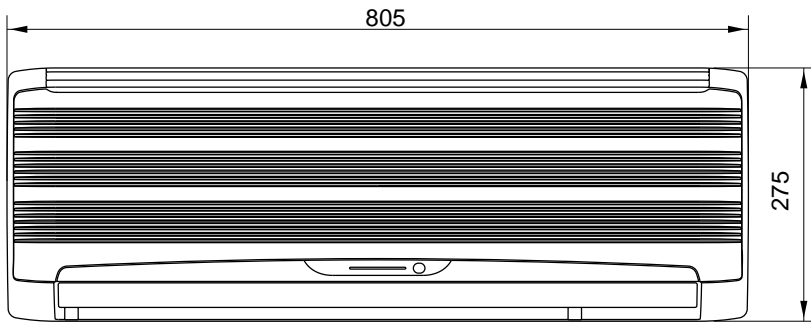
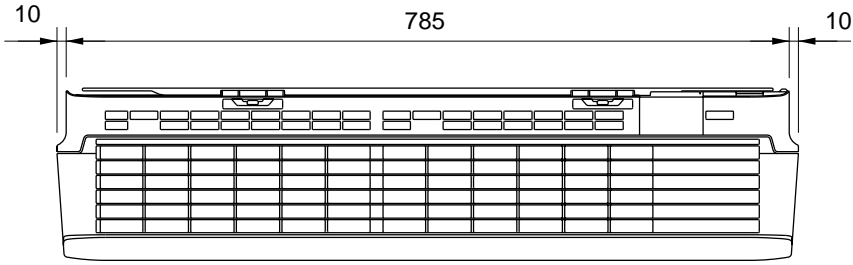

Remote control unit

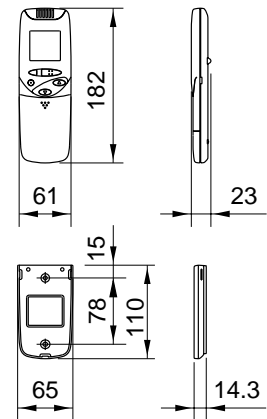

unit: mm

Indoor Unit

MCAF124MR5IAA
MCAF184MR5IAA

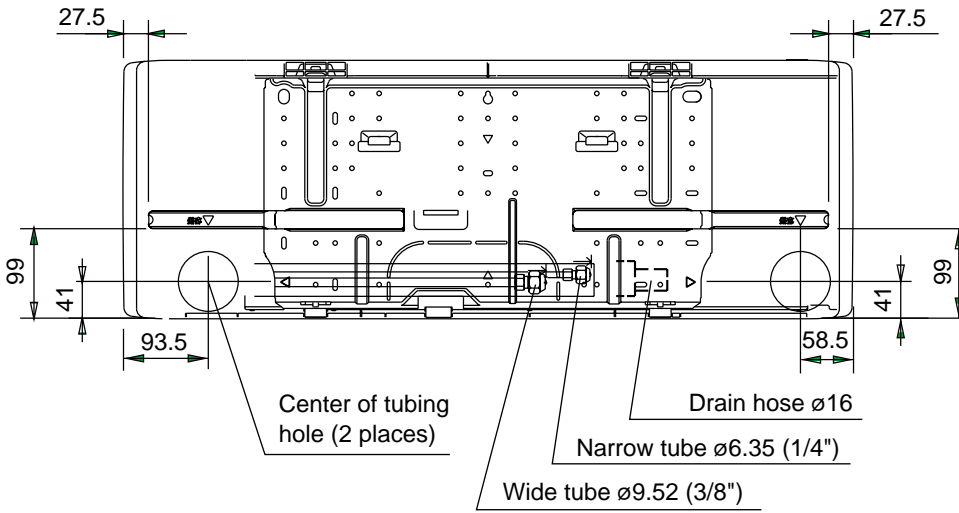
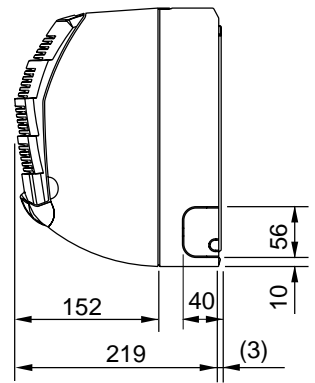
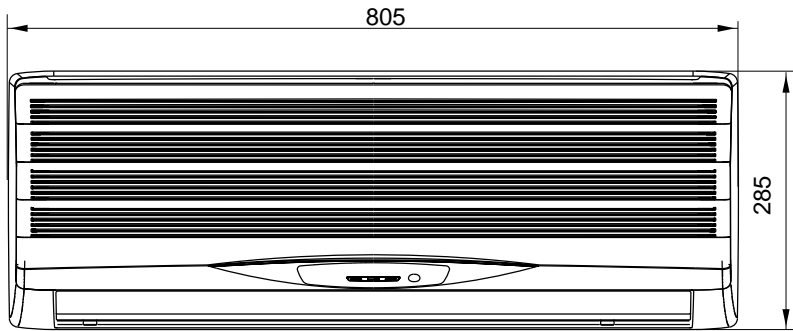
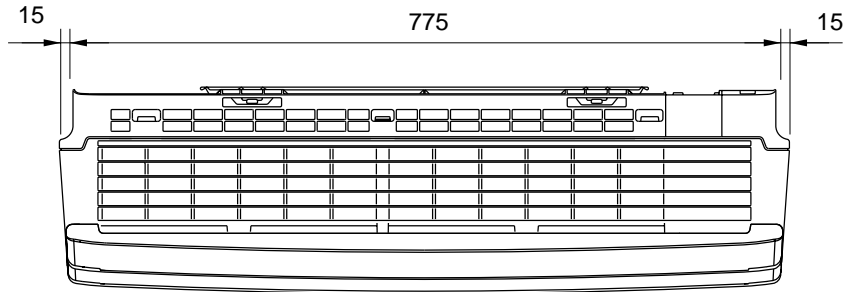

Remote control unit

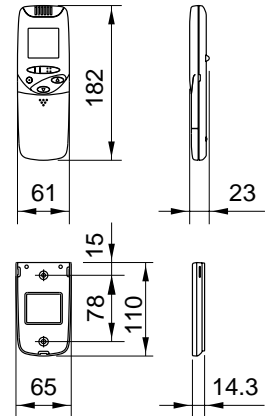

unit: mm

Indoor Unit

MCAF244MR5IAA

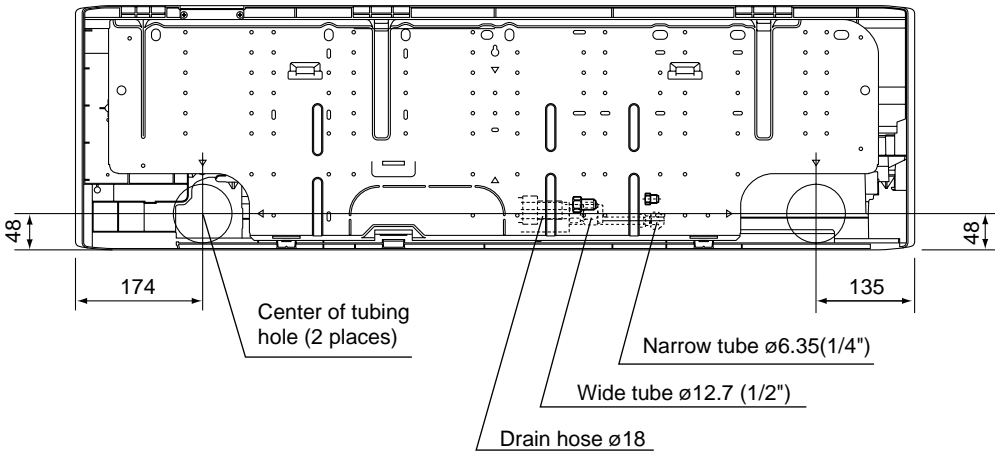
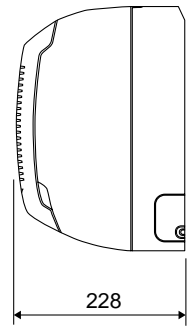
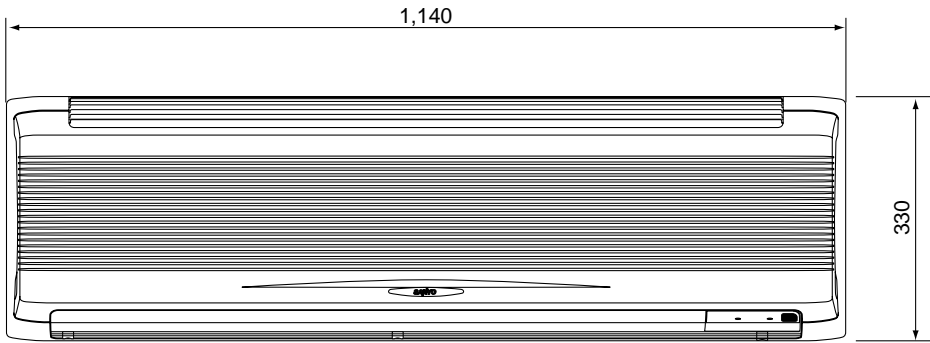

Remote control unit

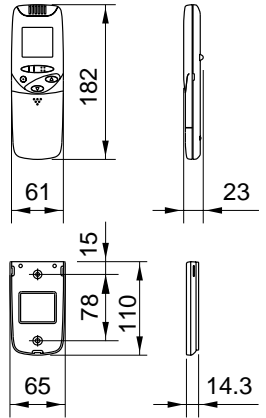

unit: mm

4. REFRIGERANT FLOW DIAGRAM

Indoor Unit

MCAF94MR5IAA
MCAF124MR5IAA
MCAF184MR5IAA

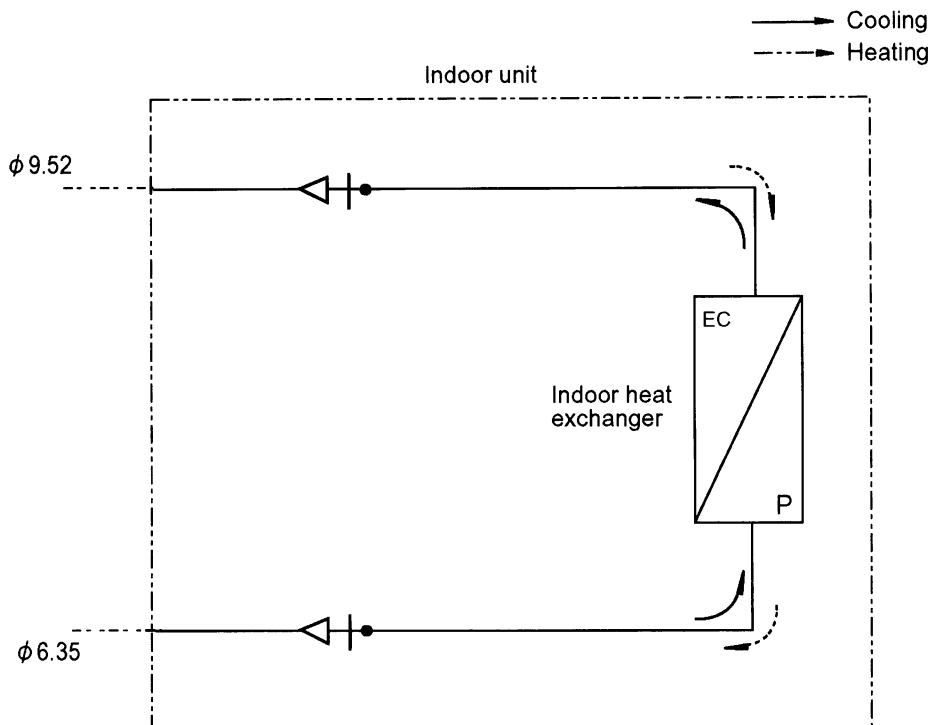

Indoor Unit

MCAF244MR5IAA

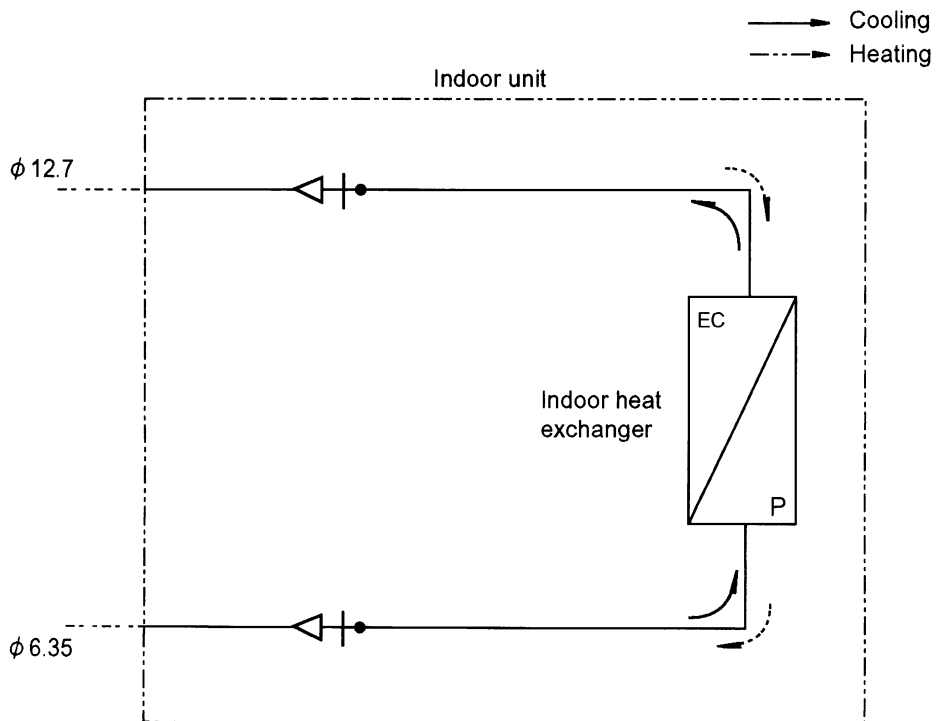

5. PERFORMANCE DATA

5-1. Air Throw Distance Chart

Indoor Unit MCAF94MR5IAA

Cooling

Room air temp. : 27°C
 Fan speed : High

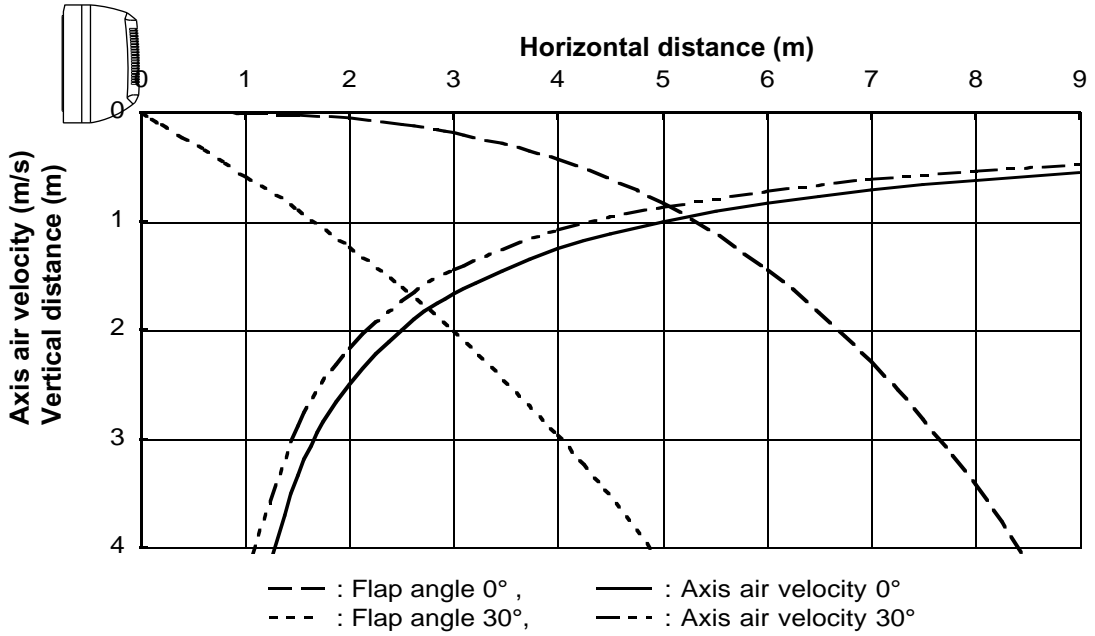

Heating

Room air temp. : 20°C
 Fan speed : High

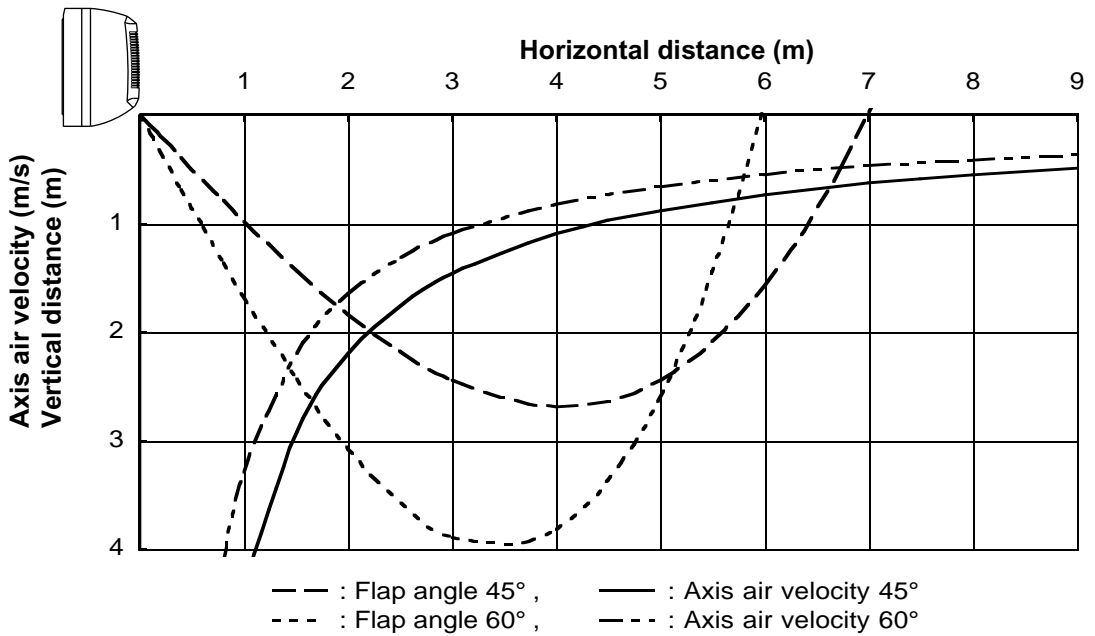

Cooling

Room air temp. : 27°C
 Fan speed : High

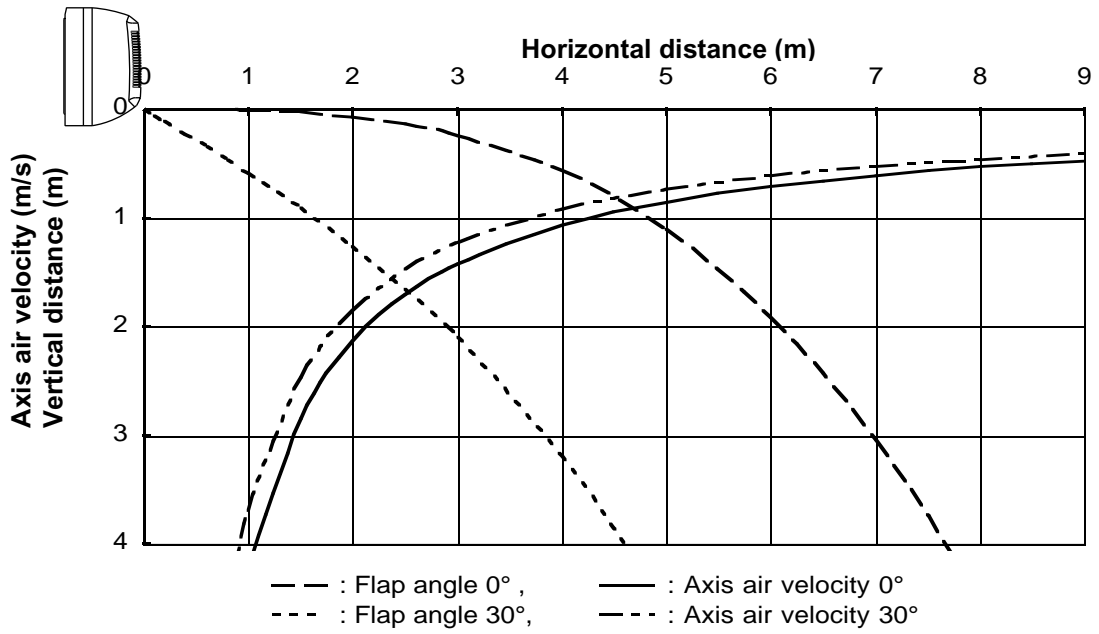

Heating

Room air temp. : 20°C
 Fan speed : High

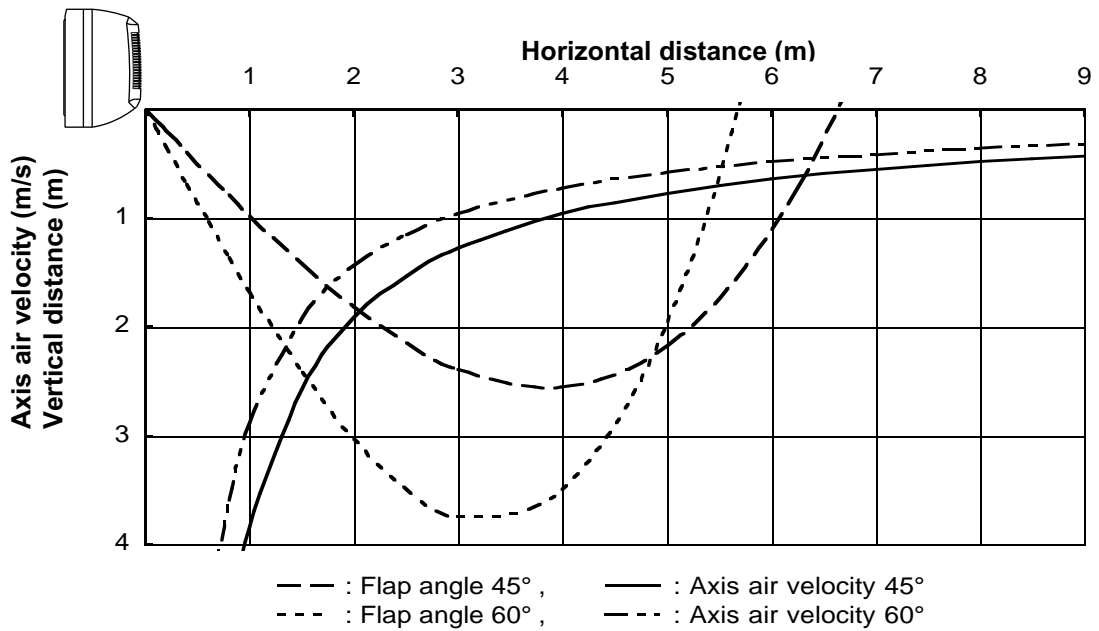

Cooling

Room air temp. : 27°C
 Fan speed : High

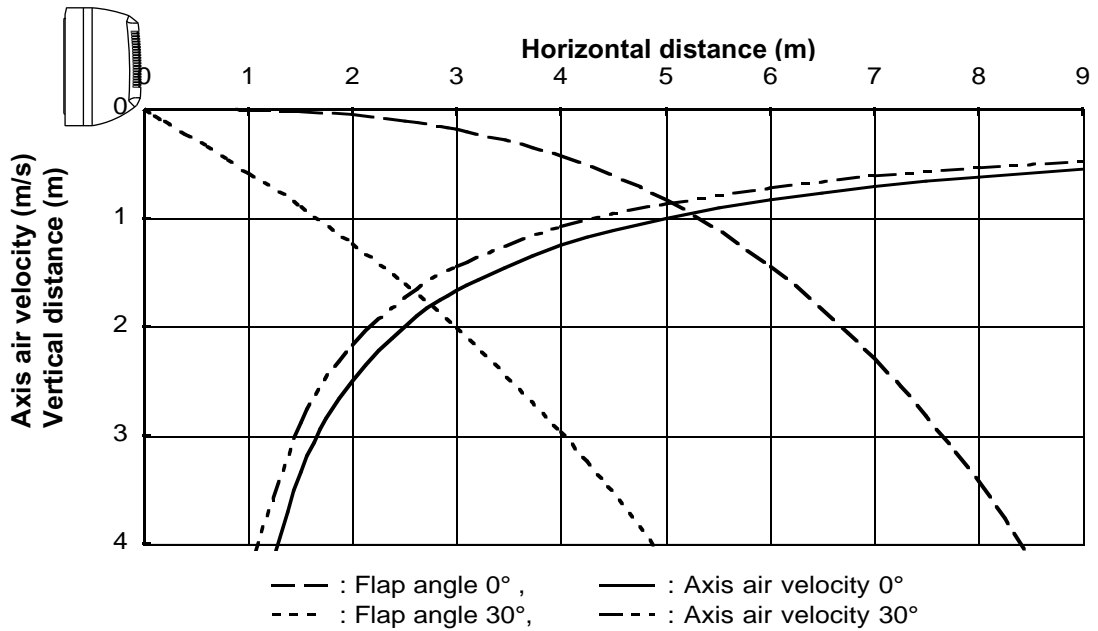

Heating

Room air temp. : 20°C
 Fan speed : High

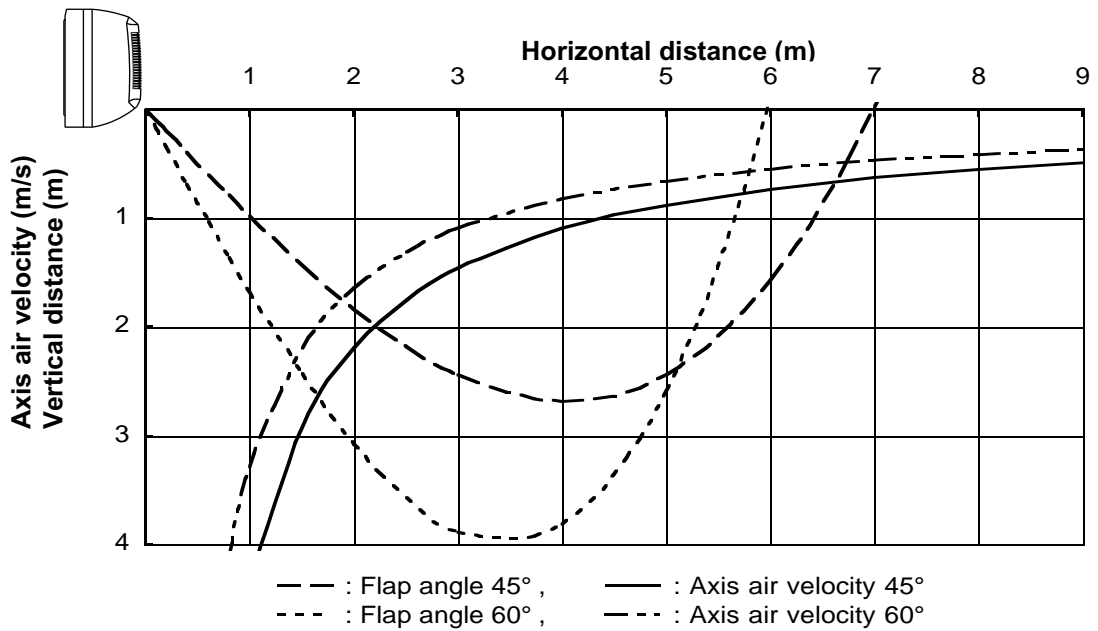

Cooling

Room air temp. : 27°C
 Fan speed : High

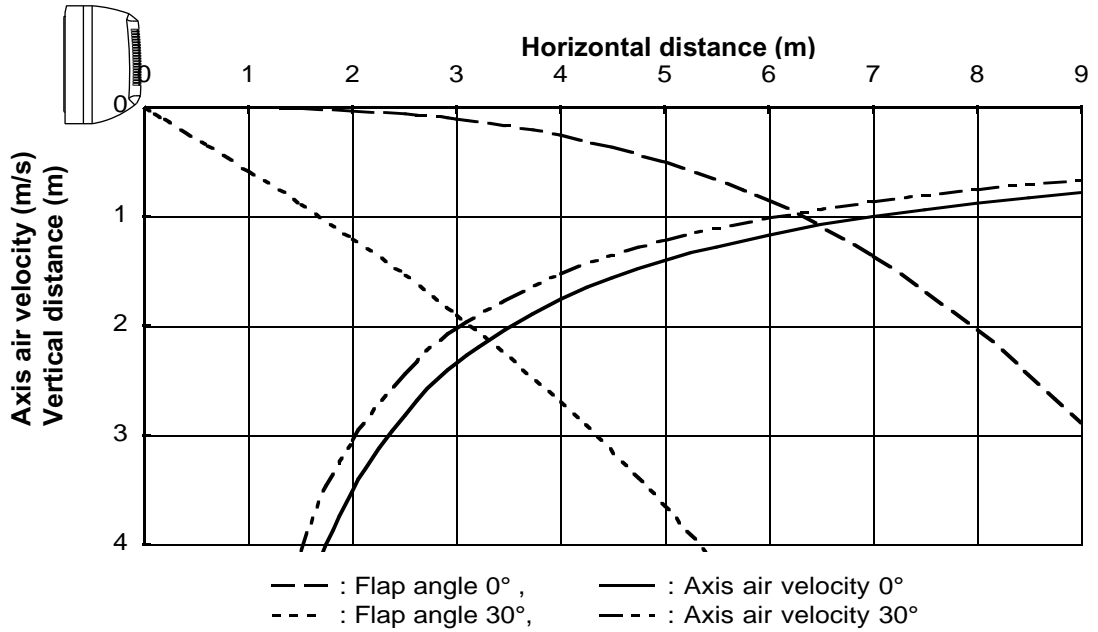

Heating

Room air temp. : 20°C
 Fan speed : High

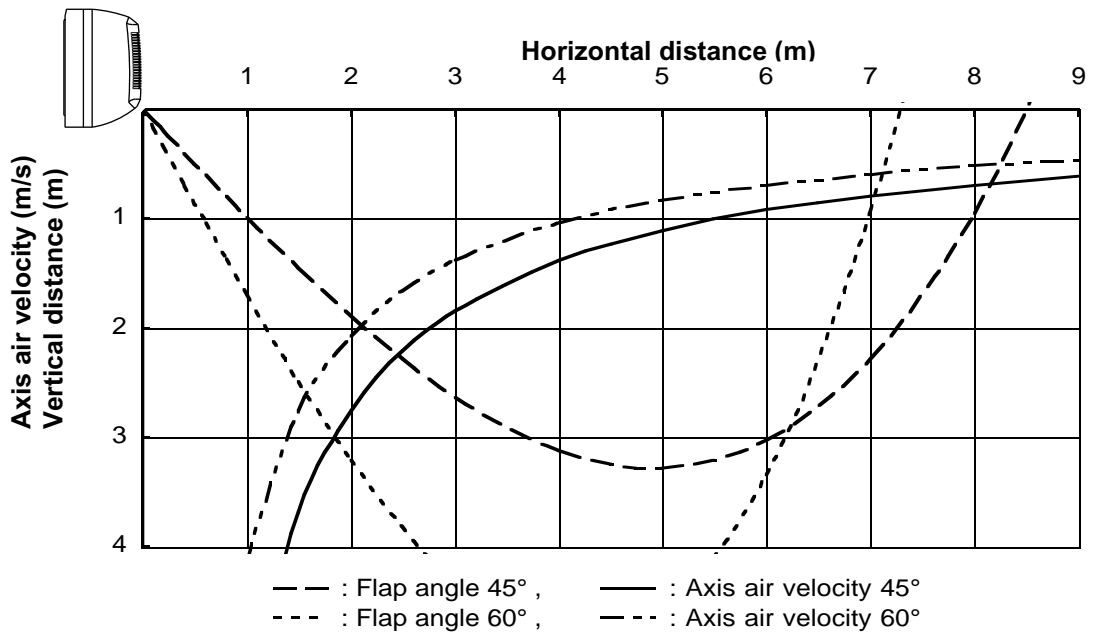

6. ELECTRICAL DATA

6-1. Electrical Characteristics

Indoor Unit MCAF94MR5IAA



WARNING *To avoid electrical shock hazard, be sure to disconnect power before checking, servicing and/or cleaning any electrical parts.*

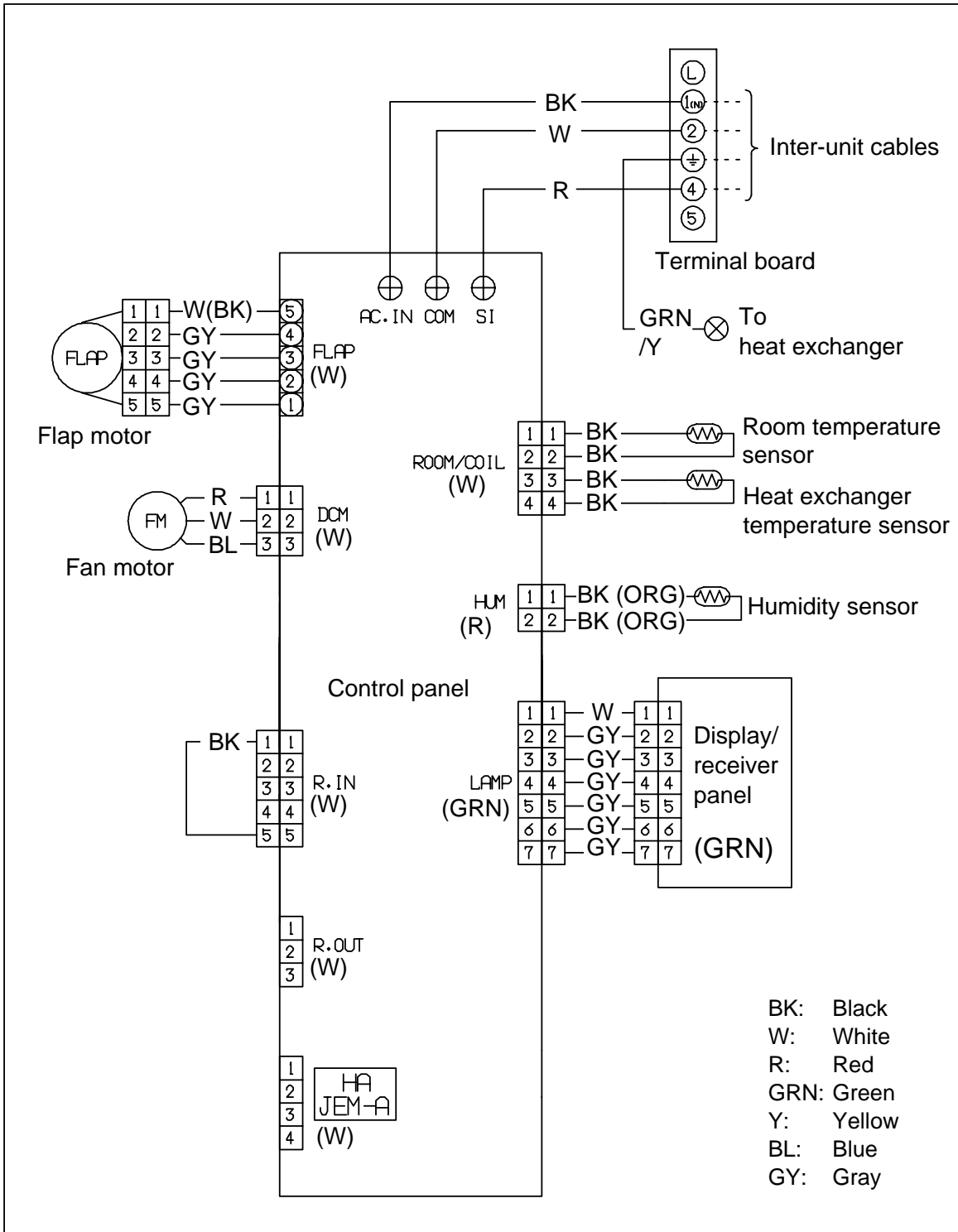

Indoor Unit

MCAF124MR5IAA
MCAF184MR5IAA



WARNING

To avoid electrical shock hazard, be sure to disconnect power before checking, servicing and/or cleaning any electrical parts.

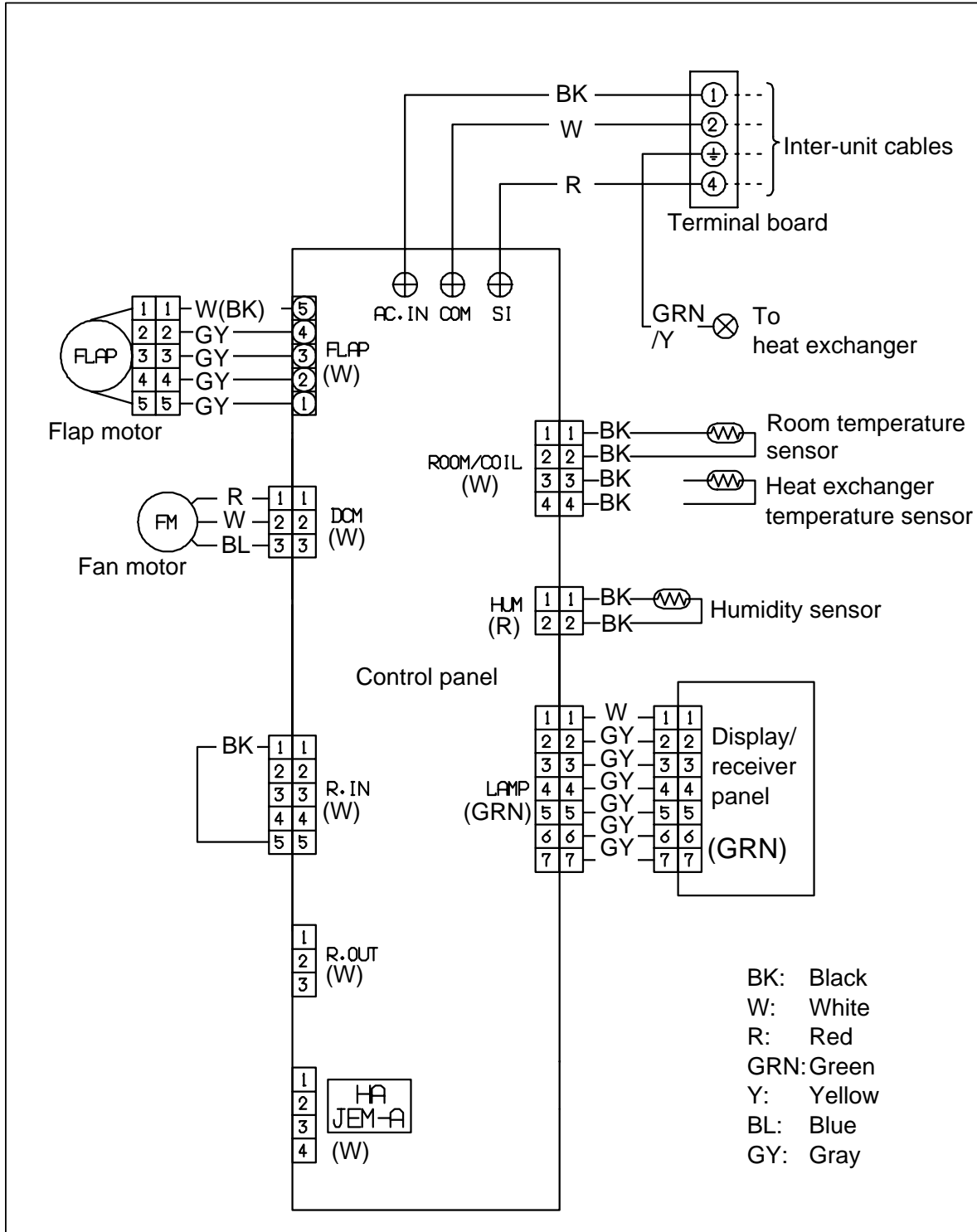



WARNING

To avoid electrical shock hazard, be sure to disconnect power before checking, servicing and/or cleaning any electrical parts.

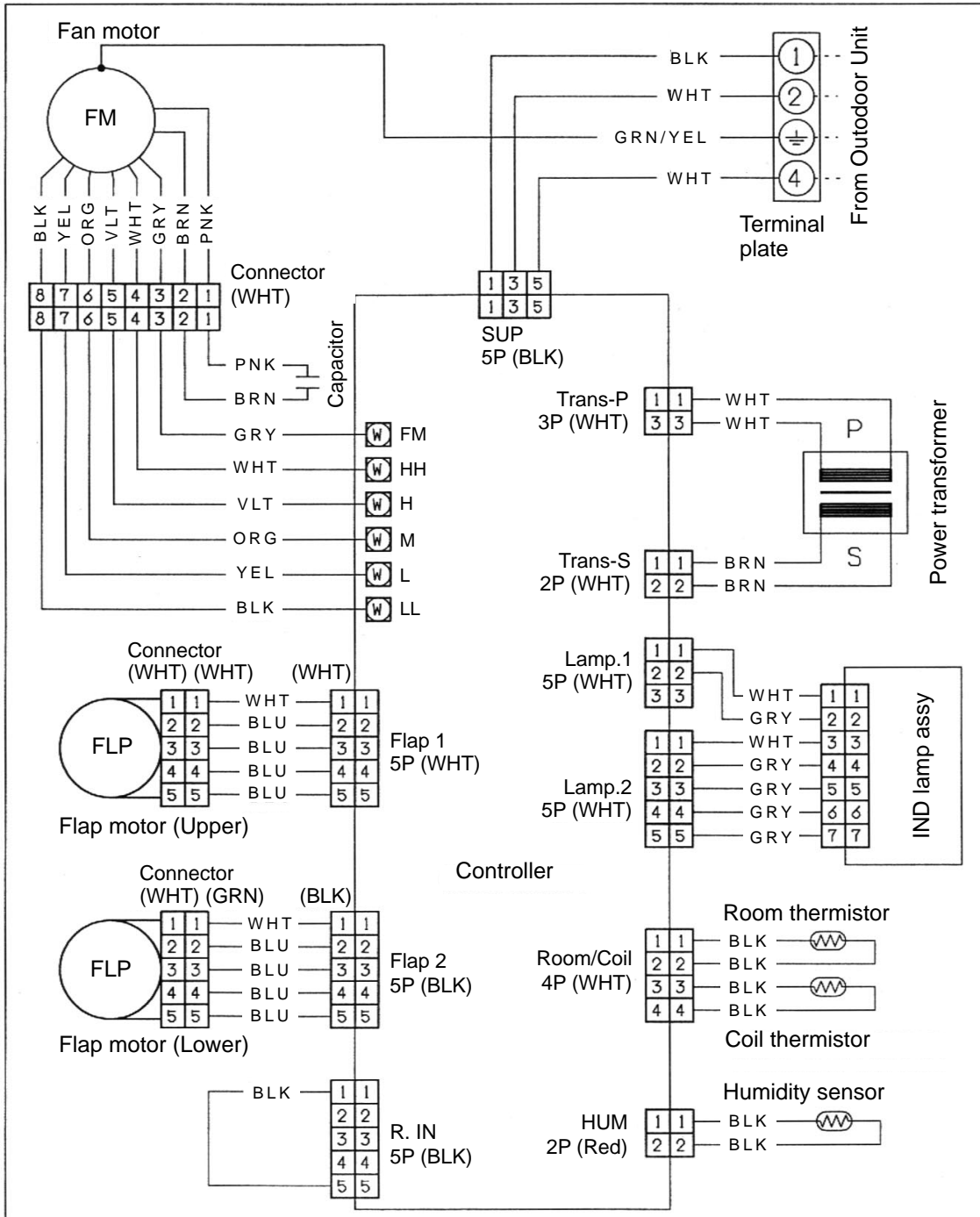

7. INSTALLATION INSTRUCTIONS

Installation Site Selection

7-1. Indoor Unit



WARNING

To prevent abnormal heat generation and the possibility of fire, do not place obstacles, enclosures, and grilles in front of or surrounding the air conditioner in a way that may block air flow.

AVOID:

- direct sunlight.
- nearby heat sources that may affect performance of the unit.
- areas where leakage of flammable gas may be expected.
- placing or allowing any obstructions near the A/C inlet or outlet.
- installing in rooms that contain instant-on (rapid-start) fluorescent lamps. (These may prevent the A/C from receiving signals.)
- places where large amounts of oil mist exist.
- installing in locations where there are devices that generate high-frequency emissions.

DO:

- select an appropriate position from which every corner of the room can be uniformly cooled. (High on a wall is best.)
- select a location that will hold the weight of the unit.
- select a location where tubing and drain hose have the shortest run to the outside. (Fig. 1)
- allow room for operation and maintenance as well as unrestricted air flow around the unit. (Fig. 2)
- install the inter-unit cable more than 1 meter away from any antenna or power lines or connecting wires used for television, radio, telephone, security system, or intercom. Electrical noise from any of these sources may affect operation.

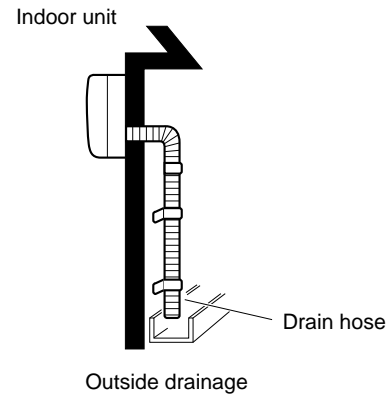
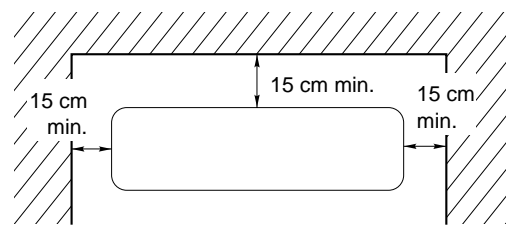

Fig. 1



Front View

Fig. 2

- install in a sturdy manner to avoid increased operating noise.
- install the unit within the maximum elevation difference (H1, H2, H3, H4) above or below the outdoor unit and within a total tubing length (L1+L2, L1+L2+L3, L1+L2+L3+L4) from the outdoor unit as detailed in Table 1 and Fig. 3a.

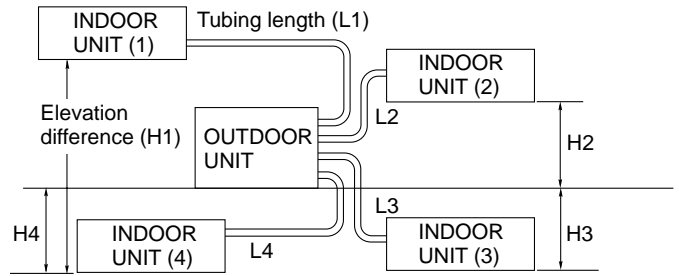

Fig. 3a

Table 1

Model (Outdoor unit)	Max. Allowable Tubing Length per unit (m)	Limit of Total Tubing Length (L1+L2), (L1+L2+L3) or (L1+L2+L3+L4) (m)	Limit of Elevation Difference (H) (m)
GRF194MR5IAA	25	35 (L1+L2)	10
GRF244MR5IAA	25	50 (L1+L2+L3)	10
GRF314MR5IAA	30	70 (L1+L2+L3+L4)	10



CAUTION
 For stable operation of the air conditioner, do not install wall-mounted type indoor units less than 1.5 m from floor level.

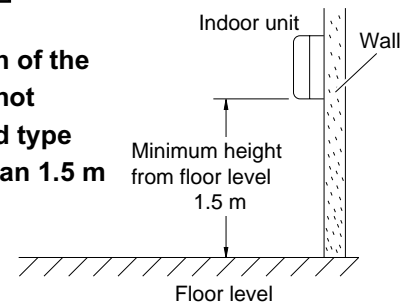

Fig. 3b

7-2. Connecting Indoor Units

(1) Connecting indoor unit types (9- 12 - 18) for GRF194MR5IAA

Note: It is not possible to connect the outdoor unit for 2 rooms to indoor unit type 70.

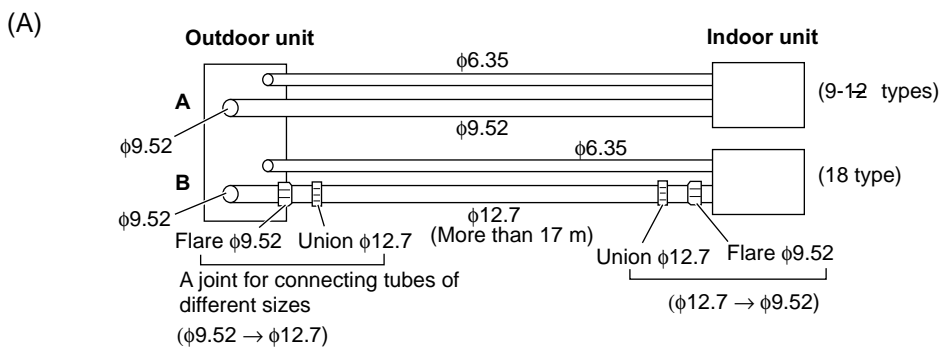

Fig. 4a

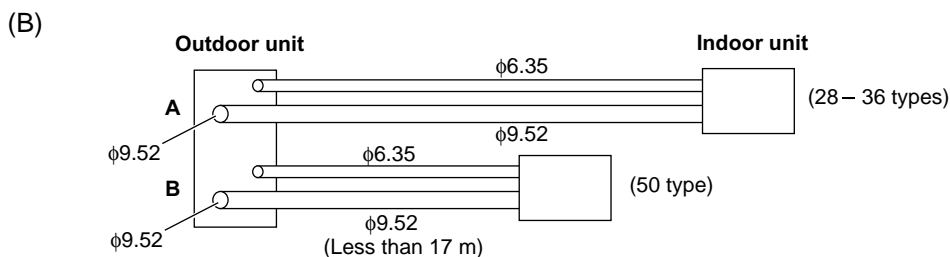

Fig. 4b

(B) Connecting indoor unit type 18 at D (Length of tube: more than 17 m)

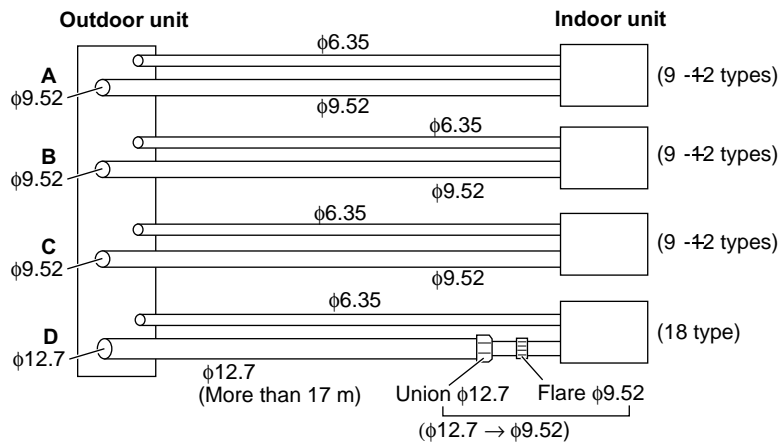

Fig. 4f

(C) Connecting indoor unit type 18 at D (Length of tube: less than 17 m)

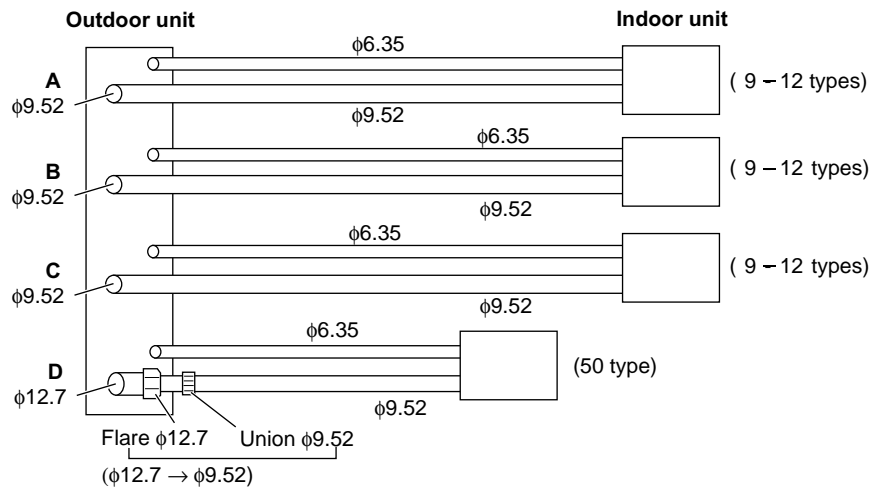

Fig. 4g

(D) Connecting indoor unit type 24 at D

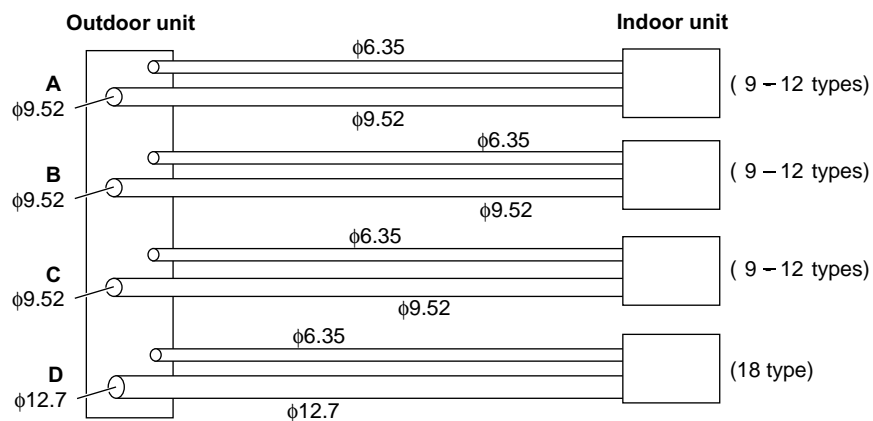

Fig. 4h

7-3. Test Run

- (1) Turn the indoor unit selector switch to the "ON" position. (Fig. 5)
 - (2) With the remote controller, start heating or cooling operation.
 - (3) Turn the selector switch to "TEST RUN." (The indicator lamp blinks during test run operation.)
 - (4) After the test run is completed, turn the selector switch to "ON." Operation stops, and remote controller control becomes possible.
- If the OPERATION lamp only blinks or the outdoor unit does not start approximately 5 minutes after the start of the test run, perform self-diagnosis by switching to OFF. Follow the self-diagnosis procedure listed on the right inside of the grille. The combination of the 3 indicator lamps indicates the condition of the system. (Fig. 6)

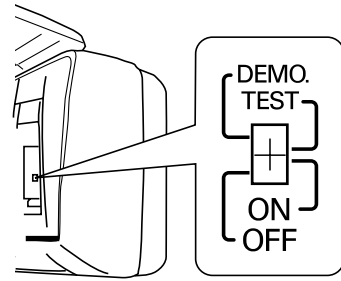

Fig. 5

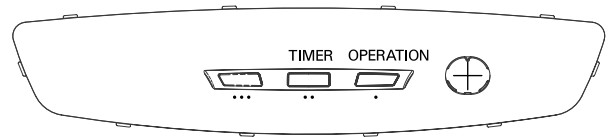

Fig. 6

8. FUNCTIONS

8-1. Operation Functions

■ Functions of the main unit controller

- ① **OFF (Self-diagnostics)** : • Used to stop the unit when the remote controller is unavailable.
• Used when service inspection is performed.
- ② **ON** : • During normal operation: Starts operation from the remote controller.
• Emergency operation: When the remote controller is unavailable, moving this switch from the OFF position to the ON position starts automatic operation.
- ③ **TEST** : • Used when operating performance are checked.
• Used when pump-down is carried out. (Operates at the rated frequency. At this time, the main unit lamp flashes, and the remote controller signal cannot be received.)
- ④ **DEMO** : • This function is for shop displays. Ordinarily it is not used.
• Used during servicing.

■ Automatic operation

● Operating mode selection

When automatic operation is selected, the indoor and outdoor temperature sensors function, and either HEAT, DRY, or COOL mode operation is selected automatically.

		Indoor temperature			Set temperature (standard)
		(Approx.) 15°C	22°C	27°C	
Outdoor air temperature	(Approx.) 22°C	HEAT mode	DRY mode	COOL mode	27°C
	20°C			Temperature at which operation starts (Range: 20 – 26°C)	
	18°C			24°C	

- When multiple indoor units are connected and this unit is started while another indoor unit is operating, the operating mode is as shown in the table below.

Operating mode before change	Multi operating mode	Operating mode after change
HEAT	COOL	DRY
	DRY	DRY
COOL	HEAT	HEAT
DRY	HEAT	HEAT

- If the remote controller is used to start automatic operation, a differing-mode check is performed if the operating modes are not the same.

● Desired-temperature memory

- The set temperature in the program can be changed as desired within the range of $\pm 4^\circ\text{C}$. This temperature can then be stored. During automatic operation, press the temperature setting buttons to change the temperature.

■ SENSOR DRY

During automatic operation, the system adjusts the room temperature and fan speed according to the conditions in the room, in order to maintain a comfortable room environment.

SENSOR DRY operation

- DRY operation is as shown in the figure below.

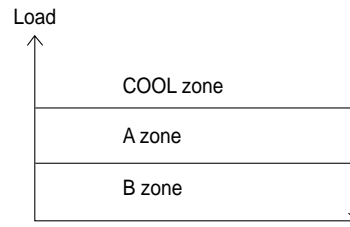

Conditions are monitored at all times when the room temperature is below 15°C.

DRY A

The compressor operation frequency varies depending on the relative humidity. The indoor fan operates with 1/f fluctuation.

DRY B

The compressor operates at a low operating frequency. The indoor fan operates with 1/f fluctuation.

Monitor

- Monitoring operation takes place when the room temperature is below 15°C.
- When the monitoring range is entered, the compressor stops, and the indoor fan operates at LL.

■ PAM- α control

- In order to further improve inverter performance, control is switched between PWM control at low operation speeds, and PAM control at high operation speeds, making the most effective use of power.

■ HIGH POWER

Raises the power but remains in the same operating mode. This function is set with the HIGH POWER button on the remote controller.

(It is set regardless of the temperature and fan speed settings.)

● HIGH POWER operation from the remote controller

The unit operates at maximum output for 15 minutes, regardless of the desired temperature.

The fan speed is 1 step above "High."

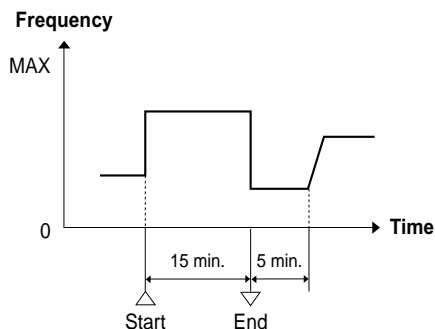

NOTE

- When HIGH POWER operation ends, the unit operates at low Hz for 5 minutes, regardless of the thermostat OFF conditions.
- When in DRY mode, operation is in the cooling zone.
- When in HEAT mode, defrosting does not occur during HIGH POWER operation.
- If HIGH POWER is set while defrosting is in progress, HIGH POWER operation begins after defrosting ends.
- HIGH POWER operation cannot be set from the remote controller when the unit is stopped.
- HIGH POWER operation and ECONOMY operation cannot be used at the same time. The function set last takes priority.

■ ECONOMY

- When ECONOMY operation is set, the temperature and fan speed settings will be adjusted automatically to allow comfortable sleep.
- When ECONOMY operation is set, "😊 mark" appears on the remote controller.

● COOL and DRY modes

- The indoor unit fan speed is automatically lowered for quiet operation.
- The temperature setting is raised by 1°C one hour after ECONOMY operation is set.

● HEAT mode

- The indoor unit and outdoor unit fan speeds are automatically lowered for quiet operation.
- The temperature setting is lowered by 3°C one hour after ECONOMY operation is set. In addition, the temperature setting is lowered by 4°C after two hours have passed.

■ Lamp colors

Operation lamp

- HEAT operation : Red
- DRY operation : Orange
- COOL operation : Green
- TIMER lamp : Green

■ ON timer operation

- Operation starts when the time set for the ON timer is reached. When a time is set, the TIMER lamp illuminates.
- The below comfort timer programming is performed. A comfort time is calculated from the set temperature and the room temperature, either 60 minutes prior or 30 minutes prior to the set ON timer time, and operation is started in advance of the set ON time. (The indoor fan speed is "Medium.")

[COOL]

Indoor temperature – Set temperature = Temperature difference

[HEAT]

Set temperature – Indoor temperature = Temperature difference

Temperature difference (°C)	Advance start time (min.)
12 < Temperature difference	60
6 < Temperature difference	30

NOTE

This function does not operate if the ON timer standby time is less than 30 minutes.

■ OFF timer operation

- Operation stops when the time set for the OFF timer is reached. When a time is set, the TIMER lamp illuminates.

■ Timer backup

- If the indoor unit is unable to receive the timer time-end signal when the ON or OFF time is reached, then timer time-end occurs according to the indoor unit backup timer within approximately 26 minutes.
- Operation stops if there are no operator controls for 25 hours or longer after unit operation switched from OFF to ON by use of ON timer operation.

8-2. Protective Functions

■ Overload prevention during heating

During HEAT operation, the temperature of the indoor heat exchanger is used to control the frequency and lessen the load on the compressor before the protective device is activated.

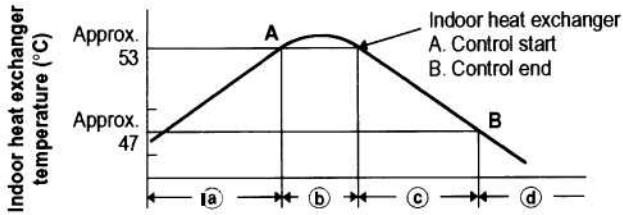

- (a) area: Automatic capacity control
- (b) When Point A has been exceeded, the operation frequency is reduced by a certain proportion.
- (c) area: Frequency increase is prohibited.
- (d) At Point B and below, overload prevention is ended and control is the same as in the (a) area.

■ Freeze prevention

During COOL or DRY operation, freezing is detected and operation is stopped when the temperature of the indoor heat exchanger matches the conditions below.

- ① Freeze-prevention operation is engaged when the temperature of the indoor heat exchanger is below 6°C.
- ② Restart after freeze-prevention operation occurs when the temperature of the indoor heat exchanger reaches 8°C or above.

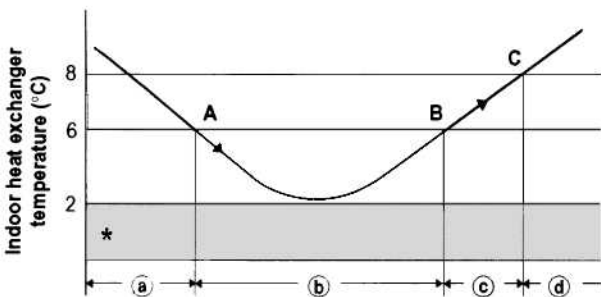

- (a) area: Automatic capacity control
- (b) When the temperature drops below Point A, the operation frequency is reduced by a certain proportion.
- (c) area: Frequency increase is prohibited.
- (d) When the temperature reaches Point C or above, freezing prevention is ended and control is the same as in the (a) area.

* When the temperature drops to below 2°C (continuously for 2 minutes or longer), the compressor stops. Once the freeze condition is detected, the air conditioner will work less than the maximum frequency until it is turned off.

■ Cold-air prevention during heating

During heating, the fan speed is set to "LL" (very low) or stopped. As the temperature of the indoor heat exchanger rises, the fan speed is changed to the set speed.

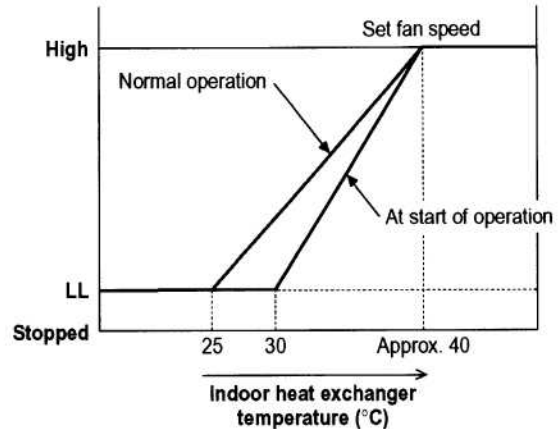

NOTE

- The fan speed is forcibly changed to "LL" beginning 30 seconds after the thermostat turns OFF.
- Normal operation refers to operation when the room temperature has approached the set temperature.
- When HEAT operation starts, the indoor fan is stopped until the temperature of the indoor heat exchanger reaches 20°C or higher, or until the room temperature reaches 15°C or higher.

■ Changing the remote controller address

• This prevents remote controller signal interference when two Sanyo air conditioners are installed next to each other. Ordinarily, the address is set to A. If it is necessary to change the address, follow the procedure below. If 3 or more (up to 4) units are installed, use remote controllers that are intended for servicing use.

- ① Switch the address setting to "B" by removing the tab marked "A" on the remote controller.
- ② Insert dry-cell batteries into the remote controller and press the **[ACL]** button. Then attach the cover.
- ③ Open the air intake grille on the indoor unit, and move the operation switch to the DEMO position.
- ④ Press the **[ON/OFF]** operation button on the remote controller. Check that the "beep" signal-received sound is heard from the indoor unit.
- ⑤ Move the operation switch to the ON position, and close the intake grille.
- ⑥ Operate the remote controller. Check that the "beep" signal-received sound is heard from the indoor unit.

9. TROUBLESHOOTING

■ Precautions before performing inspection or repair

- After checking the self-diagnostics monitor, turn the power OFF before starting inspection or repair.
- High-capacity electrolytic capacitors are used inside the outdoor unit controller (inverter). They retain an electrical charge (charging voltage DC 280 V) even after the power is turned OFF, and some time is required for the charge to dissipate. Be careful not to touch any electrified parts before the controller LED (red) turns OFF.
If the outdoor controller is normal, approximately 30 seconds will be required for the charge to dissipate. However, allow at least 5 minutes for the charge to dissipate if there is thought to be any trouble with the outdoor controller.
After inspection or repair is completed, be sure to move the operation switch to the DEMO position, turn the power ON, and erase the diagnostics contents.

■ Method of self-diagnostics

If the indoor unit operation lamp is flashing every 0.5 seconds, follow the procedure below to perform detailed trouble diagnostics.

NOTE

- 1: If the operation lamp flashes every 0.5 seconds immediately when the power is turned ON, there is an external ROM (OTP data) failure on the indoor circuit board or ROM socket insertion problem, or the ROM has not been installed.
- 2: The failure mode is stored in memory even when the power is not ON. Follow the procedure below to perform diagnostics.

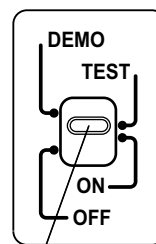

Operation selector

Ordinarily, this switch should be in the ON position. The OFF, TEST, and DEMO positions are used for inspection.

PROCEDURE

- ① Turn the power switch ON.
- ② Move the operation selector on the main unit to OFF (self-diagnostics).
- ③ If there is a sensor failure or a protective function has activated, self-diagnostics lamps 1, 2, and 3 will illuminate in the following pattern: 5 seconds flashing (illuminated) + 2 seconds OFF. (Buzzer sounds once while lamps are OFF.)
Note: If there is no trouble, then self-diagnostics lamps 1, 2, and 3 do not illuminate, and the buzzer does not sound.
- ④ Diagnostics is completed when the buzzer sounds 3 beeps.
- ⑤ After inspection or repair is completed, be sure to move the operation selector to the DEMO position, turn the power ON, and erase the diagnostics contents. Then move the selector to the OFF position and check that the diagnostics contents have been erased before using the unit.

Details of Self-Diagnostics

When the operation selector on the indoor unit is moved from the ON or TEST position to the OFF (Self-diagnostics) position, the indicator lamps on the indoor unit will flash (or remain ON) for 5 seconds and then turn OFF for 2 seconds (buzzer sounds once) to indicate the presence of a sensor failure or the activation of a protective function.

Self-diagnostics is completed when the buzzer sounds 3 beeps.

If there is no trouble, the lamps do not flash (illuminate). Also note that the corresponding parts listed below may not be present in some models.

Indication on indoor unit				✕ ... OFF	☀ ... Flashing	☀ ... ON	
● ● ●	● ●	●	Code	Diagnosics item	Diagnosics contents		
✕	✕	☀	S01	Room temperature sensor failure	① Sensor open circuit or short circuit		
✕	☀	✕	S02	Indoor heat exchanger sensor failure	② Contact failure at connector or open circuit at terminal crimping location (short-circuit detection only for the humidity sensor)		
✕	☀	☀	S03	Humidity sensor failure	③ Indoor/outdoor circuit board failure		
☀	✕	✕	S04	• Compressor temperature sensor failure • SH sensor failure	① Sensor open circuit or short circuit		
☀	✕	☀	S05	• Outdoor heat exchanger sensor failure • Outdoor narrow tubing sensor failure	② Contact failure at connector or open circuit at terminal crimping location ③ Outdoor circuit board failure		
☀	☀	✕	S06	• Outdoor air temperature sensor failure • Outdoor wide tubing sensor failure			
☀	☀	☀	S07	Outdoor electrical current sensor failure	Outdoor circuit board failure		
✕	✕	☀	E01	Indoor/outdoor communications failure (serial communications)	① Miswiring ② AC power failure ③ Blown fuse ④ Power relay failure ⑤ Indoor or outdoor circuit board failure		
✕	☀	✕	E02	• HIC circuit failure • Power Tr circuit failure	① HIC or power Tr failure ② Outdoor fan does not turn. ③ Instantaneous power outage ④ Service valve not opened. ⑤ Outdoor fan blocked. ⑥ Continuous overload operation ⑦ Compressor failure ⑧ Outdoor circuit board failure		
✕	☀	☀	E03	Outdoor unit external ROM failure	① External ROM data failure ② Outdoor circuit board failure		
☀	✕	✕	E04	Peak current cut-off	① Instantaneous power outage ② HIC or power Tr failure ③ Outdoor circuit board failure		
☀	✕	☀	E05	• PAM circuit failure • Active circuit failure	① Outdoor circuit board failure ② Outdoor power supply voltage failure		
☀	☀	✕	E06	Compressor discharge overheat prevention	① Electric expansion valve failure ② Capillaries blocked. ③ No gas ④ Continuous overload operation ⑤ Outdoor fan does not turn. ⑥ Outdoor circuit board failure		
☀	☀	☀	E07	Indoor fan operating failure	① Fan motor failure ② Contact failure at connector ③ Indoor circuit board failure		
☀	☀	☀	E08	• 4-way valve switching failure • Indoor zero-cross failure	① 4-way valve failure ② Outdoor circuit board failure		
☀	☀	☀	E09	No-refrigerant protection	① Service valve not opened. ② No refrigerant		
☀	☀	☀	E10	DC compressor drive circuit failure	① Open phase ② Outdoor circuit board failure		
☀	☀	☀	E11	Outdoor AC fan operating failure	① Fan motor failure ② Contact failure at connector ③ Outdoor circuit board failure		
☀	☀	☀	E12	• Outdoor system communications failure • Outdoor Hi-pressure SW, OLR operation • Outdoor power supply open phase, outdoor coil freezing	① Miswiring ② Blown fuse ③ Power relay failure ④ Open phase ⑤ Outdoor circuit board failure ⑥ Compressor failure		
☀	☀	☀	E13	Freeze-prevention operation	① Indoor fan system failure ② No refrigerant ③ Low-temperature operation		

NOTE : If the operation lamp continues to flash (orange) even when the indoor unit operation selector has been moved to the OFF position, an indoor unit external ROM failure has occurred. (E14)

After inspection or repair is completed, be sure to move the operation selector to the DEMO position, turn the power ON, and erase the diagnostics contents.

■ If the self-diagnostics function fails to operate

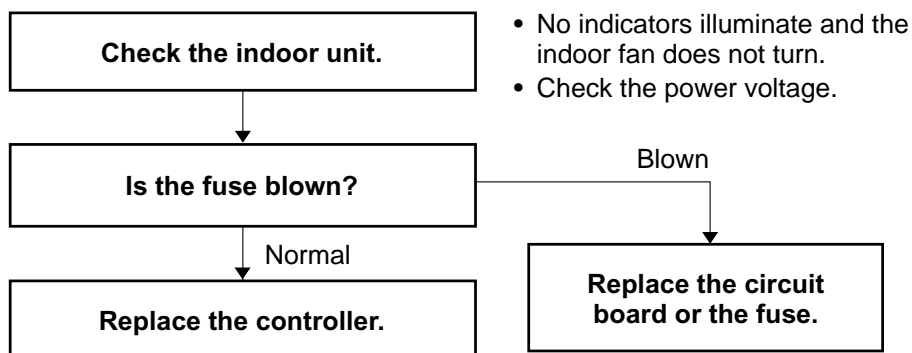

<Checking the indoor and outdoor units>

■ Checking the indoor unit

No.	Control	Check items (unit operation)
1	Set operation selector of indoor unit to DEMO and start operation using the remote controller.	<ul style="list-style-type: none"> • The rated voltage must be present between inter-unit cables 1 and 2. • Connect a 5 kΩ resistor between inter-unit cables 2 and 3. When the voltage at both ends is measured, approximately 12–15 V DC must be output and the needle must fluctuate once every 8 seconds. In addition, insert an LED jig and check that the LED flickers once every 8 seconds.

- If there are no problems with the above, then check the outdoor unit.

■ Checking the outdoor unit

No.	Control	Check items (unit operation)
1	Apply the rated voltage between outdoor unit terminals 1 and 2.	<ul style="list-style-type: none"> • The control panel LED (red) must illuminate.
2	Short-circuit the outdoor unit COM terminal to the T-RUN terminal.	<ul style="list-style-type: none"> • The compressor and fan motor must turn ON.

- If there are no problems with the above, then check the indoor unit.

● Using the TEST/T-RUN terminals

T-RUN : Test run (compressor and fan motor turn ON.)

TEST/MV : Compresses time to 1/60th (accelerates operation by 60 times faster than normal).
Fully opens the electric expansion valve.

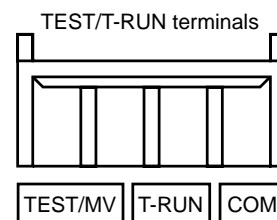

■ Checking the serial communications

Initial self-diagnostics	→ Control 1	→ Control 2	Probable location of malfunction
	Short-circuit terminals 2 and 3 on the indoor unit 3P terminal block.	Short-circuit terminals 2 and 3 on the indoor unit 3P terminal block.	
(1) illuminate	No change	—	Indoor unit circuit board failure
	Change: (1) and (3) illuminate, and (2) flashes.	Change: (1) and (3) illuminate, and (2) flashes.	Outdoor unit circuit board failure
(1) and (3) illuminate, and (2) flashes.	Change: (1) and (3) illuminate, and (3) flashes.	Change: (1) illuminates	Failure (open circuit, contact failure, etc.) in the inter-unit cable
	—	—	Indoor unit circuit board failure

- Turn the power OFF before performing short circuiting work.
- During the self-diagnostics check, the check results are the first indication when the operation switch is moved to OFF while the indicators are flashing after power ON → DEMO (5 seconds) → ON.
- So that the check can be made quickly, indicators flash at first communication after power ON.
- Before performing the above checks, perform DEMO operation, and check that AC 220 V is output to terminals 1 and 2. If it is not output, there is a failure related to the indoor unit power.

<Noise malfunction and electromagnetic interference>

An inverter A/C operates using pulse signal control and high frequencies. Therefore, it is susceptible to the effects of external noise, and is likely to cause electromagnetic interference with nearby wireless devices.

A noise filter is installed for ordinary use, preventing these problems. However, depending on the installation conditions, these effects may still occur. Please pay attention to the points listed below.

■ Noise malfunction

This refers to the application of high-frequency noise to the signal wires, resulting in abnormal signal pulses and malfunction.

Locations most susceptible to noise	Trouble	Correction
<ol style="list-style-type: none"> 1. Locations near broadcast stations where there are strong electromagnetic waves 2. Locations near amateur radio (short wave) stations 3. Locations near electronic sewing machines and arc-welding machines 	<p>Either of the following trouble may occur.</p> <ol style="list-style-type: none"> 1. The unit may stop suddenly during operation. 2. Indicator lamps may flicker. 	<p>(The fundamental concept is to make the system less susceptible to noise.)</p> <p>— Insulate for noise or distance from the noise source. —</p> <ol style="list-style-type: none"> 1. Use shielded wires. 2. Move unit away from the noise source.

■ Electromagnetic interference

This refers to the noise generated by high-speed switching of the microcomputer and compressor. This noise radiates through space and returns to electric wiring, affecting any wireless devices (televisions, radios, etc.) located nearby.

Locations most susceptible to noise	Trouble	Correction
<ol style="list-style-type: none"> 1. A television or radio is located near the A/C and A/C wiring. 2. The antenna cable for a television or radio is located close to the A/C and A/C wiring. 3. Locations where television and radio signals are weak. 	<ol style="list-style-type: none"> 1. Noise appears in the television picture, or the picture is distorted. 2. Static occurs in the radio sound. 	<ol style="list-style-type: none"> 1. Select a separate power source. 2. Keep the A/C and A/C wiring at least 1 meter away from wireless devices and antenna cables. 3. Change the wireless device's antenna to a high-sensitivity antenna. 4. Change the antenna cable to a BS coaxial cable. 5. Use a noise filter (for the wireless device). 6. Use a signal booster.

APPENDIX INSTRUCTION MANUAL

Wall Mounted Type Indoor Unit

Features

This air conditioner is equipped with cooling, heating, and drying functions. Details on these functions are provided below; refer to these descriptions when using the air conditioner.

- **Microprocessor Controlled Operation**
The interior compartment of the remote control unit contains several features to facilitate automatic operation, easy logically displayed for easy use.
- **Simple One-touch Wireless Remote Control**
The remote control unit has several features to facilitate automatic operation.
- **24-Hour ON or OFF Timer**
This timer can be set to automatically turn the unit on or off at 10 minutes intervals within a 24 hour period.
- **1-Hour OFF Timer**
This timer can be set to automatically turn off the unit at any time after one hour.
- **ECONOMY Mode**
Pressing this button changes the setting of the room temperature thermostat, allowing you to set the temperature at whatever level that you find comfortable.
- **Automatic and 3-step Fan Speed**
Auto/High/Medium/Low
- **Air Sweep Control**
This function moves a flap up and down in the air outlet, directing air in a sweeping motion around the room and providing comfort in every corner.
- **High Power Cooling**
When a cooling or drying operation is to be performed, the air conditioner operates for 15 minutes in the high power mode.
- **Odor Reduction Mode**
When a cooling or drying operation is to commence, the indoor fan motor is shut down for 40 seconds to minimize the odors which are produced when operation starts up.
- **Mold Inhibiting Mode**
Upon completion of a cooling or drying operation, the indoor fan motor operates in the fan mode for 30 seconds to prevent condensation inside the indoor unit and inhibit the growth of mold.
- **Anti-Mold Filter**
This unit is equipped with an anti-mold filter that inhibits the growth of mold and bacteria.
- **Air Clean Filter**
An air filter that uses antibacterial filter to eliminate unpleasant odors and clean the air.

Contents

	Page
Features	2
Product Information	3
Alert Symbols	3
Installation Location	4
Electrical Requirements	4
Safety Instructions	4
Names of Parts	5
Using the Remote Control Unit	11
Operation with the Remote Control Unit	12
1. Automatic Operation	12
2. Manual Operation	13
3. Adjusting the Fan Speed	15
4. ECONOMY Mode	15
Special Remarks	17
Setting the Timer	18
Setting the 1-Hour OFF Timer	21
Setting the HIGH POWER Operation	21
Tips for Energy Saving	22
Adjusting the Airflow Direction	23
Operation without the Remote Control Unit	24
Care and Cleaning	24
Troubleshooting	27
Operating Range	27

EG

Product Information

If you have problems or questions concerning your Air Conditioner, you will need the following information. Model and serial numbers are on the nameplate on the bottom of the cabinet.

Model No. _____ Serial No. _____

Date of purchase _____

Dealer's address _____

Phone number _____

DECLARATION OF CONFORMITY

This product is marked «**CE**» as it satisfies EEC Directive No. 89/336/EEC, 73/23/EEC and 93/68/EEC.

This declaration will become void in case of mis-usage and/or from non observance though partial of Manufacturer's installation and/or operating instructions.

Alert Symbols

The following symbols used in this manual, alert you to potentially dangerous conditions to users, service personnel or the appliance:



WARNING

This symbol refers to a hazard or unsafe practice which can result in severe personal injury or death.



CAUTION

This symbol refers to a hazard or unsafe practice which can result in personal injury or product or property damage.

Installation Location

- We recommend that this air conditioner be installed properly by qualified installation technicians in accordance with the Installation Instructions provided with the unit.
- Before installation, check that the voltage of the electric supply in your home or office is the same as the voltage shown on the nameplate.



WARNING

- Do not install this air conditioner where there are fumes or flammable gases, or in an extremely humid space such as a greenhouse.
- Do not install the air conditioner where excessively high heat-generating objects are placed.

Avoid: To protect the air conditioner from heavy corrosion, avoid installing the outdoor unit where salty sea water can splash directly onto it or in sulphurous air near a spa.

Electrical Requirements

1. All wiring must conform to the local electrical codes. Consult your dealer or a qualified electrician for details.
2. Each unit must be properly grounded with a ground (or earth) wire or through the supply wiring.
3. Wiring must be done by a qualified electrician.

Safety Instructions

- Read this Instruction Manual carefully before using this air conditioner. If you still have any difficulties or problems, consult your dealer for help.
- This air conditioner is designed to give you comfortable room conditions. Use this only for its intended purpose as described in this Instruction Manual.



WARNING

- Never use or store gasoline or other flammable vapor or liquid near the air conditioner – it is very dangerous.
- This air conditioner has no ventilator for intaking fresh air from outdoors. You must open doors or windows frequently when you use gas or oil heating appliances in the same room, which consume a lot of oxygen from the air. Otherwise there is a risk of suffocation in an extreme case.



CAUTION

- Do not turn the air conditioner on and off from the power mains switch. Use the ON/OFF operation button.
- Do not stick anything into the air outlet of the outdoor unit. This is dangerous because the fan is rotating at high speed.
- Do not let children play with the air conditioner.
- Do not cool or heat the room too much if babies or invalids are present.

Names of Parts

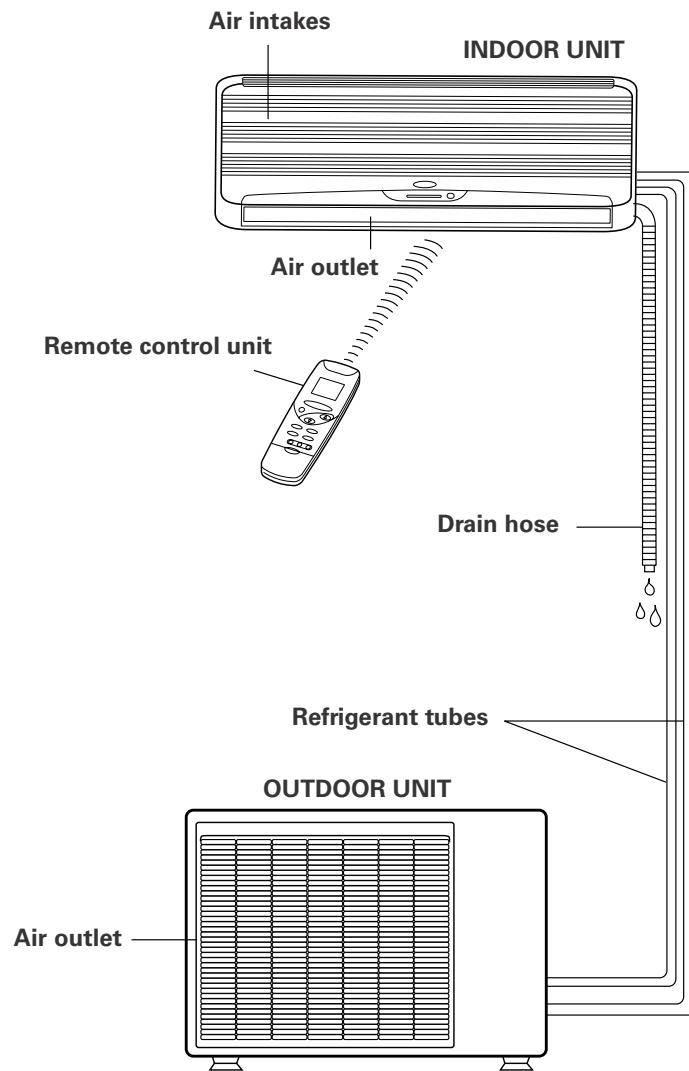

EG

NOTE

This illustration is based on the external view of a standard model. Consequently, the shape may differ from that of the air conditioner which you have selected.

This air conditioner consists of an indoor unit and an outdoor unit. You can control the air conditioner with the remote control unit.

Air Intake	Air from the room is drawn into this section and passes through air filters which remove dust.
Air Outlet	Conditioned air is blown out of the air conditioner through the air outlet.
Remote Control Unit	The wireless remote control unit controls power ON/OFF, operation mode selection, temperature, fan speed, timer setting, and air sweeping.
Refrigerant Tubes	The indoor and outdoor units are connected by copper tubes through which refrigerant gas flows.
Drain Hose	Moisture in the room condenses and drains off through this hose.
Outdoor (Condensing) Unit	The outdoor unit contains the compressor, fan motor, heat exchanger coil, and other electrical components.

Unit Display and Operation Selector

MCAF94/124/184MR5IAA
INDOOR UNIT

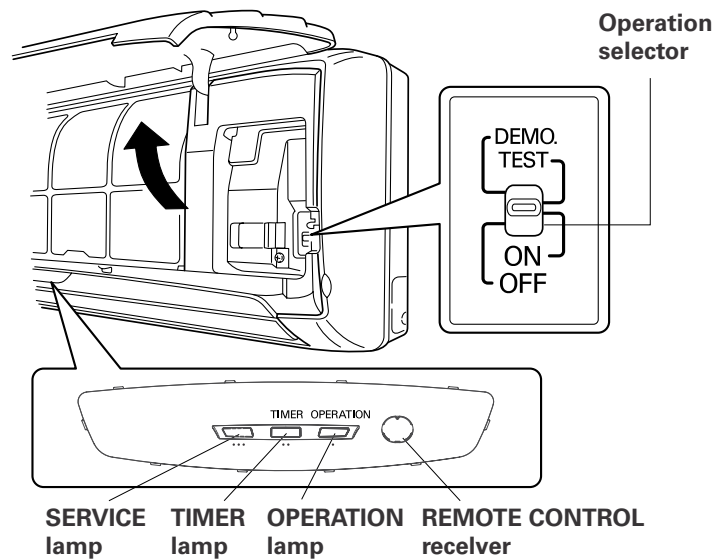

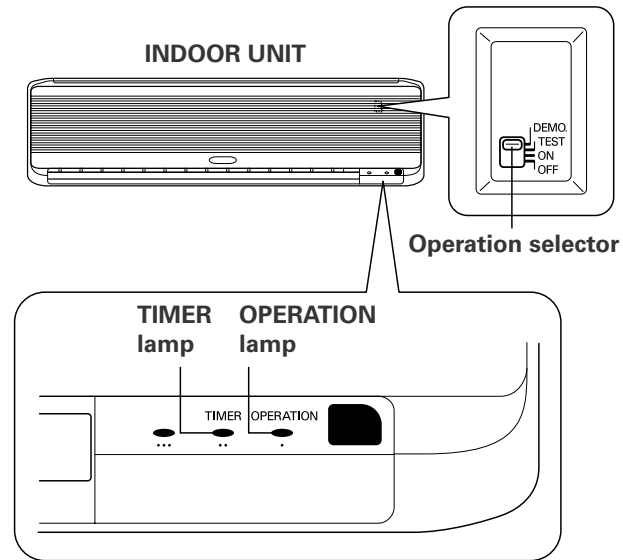

MCAF244MR5IAA



IMPORTANT

Avoid using radio equipment such as mobile phone near (within 1 m) the remote control receiver. Some radio equipment may cause malfunction of the unit.

If the trouble happens, disconnect power and restart the air conditioner after a few minutes.

REMOTE CONTROL receiver	This section picks up infrared signals from the remote control unit (transmitter).
Operation selector ON position	This position is for operating the air conditioner with the wireless remote control unit. Set the selector normally in this position.
OFF position  WARNING	Switch the selector to the OFF position if you are not going to use the air conditioner for a few days or longer. The OFF position does not disconnect the power. Use the main power switch to turn off power completely.
TEST position  CAUTION	This position is used only when servicing the air conditioner. Do not set at the TEST position for normal operation.
DEMO position	This position is used only when setting address of the remote control unit.
OPERATION lamp	This lamp lights when the system is in the continuous AUTO (red, orange or green), HEAT (red), DRY (orange) and COOL (green) mode.
TIMER lamp	This lamp lights when the system is being controlled by the timer.
SERVICE lamp	When a fault occurs in the air conditioner, this lamp turns on or flashes in combination with the other two lamps to indicate the type of fault.



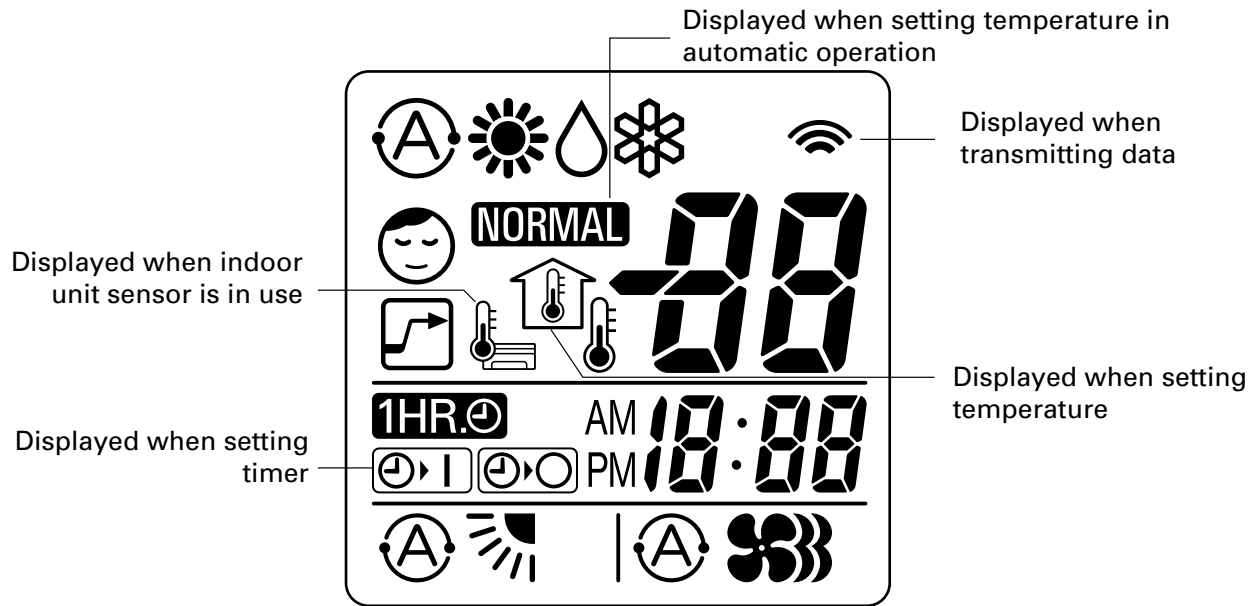

Remote Control Unit (Display)



EG

Symbols

(1) Operation mode

- AUTO 
- HEAT..... 
- DOUBLE SENSOR DRY 
- COOL 

(2) Confirmation of transmission





(3) Set temperature 16-30 °C

- When set to 28 °C.....
- Current temperature indication



(4) Timer

- ON Timer 
- OFF Timer 

1-hour OFF Timer

(5) ECONOMY



(6) High power operation



(7) Flap indication

Auto. flap indication.....



Flap angle indication

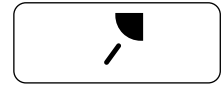

Sweep indication.....



(8) Fan speed

Automatic operation



HIGH



MEDIUM.....



LOW

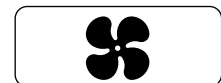



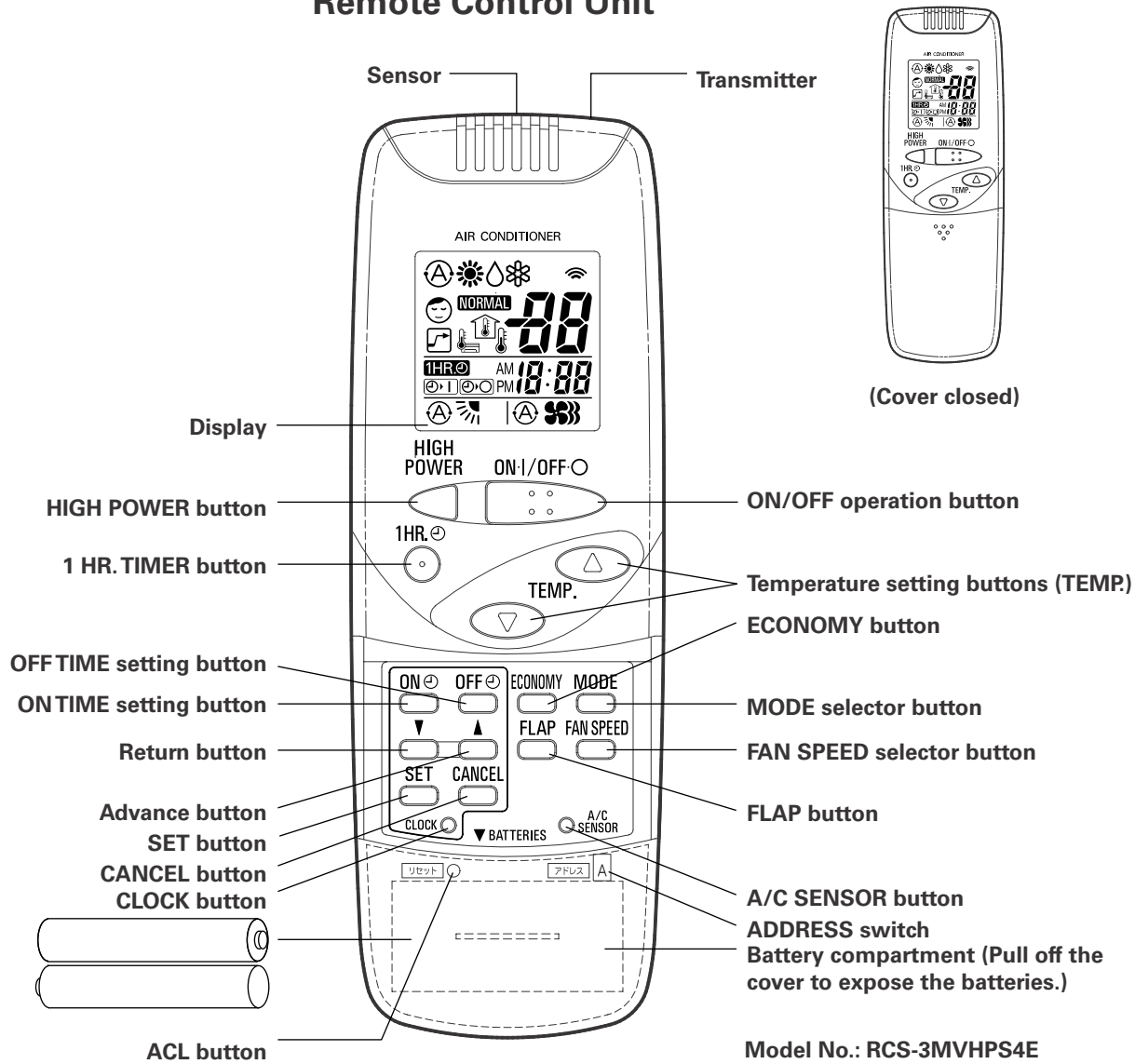

Remote Control Unit

















NOTE

The illustration above pictures the remote control unit after the cover has been lowered and removed.

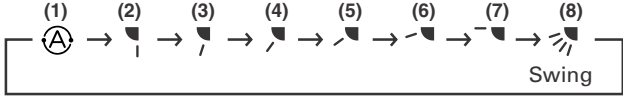
Transmitter	When you press the buttons on the remote control unit, the  mark appears in the display to transmit the setting changes to the receiver in the air conditioner.
Sensor	A temperature sensor inside the remote control unit senses the room temperature.
Display	Information on the operating conditions is displayed while the remote control unit is switched on. If the unit is turned off, only the mode that was set previously is still displayed.
HIGH POWER button	 : When you press this button, the current operation mode is set to the HIGH POWER mode, and the unit is operated in this mode for 15 minutes.
ON/OFF operation button	This button is for turning the air conditioner on and off.
1 HR. TIMER button (1-HOUR OFF TIMER)	1HR. : When you press this button, regardless of whether the unit is operating or stopping, the unit operates for one hour and then shuts down.
Temperature setting buttons (TEMP.)	Press the  button to increase the set temperature. Press the  button to reduce the set temperature. For details, see Automatic operation and Manual operation.

Remote Control Unit (continued)

<p>ONTIME/OFFTIME setting buttons</p>	<p>No display : The timer does not operate.</p> <p> : The air conditioner stops at the set time.</p> <p> : The air conditioner starts at the set time.</p> <p> : The air conditioner stops and starts, or starts and stops, at the set times every day. For details, see "Setting the Timer".</p>
<p>ECONOMY button</p>	<p>For details, see "ECONOMY Mode". When you press this button in the HEAT, DRY or COOL mode, the  mark appears in the display, and the remote control unit will automatically adjust the set temperature to save energy.</p>
<p>MODE selector button (AUTO)</p> <p>(HEAT)</p> <p>(DRY)</p> <p>(COOL)</p>	<p>Use this button to select AUTO, HEAT, DRY or COOL mode.</p> <p> : When this setting is selected, the air conditioner calculates the difference between the outdoor temperature and the room temperature and automatically switches to the "COOL", "DRY" or "HEAT" mode as appropriate.</p> <p> : The air conditioner makes the room warmer.</p> <p> : The air conditioner reduces the humidity in the room.</p> <p> : The air conditioner makes the room cooler.</p>
<p>FLAP button</p> <p>NOTE</p>	<p>Press this button either to select the setting of the airflow direction to the auto. flap in each mode or one of the six possible positions manually or to select the sweep function which moves the flap up and down automatically.</p> <p> : Auto flap setting: If selected in a heating operation, the flap is set to position (3) in the following chart. If selected in a cooling or dry operation, the flap is set at position (7) in the following chart.</p> <p> : The airflow direction can be set manually. (six positions)</p> <p> : The flap moves up and down automatically.</p> <p>When you press the FLAP button, the air flow direction will be changed one by one as follows.</p> <div style="text-align: center;">  <p>The diagram shows a sequence of eight flap positions labeled (1) through (8) connected by arrows. Position (1) is the auto flap icon. Position (8) is the sweep icon. The word "Swing" is written below the arrow between (7) and (8).</p> </div>
<p>FAN SPEED selector button</p>	<p> : The air conditioner automatically decides the fan speeds.</p> <p> : High fan speed</p> <p> : Medium fan speed</p> <p> : Low fan speed</p>
<p>ACL button (ALL CLEAR)</p>	<p>Puts the remote control unit into pre-operation status. Always press this button after replacing the batteries.</p>

EG

Remote Control Unit (continued)

ADDRESS switch	<ul style="list-style-type: none"> • Change the address switch to prevent mixing of signals from remote control units when two Sanyo air conditioners are installed next to each other. Normally, the address switch is set to A. When switching the address, take the steps listed below. Contact your dealer where you made the purchase if 3 or more Sanyo air conditioners are to be operated. ① Break off the address switching tabs on the remote control unit, and set the address switch to B. ② Insert batteries into the remote control unit, press the ACL button, and attach the cover. ③ Open the intake grille of the indoor unit, and set the operation knob to the DEMO position. ④ Press the ON/OFF operation button on the remote control unit, and check that a receiving tone (beep) is heard from the indoor unit. ⑤ Set the operation selector to the ON position, and close the intake grille. ⑥ Operate the remote control unit, and check that a receiving tone (beep) is heard from the indoor unit. <ul style="list-style-type: none"> • Normally, the tabs on the remote control unit should not be bent.
A/C SENSOR button	<p>When you press this button (use a small-tipped object such as a ballpoint pen), the  mark will appear at the display. And the room temperature is detected by the sensor which is built into the indoor unit and the air conditioner is controlled accordingly.</p> <p style="text-align: center;">NOTE</p> <p>If the remote control is located near a heat source, such as a space heater or in direct sunlight, press the A/C SENSOR button to switch to the sensor on the indoor unit.</p>

NOTE The remote control unit sends the temperature signal to the air conditioner regularly at five minute intervals. If the signal from the remote control unit stops for more than ten minutes due to the loss of the remote control unit or other trouble, the air conditioner will switch to the temperature sensor which is built into the indoor unit and control the room temperature. In these cases, the temperature around the remote control unit may differ from the temperature detected at the air conditioner's position.

Using the Remote Control Unit

How to Install Batteries

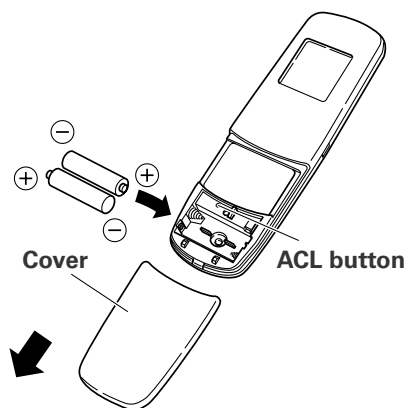

1. Slide the cover in the direction indicated by the arrow and remove it.
2. Install two AAA alkaline batteries. Make sure the batteries point in the direction marked in the battery compartment.
3. Use a thin object such as the tip of a pen to press the ACL button.

EG

NOTE

- The batteries last about six months, depending on how much you use the remote control unit. Replace the batteries when the remote control unit's display fails to indicate, or when the remote control cannot be used to change the air conditioner's settings.
- Use two fresh leak-proof type-AAA alkaline batteries.
- In replacing batteries, follow the instructions as mentioned in the sub-section "How to Install Batteries".
- If you do not use the remote control unit more than 1 month, take out the batteries.

How to Use the Remote Control Unit

When using the remote control unit, always point the unit's transmitter head directly at the air conditioner's receiver.

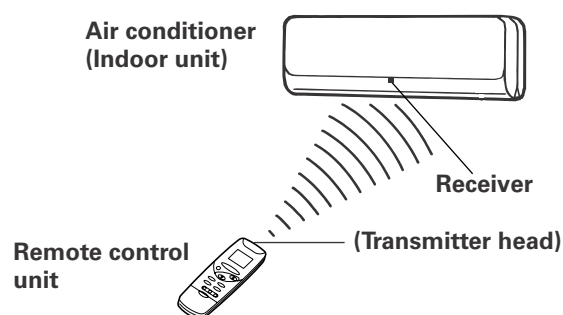

Operation with the Remote Control Unit

1. Automatic Operation

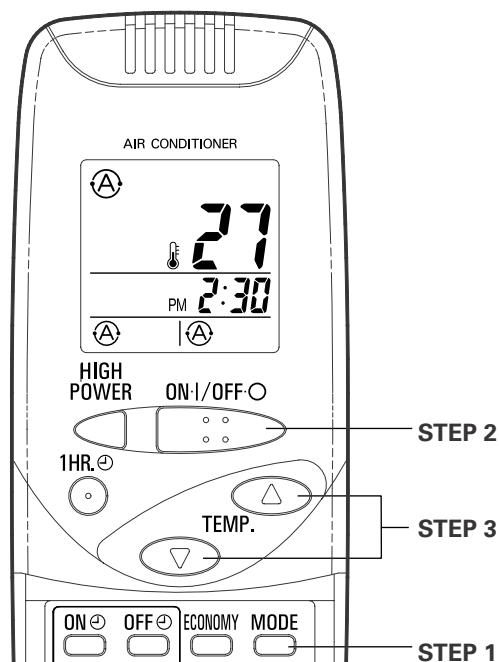

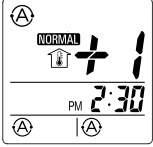
STEP 1	Press the MODE selector button and select A (AUTO).								
STEP 2	Press the ON/OFF button and switch the air conditioner ON.								
STEP 3	<p>Press the temperature setting buttons (TEMP.).</p> <p>The air conditioner starts operating after automatically selecting the type of operation—whether heating, drying (dehumidifying) or cooling—that suits the conditions in the room, and automatically adjusting the temperature, fan speed and airflow direction.</p> <p>Standard temperature settings during automatic operation</p> <table border="1"> <thead> <tr> <th>Type of operation</th> <th>Standard temperature setting</th> </tr> </thead> <tbody> <tr> <td>Heating</td> <td>24°C</td> </tr> <tr> <td>Drying</td> <td>20°C to 26°C range (The exact temperature depends on the prevailing temperature when the unit starts operating.)</td> </tr> <tr> <td>Cooling</td> <td>27°C</td> </tr> </tbody> </table> <p>Each time one of the temperature setting buttons (TEMP.) is pressed, the temperature is changed by 1°C.</p> <div style="display: flex; align-items: flex-start;"> <div style="margin-right: 20px;">  </div> <div> <p>The temperature can be changed from +4°C (higher) to -4°C (lower) from the standard temperature setting. (The upper limit during cooling is 30°C.)</p> </div> </div>	Type of operation	Standard temperature setting	Heating	24°C	Drying	20°C to 26°C range (The exact temperature depends on the prevailing temperature when the unit starts operating.)	Cooling	27°C
Type of operation	Standard temperature setting								
Heating	24°C								
Drying	20°C to 26°C range (The exact temperature depends on the prevailing temperature when the unit starts operating.)								
Cooling	27°C								

Operation with the Remote Control Unit (continued)

As shown in the figure below, the automatic selection of the operating modes is determined by the indoor temperature and outside air temperature.

		Indoor temperature			Temperature setting (standard)
		Approx. 15°C	Approx. 22°C	Approx. 27°C	
Outside air temperature	Approx. 22°C	Cooling operation			27°C
	Approx. 20°C				Drying operation
	Approx. 18°C	Heating operation			

EG

- When multiple indoor units are used and units in other rooms are already operating, they will be set to the same type of operation as the operating indoor units.
- The temperature, airflow direction and fan speed are set automatically but the airflow direction and fan speed can be changed to suit your individual preference. It will take a few seconds for the fan speed to be switched.

2. Manual Operation

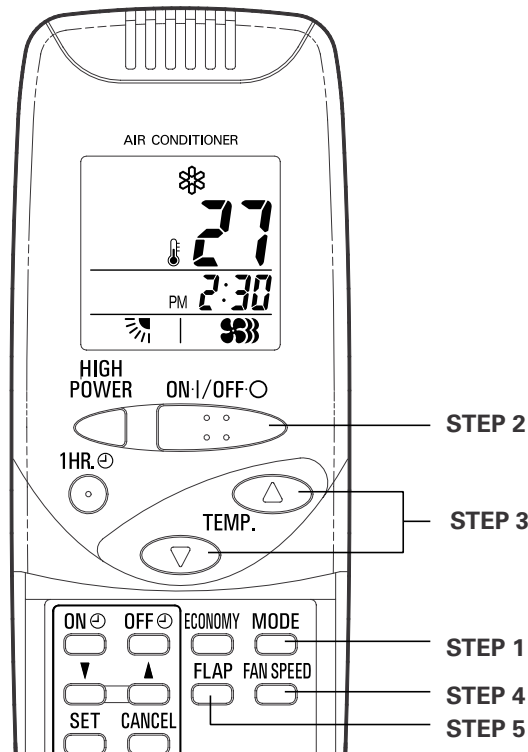

NOTE

Check that the circuit breaker on the power panel is turned on and that the operation selector of the indoor unit is in the ON position.

Operation with the Remote Control Unit (continued)

STEP 1	<p>Press the MODE selector button and select the desired mode.</p> <p>For heating operation → ☀ For dehumidifying operation → 💧 For cooling operation → ❄</p>							
STEP 2	To start the air conditioner, press the ON/OFF operation button.							
STEP 3	<p>Press the temperature setting buttons to change the temperature setting to the desired temperature.</p> <p>Adjustable temperature range: 30 °C max. 16 °C min.</p>							
NOTE	<ul style="list-style-type: none"> Room temperature control works to ensure that the temperature stabilizes within a range of ± 2 °C of the temperature setting. For this reason, the value displayed on the remote control unit may differ from the actual temperature setting. Before the temperature stabilizes, this difference may exceed the ± 2 °C range. The operating lamp of the indoor unit lights in one of the colors shown below. <table border="1" style="margin-left: auto; margin-right: auto;"> <tr> <td rowspan="3" style="padding: 5px;">Operating lamp</td> <td style="padding: 5px;">Heating</td> <td style="padding: 5px;">Red</td> </tr> <tr> <td style="padding: 5px;">Drying</td> <td style="padding: 5px;">Orange</td> </tr> <tr> <td style="padding: 5px;">Cooling</td> <td style="padding: 5px;">Green</td> </tr> </table>	Operating lamp	Heating	Red	Drying	Orange	Cooling	Green
Operating lamp	Heating		Red					
	Drying		Orange					
	Cooling	Green						
STEP 4	Set the FAN SPEED selector button to the setting you want. (Refer to "Adjusting the Airflow Direction" on page 23.)							
STEP 5	Press the FLAP button and set the airflow direction as desired. (Refer to "Adjusting the Airflow Direction" on page 23.)							





To stop the air conditioner, press the ON/OFF operation button again.

- After the cooling or drying operation has stopped, the indoor fan runs for about 30 seconds to dry out the inside of the air conditioner. (The operating lamps remain off.) The flap closes after the fan has stopped.
- If the room temperature rises above the temperature setting during a drying operation, the unit performs similar operation to cooling, and when the room temperature approaches the temperature setting, it performs the humidity-priority drying operation.
- The drying operation does not serve to raise the room temperature. (When the outside air temperature is low or when the heat quantity inside the room is low, the room temperature will not rise.)
- A change made to the temperature setting remains stored in the memory even after operation has stopped.
- If the temperature setting is lowered during a drying operation so that the unit has switched to a cooling operation, the outdoor unit shuts down for 3 minutes. (This happens only when one indoor unit is used.)
- When the unit is running in the drying operation mode while the temperature setting is higher than the room temperature, the humidity may not be reduced. In a case like this, select a temperature setting which is lower than the current room temperature, and perform the drying operation.

NOTE This appliance has a built-in 3-minute time delay circuit to ensure reliable operation. When the operation button is pressed, the compressor will start running within three minutes. In the event of power failure, the unit will stop.

Operation with the Remote Control Unit (continued)

3. Adjusting the Fan Speed

- A. Automatic** Simply set the FAN SPEED selector button to the  position.
- B. Manual** If you want to adjust fan speed manually during operation, just set the FAN SPEED selector button as desired. [, , or ]

EG

4. ECONOMY Mode

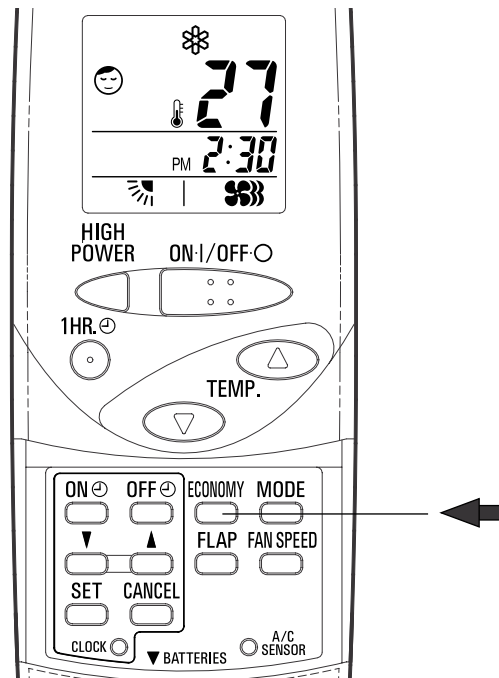

The ECONOMY Mode is used for saving energy.

Press the ECONOMY button while the air conditioner is operating. The  mark appears in the display.

To cancel the ECONOMY function, press the ECONOMY button again.

Operation with the Remote Control Unit (continued)

A. In Cooling and DRY Mode: (☼ and ◊)

When the ECONOMY mode is selected, the air conditioner automatically raises the temperature setting 1 °C when 60 minutes have passed after the selection was made. This enables you to save energy without sacrificing comfort. This function is convenient when gentle cooling is needed.

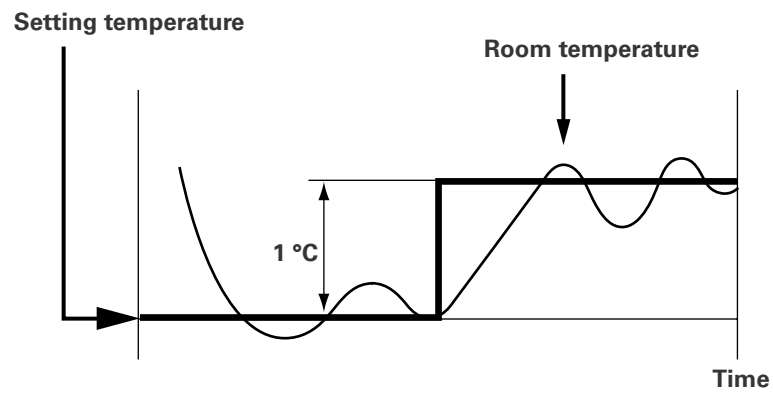

B. In Heating Mode: (☼)

When the ECONOMY mode is selected, the air conditioner automatically lowers the temperature setting 3 °C when 60 minutes have passed after the selection was made, and then another 4 °C after another 2 hours have passed, regardless of the indoor temperature when ECONOMY was selected. This enables you to save energy without sacrificing comfort. This function is convenient when gentle heating is needed.

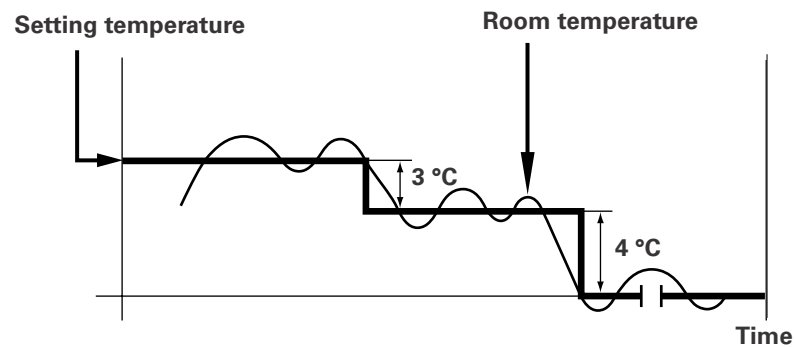

NOTE

The temperature does not shift in the Auto mode during ECONOMY mode.

Special Remarks

Power failure during operation

- In the event of power failure, the unit will stop. Though the power is resumed, the unit will not restart automatically. Press the ON/OFF operation button and restart the unit again.

Clicking Sound

Clicking sound is heard from the air conditioner

- In heating or cooling operation, any plastic parts may expand or shrink due to a sudden temperature change. In this event, a clicking sound may occur. This is normal, and the sound will soon disappear.

Remote Control Unit

- The remote control unit sends the setting condition to the air conditioner regularly at five minute intervals.

EG

Setting the Timer

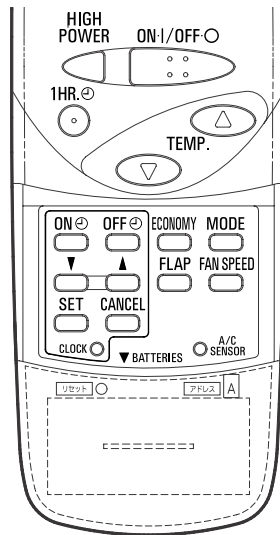

1. How to set the present time

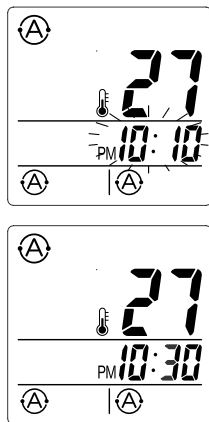

(Example) To set to 10:30 pm.

Operation	Indication
1. Press the CLOCK button three times.	The time indication alone blinks.
2. Press the Advance, Return (▲, ▼) button until PM 10:30 is displayed.	The time can be set in 1-minute increments. Holding down the button advances the time rapidly in 10-minute increments.
3. Press the CLOCK button again.	This completes the setting of the current time.

2. How to set the OFF time

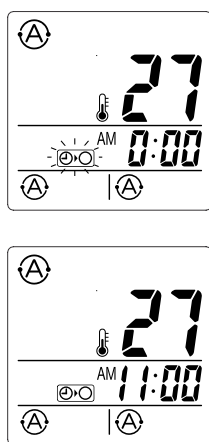

(Example) To stop the air conditioner at 11:00 am.

1. Press the OFFTIME setting button once.	The timer indication blinks and present OFF time is shown.
2. Press the Advance, Return (▲, ▼) button until AM 11:00 is displayed.	The time can be set in 10-minute increments. Holding down the button advances the time rapidly in 10-minute increments.
3. Press the SET button.	The timer indication stops blinking and the present time is displayed.

Setting the Timer (continued)

NOTE

- The timer can be programmed while the unit is operating or while it is stopped.
- A timer program is canceled after the timer has operated. So the timer should be set every time programming operation is to be performed.
- The airflow direction, fan speed and temperature setting can be changed after a timer program has been set even when the unit is stopped. Even when operation is stopped during an ON timer program, the unit will start operating when the set time is reached provided that the program is not canceled.
- As a safeguard to prevent you forgetting to turn off the air conditioner, the unit's operation will be stopped if the remote control unit has not been operated for at least 25 hours after the ON timer starts.
- When the ON timer is used, the temperature setting may not be reached by the set time depending on the size and conditions in the room.

EG



To cancel a timer program

- Press the CANCEL button.
- When either an ON or OFF timer is to be canceled, press the button corresponding to the timer whose program is to be canceled, and then press the CANCEL button.

3. How to set the ON time

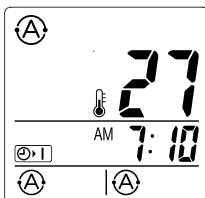
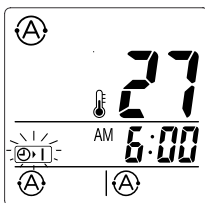
(Example) To start operation at 7:10 am.



Operation	Indication
1. Press the ON TIME setting button once.	The timer  indication blinks and present ON time is shown.
2. Press the Advance, Return (▲, ▼) button until AM 7:10 is displayed.	The time can be set in 10-minute increments. Holding down the button advances the time rapidly in 10-minute increments.
3. Press the SET button.	The timer  indication stops blinking and the present time is displayed.

NOTE

ON timer (comfort programming)

The unit starts operating automatically to attempt to change the temperature to the desired level by the set time. (The unit operates at the low fan speed from up to 60 minutes prior to the set time.)

OFF timer

The unit stops operating at the set time.

Setting the Timer (continued)

4. How to set DAILY ON/OFF REPEAT timer

(Example) To start operation at 7:10 am. and stop the air conditioner at 11:00 am.

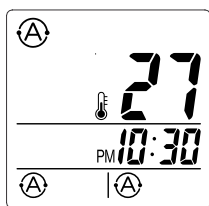

Present time

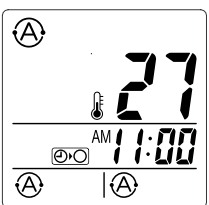
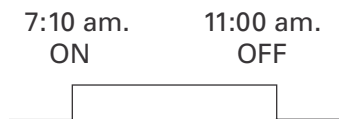

OFF time

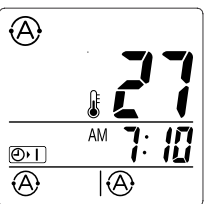

ON time

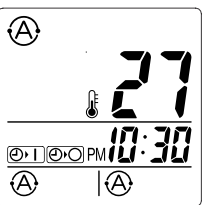

Daily ON/OFF

Operation	Indication
1. Set the timer ON/OFF times as shown in 2-1, 2, 3 and 3-1, 2, 3.	The present time 10:30 pm. and are displayed.

NOTE

- The ON/OFF combination timer uses the current time as the reference, and it is activated starting from whichever set time comes first.
- With the ON/OFF combination timer, the settings are repeated every day.
- You can check the timer ON/OFF times after you have set them by pressing the ONTIME and OFFTIME setting buttons.

Setting the 1-Hour OFF Timer

1. 1-Hour OFF Timer

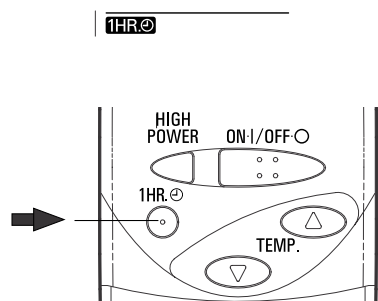

This function causes the unit to operate for one hour and then stop, regardless of whether the unit is on or off when this button is pressed. The **1HR** indicator in the display indicates that this function is operating.

Setting the 1-Hour OFF Timer:

Regardless of whether the unit is operating or stopped, press the 1 HR. TIMER button.

1HR appears in the display.

Cancelling the 1-Hour OFF Timer:

Press the ON/OFF operation button to turn the unit off, wait for the unit to stop operating, and then press the ON/OFF operation button again. The 1-Hour Timer function is now cancelled and the unit operates normally.

NOTE

If, while the 1-Hour Timer function is operating, the 1 HR. TIMER button is pressed once to cancel the function and then again, the unit continues to operate for one hour from that point in time and then stops.

2. Operation together with the DAILY ON/OFF REPEAT Timer

- The 1 Hour OFF Timer setting is given priority over the DAILY ON/OFF REPEAT setting.
- It is not possible to use the OFF Timer and 1-Hour OFF Timer together. Whichever function is set last takes precedence. If the 1 HR. TIMER button is pressed while the TIMER OFF function operates, the OFF Timer is cancelled and the unit will stop operating one hour later.

EG

Setting the HIGH POWER Operation

1. HIGH POWER Operation

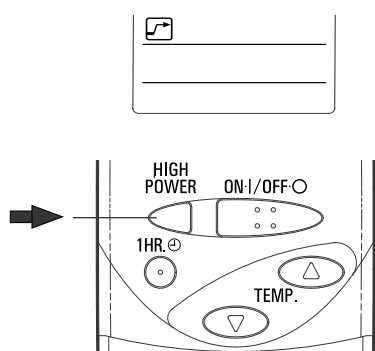

This function causes the unit to operate at HIGH POWER in the present mode of operation for 15 minutes when this button is pressed while the unit is on. The **HP** indicator on the display indicates that this function is operating.

Cancelling the HIGH POWER operation

HIGH POWER operation is canceled by pressing the ON/OFF operation button, HIGH POWER button (when it is pressed again) or MODE selector button, when the OFF time or HIGH POWER time setting is reached or when the ECONOMY mode operation is performed. The 15-minute timer is also cleared.

2. Operation together with the ECONOMY mode

It is not possible to use the HIGH POWER operation and ECONOMY mode operation together. Whichever function is set last takes precedence. If the HIGH POWER button is pressed while the ECONOMY mode is operating, the ECONOMY mode operation is cancelled and the unit will change to the HIGH POWER operation.

Setting the HIGH POWER Operation (continued)

NOTE

Concerning HIGH POWER operations

During a heating operation

- The room is heated for 15 minutes by warm air which has a slightly higher temperature than usual.
- When the HIGH POWER button is pressed during a defrosting operation, the unit enters the HIGH POWER operating mode upon completion of the defrosting operation.

When operating one indoor unit

During a cooling operation

- The room is cooled down for 15 minutes by cooling at a slightly lower temperature than usual, and the fan speed is set to the highest fan speed setting.

During a drying operation

- If the room temperature is higher than the temperature setting, the room is cooled down for 15 minutes by cooling at a slightly lower temperature than usual, and if it is close to the temperature setting, the drying operation is performed, and the fan speed is set to the highest fan speed setting.

When operating multiple indoor units

During a cooling or drying operation

- The room is cooled down for 15 minutes by cooling at a slightly lower temperature than usual, and the fan speed is set to the highest fan speed setting.
- When the unit is used continuously for 15 minutes, the temperature setting has been reached during a cooling or heating operation or the humidity setting has been reached during a drying operation (which is only when one indoor unit is operated), operation will continue for the next 5 minutes at a reduced power level, after which the regular operation is restored.
If the setting is not reached in either case, regular operation is restored immediately.
- After HIGH POWER operation has finished or when a HIGH POWER operation has been canceled on the way and then reinstated, regular operation is performed for about 5 minutes to protect the unit, and then the HIGH POWER operation is performed.
- During HIGH POWER operations, the room temperature may not coincide with the temperature setting.

Tips for Energy Saving

- Do not**
- **Block the air intake and outlet of the unit. If they are obstructed, the unit will not work well, and may be damaged.**
 - Let direct sunlight into the room. Use sunshades, blinds or curtains. If the walls and ceiling of the room are warmed by the sun, it will take longer to cool the room.
- Do**
- **Always try to keep the air filter clean. (Refer to "Care and Cleaning".) A clogged filter will impair the performance of the unit.**
 - To prevent conditioned air from escaping, keep windows, doors and any other openings closed.

Adjusting the Airflow Direction

EG

1. Horizontal

The horizontal airflow can be adjusted by moving the vertical vanes with your hands to the left or right.

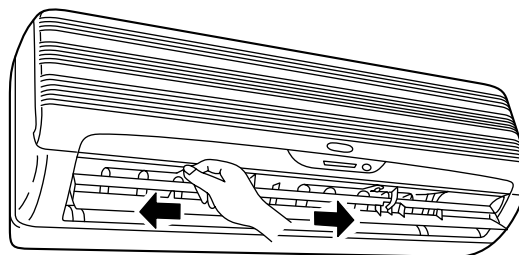

CAUTION

When the humidity is high, the vertical vanes should be in the front position during the cooling or dehumidifying operation. If the vertical vanes are positioned all of the way to the right or left, condensation may begin to form around the air vent and drip down.

2. Vertical

The vertical airflow can be adjusted by moving the flap with the remote control unit. Do not move the flap with your hands. Confirm that the remote control unit has been turned on. Use the FLAP button to set either the sweep function or one of the six airflow direction settings.

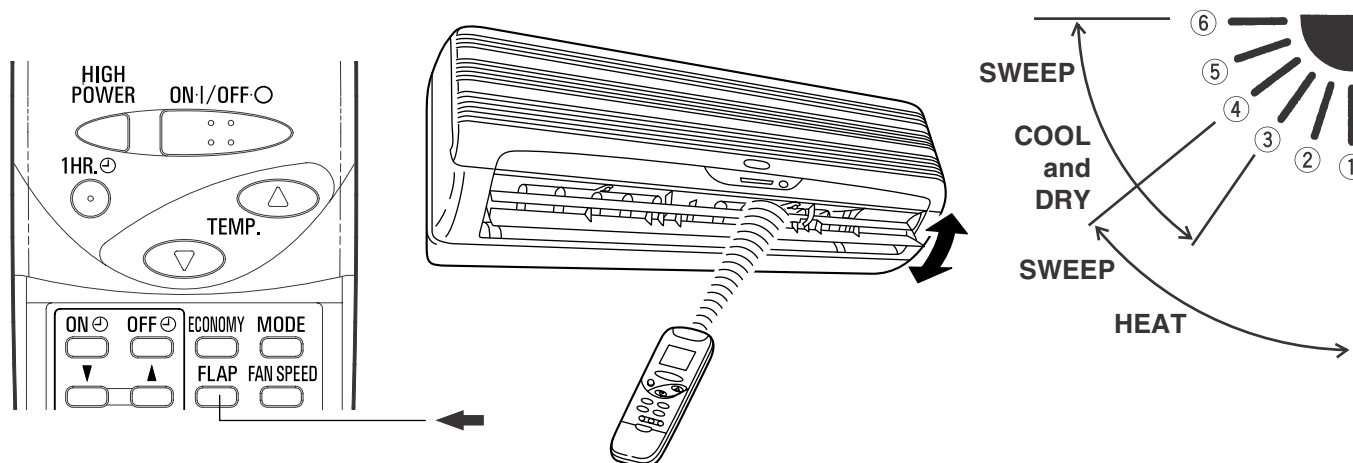

A. Sweep function



The flap starts moving up and down to deliver air over the sweep range.

B. Setting the airflow manually



Referring to the above illustration, use the FLAP button to set the airflow direction within the range used during the heating, cooling, or dehumidifying operation.

NOTE

- The flap automatically closes when the unit is off.
- During the heating operation, the fan speed will be very low and the flap will be in the horizontal position (position ⑥) until the air being blown out of the unit begins to warm. Once the air warms up, the flap position and fan speed change to the settings specified with the remote control.



CAUTION

- Use the FLAP button on the remote control to adjust the position of the flap. If you move the flap by hand, the actual flap position and the flap position on the remote control may no longer match. If this should happen, shut off the unit, wait for the flap to close, and then turn on the unit again; the flap position will now be normal again.
- Do not have the flap pointed down during cooling and drying operation. Condensation may begin to form around the air vent and drip down.

Operation without the Remote Control Unit

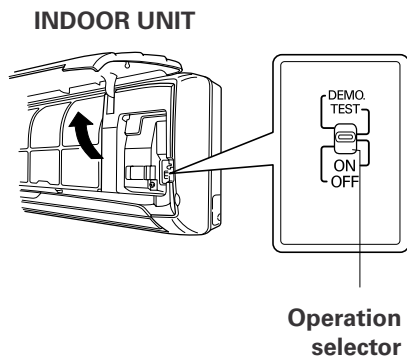

If you have lost the remote control unit or it has trouble, follow the steps below.

1. When the air conditioner is not running
If you want to turn on the air conditioner, switch the operation selector to the OFF position, and then to the ON position.

NOTE The set temperature and fan speed are automatically set at the last selection before stopping.

2. When the air conditioner is running
If you want to turn off the air conditioner, switch the operation selector to the OFF position.

Care and Cleaning



WARNING

1. For safety, be sure to turn the air conditioner off and also to disconnect the power before cleaning.
2. Do not pour water on the indoor unit to clean it. This will damage the internal components and cause an electric shock hazard.

Casing and Grille (Indoor Unit)

Clean the casing and grille of the indoor unit with a vacuum cleaner brush, or wipe them with a clean, soft cloth.

If these parts are stained, use a clean cloth moistened with a mild liquid detergent. When cleaning the grille, be careful not to force the vanes out of place.



CAUTION

1. Never use solvents, or harsh chemicals when cleaning the indoor unit. Do not wipe the plastic casing using very hot water.
2. Some metal edges and the fins are sharp and may cause injury if handled improperly; be especially careful when you clean these parts.
3. The internal coil and other components of the outdoor unit must be cleaned every year. Consult your dealer or service center.

Care and Cleaning (continued)

Anti-Mold Filter

The anti-mold filter behind the air intake grille should be checked and cleaned at least once every two weeks.

How to remove the anti-mold filter

1. Grasp both ends of the air intake grille and pull it out and up.
2. Push the anti-mold filter up slightly, and then pull it down.

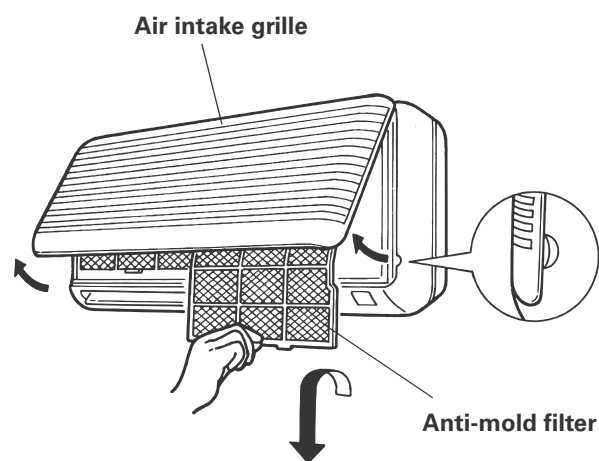

EG

Cleaning

Use a vacuum cleaner to remove light dust. If there is sticky dust on the filter, wash the filter in lukewarm, soapy water, rinse it in clean water, and dry it.

How to replace the anti-mold filter

1. With the "FRONT" mark facing you, slide the anti-mold filter up into the unit and then lower the handle into the groove on the unit.
2. After installing the anti-mold filter, press the locations marked by the arrows (↓) and close the air intake grille.

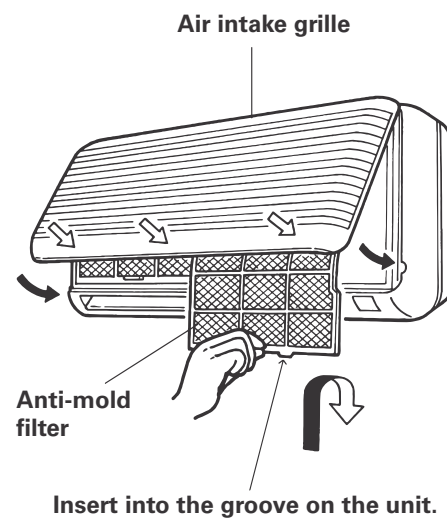

Care and Cleaning (continued)

Air Cleaning Filter

The air cleaning filter removes dust and dirt from the air, and reduces odors and smoke from tobacco.



WARNING

This air cleaning filter cannot remove harmful gases or vapors nor ventilate air in the room. You must open doors or windows frequently when you use gas or oil heating appliances. Otherwise there is a risk of suffocation in extreme cases.

How to install the air cleaning filter

The air cleaning filter needs to be installed behind the anti-mold filter.

1. Remove the anti-mold filter.
2. Install the air cleaning filter in the position shown in the figure.
3. Reinstall the anti-mold filter.

Air cleaning filter

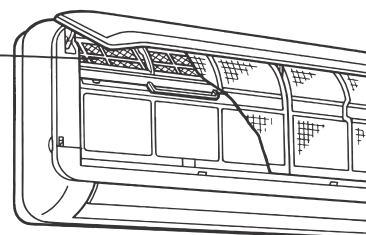

NOTE

- In general, the filter should be replaced once every three months.
- Dirty air clean filters cannot be washed and reused. Purchase a replacement filter at your local dealer.

Cleaning the main unit and remote control unit

- Wipe clean using a soft, dry cloth.
- To remove stubborn dirt, moisten a cloth in warm water no hotter than 40 °C, wring thoroughly, and then wipe.
- The air intake grille can be removed in order to wash it with water.

Removing and remounting the air intake grille

- With the air intake grille open all the way, grip both arms with your hands and pull toward you to remove. To remount, hold the air intake grille roughly horizontal and push it in until the arm shafts fit into the indentations in the main unit, then fit the grille into place.

Air intake grille

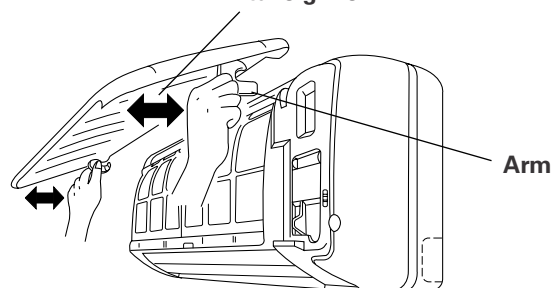

CAUTION

When using a footstool or the like, be careful not to let it tip over.

Washing the grille with water

- Clean the grille gently using a soft sponge, or the like. Then wipe away any remaining moisture.
- Neutral detergent may be used to remove stubborn dirt. Then rinse thoroughly with water and wipe away any remaining moisture.

Troubleshooting

If your air conditioner does not work properly, first check the following points before requesting service. If it still does not work properly, contact your dealer or service center.

Trouble	Possible Cause	Remedy
Air conditioner does not run at all.	<ol style="list-style-type: none"> 1. Power failure. 2. Leakage circuit breaker tripped. 3. Line voltage is too low. 4. Operation button is OFF. 5. Batteries in remote control unit have run down. 	<ol style="list-style-type: none"> 1. Restore power. 2. Contact service center. 3. Consult your electrician or dealer. 4. Press the button again. 5. Replace batteries.
OPERATION lamp blinks and air conditioner does not operate.	Trouble in wiring system.	Contact service center.
Compressor runs but soon stops.	Obstruction in front of condenser coil.	Remove obstruction.
Poor cooling (or heating) performance.	<ol style="list-style-type: none"> 1. Dirty or clogged air filter. 2. Heat source or many people in room. 3. Doors and/or windows are open. 4. Obstacle near air intake or air discharge port. 5. Thermostat is set too high for cooling (or too low for heating). 6. (Outdoor temperature is too low for heating.) 	<ol style="list-style-type: none"> 1. Clean air filter to improve airflow. 2. Eliminate heat source if possible. 3. Shut them to keep the heat (or cold) out. 4. Remove it to ensure good airflow. 5. Set the temperature lower (or higher). 6. (Consult your dealer or try to use a back-up heater.)
Clicking sound is heard from the air conditioner.	In heating or cooling operation, any plastic parts may expand or shrink due to a sudden temperature change. In this event, a clicking sound may occur.	This is normal, and the sound will soon disappear.
OPERATION lamp lights but outdoor unit will not run.	1. The use of cellular phones near the air conditioner may cause disturbance to its normal operation.	<ol style="list-style-type: none"> 1. Turn off the power then restart the air conditioner after 1 minute. 2. Consult your dealer.

EG

Operating Range

The air conditioner is operable within the temperature ranges as listed below:

	Temperature	Indoor air temperature	Outdoor air temperature
COOLING	Max.	32 °C DB / 23 °C WB	43 °C DB
	Min.	19 °C DB / 14 °C WB	19 °C DB
HEATING	Max.	27 °C DB / 19 °C WB	24 °C DB / 18 °C WB
	Min.	16 °C DB / -WB	- / -15 °C WB

