

TECHNICAL & SERVICE MANUAL

INDOOR UNIT : MPAF90MR5I
MPAF120MR5I
MPAF180R5I
MPAF240R5I



DC INVERTER MULTI-SYSTEM AIR CONDITIONER

Capacity	Indoor Model No.	
2.65 kW	MPAF90MR5I	
3.50 kW	MPAF120MR5I	
5.15 kW	MPAF180R5I	
7.10 kW	MPAF240R5I	

Wall Mounted Type Indoor Unit

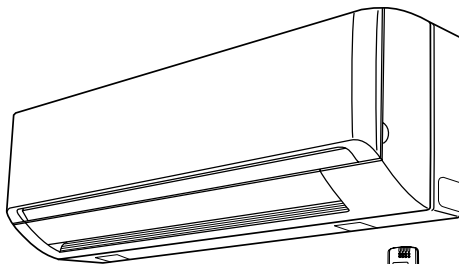

MPAF90MR5I
MPAF120MR5I

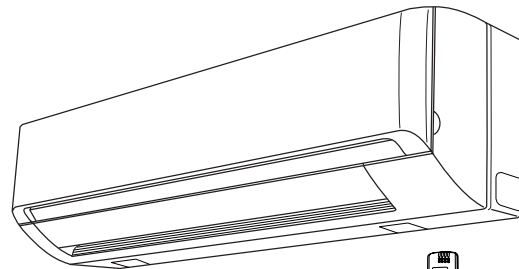

MPAF180R5I
MPAF240R5I



RoHS

- This product does not contain any hazardous substances prohibited by the **RoHS** Directive.

WARNING

- You are requested to use **RoHS** compliant parts for maintenance or repair.
- You are requested to use lead-free solder.

R410A

F-GAS REGULATION (EC) No 842 / 2006

Do not vent R410A into atmosphere : R410A is a fluorinated greenhouse gas, covered by Kyoto Protocol, with a Global Warming Potential (GWP) = 1975.

Important! Please Read Before Starting

This air conditioning system meets strict safety and operating standards. As the installer or service person, it is an important part of your job to install or service the system so it operates safely and efficiently.

For safe installation and trouble-free operation, you must:

- Carefully read this instruction booklet before beginning.
- Follow each installation or repair step exactly as shown.
- Observe all local, state, and national electrical codes.
- Pay close attention to all warning and caution notices given in this manual.



WARNING

This symbol refers to a hazard or unsafe practice which can result in severe personal injury or death.



CAUTION

This symbol refers to a hazard or unsafe practice which can result in personal injury or product or property damage.

If Necessary, Get Help

These instructions are all you need for most installation sites and maintenance conditions. If you require help for a special problem, contact our sales/service outlet or your certified dealer for additional instructions.

In Case of Improper Installation

The manufacturer shall in no way be responsible for improper installation or maintenance service, including failure to follow the instructions in this document.

SPECIAL PRECAUTIONS

WARNING When Wiring



ELECTRICAL SHOCK CAN CAUSE SEVERE PERSONAL INJURY OR DEATH. ONLY A QUALIFIED, EXPERIENCED ELECTRICIAN SHOULD ATTEMPT TO WIRE THIS SYSTEM.

- Do not supply power to the unit until all wiring and tubing are completed or reconnected and checked.
- Highly dangerous electrical voltages are used in this system. Carefully refer to the wiring diagram and these instructions when wiring. Improper connections and inadequate grounding can cause accidental injury or death.
- Ground the unit following local electrical codes.
- Connect all wiring tightly. Loose wiring may cause overheating at connection points and a possible fire hazard.
- Install a protective leakage breaker depending on the installation location (especially a damp or humid location). If a leakage breaker is not installed, electric shock can occur.

When Transporting

Be careful when picking up and moving the indoor and outdoor units. Get a partner to help, and bend your knees when lifting to reduce strain on your back. Sharp edges or thin aluminum fins on the air conditioner can cut your fingers.

When Installing

In a Ceiling or Wall

Make sure the ceiling/wall is strong enough to hold the unit's weight. It may be necessary to construct a strong wood or metal frame to provide added support.

In a Room

Properly insulate any tubing run inside a room to prevent "sweating" that can cause dripping and water damage to walls and floors.

In Moist or Uneven Locations

Use a raised concrete pad or concrete blocks to provide a solid, level foundation for the outdoor unit. This prevents water damage and abnormal vibration.

In an Area with High Winds

Securely anchor the outdoor unit down with bolts and a metal frame. Provide a suitable air baffle.

In a Snowy Area (for Heat Pump-type Systems)

Install the outdoor unit on a raised platform that is higher than drifting snow. Provide snow vents.

When Connecting Refrigerant Tubing

- Use the flare method for connecting tubing.
- Apply refrigerant lubricant to the matching surfaces of the flare and union tubes before connecting them, then tighten the nut with a torque wrench for a leak-free connection.
- Check carefully for leaks before starting the test run.

When Servicing

- Turn the power off at the main power box (mains) before opening the unit to check or repair electrical parts and wiring.
- Keep your fingers and clothing away from any moving parts.
- Clean up the site after you finish, remembering to check that no metal scraps or bits of wiring have been left inside the unit being serviced.

Others



CAUTION

- Ventilate any enclosed areas when installing or testing the refrigeration system. Escaped refrigerant gas, on contact with fire or heat, can produce dangerously toxic gas.
- Confirm upon completing installation that no refrigerant gas is leaking. If escaped gas comes in contact with a stove, gas water heater, electric room heater or other heat source, it can produce dangerously toxic gas.

Table of Contents

	Page
■ APPLICABLE MULTI-OUTDOOR UNITS	4
1. OPERATING RANGE	5
2. SPECIFICATIONS	
2-1. Unit Specifications	6
2-2. Major Component Specifications	11
2-3. Other Component Specifications	16
3. DIMENSIONAL DATA	17
4. REFRIGERANT FLOW DIAGRAM	
4-1. Refrigerant Flow Diagram	19
5. PERFORMANCE DATA	
5-1. Air Throw Distance Charts	20
6. ELECTRICAL DATA	
6-1. Electric Wiring Diagrams	25
7. FUNCTIONS	
7-1. Operation Functions	27
7-2. Protective Functions	29
8. TROUBLESHOOTING	
8-1. Precautions before Performing Inspection or Repair	30
8-2. Method of Self-Diagnostics	30
8-3. Checking the Indoor and Outdoor Units	32
8-4. Trouble Diagnosis of Fan Motor	33
8-5. Noise Malfunction and Electromagnetic Interference	34

1. OPERATING RANGE

	Temperature	Indoor Air Intake Temp.	Outdoor Air Intake Temp.
Cooling	Maximum	32 °C D.B. / 23 °C W.B.	43 °C D.B.
	Minimum	19 °C D.B. / 14 °C W.B.	- 5 °C D.B. (*1)
Heating	Maximum	27 °C D.B.	24 °C D.B. / 18 °C W.B.
	Minimum	16 °C D.B.	- D.B. / - 15 °C W.B.

(*1) 0 °C D.B. : When combined with MPAF180R5I-MPAF240R5I

Indoor Unit **MPAF90MR5I**

Type		Wall Mounted Type Indoor Unit	
Power Source		220 to 240V Single-Phase 50Hz	
Voltage Rating		230V	
Performance		Cooling	Heating
Capacity	kW	2.65	3.6
	BTU/h	9,000	12,300
Air Circulation (High)		m ³ /h	460
Moisture Removal (High)		Liters/h	-
Electrical Rating		Cooling	Heating
Available Voltage Range	V	198 to 264	
Running Amperes	A	0.15	0.15
Power Input	W	35	35
Features			
Controls / Temperature Control		Microprocessor / I.C. Thermister	
Control Unit		Wireless Remote Control Unit	
Timer		24-Hour ON or OFF Timer, 1-Hour OFF Timer	
Fan Speeds		Indoor Auto and 3 steps	
Airflow Direction (Indoor)		Horizontal Manual Vertical Auto	
Air Filter		Washable, Anti-Mold	
Refrigerant		R410A	
Operation Sound	Indoor : Hi/Me/Lo/Qt* (*Qt = Quiet mode)	dB-A 34 / 31 / 28 / 22 34 / 31 / 28 / 22	
Refrigerant Tubing Connections		Flare Type	
Refrigerant	Narrow tube	mm (in.) 6.35 (1/4)	
Tube Diameter	Wide tube	mm (in.) 9.52 (3/8)	
Refrigerant Tube Kit / Accessories		Optional / Air Clean Filter	
Dimensions & Weight		Indoor Unit	
Unit Dimensions	Height	mm 285	
	Width	mm 825	
	Depth	mm 213	
Package Dimensions	Height	mm 270	
	Width	mm 900	
	Depth	mm 350	
Weight	Net	kg 10.0	
	Shipping	kg 12.0	
Shipping Volume		m ³ 0.08	

DATA SUBJECT TO CHANGE WITHOUT NOTICE.

Indoor Unit **MPAF120MR5I**

Type		Wall Mounted Type Indoor Unit	
Power Source		220 to 240V Single-Phase 50Hz	
Voltage Rating		230V	
Performance		Cooling	Heating
Capacity	kW	3.5	4.2
	BTU/h	11,900	14,300
Air Circulation (High)		m³/h	480
Moisture Removal (High)		Liters/h	2.0
			-
Electrical Rating		Cooling	Heating
Available Voltage Range	V	198 to 264	
Running Amperes	A	0.15	0.15
Power Input	W	35	35
Features			
Controls / Temperature Control		Microprocessor / I.C. Thermister	
Control Unit		Wireless Remote Control Unit	
Timer		24-Hour ON or OFF Timer, 1-Hour OFF Timer	
Fan Speeds		Indoor Auto and 3 steps	
Airflow Direction (Indoor)		Horizontal Manual	
		Vertical Auto	
Air Filter		Washable, Anti-Mold	
Refrigerant		R410A	
Operation Sound	Indoor : Hi/Me/Lo/Qt* dB-A	36 / 33 / 29 / 25	34 / 31 / 29 / 25
(*Qt = Quiet mode)			
Refrigerant Tubing Connections		Flare Type	
Refrigerant	Narrow tube mm (in.)	6.35 (1/4)	
Tube Diameter	Wide tube mm (in.)	9.52 (3/8)	
Refrigerant Tube Kit / Accessories		Optional / Air Clean Filter	
Dimensions & Weight		Indoor Unit	
Unit Dimensions	Height	mm	285
	Width	mm	825
	Depth	mm	213
Package Dimensions	Height	mm	270
	Width	mm	900
	Depth	mm	350
Weight	Net	kg	10.0
	Shipping	kg	12.0
Shipping Volume		m³	0.08

DATA SUBJECT TO CHANGE WITHOUT NOTICE.

Indoor Unit **MPAF180R5I**

Type		Wall Mounted Type Indoor Unit	
Power Source		220 to 240V Single-Phase 50Hz	
Voltage Rating		230V	
Performance		Cooling	Heating
Capacity	kW	5.15	6.0
	BTU/h	17,600	20,500
Air Circulation (High)		m³/h	840
Moisture Removal (High)		Liters/h	-
Electrical Rating		Cooling	Heating
Available Voltage Range	V	198 to 264	
Running Amperes	A	0.29	0.29
Power Input	W	32	32
Features			
Controls / Temperature Control		Microprocessor / I.C. Thermister	
Control Unit		Wireless Remote Control Unit	
Timer		24-Hour ON or OFF Timer, 1-Hour OFF Timer	
Fan Speeds		Indoor Auto and 3 steps	
Airflow Direction (Indoor)		Horizontal Manual Vertical Auto	
Air Filter		Washable, Anti-Mold	
Refrigerant		R410A	
Operation Sound	Indoor : Hi/Me/Lo/Qt* (*Qt = Quiet mode)	dB-A 41 / 38 / 34 / 28 40 / 37 / 34 / 28	
Refrigerant Tubing Connections		Flare Type	
Refrigerant	Narrow tube	mm (in.) 6.35 (1/4)	
Tube Diameter	Wide tube	mm (in.) 12.7 (1/2)	
Refrigerant Tube Kit / Accessories		Optional / Air Clean Filter	
Dimensions & Weight		Indoor Unit	
Unit Dimensions	Height	mm 298	
	Width	mm 1,065	
	Depth	mm 234	
Package Dimensions	Height	mm 302	
	Width	mm 1,140	
	Depth	mm 379	
Weight	Net	kg 12.0	
	Shipping	kg 15.0	
Shipping Volume		m³ 0.13	

DATA SUBJECT TO CHANGE WITHOUT NOTICE.

Indoor Unit **MPAF240R5I**

Type		Wall Mounted Type Indoor Unit	
Power Source		220 to 240V Single-Phase 50Hz	
Voltage Rating		230V	
Performance		Cooling	Heating
Capacity	kW	7.1	8.5
	BTU/h	24,200	29,000
Air Circulation (High)		m³/h	890
Moisture Removal (High)		Liters/h	2.3
			-
Electrical Rating		Cooling	Heating
Available Voltage Range	V	198 to 264	
Running Amperes	A	0.32	0.32
Power Input	W	36	36
Features			
Controls / Temperature Control		Microprocessor / I.C. Thermister	
Control Unit		Wireless Remote Control Unit	
Timer		24-Hour ON or OFF Timer, 1-Hour OFF Timer	
Fan Speeds		Indoor Auto and 3 steps	
Airflow Direction (Indoor)		Horizontal Manual Vertical Auto	
Air Filter		Washable, Anti-Mold	
Refrigerant		R410A	
Operation Sound	Indoor : Hi/Me/Lo/Qt* dB-A	44 / 41 / 38 / 30	43 / 40 / 37 / 30
(*Qt = Quiet mode)			
Refrigerant Tubing Connections		Flare Type	
Refrigerant	Narrow tube mm (in.)	6.35 (1/4)	
Tube Diameter	Wide tube mm (in.)	15.88 (5/8)	
Refrigerant Tube Kit / Accessories		Optional / Air Clean Filter	
Dimensions & Weight		Indoor Unit	
Unit Dimensions	Height	mm	298
	Width	mm	1,065
	Depth	mm	234
Package Dimensions	Height	mm	302
	Width	mm	1,140
	Depth	mm	379
Weight	Net	kg	12.0
	Shipping	kg	15.0
Shipping Volume		m³	0.13

DATA SUBJECT TO CHANGE WITHOUT NOTICE.

Indoor Unit **MPAF90MR5I**

Control PCB		
Part No.		CB-KMRV96EH
Controls		Microprocessor
Control Circuit Fuse		250V 3.15A
Remote Control Unit		RCS-6MHVPUS4E
Fan		
Type		Cross-Flow
Q'ty ... Dia. and Length	mm	1 ... D94 / L634
Fan Motor		
Type		DC Motor
Model ... Q'ty		SIC-39CVL-D847-4 ... 1
No. of Poles		8
Rough Measure RPM (Cool / Heat)		1,100 / 1,100
Nominal Output	W	47
Coil Resistance (Ambient Temp. 20 °C)	Ohm	-
Safety Device		
Type		Internal Controller
Over- Current Protection		Yes
Over-Heat Protection		Yes
Run Capacitor	Micro F	-
	VAC	-
Flap Motor		
Type		Stepping Motor
Model		24BYJ48-962
Rating		DC 12V
Coil Resistance (Ambient Temp. 25 °C)	Ohm	Each Pair of Terminal : 400 +/- 7%
Heat Exchanger Coil		
Coil		Aluminum Plate Fin / Copper Tube
Rows		2
Fin Pitch	mm	1.3
Face Area	m ²	0.188

DATA SUBJECT TO CHANGE WITHOUT NOTICE.

Indoor Unit **MPAF120MR5I**

Control PCB		
Part No.		CB-KMRV126EH
Controls		Microprocessor
Control Circuit Fuse		250V 3.15A
Remote Control Unit		RCS-6MHVPUS4E
Fan		
Type		Cross-Flow
Q'ty ... Dia. and Length	mm	1 ... D94 / L634
Fan Motor		
Type		DC Motor
Model ... Q'ty		SIC-39CVL-D847-4 ... 1
No. of Poles		8
Rough Measure RPM (Cool / Heat)		1,150 / 1,150
Nominal Output	W	47
Coil Resistance (Ambient Temp. 20 °C)	Ohm	-
Safety Device		
Type		Internal Controller
Over- Current Protection		Yes
Over-Heat Protection		Yes
Run Capacitor	Micro F	-
	VAC	-
Flap Motor		
Type		Stepping Motor
Model		24BYJ48-962
Rating		DC 12V
Coil Resistance (Ambient Temp. 25 °C)	Ohm	Each Pair of Terminal : 400 +/- 7%
Heat Exchanger Coil		
Coil		Aluminum Plate Fin / Copper Tube
Rows		2
Fin Pitch	mm	1.3
Face Area	m ²	0.188

DATA SUBJECT TO CHANGE WITHOUT NOTICE.

Indoor Unit **MPAF180R5I**

Control PCB		
Part No.		CB-KRV186EH
Controls		Microprocessor
Control Circuit Fuse		250V 3.15A
Remote Control Unit		RCS-6MHVPUSW4E
Fan		
Type		Cross-Flow
Q'ty ... Dia. and Length	mm	1 ... D94 / L845
Fan Motor		
Type		DC Motor
Model ... Q'ty		SIC-39CVL-D847-2 ... 1
No. of Poles		8
Rough Measure RPM (Cool / Heat)		1,200 / 1,200
Nominal Output	W	30
Coil Resistance (Ambient Temp. 20 °C)	Ohm	-
Safety Device		
Type		Internal Controller
Over- Current Protection		Yes
Over-Heat Protection		Yes
Run Capacitor	Micro F	-
	VAC	-
Flap Motor		
Type		Stepping Motor
Model		MP24Z3
Rating		DC 12V
Coil Resistance (Ambient Temp. 25 °C)	Ohm	Each Pair of Terminal : 400 +/- 7%
Heat Exchanger Coil		
Coil		Aluminum Plate Fin / Copper Tube
Rows		2
Fin Pitch	mm	1.3
Face Area	m ²	0.285

DATA SUBJECT TO CHANGE WITHOUT NOTICE.

Indoor Unit **MPAF240R5I**

Control PCB	
Part No.	CB-KRV246EH
Controls	Microprocessor
Control Circuit Fuse	250V 3.15A
Remote Control Unit	
RCS-6MHVPUSW4E	
Fan	
Type	Cross-Flow
Q'ty ... Dia. and Length	mm 1 ... D94 / L845
Fan Motor	
Type	DC Motor
Model ... Q'ty	SIC-39CVL-D847-2 ... 1
No. of Poles	8
Rough Measure RPM (Cool / Heat)	1,250 / 1,250
Nominal Output	W 30
Coil Resistance	Ohm -
(Ambient Temp. 20 °C)	
Safety Device	
Type	Internal Controller
Over- Current Protection	Yes
Over-Heat Protection	Yes
Run Capacitor	Micro F -
	VAC -
Flap Motor	
Type	Stepping Motor
Model	MP24Z3
Rating	DC 12V
Coil Resistance	Ohm Each Pair of Terminal : 400 +/- 7%
(Ambient Temp. 25 °C)	
Heat Exchanger Coil	
Coil	Aluminum Plate Fin / Copper Tube
Rows	2
Fin Pitch	mm 1.3
Face Area	m ² 0.285

DATA SUBJECT TO CHANGE WITHOUT NOTICE.

2-3. Other Component Specifications

Sensor Name	Model No. of sensor	Quantity of Sensor				
			MPAF90M	MPAF120M	MPAF180	MPAF240
Indoor air temp sensor	DTN-TKS451S	1	1	1	0	0
	1FA4V2E 042600 TH2	0	0	0	1	1

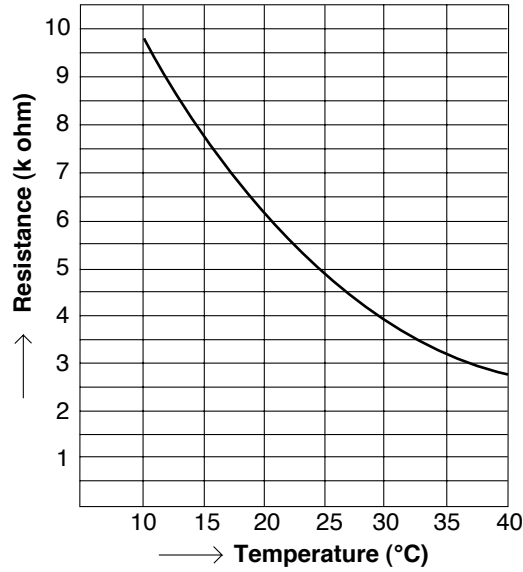

Sensor Name	Model No. of sensor	Quantity of Sensor				
			MPAF90M	MPAF120M	MPAF180	MPAF240
Indoor heat exchanger sensor	DTN-TKS451S	1	1	1	0	0
	1FA4V2E 042600 TH1	0	0	0	1	1

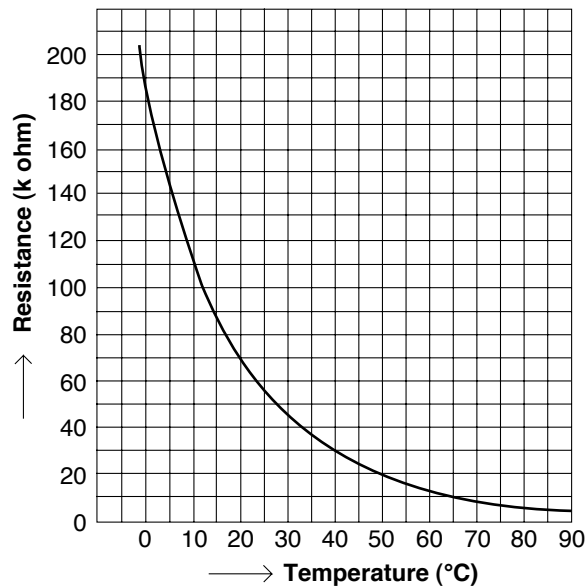

3. DIMENSIONAL DATA

Indoor Unit **MPAF90MR5I**
MPAF120MR5I

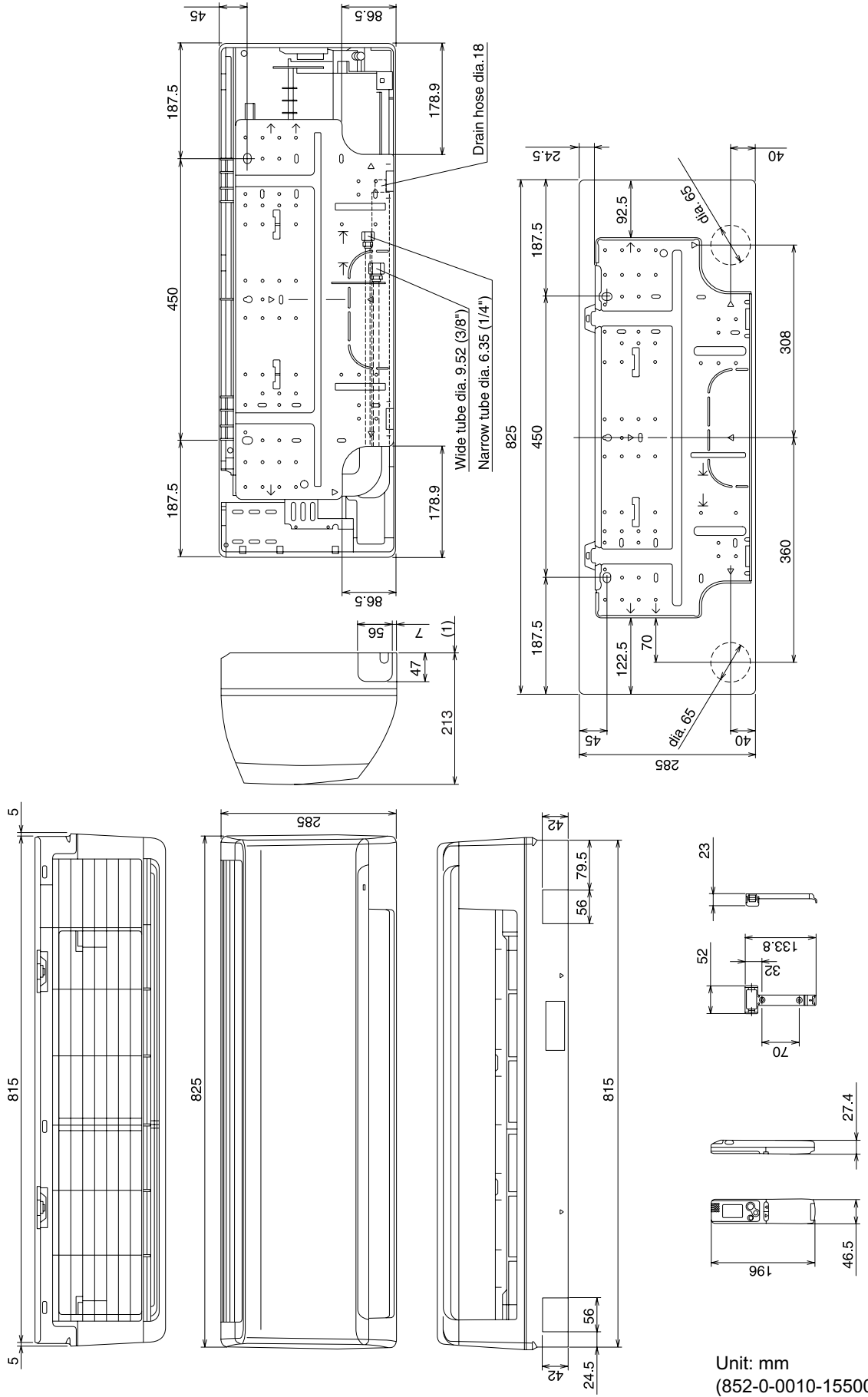

Unit: mm
(852-0-0010-15500-0)

Indoor Unit **MPAF180R5I**
MPAF240R5I

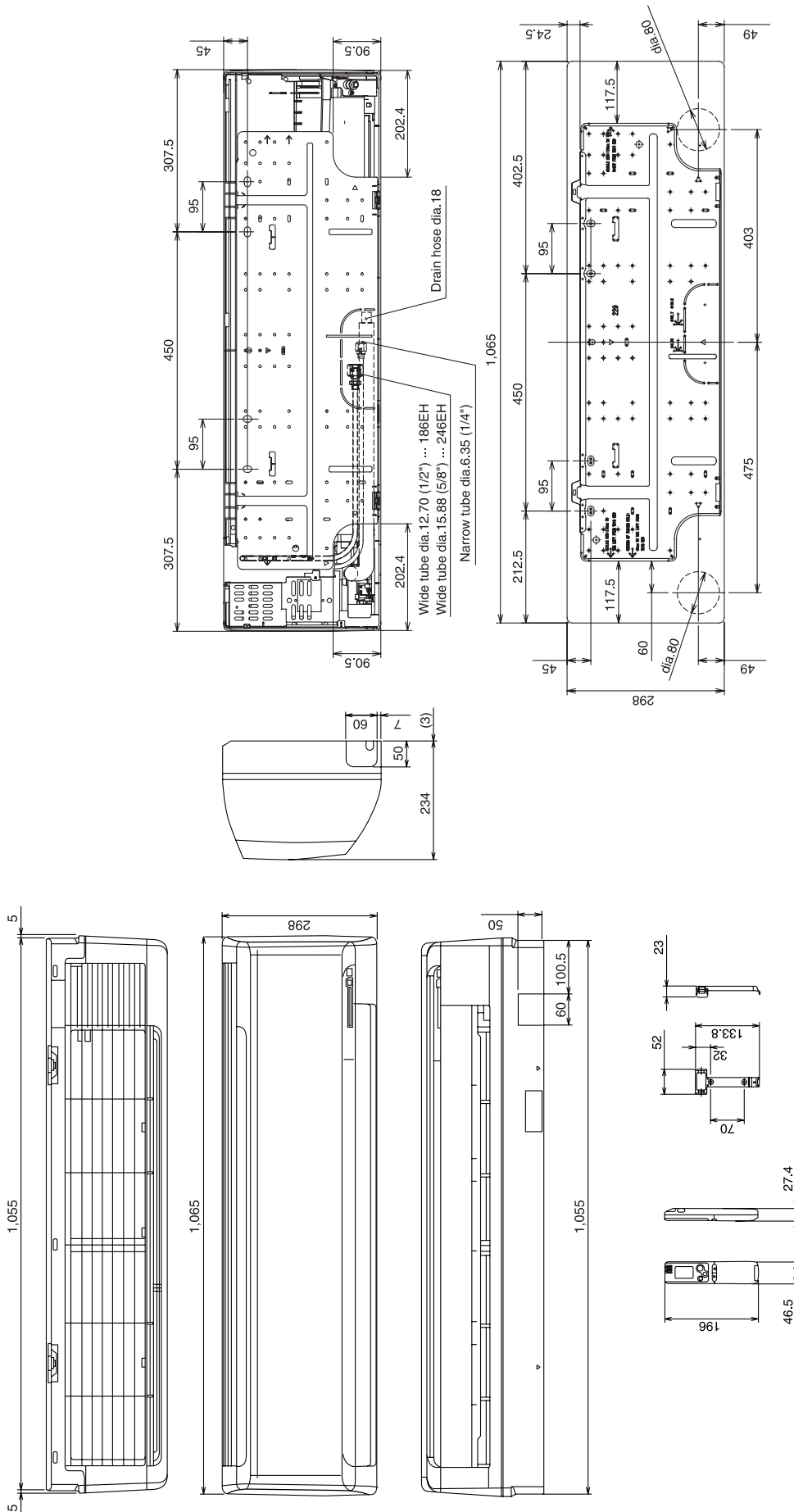

Unit: mm
(852-0-0010-16200-0)

4. REFRIGERANT FLOW DIAGRAM

4-1. Refrigerant Flow Diagram

Indoor Unit **MPAF90MR5I**
MPAF120MR5I

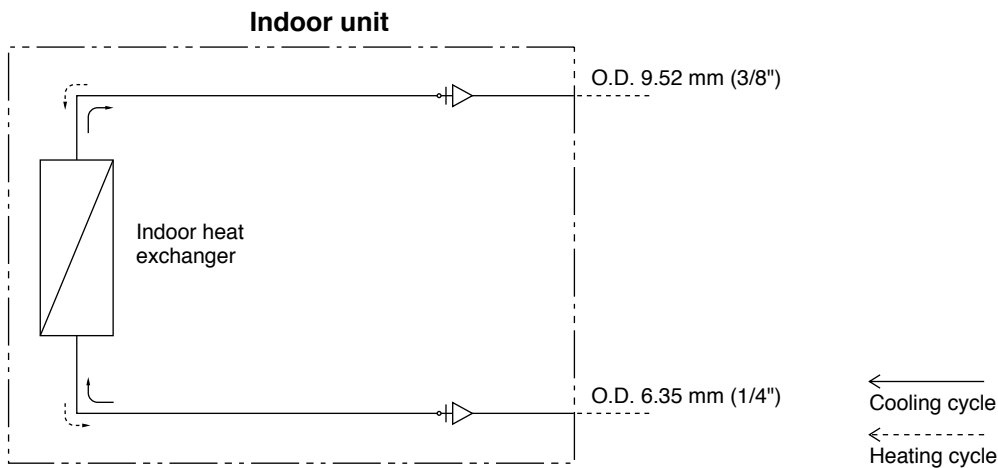

Indoor Unit **MPAF180R5I**

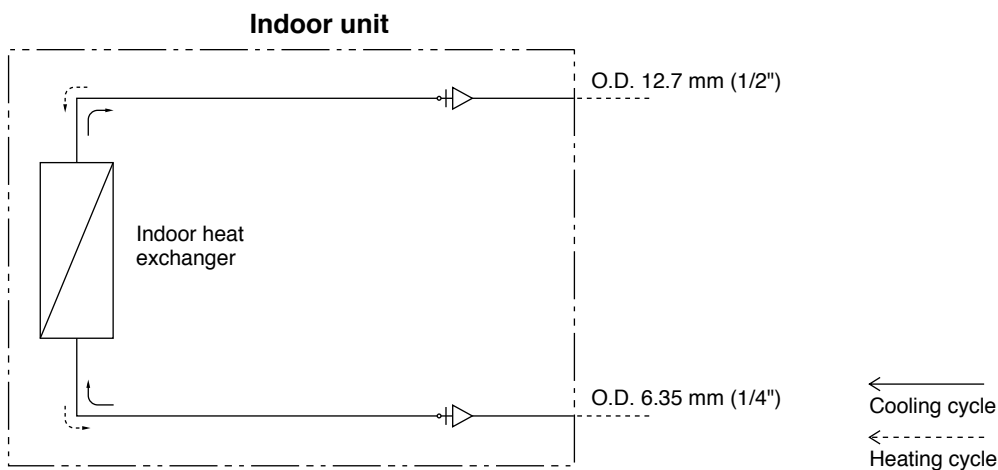

Indoor Unit **MPAF240R5**

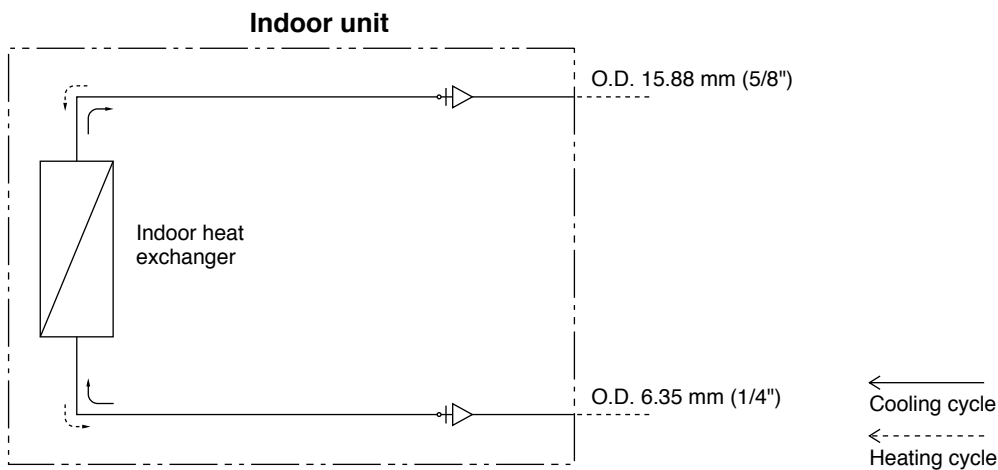

Cooling

Room air temp. : 27°C
 Fan speed : High

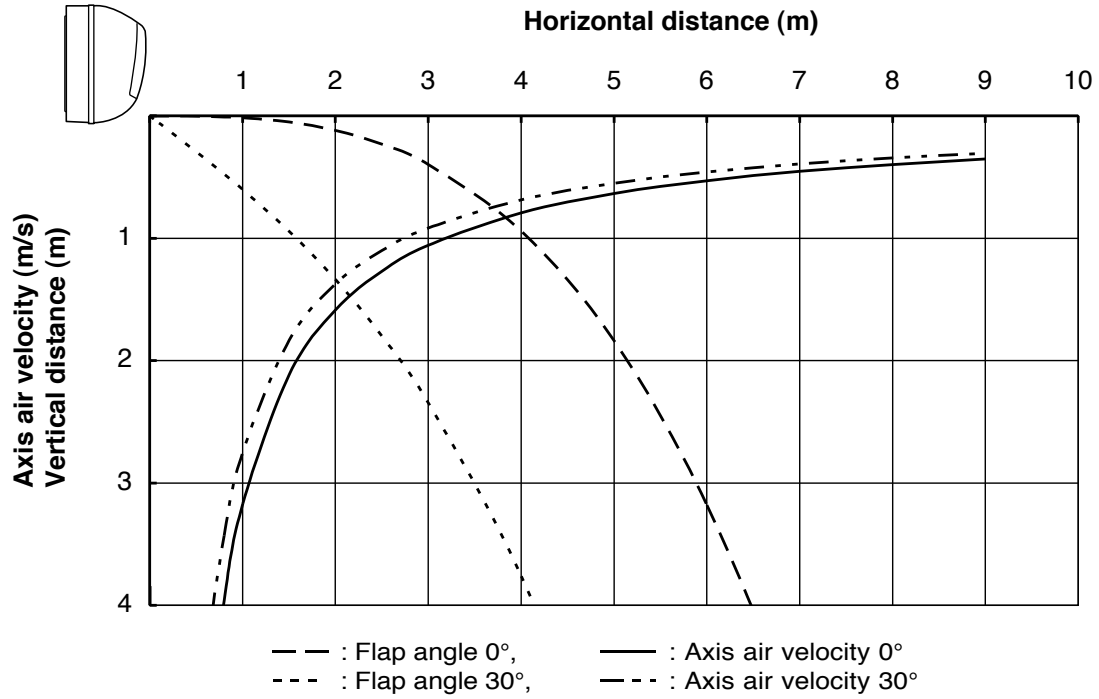

Heating

Room air temp. : 20°C
 Fan speed : High

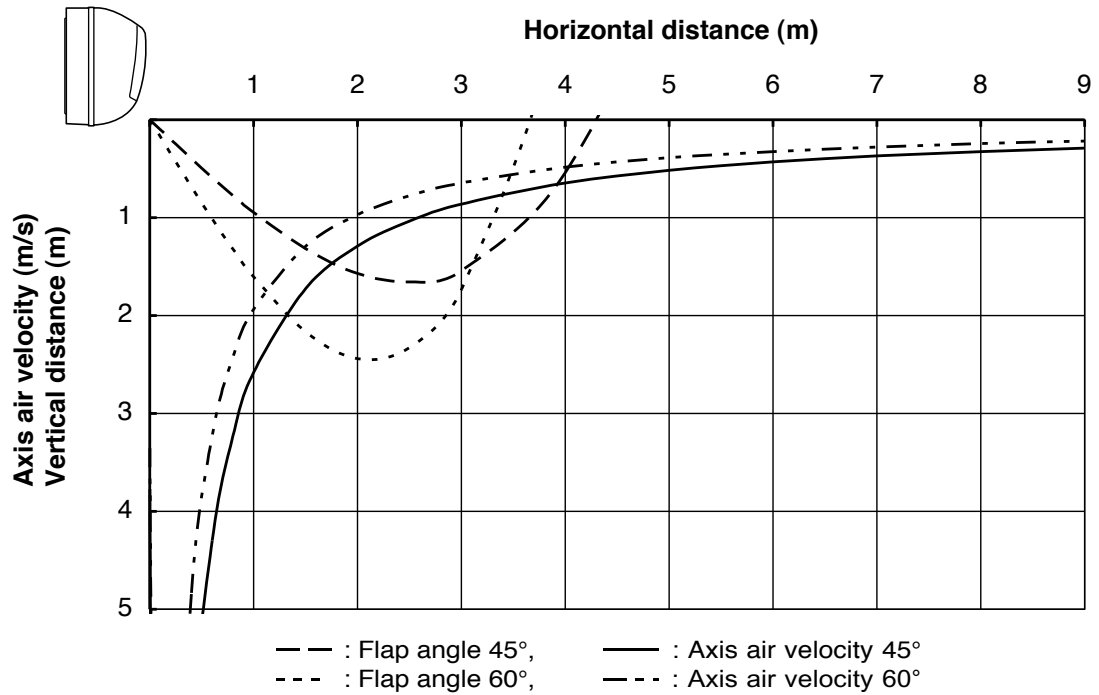

Cooling

Room air temp. : 27°C
 Fan speed : High

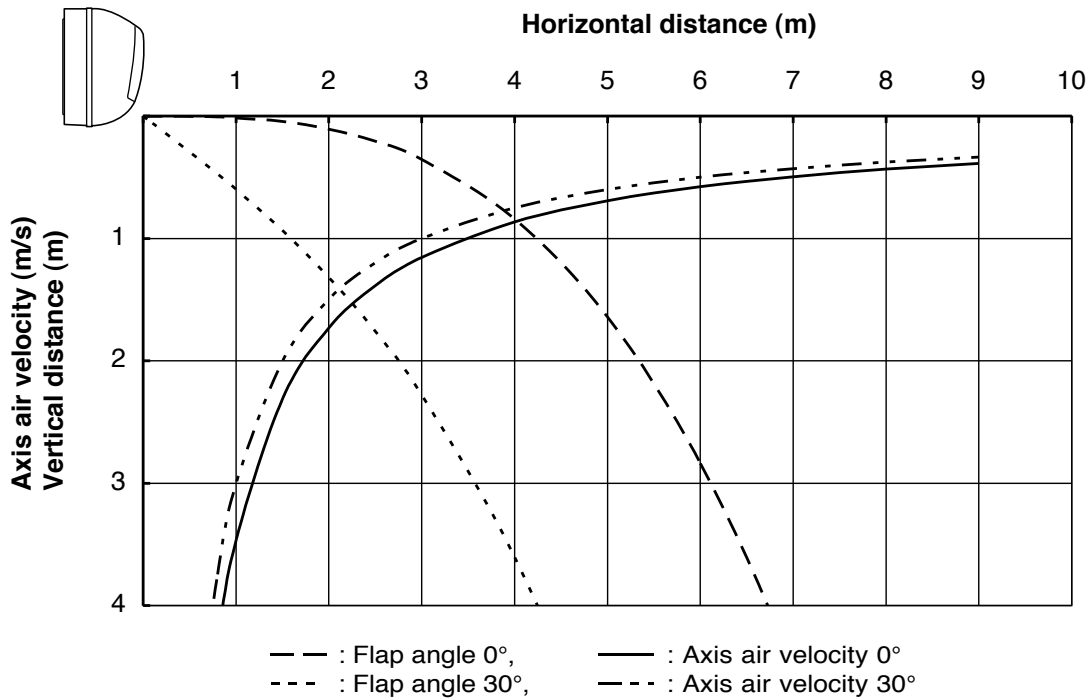

Heating

Room air temp. : 20°C
 Fan speed : High

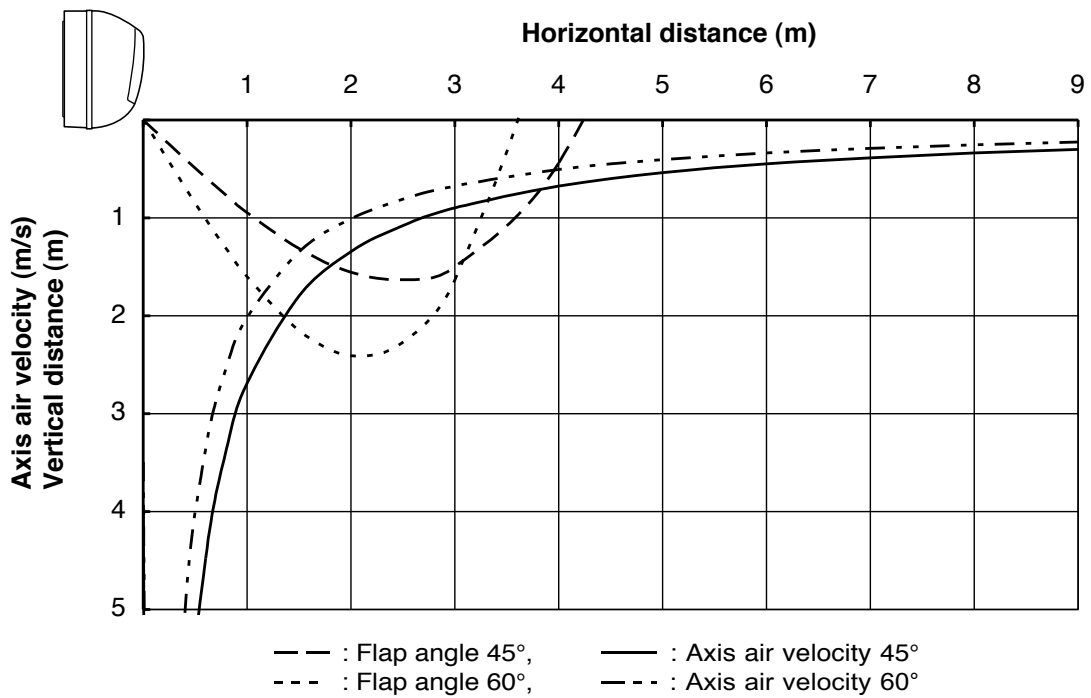

Cooling

Room air temp. : 27°C
 Fan speed : High

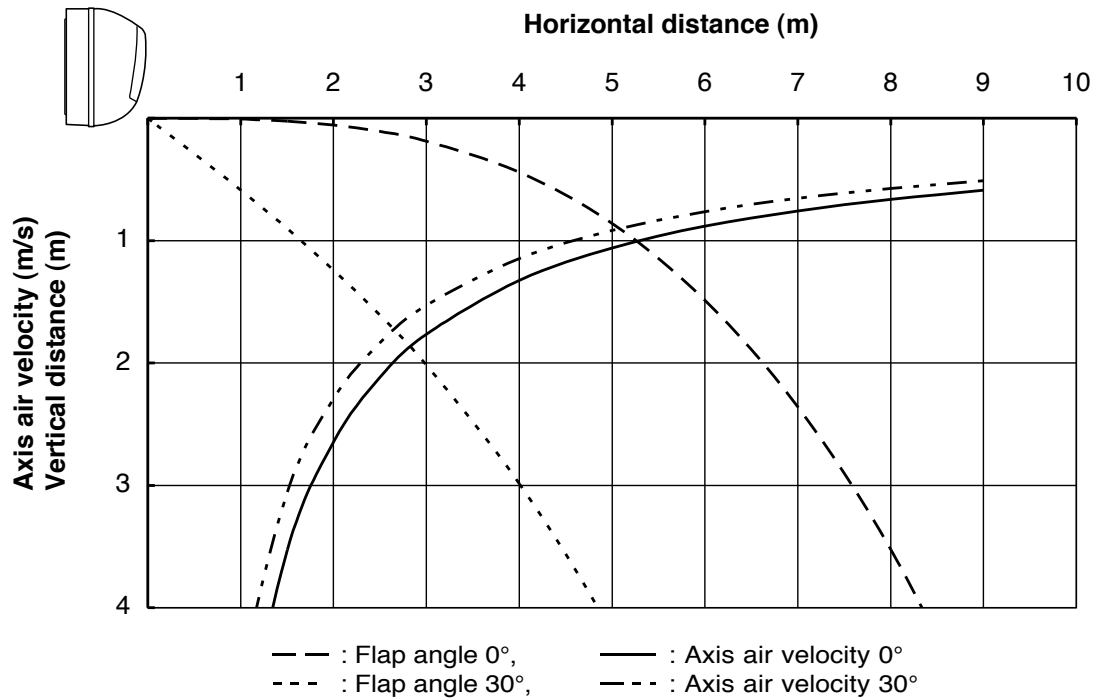

Heating

Room air temp. : 20°C
 Fan speed : High

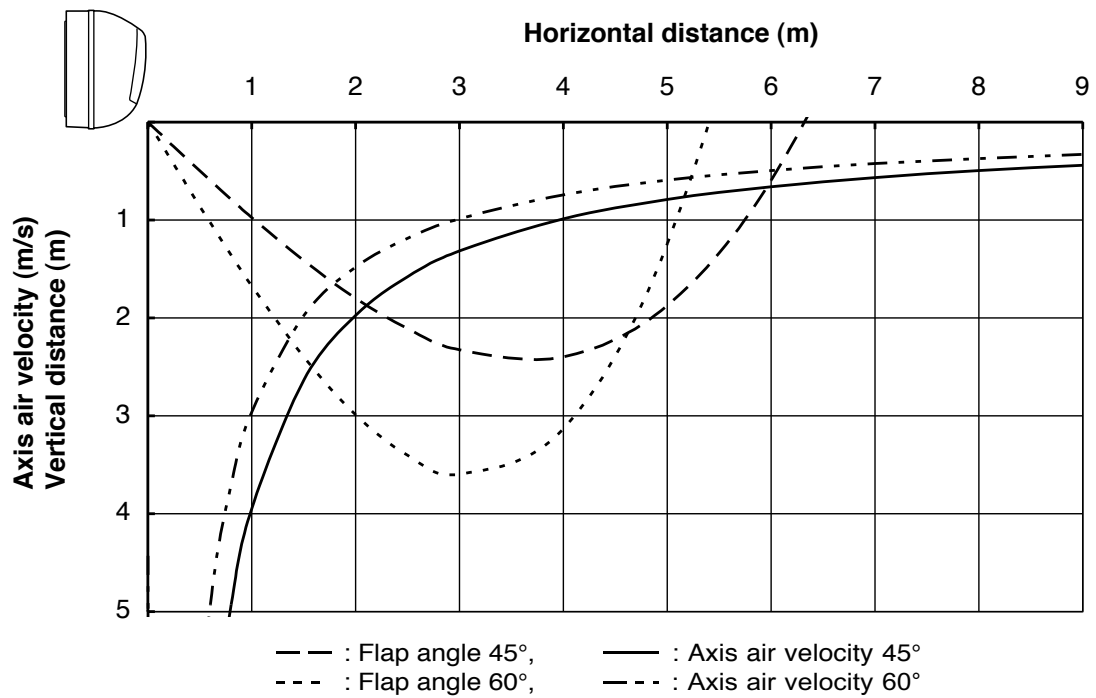

Cooling

Room air temp. : 27°C
 Fan speed : High

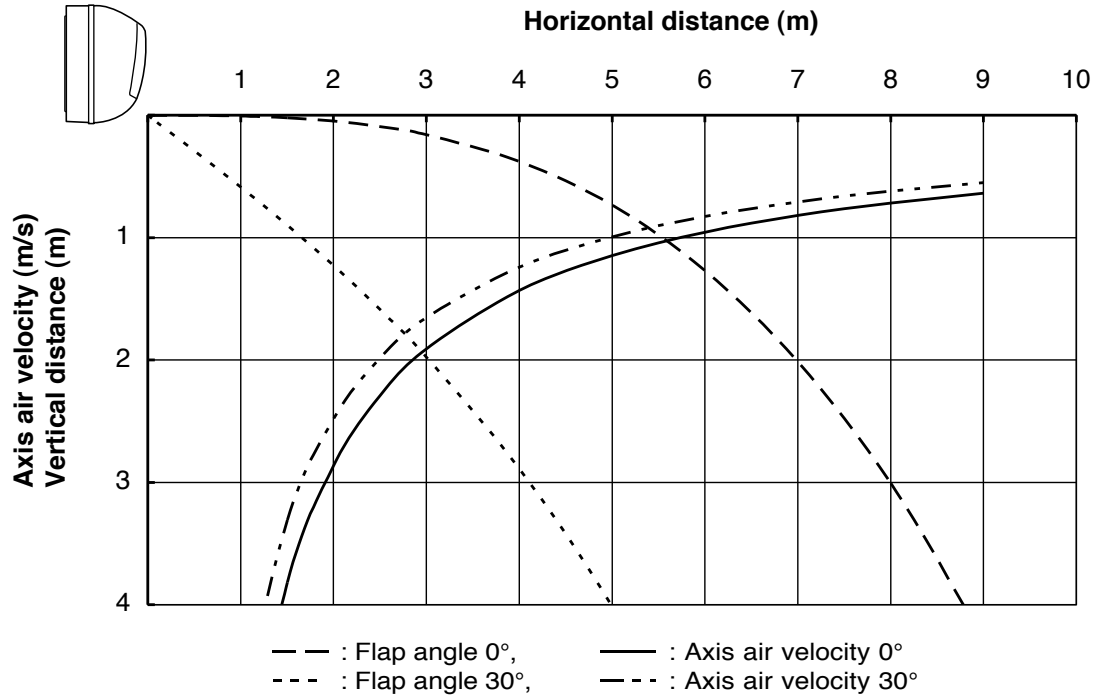

Heating

Room air temp. : 20°C
 Fan speed : High

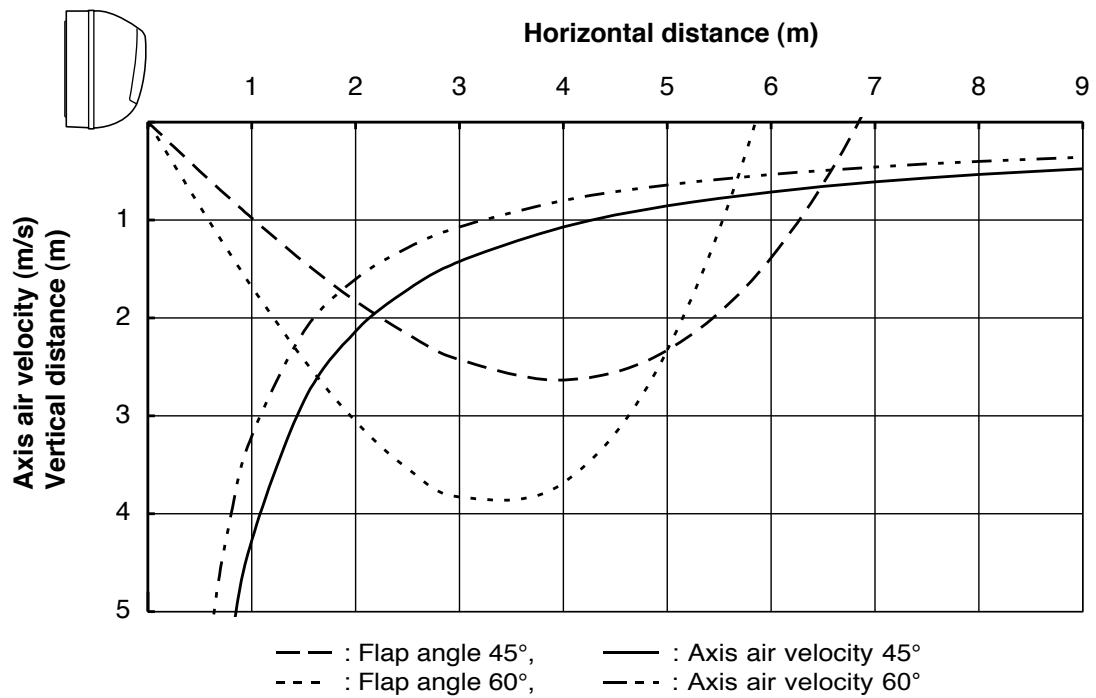

6. ELECTRICAL DATA

6-1. Electric Wiring Diagrams

Indoor Unit **MPAF90MR5I**
 MPAF120MR5I



WARNING

To avoid electrical shock hazard, be sure to disconnect power before checking, servicing and/or cleaning any electrical parts.

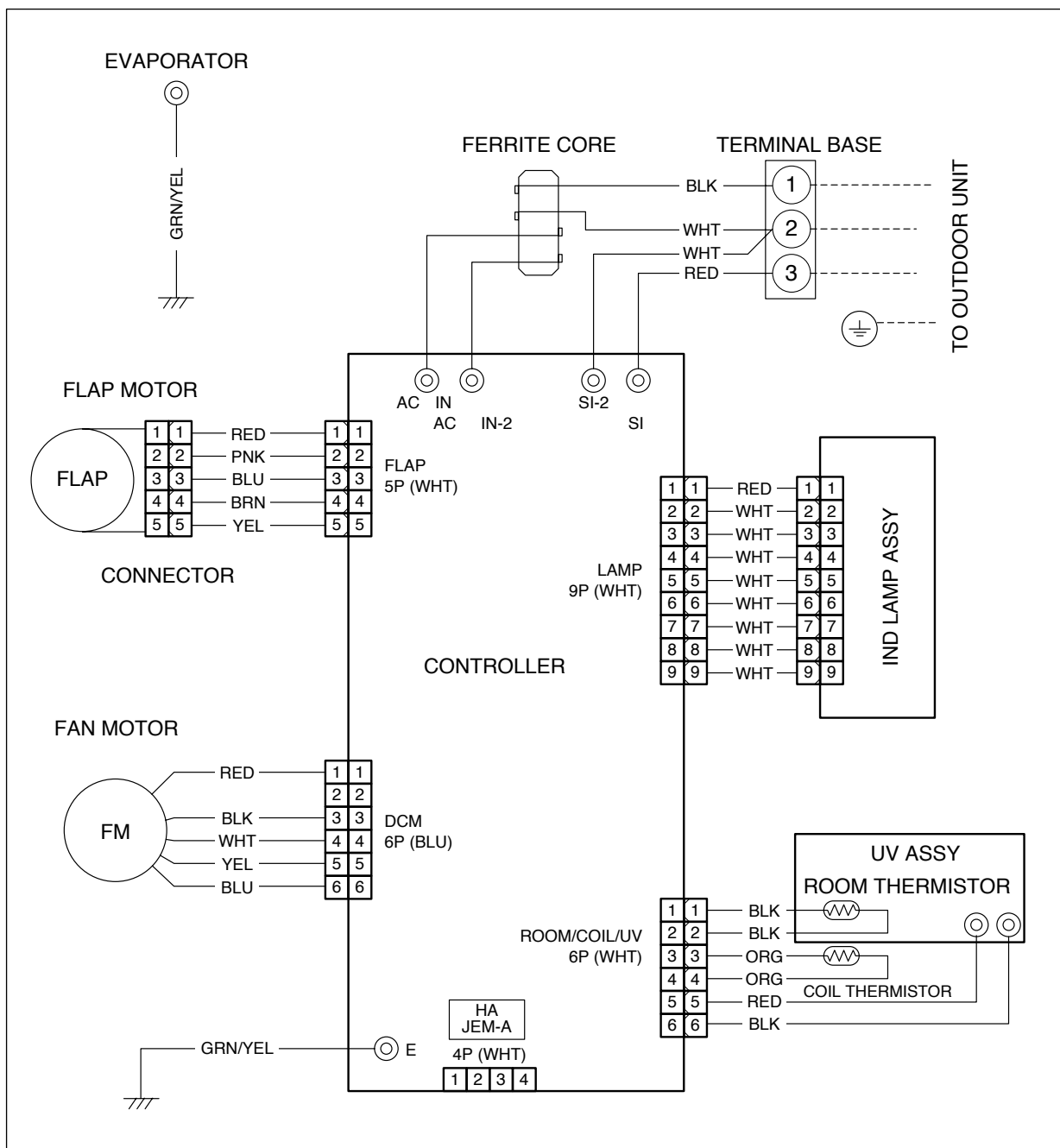

8FA-2-5250-29700-2

Indoor Unit **MPAF180R5I**
MPAF240R5I



WARNING

To avoid electrical shock hazard, be sure to disconnect power before checking, servicing and/or cleaning any electrical parts.

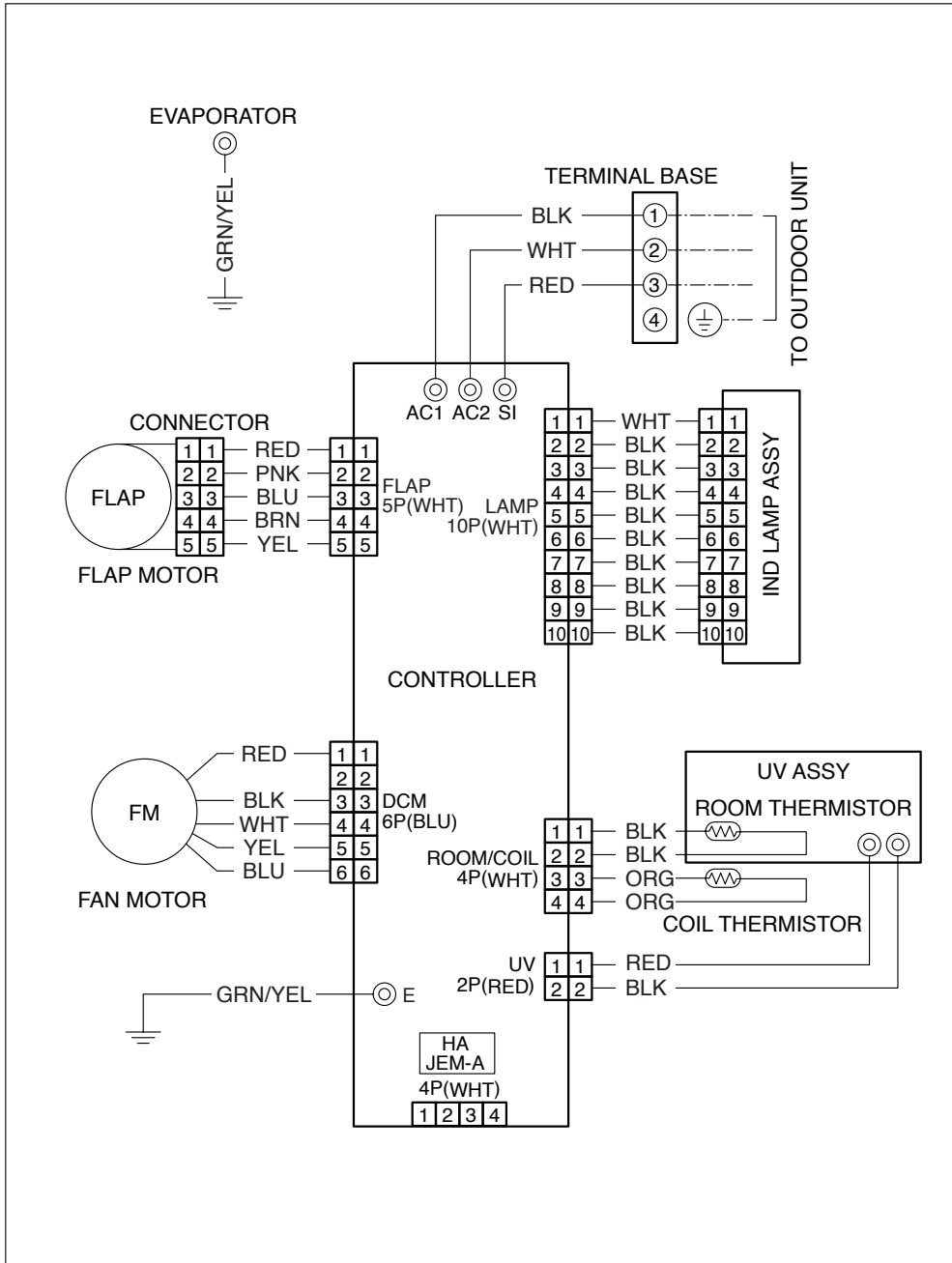

8FA2-5250-27700-1

7. FUNCTIONS

7-1. Operation Functions

Emergency operation

Emergency operation is available when the remote controller malfunctions, has been lost, or otherwise cannot be used.

To operate the system, press the OPERATION button, which is also used as the receiver, below the unit display. Each time this button is pressed, the OPERATION lamp changes color to indicate the type of operation. Select the desired type of operation.

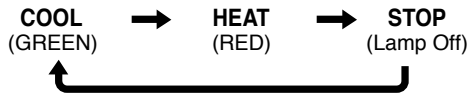

- The set temperature is 2 °C below the detected room temperature in the case of cooling operation, and 2 °C above the room temperature in the case of heating operation. The flap and fan speed settings are AUTO.

AUTO cooling/heating operation

Selecting the operation mode

- When AUTO mode is selected, the microprocessor calculates the difference between the set temperature and the room temperature, and automatically switches to Cooling or Heating mode.

Room temp. \geq Set temp. \rightarrow COOL

Room temp. $<$ Set temp. \rightarrow HEAT

- As shown by the example in the figure below, with AUTO cooling/heating operation, the mode changes between Heating and Cooling mode according to changes in the relationship between the current room temperature and the set temperature.

Example

Example of operation in AUTO mode with the set room temperature at 23 °C.

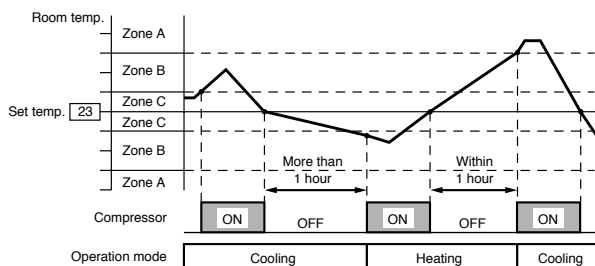

NOTE

When multiple indoor units are used and units in other rooms are already operating, they will be set to the same mode of operation as the operating indoor units.

SENSOR DRY

During DRY operation, the system adjusts the room temperature and fan speed according to the conditions in the room, in order to maintain a comfortable room environment.

SENSOR DRY operation

- DRY operation is as shown in the figure below.

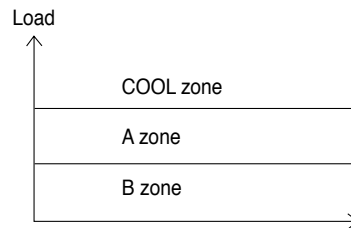

Conditions are monitored at all times when the room temperature is below 15 °C.

DRY A

The compressor operation frequency varies. The indoor fan operates with 1/f fluctuation.

DRY B

The compressor operates at a low operating frequency. The indoor fan operates with 1/f fluctuation.

Monitor

- Monitoring operation takes place when the room temperature is below 15 °C, or more than 3 °C below the set temperature.
- When the monitoring range is entered, the compressor stops, and the indoor fan operates with 1/f fluctuation.

PAM- α control

- In order to further improve inverter performance, control is switched between PWM control at low operation speeds, and PAM control at high operation speeds, making the most effective use of power.

■ HIGH POWER

This function acts to raise the power but keeps the AC system in the same operating mode.

This function is set with the HIGH POWER button on the remote controller.

(It can be set regardless of the temperature and fan speed settings.)

● HIGH POWER operation from remote controller

The unit operates at maximum output for 30 minutes, regardless of the desired temperature.

The fan speed is 1 step above "High."

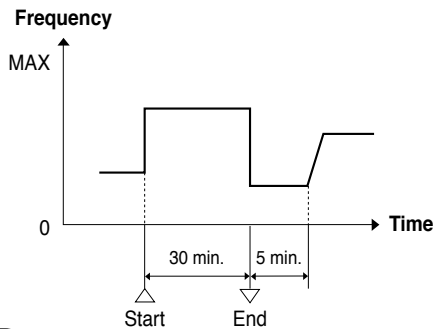

NOTE

- When HIGH POWER operation ends, the unit operates at low Hz for 5 minutes, regardless of the thermostat OFF conditions.
- When in DRY mode, operation is in the cooling zone.

■ Lamp colors

OPERATION lamp

HEAT operation	Red
DRY operation	Orange
COOL operation	Green
DEFROSTING operation	Red and Orange alternately

TIMER lamp

Green

LED CLEAN lamp

Green

■ Timer backup

- Operation stops if there are no operator controls for 25 hours or longer after unit operation switched from OFF to ON by use of ON timer operation.

■ NIGHT SETBACK

- When NIGHT SETBACK operation is set, the temperature and fan speed settings will be adjusted automatically to allow comfortable sleep.
- When NIGHT SETBACK operation is set, "☺ mark" appears on the remote controller. The main unit display lamp also becomes dimmer.

● COOL and DRY modes

When the night setback mode is selected, the air conditioner automatically raises the temperature setting 1°C when 30 minutes have passed after the selection was made, and then another 1°C after another 30 minutes have passed, regardless of the indoor temperature when night setback was selected. This enables you to save energy without sacrificing comfort. This function is convenient when gentle cooling is needed.

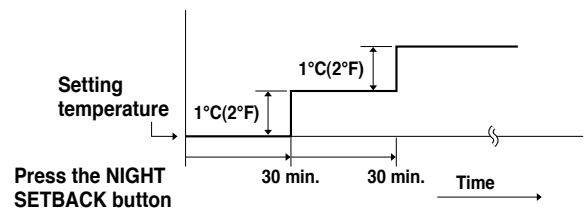

● HEAT mode

When the night setback mode is selected, the air conditioner automatically lowers the temperature setting 2°C when 30 minutes have passed after the selection was made, and then another 2°C after another 30 minutes have passed, regardless of the indoor temperature when night setback was selected. This enables you to save energy without sacrificing comfort. This function is convenient when gentle heating is needed.

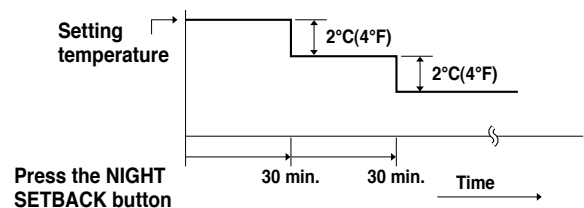

7-2. Protective Functions

Overload prevention during heating

During HEAT operation, the temperature of the indoor heat exchanger is used to control the frequency and lessen the load on the compressor before the protective device is activated.

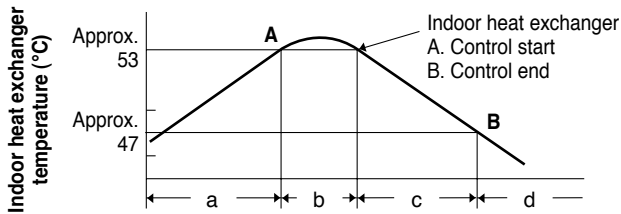

- Area: Automatic capacity control
- When Point A has been exceeded, the operation frequency is reduced by a certain proportion.
- Area: Frequency increase is prohibited.
- At Point B and below, overload prevention is ended and control is the same as in the a area.

Freeze prevention

During COOL or DRY operation, freezing is detected and operation is stopped when the temperature of the indoor heat exchanger matches the conditions below.

- Freeze-prevention operation is engaged when the temperature of the indoor heat exchanger is below 6 °C.
- Restart after freeze-prevention operation occurs when the temperature of the indoor heat exchanger reaches 8 °C or above.

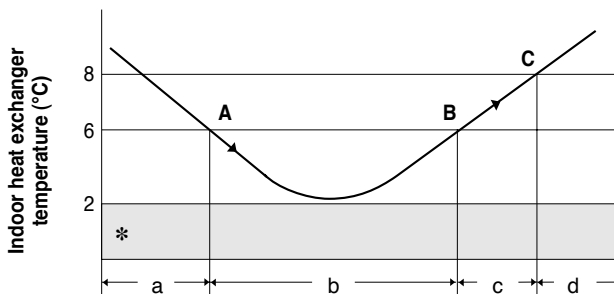

- Area: Automatic capacity control
- When the temperature drops below Point A, the operation frequency is reduced by a certain proportion.
- Area: Frequency increase is prohibited.
- When the temperature reaches Point C or above, freezing prevention is ended and control is the same as in the a area.

* When the temperature drops to below 2 °C (continuously for 2 minutes or longer), the compressor stops. Once the freeze condition is detected, the air conditioner will work less than the maximum frequency until it is turned off.

Cold-air prevention during heating

During heating, the fan speed is set to "LL" (very low) or stopped. As the temperature of the indoor heat exchanger rises, the fan speed is changed to the set speed.

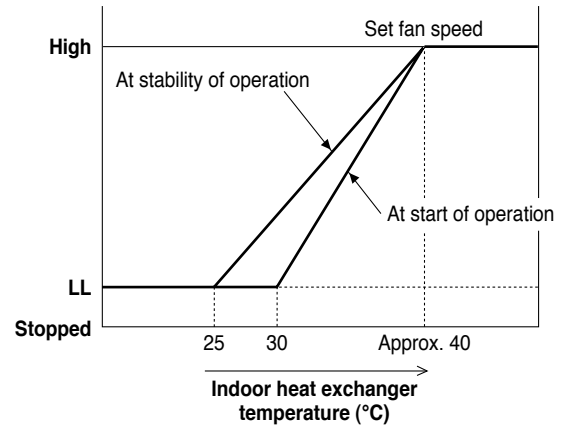

NOTE

- The fan speed is forcibly changed to "LL" beginning 30 seconds after the thermostat turns OFF.
- At stability of operation refers to operation when the room temperature has approached the set temperature.
- When HEAT operation starts, the indoor fan is stopped until the temperature of the indoor heat exchanger reaches 20 °C or higher, or until the room temperature reaches 15 °C or higher.

8. TROUBLESHOOTING

8-1. Precautions before Performing Inspection or Repair

- After checking the self-diagnostics monitor, turn the power OFF before starting inspection or repair.
- High-capacity electrolytic capacitors are used inside the outdoor unit controller (inverter). They retain an electrical charge (charging voltage DC 310V) even after the power is turned OFF, and some time is required for the charge to dissipate. Be careful not to touch any electrified parts before the controller LED (red) turns OFF.
If the outdoor controller is normal, approximately 30 seconds will be required for the charge to dissipate. However, allow at least 5 minutes for the charge to dissipate if there is thought to be any trouble with the outdoor controller.

8-2. Method of Self-Diagnostics

Follow the procedure below to perform detailed trouble diagnostics.

NOTE

- 1: If the operation lamp blinks every 0.5 seconds immediately when the power is turned ON, there is an external ROM (OTP data) failure on the indoor circuit board, or a ROM socket insertion problem, or the ROM has not been installed.
- 2: The failure mode is stored in memory even when the power is not ON. Follow the procedure below to perform diagnostics.

PROCEDURE

After turning on power to the air conditioner, use the remote controller and follow the steps below to execute self-diagnostics.

- Step 1: Press and hold the remote controller QUIET button and 1 HR TIMER button. Then, press and hold the ACL (reset) button with a pointed object such as the tip of a pen. After 5 seconds, release ACL button first, then release QUIET and 1 HR TIMER buttons, "oP-1" (test run) appears, blinking in the remote controller clock display area.
- Step 2: Next, press the 1 HR TIMER button once to change the display from "oP-1" to "oP-3" (self-diagnostics). (The display continues to blink.)
- Step 3: Finally press the ON/OFF button to engage self-diagnostics mode.

- The self-diagnostics function utilizes the 3 indicator lamps on the main unit, in combinations of ON lamps, blinking lamps, and OFF lamps, to report the existence of sensor trouble or a protective operation. (The lamps blink or remain ON for 5 seconds, then turn OFF for 2 seconds.) Self-diagnostics is completed when the buzzer sounds 3 short beeps.
- A maximum of 3 self-diagnostics reports are displayed, for 5 seconds each, beginning with the most recent report. Following this display the lamps turn OFF. In order to view the self-diagnostics results again, press the ON/OFF button again.
- The 3 lamps remain OFF if no trouble has occurred.

<IMPORTANT> After self-diagnostics is completed, be sure to press the ACL (reset) button to return to normal mode. The air conditioner will not operate if this is not done.

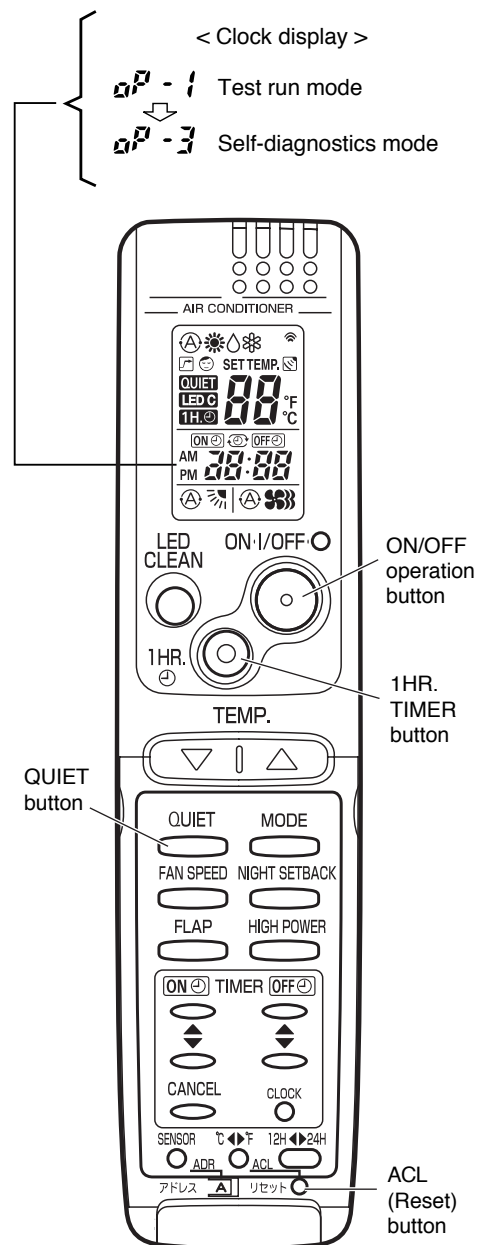

(1) Self-diagnostics Lamps

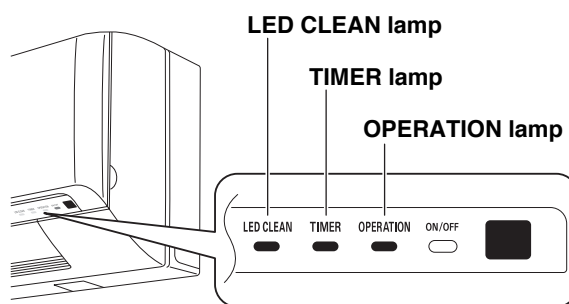

• Since the indications cover various units, the corresponding parts listed below may not be present in some models.

Indication on indoor unit				✕ ... OFF	◐ ... Blinking	☀ ... ON (Illuminated)	
Quiet (3)	Timer (2)	Operation (1)	Code	Diagnostics items	Diagnostics contents		
✕	✕	◐	S01	Room temperature sensor failure	(1) Sensor open circuit or short circuit		
✕	◐	✕	S02	Indoor heat exchanger sensor failure	(2) Contact failure at connector or open circuit at terminal crimping location (short-circuit detection only for the humidity sensor)		
✕	◐	◐	S03	Humidity sensor failure	(3) Indoor/outdoor PCboard failure		
◐	✕	✕	S04	Compressor temperature sensor failure	(1) Sensor open circuit or short circuit		
◐	✕	◐	S05	Outdoor heat exchanger sensor failure	(2) Contact failure at connector or open circuit at terminal crimping location		
◐	◐	✕	S06	Outdoor air temperature sensor failure	(3) Outdoor PCboard failure		
◐	◐	◐	S07	Outdoor electrical current detection failure	Outdoor PCboard failure		
✕	✕	☀	E01	Indoor/outdoor communications failure (serial communications)	(1) Mis-wiring (2) AC power failure (3) Blown fuse (4) Power Relay failure (5) Indoor or outdoor PCboard failure (6) Outdoor Fan Motor failure (7) Reactor failure (8) High-Pressure Switch failure (9) Overload Relay failure (10) Magnetic Coil failure * See detailed flowchart in this section.		
✕	☀	✕	E02	• HIC circuit failure • Power Tr (transistor) circuit failure	(1) HIC or power Tr failure (2) Outdoor fan does not turn. (3) Instantaneous power outage (4) Service valve not opened. (5) Outdoor fan blocked. (6) Continuous overload operation (7) Compressor failure (8) Outdoor PCboard failure		
✕	☀	☀	E03	Outdoor unit external ROM (OTP data) failure	(1) External ROM data failure (2) Outdoor PCboard failure		
☀	✕	✕	E04	Peak current cut-off	(1) Instantaneous power outage (2) HIC or power transistor failure (3) Outdoor PCboard failure		
☀	✕	☀	E05	• PAM circuit failure • Active circuit failure	(1) Outdoor PCboard failure (2) Outdoor power supply voltage failure		
☀	☀	✕	E06	Compressor discharge overheat prevention activated.	(1) Electric expansion valve failure (2) Capillaries choked (3) Shortage of refrigerant (4) Continuous overload operation (5) Outdoor fan does not rotate (6) Outdoor PCboard failure		
☀	☀	☀	E07	Indoor fan operating failure	(1) Fan motor failure (2) Contact failure at connector (3) Indoor PCboard failure		
◐	◐	☀	E08	• 4-way valve switching failure • Indoor zero-cross failure	(1) 4-way valve failure (heat pump model only) (2) Outdoor PCboard failure		
◐	☀	◐	E09	No-refrigerant protection	(1) Service valve not opened. (2) Shortage of refrigerant		
◐	☀	☀	E10	DC compressor drive circuit failure	(1) Open phase (2) Outdoor PCboard failure		
☀	◐	◐	E11	Outdoor fan operating failure	(1) Fan motor failure (2) Contact failure at connector (3) Outdoor PCboard failure		
☀	◐	☀	E12	• Outdoor system communications failure • OLR operation • Outdoor power supply open phase • Outdoor coil freezing	(1) Mis-wiring (2) Blown fuse (3) Power Relay failure (4) Outdoor PCboard failure (5) Compressor failure * See detailed flowchart in this section.		
☀	☀	◐	E13	Freeze-prevention operation activated.	(1) Indoor fan system failure (2) Shortage of refrigerant (3) Low-temperature operation		

8-4. Trouble Diagnosis of Fan Motor

8-4-1. Indoor Fan Motor

- This indoor DC fan motor contains an internal control PCB. Therefore, it is not possible to measure the coil resistance, and the following procedure should be used to check the motor.
- To perform diagnosis, operate the unit in cooling mode with indoor fan speed "High". Next, make sure that the indoor unit receive the signals from the remote controller when the ON/OFF operation button is pressed.

Important: (A) Turn OFF the power before connecting or disconnecting the motor connectors.
(B) When performing voltage measurement at the indoor controller connector for (3) in the table below, the DC motor will trip and voltage output will stop approximately 1 minute after operation is started. For this reason, to measure the voltage again, turn OFF the unit once using the remote controller, and then start the air conditioner again.

[Trouble symptom 1] The fan does not stop when the unit stops. → Indoor unit controller trouble.

[Trouble symptom 2] The fan motor does not rotate when the unit is operating.

(Diagnostic procedure)

* Disconnect the motor connectors and measure the voltage at the DC motor connectors on the indoor unit controller (3 locations).

Measurement location	Normal value
(1) Vm-Gnd: Between pin 1 and pin 3	DC 230V or more
(2) Vcc-Gnd: Between pin 4 and pin 3	DC 14V or more
(3) Vs-Gnd: Between pin 5 and pin 3	Fluctuation between DC 1.7 to 6.1V

(Diagnostic results)

All of the above measured values are normal. → Fan motor trouble (Replace the motor.)

Any one of the above measured values is not normal. → Indoor unit controller trouble
(Replace the controller .)

(Reference) DC motor connector pin arrangement

- Pin 1: Vm (red)
- Pin 2: Not used
- Pin 3: Gnd (black)
- Pin 4: Vcc (white)
- Pin 5: Vs (yellow)
- Pin 6: PG (blue)

[Trouble symptom 3] Motor rotates for some time (several seconds), but then quickly stops, when the indoor unit operates.

(There is trouble in the system that provides feedback of motor rotation speed from the motor to the indoor unit controller.)

[Trouble symptom 4] Fan motor rotation speed does not change during indoor unit operation.

[Trouble symptom 5] Fan motor rotation speed varies excessively during indoor unit operation.

(Remedy for symptom 3 to 5)

It is not possible to identify whether the trouble is indoor unit controller trouble or motor trouble.

Therefore, first replace the indoor unit controller, then (if necessary) replace the DC motor.

8-5. Noise Malfunction and Electromagnetic Interference

An inverter A/C operates using pulse signal control and high frequencies. Therefore, it is susceptible to the effects of external noise, and is likely to cause electromagnetic interference with nearby wireless devices.

A noise filter is installed for ordinary use, preventing these problems. However, depending on the installation conditions, these effects may still occur. Please pay attention to the points listed below.

(1) Noise malfunction

This refers to the application of high-frequency noise to the signal wires, resulting in abnormal signal pulses and malfunction.

Locations most susceptible to noise	Trouble	Correction
<ol style="list-style-type: none"> Locations near broadcast stations where there are strong electromagnetic waves Locations near amateur radio (short wave) stations Locations near electronic sewing machines and arc-welding machines 	Either of the following trouble may occur. <ol style="list-style-type: none"> The unit may stop suddenly during operation. Indicator lamps may flicker. 	(The fundamental concept is to make the system less susceptible to noise.) <ul style="list-style-type: none"> - Insulate for noise or distance from the noise source. - <ol style="list-style-type: none"> Use shielded wires. Move unit away from the noise source.

(2) Electromagnetic interference

This refers to noise generated by high-speed switching of the microcomputer and compressor. This noise radiates through space and returns to the electric wiring, affecting any wireless devices (televisions, radios, etc.) located nearby.

Locations most susceptible to noise	Trouble	Correction
<ol style="list-style-type: none"> A television or radio is located near the A/C and A/C wiring. The antenna cable for a television or radio is located close to the A/C and A/C wiring. Locations where television and radio signals are weak. 	<ol style="list-style-type: none"> Noise appears in the television picture, or the picture is distorted. Static occurs in the radio sound. 	<ol style="list-style-type: none"> Select a separate power source. Keep the A/C and A/C wiring at least 1 meter away from wireless devices and antenna cables. Change the wireless device's antenna to a high-sensitivity antenna. Change the antenna cable to a BS coaxial cable. Use a noise filter (for the wireless device). Use a signal booster.



0.8180.590.00 04/2010
R.D. 28 Reyrieux BP 131 - 01601 Trévoux CEDEX France
Tél. 04.74.00.92.92 - Fax 04.74.00.42.00
R.C.S. Bourg-en-Bresse B 759 200 728