

---

## **SPLIT SYSTEM AIR CONDITIONER**

Model No.	Product Code No.
CAFP255R5I	38.7130.063
CAFP365R5I	38.7130.064
CAFP485R5I	38.7130.065

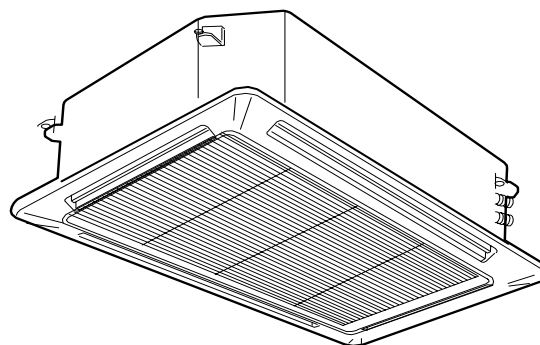
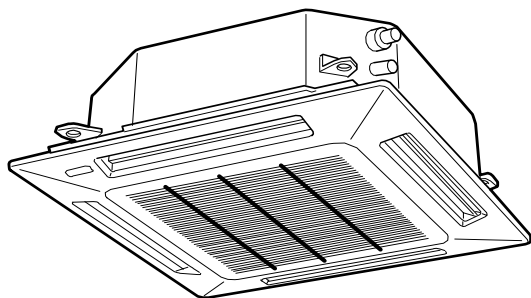

## IMPORTANT! Please read before installation

This air conditioning system meets strict safety and operating standards.

For the installer or service person, it is important to install or service the system so that it operates safely and efficiently.

### For safe installation and trouble-free operation, you must:

- Carefully read this instruction booklet before beginning.
- Follow each installation or repair step exactly as shown.
- Observe all local, state and national electrical codes.
- Pay close attention to all warning and caution notices given in this manual.
- The unit must be supplied with a dedicated electrical line.



### WARNING

This symbol refers to a hazard or unsafe practice which can result in severe personal injury or death.



### CAUTION

This symbol refers to a hazard or unsafe practice which can result in personal injury or product or property damage.

### If necessary, get help

These instructions are all you need for most installation sites and maintenance conditions.

If you require help for a special problem, contact our sale/service outlet or your certified dealer for additional instructions.

### In case of improper installation

The manufacturer shall in no way be responsible for improper installation or maintenance service, including failure to follow the instructions in this document.

## SPECIAL PRECAUTIONS

- During installation, connect before the refrigerant system and then the wiring one; proceed in the reverse order when removing the units.

### WARNING

#### When wiring



**ELECTRICAL SHOCK CAN CAUSE SEVERE PERSONAL INJURY OR DEATH. ONLY QUALIFIED, EXPERIENCED ELECTRICIANS SHOULD ATTEMPT TO WIRE THIS SYSTEM.**

- Do not supply power to the unit until all wiring and tubing are completed or reconnected and checked, to ensure the grounding.
- Highly dangerous electrical voltages are used in this system. Carefully refer to the wiring diagram and these instructions when wiring. Improper connections and inadequate grounding can cause **accidental injury and death.**

- **Ground the unit** following local electrical codes.
- The Yellow/Green wire cannot be used for any connection different from the ground connection.
- Connect all wiring tightly. Loose wiring may cause overheating at connection points and a possible fire hazard.
- Do not allow wiring to touch the refrigerant tubing, compressor, or any moving parts of the fan.
- Do not use multi-core cable when wiring the power supply and control lines. Use separate cables for each type of line.

### When transporting

Be careful when picking up and moving the indoor and outdoor units. Get a partner to help, and bend your knees when lifting to reduce strain on your back. Sharp edges or thin aluminium fins on the air conditioner can cut your fingers.

### When installing...

#### ... In a ceiling

Make sure the ceiling is strong enough to hold the unit-weight. It may be necessary to build a strong wooden or metal frame to provide added support.

#### ... In a room

Properly insulate any tubing run inside a room to prevent "sweating", which can cause dripping and water damage to walls and floors.

#### ... In moist or uneven locations

Use a raised concrete base to provide a solid level foundation for the outdoor unit. This prevents damage and abnormal vibrations.

#### ... In area with strong winds

Securely anchor the outdoor unit down with bolts and a metal frame. Provide a suitable air baffle.

#### ... In a snowy area (for heat pump-type systems)

Install the outdoor unit on a raised platform that is higher than drifting snow. Provide snow vents.

### When connecting refrigerant tubing

- Keep all tubing runs as short as possible.
- Use the flare method for connecting tubing.
- Apply refrigerant lubricant to the matching surfaces of the flare and union tubes before connecting them; screw by hand and then tighten the nut with a torque wrench for a leak-free connection.
- Check carefully for leaks before starting the test run.

### NOTE:

Depending on the system type, liquid and gas lines may be either narrow or wide. Therefore, to avoid confusion, the refrigerant tubing for your particular model is specified as narrow tube for liquid, wide tube for gas.

### When servicing

- Turn the power OFF at the main power board before opening the unit to check or repair electrical parts and wiring.
- Keep your fingers and clothing away from any moving parts.
- Clean up the site after the work, remembering to check that no metal scraps or bits of wiring have been left inside the unit being serviced.
- Ventilate the room during the installation or testing the refrigeration system; make sure that, after the installation, no gas leaks are present, because this could produce toxic gas and dangerous if in contact with flames or heat-sources.

# Table of Contents

	Page
<b>1. SPECIFICATIONS</b>	<b>4</b>
1-1 Unit specifications	4
1-2 Major Component specifications	6
1-3 Other Component specifications	8
<b>2. DIMENSIONAL DATA</b>	<b>9</b>
<b>3. ELECTRICAL DATA</b>	<b>11</b>
3-1 Electric Wiring Diagram	11
3-2 Control PCB switches and functions	12
<b>4. PROCESS AND FUNCTIONS</b>	<b>13</b>
4-1 Control function	13
<b>5. REPLACING PCB</b>	<b>16</b>
5-1 Replacing PCB	16
5-2 How to replace PCB	17
5-3 How to replace EEPROM with EEPROM included in PCB service pack	18
5-4 Table of setting	20
<b>6. SERVICE PROCEDURE</b>	<b>21</b>
6-1 Meaning of alarm message	21
6-2 Led indicator messages on outdoor control PCB	22
6-3 Symptoms and parts to inspect	23
6-4 Details of alarm messages	24
6-5 Table of thermistor characteristics	27
<b>7. OUTDOOR UNIT MAINTENANCE REMOTE CONTROL</b>	<b>28</b>
7-1 Overview	28
7-2 Functions	28
7-3 Normal display operations and functions	29
7-4 Monitoring operations:	
Display of indoor unit and outdoor unit sensor temperatures	32
7-5 Monitoring the outdoor unit alarm history:	
Display of outdoor unit alarm history	33
7-6 Setting modes: setting of outdoor unit EEPROM	33

# 1. SPECIFICATIONS

## 1-1 Unit Specifications

### CAFP255R5I

<b>Power source</b>	220 - 240V ~ 50Hz
---------------------	-------------------

<b>Voltage rating</b>	230V
-----------------------	------

<b>Performance</b>	<b>Cooling</b>	<b>Heating</b>
Capacity	See catalogue with the requested matching	
Air circulation (High/Med./Low)	m³/h 1140/1020/840	

<b>Features</b>			
Controls/Temperature controls		Microprocessor/ I.C. thermostat	
Remote Controller (Option)		wired	K70D036Z / K70D042Z
		wireless	K70D038Z / K70D040Z
Fan speed		3 and Auto	
Airflow direction		Auto (Remote control)	
Air Filter		Washable	
Sound pressure level	high/med/low	dB(A)	56/54/50
Refrigerant tubing connections		Flare type	
Refrigerant tube diameter	Narrow tube	mm(in.)	9,52 (3/8)
	Wide tube	mm(in.)	15,88 (5/8)
Refrigerant		R410A	
Refrigerant control		Electronic expansion valve	

<b>Dimensions &amp; Weight</b>				
Dimensions (include panel)	Unit	Height	mm	338
		Width	mm	860
		Depth	mm	860
Package dimensions	Unit	Height	mm	320
		Width	mm	880
		Depth	mm	840
		Volume	m3	0,238
Ceiling panel	Ceiling panel	Height	mm	110
		Width	mm	965
		Depth	mm	965
		Volume	m3	0,1
Weight (include panel)		Net	kg	22
		Shipping	kg	26
Ceiling panel	Ceiling panel	Net	kg	6
		Shipping	kg	8

DATA SUBJECT TO CHANGE WITHOUT NOTICE

## CAFP365/485R5I

<b>Power source</b>	220 - 240V ~ 50Hz
---------------------	-------------------

<b>Voltage rating</b>	230V
-----------------------	------

<b>Performance</b>	Cooling	Heating
Capacity	See catalogue with the requested matching	
Air circulation (High/Med./Low)	m <sup>3</sup> /h 1920/1680/1320	

<b>Features</b>		
Controls/Temperature controls		Microprocessor/ I.C. thermostat
Remote Controller (Option)	wired	K70D036Z / K70D042Z
	wireless	K70D038Z / K70D040Z
Fan speed		3 and Auto
Airflow direction		Auto (Remote control)
Air Filter		Washable
Sound pressure level	high/med/low	dB(A) 62/59/55
Refrigerant tubing connections		Flare type
Refrigerant tube diameter	Narrow tube	mm(in.) 9,52 (3/8)
	Wide tube	mm(in.) 15,88 (5/8)
Refrigerant		R410A
Refrigerant control		Electronic expansion valve

<b>Dimensions &amp; Weight</b>				
Dimensions (include panel)	Unit	Height	mm	368
		Width	mm	1150
		Depth	mm	860
Package dimensions	Unit	Height	mm	350
		Width	mm	1170
		Depth	mm	840
		Volume	m <sup>3</sup>	0,35
Ceiling panel	Unit	Height	mm	110
		Width	mm	1250
		Depth	mm	965
		Volume	m <sup>3</sup>	0,131
Weight (include panel)	Unit	Net	kg	27
		Shipping	kg	32
Ceiling panel	Unit	Net	kg	8
		Shipping	kg	10

DATA SUBJECT TO CHANGE WITHOUT NOTICE

## 1-2 Major Component Specifications

### CAFP255R5I

Controller PCB	
Part No.	CR-CRP50A-B
Controls	Microprocessor

Fan & Fan Motor	
Type	Centrifugal fan
Q'ty ..... Dia. and length	1.... Ø 443
Fan motor model...Q'ty	SFG6X-41D6P...1
No. Of poles...rpm (230 V, High)	6 ... 470
Running Amps	A 0,611
Power input	W 31,4
Coil resistance (Ambient temp. 20 °C )	Ω BRN-WHT: 170,3 WHT-VLT: 18,1 VLT-ORG: 43,2 ORG-YEL: 43,2 WHT-PNK: 83,5 YEL-BLK: 60,2
Safety devices	Type Internal thermal protector
Operating temp. Open	°C 130 ± 8
Close	°C 79 ± 15
Run capacitor	μF 4,5
	VAC 440

Panel	
Model	K70N092T
Flap motor	M2LB24ZA12
rating	240 VAC
rpm	2,5
nominal output	W 3
coil resistance (25°C)	kΩ 15,62 ± 15%
Dew proof heater	240 V, 26W

Heat Exch. Coil	
Coil	Aluminium plate fin / Copper tube
Rows	2
Fin pitch	mm 1,5
face area	m2 0,343

DATA SUBJECT TO CHANGE WITHOUT NOTICE

## CAFP365/485R5I

Controller PCB	
Part No.	CR-CRP50A-B
Controls	Microprocessor

Fan & Fan Motor	
Type	Centrifugal fan
Q'ty ..... Dia. and lenght mm	1.... Ø 443
Fan motor model...Q'ty	SFG6X-81A6P...1
No. Of poles...rpm (230 V, High/Med/Low/LowLow)	6 ... 530
Running Amps A	0,765
Power input W	38
Coil resistance (Ambient temp. 20 °C ) Ω	BRN-WHT: 75,1 WHT-VLT: 6,7 VLT-ORG: 20,6 ORG-YEL: 27,4 WHT-PNK: 42,7 YEL-BLK: 58
Safety devices	Internal thermal protector
Type	
Operating temp. Open °C	130 ± 8
Close °C	79 ± 15
Run capacitor μF	5
VAC	440

Panel	
Model	K70N093T
Flap motor	M2LB24ZA12
rating	240 VAC
rpm	2,5
nominal output W	3
coil resistance (25°C) kΩ	15,62 ± 15%
Dew proof heater	240 V, 26W

Heat Exch. Coil	
Coil	Aluminium plate fin / Copper tube
Rows	2
Fin pitch mm	1,5
face area m2	0,556

DATA SUBJECT TO CHANGE WITHOUT NOTICE

## 1-3 Other Component Specifications

<b>Trasformer</b>		<b>ATR-IIJ225A</b>
Rating	Primary	VAC 230V, 50Hz
	Secondary 1	AC 20V - 0.2A
	Secondary 2	AC 14V - 0.3A
	Secondary 3	AC 10,2V - 1.4A
Thermal cut-off temp.		136°C

<b>Thermistor ( Coil sensor E1, E2)</b>		<b>PBC-41E-S26</b>
Resistance	kΩ	0 °C 15,0 ± 5%



<b>Thermistor ( Room sensor TA)</b>		<b>DHKTEC-35-S85N</b>
Resistance	kΩ	25 °C 5,0 ± 4%

<b>Drain pump</b>		
Model		WP20SL-21
Rating	Voltage	230V
	Input	12W
Total head / capacity		500 mm / 400 cc/min.

<b>Safety float switch</b>		
Model		FS-0218-102 (ASR425HG)
		FS-0218-103 (ASR436/448HG)
Contact rating		DC 12V - 25W

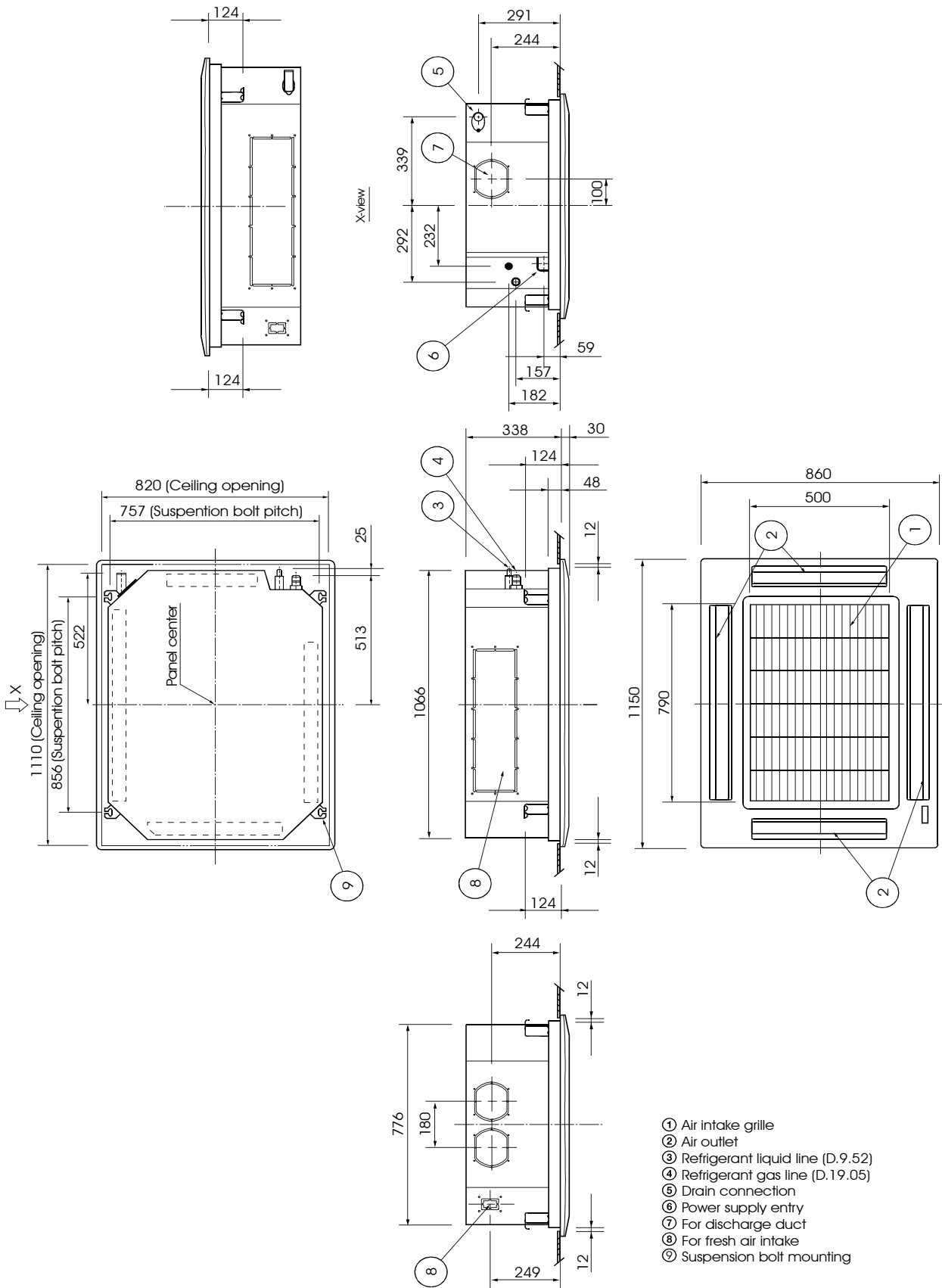

# CAFP365/485R5I



# 3. ELECTRICAL DATA

## 3-1 Electric Wiring Diagram

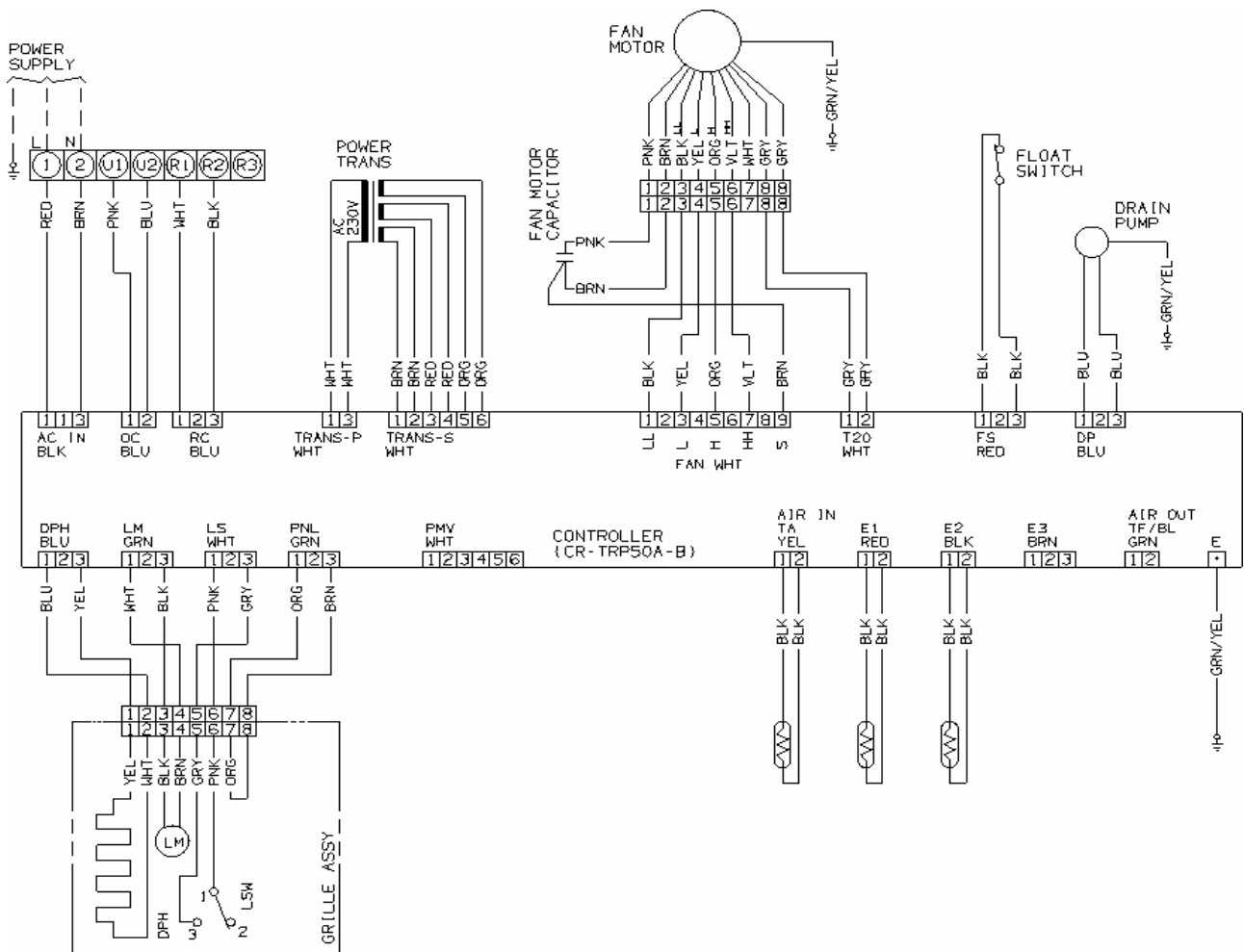

7P terminal board

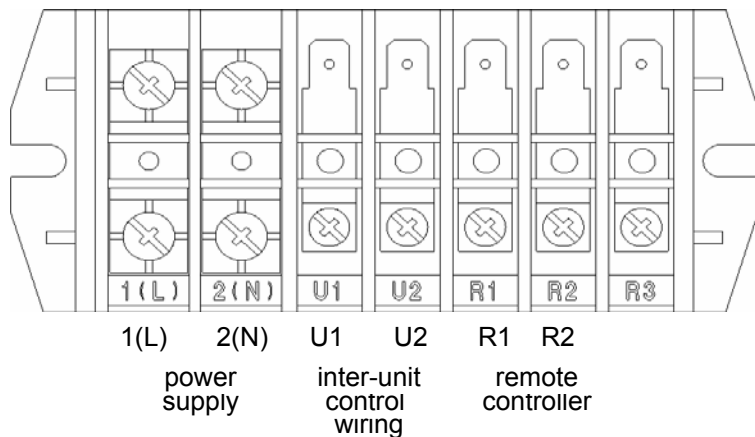

## 3-2 Control PCB switches and functions

### CR-TRP50A-B

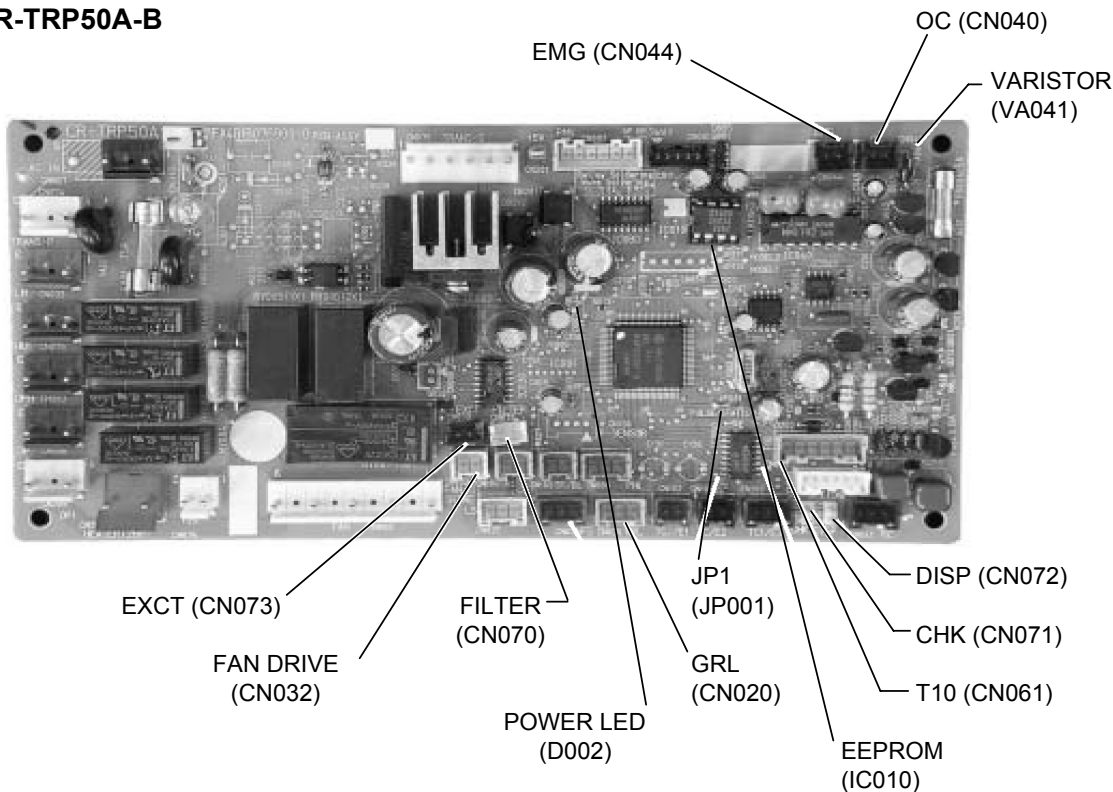

**T10:**  
(CN061)      **6 plug (yellow):** used for remote control. (Refer to the remote control section)

1- start/stop input	2- COM
3- remote control prohibit/release input	4- start signal output
5- COM (+DC12v)	6- alarm signal output T10

**EXCT:**  
(CN073)      **2P plug (red):** Can be used for demand control. When input is present, forces the unit to operate with the thermostat OFF.

**DISP:**  
(CN072)      **2P plug (white):** Short-circuiting this plug allows the unit to be operated by the remote controller, even if it is not connected to an outdoor unit. (In this case, alarm "E04", which indicates trouble in the serial communication between the indoor and outdoor unit, does not occur.)

**CHK:**  
(CN071)      **2P plug (white): Test pin.** Short-circuiting this pin allows the indoor FM (H fan speed), drain pump, flap motor (F1 position), and electronic expansion valve full-open position to be checked. However this function turns OFF if the indoor unit protection mechanism is activated. The unit can be operated even if the remote controller and outdoor unit are not connected. However even if the remote controller cannot be connected, it cannot be used to operate the unit. This function can be used for short-term tests.

**JP1:**  
(JP001)      Jumper wire: Allows selection of the T10 terminal

# 4. PROCESS AND FUNCTIONS

## 4-1 control functions

### Electronic control valve control

Opening of the electronic control valve is controlled so that the appropriate operating conditions are maintained, based on the signal from each sensor (discharge temperature [TD], intake temperature [TS], outdoor heat exchanger temperature [C1], and indoor heat exchanger temperature [E1, E2]).

### Discharge temperature release control

- (1) This control lowers the operating frequency of the compressor when electronic control valve control is unable to maintain the appropriate operating conditions because the discharge temperature fails to decline or because there is a sudden increase in the discharge temperature.
- (2) If the discharge temperature exceeds 111°C, the compressor is stopped and then restarted. (Error count = 1)
- (3) The error count is cleared when operation has continued for 10 minutes after the compressor was restarted.
- (4) If (2) repeats 4 times without the error count being cleared (error count = 4), alarm "P03" occurs.

### Current release control

The compressor operating frequency is controlled so that the current that is input to the inverter compressor does not exceed the designated value (control value).

### Outdoor unit fan control

#### 1. Cooling fan control

- (1) The outdoor unit fan minimum speed and maximum speed are determined according to the outdoor air temperature and the operating frequency. The speed is controlled in stages between the minimum speed and maximum speed, based on the outdoor heat exchanger temperature (C2) at that time.
- (2) For 60 seconds after start, the outdoor unit fan operates at maximum speed, as determined by the outdoor air temperature and operating frequency at that time. Subsequently, the fan operates at low speed until the outdoor heat exchanger temperature (C2) rises.
- (3) If the discharge temperature (TD) sensor is abnormal or has become disconnected, the fan will not operate and a protective device is activated.

#### 2. Heating fan control

- (1) The outdoor unit fan minimum speed and maximum speed are determined according to the outdoor air temperature and operating frequency. The speed is controlled in stages between the minimum speed and maximum speed, based on the outdoor heat exchanger temperature (C1) at that time.

- (2) If the outdoor heat exchanger temperature (C2) is 24°C or higher continuously for 5 minutes, fan operation may stop (same conditions as when the thermostat is OFF). In this case, the fan will restart after 3 minutes.
- (3) This control is not performed during the 3 minutes after start, for 1 minute after defrost ends, and while defrost is in progress.

### Coil heating control

- (1) This control applies current to the coil of the stopped compressor to heat the compressor in place of the crank case heater.
- (2) When the discharge temperature (TD) is less than 25°C, the current application judgment is made based on the outdoor air temperature (TO).
  - Current application starts when the outdoor air temperature drops to 15°C or below.
  - Current application stops when the outdoor air temperature rises above 18°C.

### Control for prevention of short intermittent operation

In order to protect the compressor, this control does not allow the compressor to be stopped for 10 minutes after operation starts, even if the thermostat OFF signal is received from the indoor unit.

### Control for prevention of high cooling loads

- (1) This control reduces abnormal high-pressure increases during cooling operation.
- (2) If the outdoor heat exchanger temperature (C2) reaches 64°C or above, the compressor is stopped. (Error count = 1)
- (3) 3 minutes after the compressor stops, if the outdoor heat exchanger temperature (C2) is less than 55°C the compressor is restarted. If operation subsequently continues for 10 minutes, the error count is cleared.
- (4) If the outdoor heat exchanger temperature (C2) again reaches 64°C or higher within 10 minutes after the compressor restarts, the compressor is stopped again. (Error count = 2)
- (5) If the above start/stop of the compressor is repeated 10 times (error count = 10), alarm "P20" occurs. At this time, operation stops and does not restart.
- (6) If the compressor has stopped because the outdoor heat exchanger temperature (C2) reached 64°C or higher, and the temperature remains at 64°C or higher for 30 seconds, alarm "P20" occurs even when the error count is less than 10. At this time, operation stops and does not restart.
- (7) For 30 minutes or longer after the compressor restarts, the control value for "current release control" is reduced to 70 – 90%.

### Overcurrent protection control

- (1) If the overcurrent protection circuit detects abnormal current, the compressor is stopped. (Error count = 1.) The compressor then restarts after 3 minutes.
- (2) If compressor start/stop is repeated 4 times (error count = 4), alarm "P26," "P29," or "H01" (count = 2 in this case only) occurs. Operation stops and does not restart.

### Current release value shift control

- (1) This control is intended to improve compressor reliability by preventing continuous high-frequency operation under overload conditions when the outdoor air temperature is high, and by preventing intermittent operation through "control for prevention of high cooling loads."
- (2) The control value for "current release control" is corrected according to the outdoor air temperature (TO).  
Depending on the temperature, the control value is lowered to 55 – 90% for cooling operation, and to 85 – 98% for heating operation.

### Freeze prevention (low-temperature release) control

The below control is performed during cooling operation (including dehumidifying operation), using whichever of the indoor heat exchanger temperatures (E1 or E2) is lower. (See the figure below.)

- (1) If a temperature in the "J" area (operating frequency reduction and thermostat OFF area) is detected for 6 minutes, the compressor operating frequency is reduced.  
The compressor operating frequency is reduced every 30 seconds as long as the temperature remains within this area.
- (2) If the temperature is in the "K" area (operating frequency increase-prohibit area), the compressor operating frequency is maintained.
- (3) If the temperature is in the "H" area (operating frequency control area), and the outdoor air temperature is less than 32°C, the compressor maximum operating frequency is limited according to the indoor unit fan speed.
- (4) If the temperature is in the "I" area (normal operating area), the compressors operate normally.
- (5) If the temperature is continuously in the "J" area and the compressor operating frequency reaches 0, then temperature A (temperature for changing from "J" area to "H" area) is raised from 5°C to 12°C, and operation continues with the thermostat OFF until the temperature reaches the "H" area.

### Heating high-load control

The below control is performed during heating operation, based on the indoor heat exchanger temperature (E2).

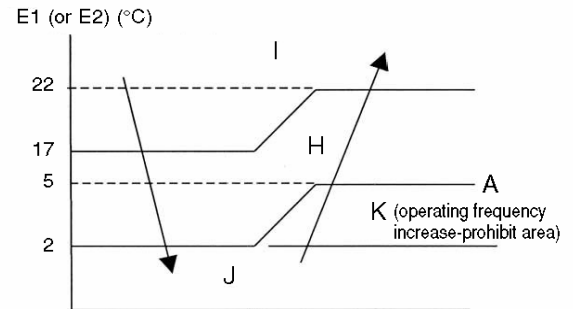

- (1) If the temperature is in the "M" area (operating frequency reduction and thermostat OFF area), the compressor operating frequency is reduced. The compressor operating frequency is reduced every 30 seconds as long as the temperature remains within this area.
- (2) If the temperature is continuously in the "M" area, the thermostat turns OFF.
- (3) If the temperature is in the "N" area, operating frequency increases are prohibited.
- (4) If the temperature is in the "L" area, the operating frequency is raised to the original frequency (the frequency prior to frequency reduction) by 6 Hz every 60 seconds.

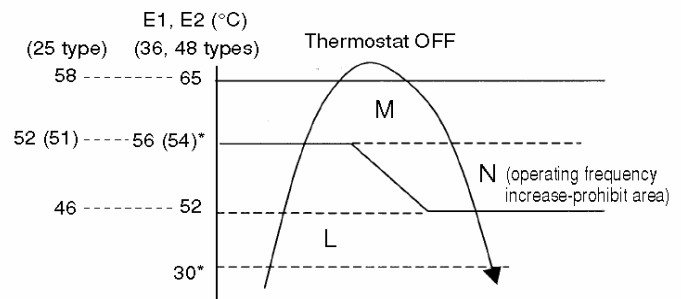

- \* When the compressor turns ON and the E2 temperature rises, the temperature at which the "M" area is first entered is 54°C (36, 48 types) or higher than 51°C (25 type).  
If the E1, E2 temperature subsequently falls to the "L" area, the temperature for entering the "M" area is raised to 56°C (36, 48 types) or 52°C (25 type). However if the E1, E2 temperature falls to the "L" area and falls below 30°C, then the temperature for entering the "M" area is changed back to 54°C (36, 48 types) or 51°C (25 type).

## Defrost control

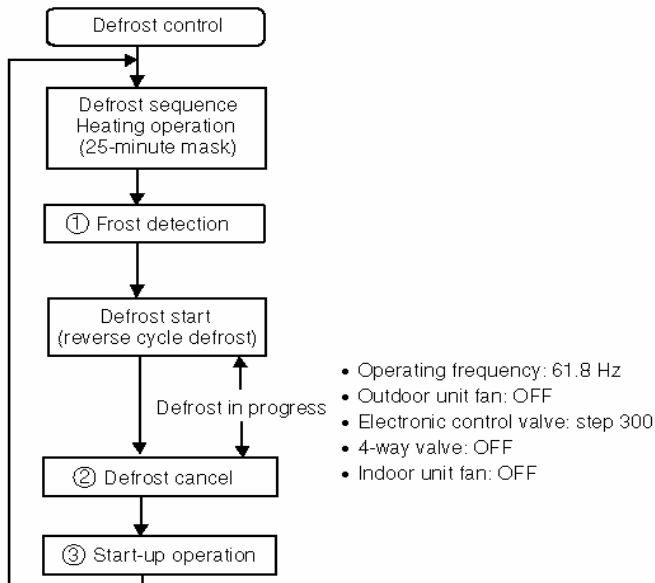

### (1) Frost detection

1. Outdoor heat exchanger temperature (C1) method  
(15-minute mask after operation start)

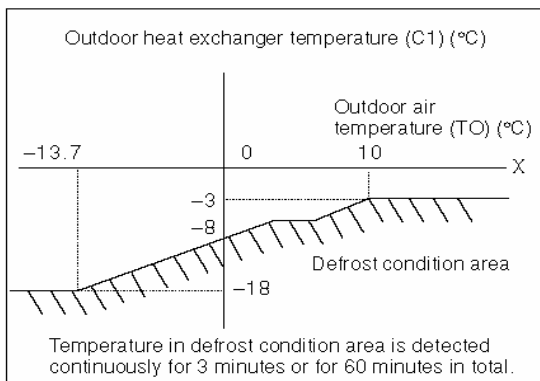

2. Outdoor air temperature is  $-13^{\circ}\text{C}$  or above and outdoor heat exchanger temperature (C1) of  $-18^{\circ}\text{C}$  or below is detected continuously for 20 seconds.
3. Outdoor air temperature is below  $-13^{\circ}\text{C}$  and outdoor heat exchanger temperature (C1) of below (outdoor air temperature  $- 5^{\circ}\text{C}$ ) is detected continuously for 20 seconds.

### (2) Defrost cancel

#### • Defrost end conditions

1. Outdoor heat exchanger temperature (C1) rises to  $12^{\circ}\text{C}$  or higher.
2. Outdoor heat exchanger temperature is  $7^{\circ}\text{C}$  or higher continuously for 1 minute.
3. Defrost time of 10 minutes has elapsed.

### (3) Startup operation

After defrost ends, the compressors and outdoor unit fan stop for approximately 40 seconds, then operation begins in heating mode.

# 5. REPLACING PCB

## 5-1 Replacing PCB

Replace the PCB by following the instructions “How to Replace Indoor Unit Control PCB” on the next page. Pay special attention to the following points:

- (1) Before replacing the indoor unit PCB, be sure to turn off the power source (at mains).
- (2) When replacing the PCB for an indoor unit, be sure to install the EEPROM that was attached to the original indoor unit PCB.
- (3) Some connectors (such as PNL and FS) on the PCB may include jumper wires. When removing the PCB of a malfunctioning indoor unit, disconnect these wires together with the EEPROM, and install them onto the new PCB.
- (4) Be careful when handling the EEPROM, as its pins are easily bent.
- (5) Securely install the EEPROM in the location and orientation shown in the figure below.
- (6) The alarm message (F29) may not necessarily appear immediately in cases of malfunctions in the EEPROM. Please monitor for a while after turning it on.

### About EEPROM

(Erasable Programmable Read-Only Memory)

EEPROM is a component in which the various information necessary for functioning can be electronically written or erased. This component holds informations that is essential for the running of the unit, and must be handled with care.

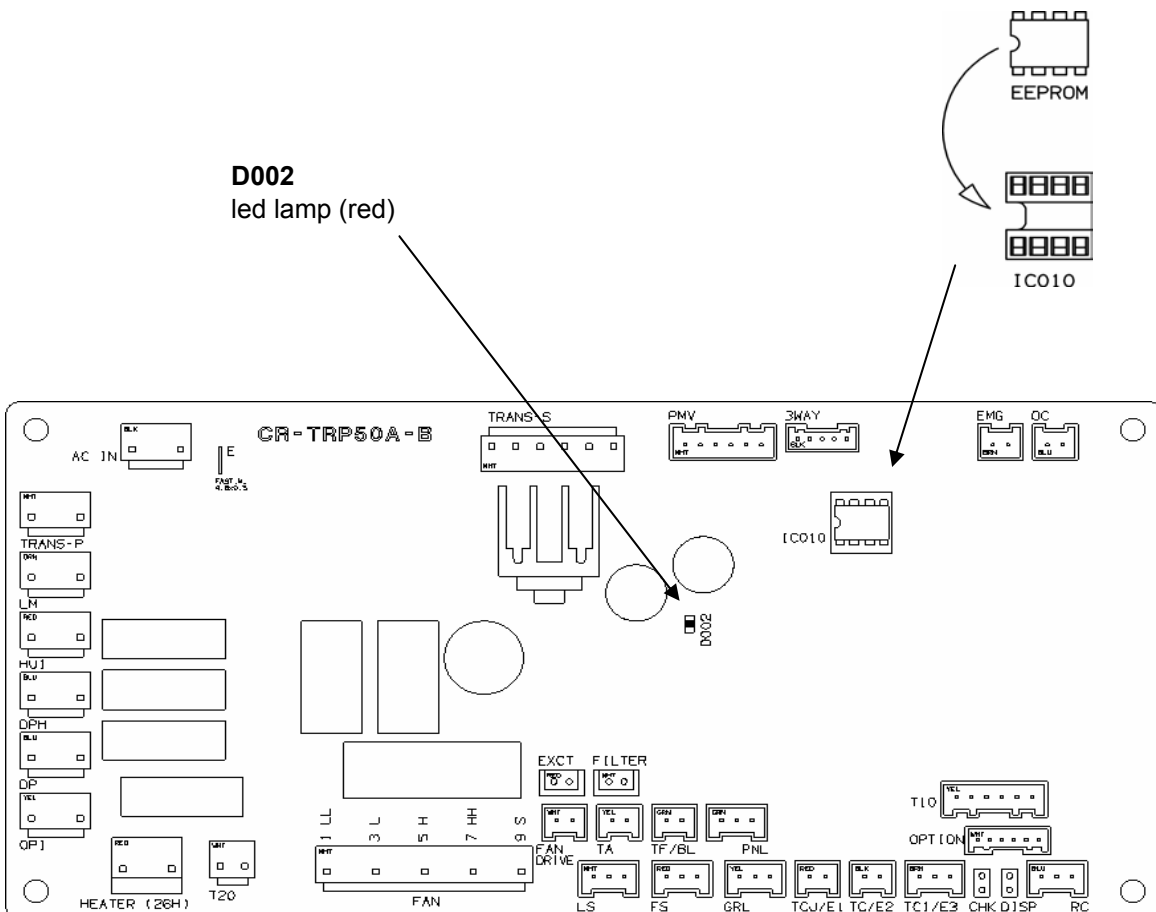

## 5-2 How to replace PCB

The settings data for the indoor unit are stored in the EEPROM (IC010) on the indoor unit control PCB. When replacing a PCB, remove the EEPROM from the malfunctioning PCB and re-install it on the new PCB.

In some cases the EEPROM itself may be damaged. Check the EEPROM using the procedure below. In addition, depending on the model, some connectors (such as PNL and FS) on the original PCB may include jumper wires. Disconnect these wires together with the EEPROM, and install them onto the new PCB.

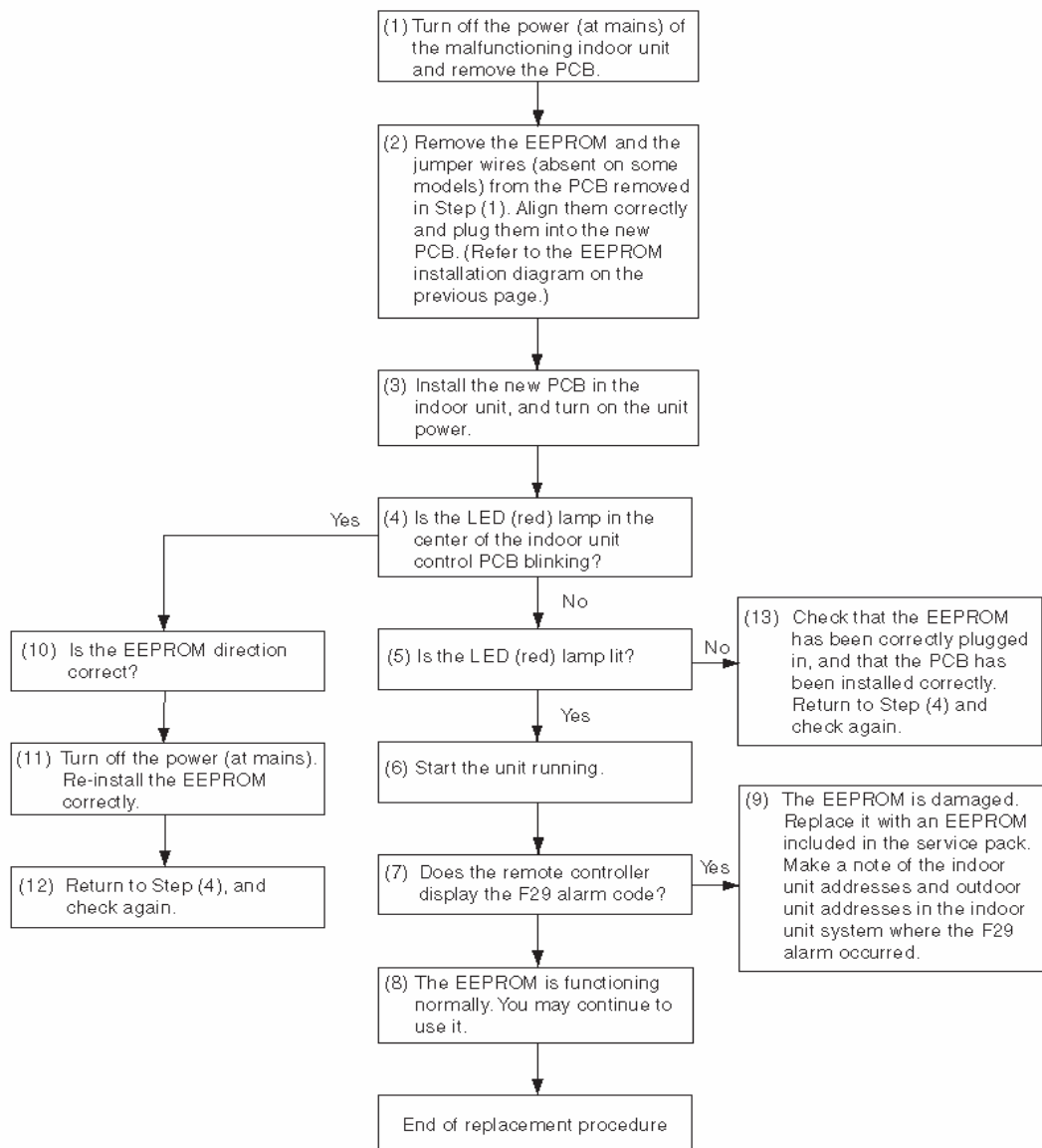

## 5-3 How to replace EEPROM with EEPROM included in PCB service pack

It is necessary to store the address, type (model type), and capacity into the new EEPROM if you have replaced the old one with the EEPROM in this PCB service pack. You can program the memory settings through the remote controller. In some cases the EEPROM may be damaged. Additionally check the EEPROM using the procedure below.

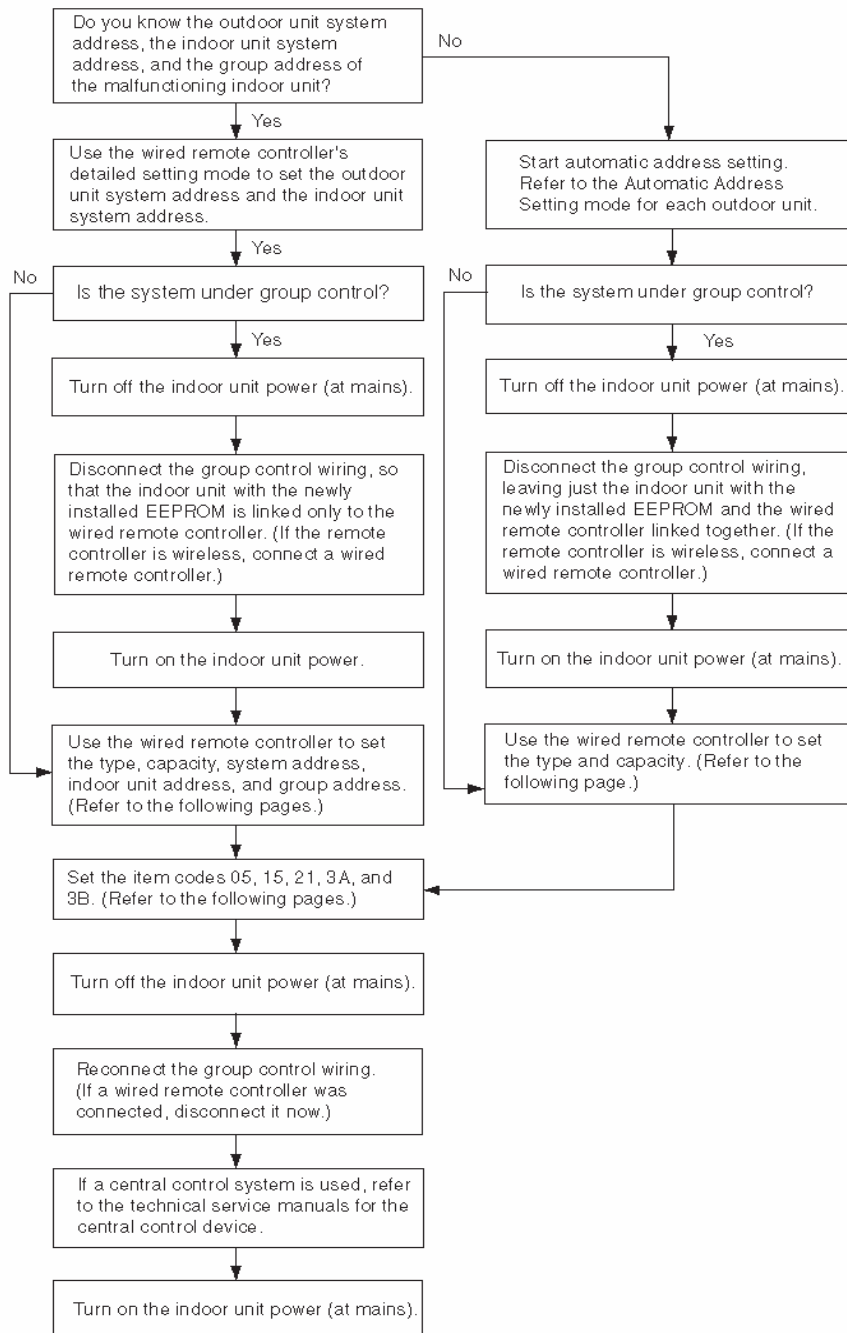

## Using the Remote Controller to Manually Set the Type, Capacity, System Address, and Group Address (Detailed Setting Mode)

[Function] Set up the indoor unit with the newly installed EEPROM so that it is linked only to the wired remote controller. Then in Detailed Setting Mode, set the type, capacity, system address, indoor unit address, and group address.

[Procedure] Stop operation of the unit before following these steps.

1. Press and hold the **SET**, **CL**, and **!** buttons simultaneously for 4 seconds or longer. Check that the remote controller display shows **SETTING** blinking.
2. The remote controller display shows "CODE No. 10" and "SET DATA 0001" blinking.
  - (1) When group control is engaged, press the **UNIT** button, and select the indoor unit address. (The indoor unit fan that corresponds to the address displayed in the "UNIT No." section will then start up.)
3. Set the indoor unit type.
  - (1) Using the Timer Setting **▲** or **▼** button, change the setting so that it matches the indoor unit type. (Refer to the "Table of Settings" on the next page.)
  - (2) Press the **SET** button. (The display stops blinking then lights. The setting procedure is completed.)
4. Set the indoor unit capacity.
  - (1) Using the Temperature Setting **▲** or **▼** button, change the display to "CODE No. 11."
  - (2) "SET DATA 0099" is displayed.
  - (3) Using the Timer Setting **▲** or **▼** button, change the setting so that it matches the indoor unit capacity.
  - (4) Press the **SET** button. (The display stops blinking then lights. The setting procedure is completed.)
5. Set the system address.
  - (1) Using the Temperature Setting **▲** or **▼** button, change the display to "CODE No. 12."
  - (2) "SET DATA 0099" is displayed.
  - (3) Using the Timer Setting **▲** or **▼** button, change the setting so that it is the same as the system address of the outdoor units in the same refrigerant system.
  - (4) Press the **SET** button. (The display stops blinking then lights. The setting procedure is completed.)
6. Set the indoor unit address.
  - (1) Using the Temperature Setting **▲** or **▼** button, change the display to "CODE No. 13."
  - (2) "SET DATA 0099" is displayed.
  - (3) Using the Timer Setting **▲** or **▼** button, change the setting so that it is the same as the address number of that indoor unit before the PCB was replaced. (Caution: No two units may have the same address numbers.)
  - (4) Press the **SET** button. (The display stops blinking then lights. The setting procedure is completed.)
7. Set the group settings.
  - (1) Using the Temperature Setting **▲** or **▼** button, change the display to "CODE No. 14."
  - (2) "SET DATA 0099" is displayed.
  - (3) Using the Timer Setting **▲** or **▼** button, change the setting so that it matches the group address number before the PCB was replaced.
  - (4) Press the **SET** button. (The display stops blinking then lights. The setting procedure is completed.)
8. Adjust the settings for other item codes in the same way. (Refer to the "Table of Settings.")
9. Press **!** to return to normal unit stopped status.

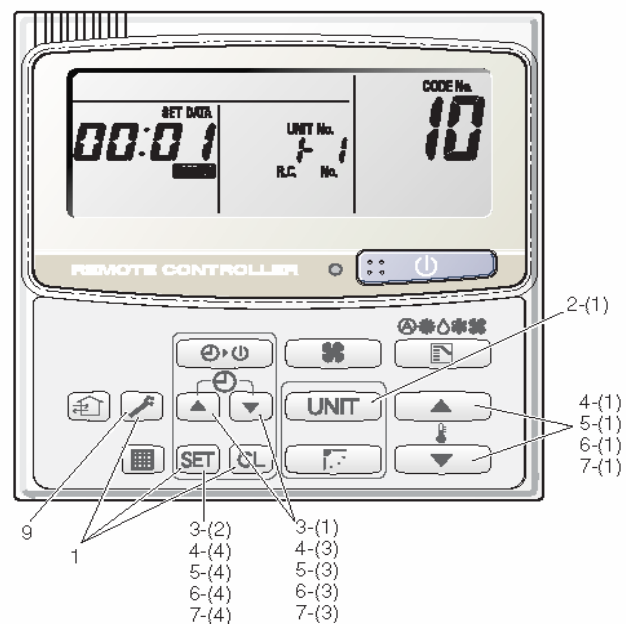

## 5-4 Table of settings

Item Code	Item	Setting Data					
		No.	Meaning	No.	Meaning	No.	Meaning
10	Type	0000	1-Way Air Discharge Semi-Concealed	0001	4-Way Air Discharge Semi-Concealed	0002	2-Way Air Discharge Semi-Concealed
		0003	1-Way Air Discharge Semi-Concealed Slim	0005	Concealed-Duct	0006	Concealed-Duct High Static Pressure
		0007	Ceiling-Mounted	0008	Wall-Mounted	0010	Floor-Standing
		0011	Concealed-Floor-Standing				
11	Indoor Unit Capacity kW	0000	Invalid	0001	2.2 (Type 74)	0003	2.8 (Type 94)
		0005	3.6 (Type 124)	0007	4.5 (Type 164)	0009	5.6 (Type 184)
		0010	6.3 (Type 224)	0012	7.3 (Type 254)	0015	10.6 (Type 364)
		0017	14.0 (Type 484)				
12	(Outdoor Unit) System Address	0001	Unit No. 1				
		0002	Unit No. 2				
		:	:				
		0030	Unit No. 30				
13	Indoor Unit Address	0001	Unit No. 1				
		0002	Unit No. 2				
		:	:				
		0064	Unit No. 64				
14	Group Address	0000	Individual Unit				
		0001	Main Unit				
		0002	Sub Unit				
05	Fan Speed (Heater Thermostat off)	0002	Compressor On: Fan speed LL Compressor Off: Fan speed LL				
15	Temperature Sensor Setting	0031	All Sensors Set to "On"				
21	Maximum Temperature Setting for Heating	0030	30°C				
3A	Air Outlet Temperature Control Feature	0000	No				
		0001	Yes				
3B	RAP Valve Feature	0000	No				
		0001	Yes (invalid)				

# 6. SERVICE PROCEDURE

## 6-1 Meaning of alarm message

ON: ○ Blinking: ☀ OFF: ●

Possible cause of malfunction			Wired remote control display	Wireless remote controller receiver display		
				Operation	Timer	Standby for heating
Serial communication errors Mis-setting	Remote controller is detecting error signal from indoor unit	Error in receiving serial communication signal (Signal from main indoor unit in case of group control) Outdoor system address, indoor system address, or indoor unit individual/main/sub setting is not set (Automatic address setting is not completed) Auto address is not completed	E01			
		Error in transmitting serial communication signal	E02	☀	●	●
	Indoor unit is detecting error signal from remote controller (and system controller)		E03			
	Improper setting of indoor unit or remote controller	Indoor unit address setting is duplicated	E08			
		Remote controller setting is duplicated	E09			
	Indoor unit is detecting error signaled from signal option	Error in transmitting serial communications signal	E10			
		Error in receiving serial communications signal	E11			
	Setting error	Main unit duplication in simultaneous-operation multi control (detected by outdoor unit)	E14			
	Indoor unit is detecting error signaled from outdoor unit	Error in receiving serial communications signal	E04			
		Error in transmitting serial communications signal	E05			
	Outdoor unit is detecting error signaled from indoor unit	Error in receiving serial communications signal (including unit quantity verification failure)	E06	●	●	☀
		Error in transmitting serial communications signal	E07			
	Automatic address setting failed	Indoor unit capacity too low	E15			
Indoor unit capacity too high		E16				
No indoor units connected		E20				
An indoor unit detected trouble in the signal from another indoor unit	Error in transmitting serial communications signal	E17	☀	●	●	
	Error in receiving serial communications signal	E18				
Communications trouble between units	Communications failure with MDC	E31	●	●	☀	
Mis-setting	Setting error	Indoor unit group settings error	L01			
		Indoor/outdoor unit type mismatch	L02	☀	●	☀
		Main unit duplication in group control (detected by indoor unit)	L03	☀	○	☀
		Outdoor unit address duplication (system address)	L04	☀	○	☀
		Group wiring connected for independent indoor unit	L07	☀	○	☀
		Address not set or group not set	L08	☀	●	☀
		Indoor unit capacity not set	L09	☀	○	☀
		Outdoor unit capacity not set or setting error	L10	☀	○	☀
		Miswiring in group control wiring	L11	☀	○	☀
		Indoor unit type setting error (capacity)	L13			

ON: ○ Blinking: ☀ OFF: ●

Possible cause of malfunction			Wired remote control display	Wireless remote controller receiver display		
				Operation	Timer	Standby for heating
Ceiling panel connection failure			P09			
Activation of protective device	Indoor protection	Fan protective thermostat	P01	●	☀	☀
		Float switch	P10	☀	☀	☀
	Outdoor protection	Discharge temperature trouble	P03			
		Open phase detected, AC power trouble	P05			
		No gas	P15			
		4-way valve locked	P19			
		High cooling load	P20	☀	●	☀
		Outdoor fan trouble	P22			
		Inverter compressor trouble (HIC PCB)	P26			
		Inverter compressor trouble (MDC)	P29			
		Simultaneous-operation multi control trouble	P31			
Compressor current failure (overload)	H01	●	☀	●		
Thermistor fault	Thermistor open circuit • Short circuit (indoor)	Indoor heat exchanger temperature sensor (E1)	F01	☀	☀	●
		Indoor heat exchanger temperature sensor (E2)	F02	☀	☀	●
		Indoor temperature sensor	F10	☀	☀	●
	Thermistor open circuit • Short circuit (outdoor)	Discharge temperature (TD)	F04			
		Outdoor heat exchanger temperature (C1)	F06			
		Outdoor heat exchanger temperature (C2)	F07	☀	☀	○
		Outdoor air temperature (TO)	F08	☀	☀	○
		Intake temperature (TS)	F12			
		Indoor EEPROM error	F29	☀	☀	●
		Outdoor EEPROM error	F31	☀	☀	○

## 6-2 Led indicator messages on outdoor control PCB

	LED 1	LED 2	Remarks
<b>Power ON sequence</b> 1. No communication from indoor units in system 2. Communication received from 1 or more indoor units in system 3. Regular communication OK (Capacity and unit quantity match)	○ ● ●	○ ○ ●	If it is not possible to advance to 3, repeats 1 → 2. At 3, changes to normal control.
<b>Normal operation</b> EEPROM error (F31)  Pre-trip (insufficient gas) Pre-trip (P20) Pre-trip (other)	○  ☀ (0.25/0.75) ☀ (0.75/0.25) ☀	☀  ● ● ●	Displayed during automatic address setting 1 and initial communication. After these are completed, alarm F31 is displayed.  <b>P03</b>
<b>Alarm</b>	<b>Alternate blinking during alarms</b> LED 1 blinks M times, then LED 2 blinks N times. The cycle then repeats. M = 2: P alarm 3: H alarm 4: E alarm 5: F alarm 6: L alarm N = Alarm No. * Refer to "1. Examples of alarm display" below.		
<b>Insufficient gas indicator</b>	☀	●	
<b>Refrigerant recovery mode</b>	☀	●	
<b>Automatic address setting</b> Automatic address setting in progress Automatic address setting alarm (E15) Automatic address setting alarm (E20) Automatic address setting alarm (Other than E15 and E20)	☀ ☀ (0.25/0.75) ☀ (0.75/0.25) ☀	☀ ☀ (0.25/0.75) ☀ (0.75/0.25) ☀	Blinking alternately Blinking simultaneously Blinking simultaneously Blinking simultaneously

- : ON
- ☀ : **Blinking (0.25/0.75)** indicates that the lamp illuminates for 0.25 seconds, and then is OFF for 0.75 seconds. Unless otherwise indicated, the blinking is (0.5/0.5).
- : OFF

Examples of alarm display (other than E15, E16, and E20)

Alarm / Display	LED 1 ← Alternately → LED 2
<b>P03</b>	☀ (Blinks 2 times)      ☀ (Blinks 3 times)
<b>P04</b>	☀ ( " )      ☀ (Blinks 4 times)
<b>P05</b>	☀ ( " )      ☀ (Blinks 5 times)
<b>P31</b>	☀ ( " )      ☀ (Blinks 31 times)
<b>H01</b>	☀ (Blinks 3 times)      ☀ (Blinks 1 times)
<b>H02</b>	☀ ( " )      ☀ (Blinks 2 times)
<b>H03</b>	☀ ( " )      ☀ (Blinks 3 times)
•	•
<b>E04</b>	☀ (Blinks 4 times)      ☀ (Blinks 4 times)
•	•
<b>F07</b>	☀ (Blinks 5 times)      ☀ (Blinks 7 times)
•	3
<b>L13</b>	☀ (Blinks 6 times)      ☀ (Blinks 13 times)
•	•

Note:  
This table shows example alarms. Other alarms may also be displayed.

## 6-3 Symptoms and parts to inspect

Remote controller alarm display	Alarm contents	Judgment condition	Clear condition	Judgment and correction
P03	Abnormal discharge temperature • Discharge temp. detected at or above the specified value.	Stops when temp. exceeds 111°C.	Recovery at restart	1. Check refrigerant cycle (gas leak). 2. Electronic control valve trouble 3. Check tubing sensor (TD).
P05	Missing phase detected. (CT disconnected or AC power trouble)	Current value sent from MDC on outdoor unit control PCB is low. No AC power input for 3 minutes or longer. pre-trip - 5	Recovery at restart	1. Check R/S/T power. 2. Check inverter control PCB. 3. Check outdoor unit control PCB.
P15	Insufficient gas level detected.	The following conditions continue for 1 minute. • Discharge temp. is 95°C or higher. • Electronic control valve is at step 480. • Current value from MDC is 1.7 A (3-phase) or 1.0 A (1-phase) or less.	Recovery at restart	Check refrigerant cycle (gas leak).
P19	4-way valve locked • Judgment occurs after compressor has been ON for 5 minutes.	Indoor heat exchanger temp. drops although compressors are ON in heating mode: [min(E1, E2)] ≤ 10°C. Indoor heat exchanger temp. rises although compressors are ON in cooling mode: E2 ≥ 40°C	Recovery at restart	1. Check 4-way valve. 2. Check 4-way valve wiring. 3. Check outdoor unit control PCB.
P20	High-pressure protection trouble detected from cooling high-load C2 temp.	Temp. exceeds 64°C and subsequently does not drop to 55°C or below. • Continuously for 30 seconds → Alarm is output when this occurs once • Continuously for less than 30 seconds → Inverter stops.	Recovery at restart	1. Refrigerant cycle overload operation 2. Outdoor coil temperature sensor C2
P22	Outdoor unit fan motor trouble • Inverter protection circuit was activated, or lock was detected, at outdoor unit fan motor.	Inverter stops after alarm is detected	Recovery at restart	1. Position detection trouble 2. Overcurrent protection circuit at outdoor unit fan motor was activated. • Check outdoor unit control PCB • Refer to outdoor unit fan judgment methods.
P26	Inverter protection circuit was activated, or G-Tr short-circuit (short time: 0.8 s or less) in inverter control	Inverter stops after alarm is detected. Alarm is output when inverter stops (pre-trip) consecutively 4 times.	Recovery at restart	1. Stops immediately when restarted. • Layer short in the compressor 2. Check inverter control PCB. • Wiring trouble

Remote controller alarm display	Alarm contents	Judgment condition	Clear condition	Judgment and correction
P29	Current detection circuit trouble • AC current value is high even when compressor is stopped.	Inverter stops after alarm is detected. Alarm is output when inverter stops (pre-trip) consecutively 4 times.	Recovery at restart	1. Stops immediately when restarted. • Layer short in the compressor 2. Check inverter control PCB. • Wiring trouble
	Compressor motor output trouble, Inverter compressor trouble, MDC trouble	Inverter stops after alarm is detected.	Recovery at restart	1. Refrigerant cycle trouble, overload operation 2. Loose screws and contact failure between HIC control PCB and radiating plate 3. Cooling failure of radiating plate 4. Check outdoor unit PCB wiring.
	Compressor does not run. (Overcurrent protection circuit activates after a certain period of time following compressor start.)	Inverter stops after alarm is detected.	Recovery at restart	1. Compressor trouble (locked, etc.) • Replace the compressor. 2. Compressor wiring trouble (missing phase)
	Compressor breakdown • Starts to operate but operating frequency drops and compressor stops.	Inverter stops after alarm is detected.	Recovery at restart	1. Check power voltage: AC 200 V ± 20 V. 2. Refrigerant cycle overload operation 3. Check AC current detection circuit.
	Inverter control PCB position detection circuit trouble	Inverter stops after alarm is detected.	Recovery at restart	Position detection circuit is activated even when the compressor 3P connector is disconnected and the compressor operated. • Replace the inverter control PCB.
F04	Disconnection, open circuit, or short circuit in discharge temp. sensor (TD)	Sensor detection trouble (90°C or higher when 15 minutes have elapsed after compressor stopped). (Open circuit)	Automatic recovery	1. Check discharge temp. sensor (TD). 2. Check outdoor unit control PCB.
F06	Disconnection, open circuit, or short circuit in outdoor heat exchanger temp. sensor (C1)	Open circuit or short circuit	Automatic recovery	1. Check outdoor heat exchanger temp. sensor (C1). 2. Check outdoor unit control PCB.
F07	Disconnection, open circuit, or short circuit in outdoor heat exchanger temp. sensor (C2)	Open circuit or short circuit	Automatic recovery	1. Check outdoor heat exchanger temp. sensor (C2). 2. Check outdoor unit control PCB.
F08	Disconnection, open circuit, or short circuit in outdoor air temp. sensor (TO)	Open circuit or short circuit	Automatic recovery	1. Check outdoor air temp. sensor (TO). 2. Check outdoor unit control PCB.
F12	Disconnection, open circuit, or short circuit in intake temp. sensor (TS)	Open circuit or short circuit	Automatic recovery	1. Check intake temp. sensor (TS). 2. Check outdoor unit control PCB.

Remote controller alarm display	Alarm contents	Judgment condition	Clear condition	Judgment and correction
F31	EEPROM trouble	Reading/writing failure	Recovery at power reset	1. Check EEPROM (IC901). 2. Check outdoor unit control PCB.
L02	Mismatch of indoor and outdoor unit types (Espacio, Multi, GHP)	Indoor unit judges that type does not match outdoor unit type.	Recovery at power reset	1. Check indoor unit EEPROM. 2. Check indoor unit control PCB.
L04	Settings failure	Duplicated outdoor unit address (system address)	Automatic recovery	1. Check outdoor unit system address. 2. Check inter-unit control wiring.
L07	Settings failure	Group control wiring is connected to an independent-control indoor	Recovery at power reset	1. Check inter-unit control wiring. 2. Check indoor unit EEPROM.
L10	Settings failure	Outdoor unit capacity not set.	Recovery at power reset	Check outdoor unit EEPROM.
L13	Indoor-outdoor unit types	Outdoor unit judges that type does not match indoor unit type.	Recovery at power reset	1. Check indoor unit EEPROM. 2. Check outdoor unit control PCB.
E06	Outdoor unit detected abnormal signal from indoor unit.	Serial signal receiving failure (including failure to verify No. of units)	Automatic recovery	1. Check inter-unit control wiring. 2. Check outdoor unit
E07	Outdoor unit sending failure to indoor unit	Serial signal sending failure	Automatic recovery	1. Check inter-unit control wiring. 2. Check outdoor unit control PCB.
E14	Settings failure	Duplicated master unit in simultaneous-operation multi control (Detected by outdoor unit)	Recovery at power reset	1. Check inter-unit control wiring. 2. Check indoor unit combination.
E15	Automatic address setting failure	Indoor unit capacity too low.	Recovery at power reset	1. Check inter-unit control wiring. 2. Check outdoor unit control PCB.
E16	Automatic address setting failure	Indoor unit capacity too high.	Recovery at power reset	1. Check inter-unit control wiring. 2. Check outdoor unit control PCB.
E20	Automatic address setting failure	Outdoor unit cannot receive any serial signals from indoor units.	Recovery at power reset	1. Check inter-unit control wiring. 2. Check outdoor unit control PCB.
E31	Communications trouble within unit	No communication possible with MDC for 3 minutes or longer.	Automatic recovery	Check outdoor unit control PCB.
H01	Overcurrent	Inverter stops after alarm is detected.	Recovery at restart	1. Refrigerant cycle trouble, overload operation 2. Loose screws between HIC control PCB and radiating plate 3. Cooling failure of radiating plate 4. Check outdoor unit PCB wiring.

# 6-4 Details of alarm messages

**(1) [Alarm "P29"] (MDC trouble)**

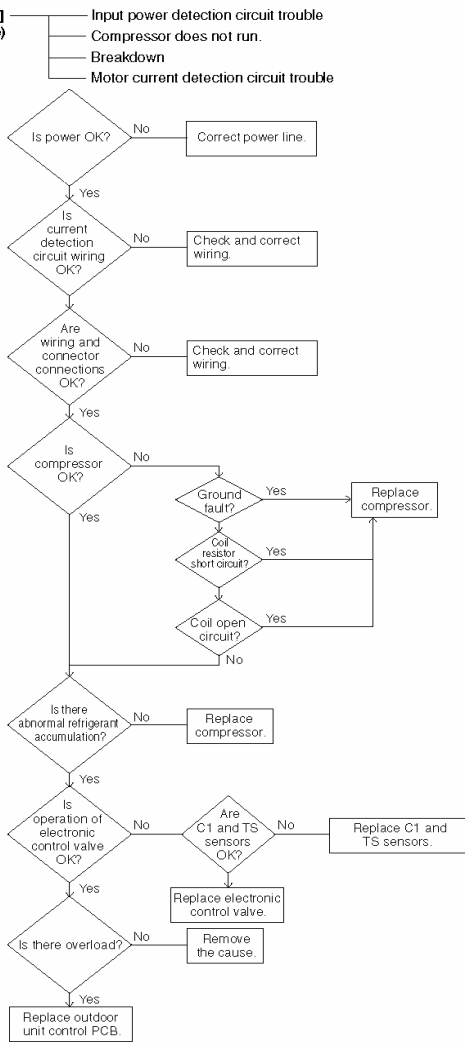

**(2) [Alarm "P26"] (IGBT short-circuit protection on inverter control (IPDU) PCB HIC PCB trouble)**

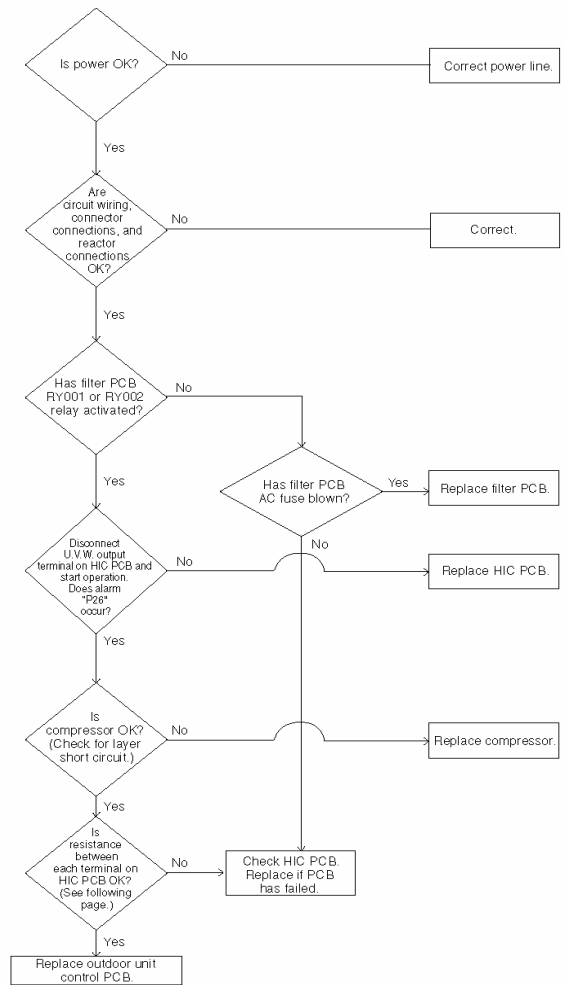

**CR-HIC280A (48 Type)**

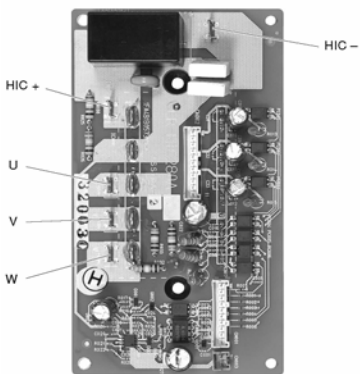

**CR-HIC80A (25, 36 Type)**

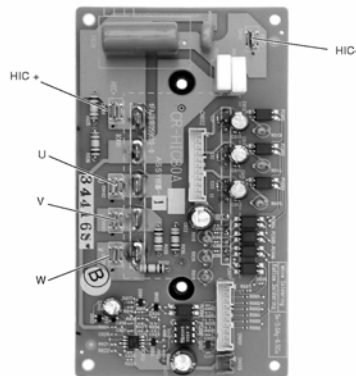

**resistance**

Between terminals	Resistance
HIC + — HIC -	200 kΩ or more
HIC + — U	300 kΩ or more
HIC + — V	300 kΩ or more
HIC + — W	300 kΩ or more
HIC - — U	200 kΩ or more
HIC - — V	200 kΩ or more
HIC - — W	200 kΩ or more

**(3) [Alarm "E31"] (communications trouble within unit)**

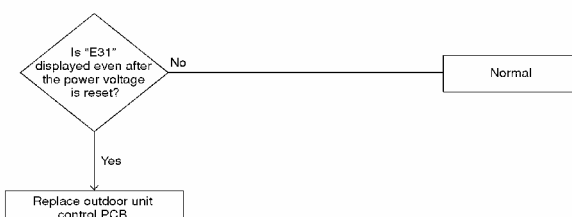

**(4) [Alarm "P22"]** ————— Outdoor unit fan motor drive circuit trouble

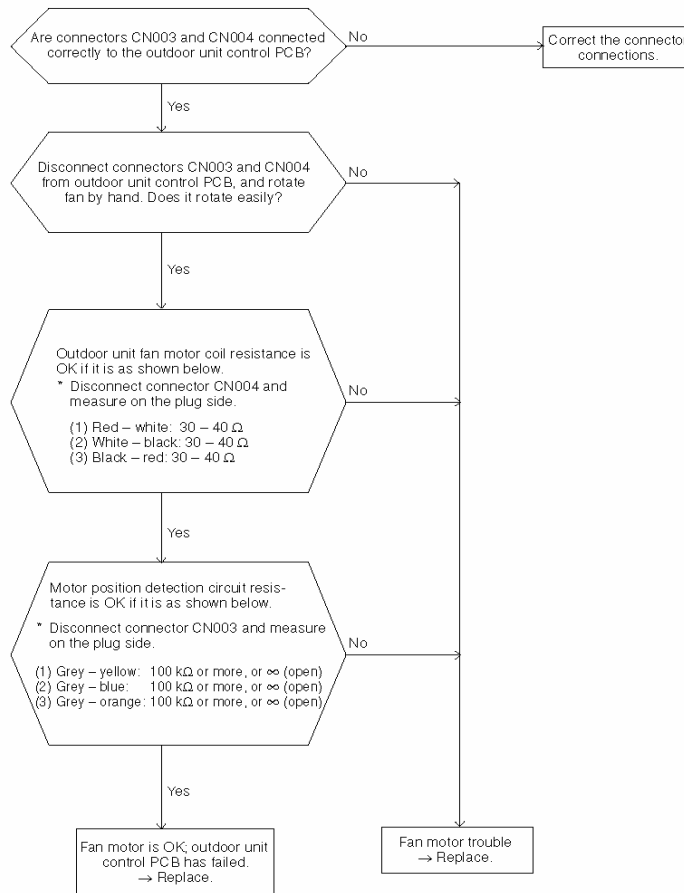

**Note:**  
 In the case of a GND circuit failure inside the motor, the results of the above check may be OK.  
 If operation is not OK after the outdoor unit control PCB has been replaced, then replace the outdoor unit fan motor.



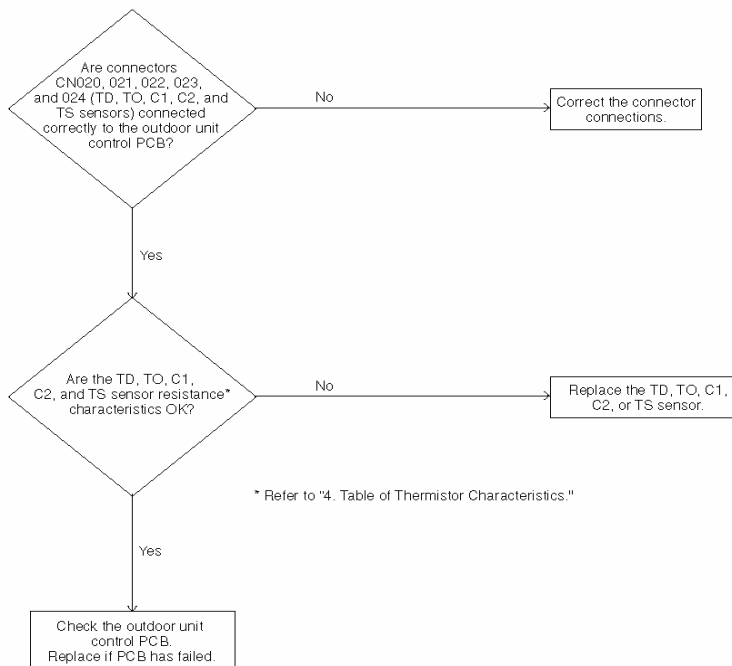



**(5) [Alarms "F04," "F06," "F07," "F08," "F12"]** ————— Sensor trouble



### Sensor Temperature Display Function (Displayed both when operating and stopped)

- The below check procedure can be used to display all remote controller, indoor unit, and outdoor unit sensor temperatures.

#### <Check procedure>

- (1) Press and hold the  button and  button simultaneously for 4 seconds or longer.
- (2) Unit No. X-X (main unit No.), item code XX (sensor address), and service monitor 00XX (sensor temperature) appear on the remote controller LCD. (See figure.)
- (3) Press the temperature setting  and  buttons and change the item code to the sensor address of the sensor that you want to monitor.  
(For the relationship between the sensor address and the sensor type, refer to the below Sensor Temperature Correlation Table.)
- (4) During group control and simultaneous-operation multi control, press the  button and change to the unit that you want to monitor.
- (5) Press the  button to return to normal remote controller operation.

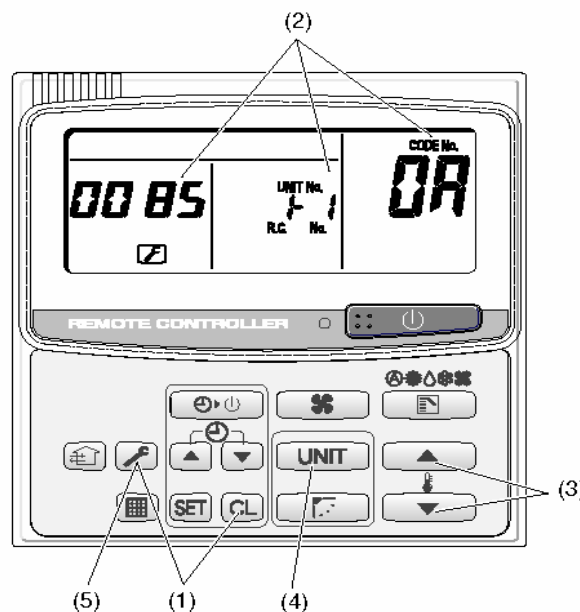

Figure: Sample display when discharge temperature at unit No. 1-1 is 85°C

#### NOTE

The temperature display reads “- - - -” for units that are not connected.

- \* If monitor mode is selected during normal operation, the only parts of the LCD that change are those shown in the figure. All other displays do not change, and remain as they were during normal operation.

### Sensor Temperature Correlation Table

Sensor installation location	Sensor address	Sensor type	Sensor address	Sensor type
Indoor unit	00	Room temp. (temp. used for control)*	05	-
	01	Remote controller temp.	06	Discharge temp.
	02	Indoor intake temp.	07	-
	03	Indoor heat exchanger temp. (E1)	08	-
	04	Indoor heat exchanger temp. (E2)	09	-
Outdoor unit	0A	Discharge temp. (TD)	12	-
	0b	-	13	-
	0C	-	14	Current (AC current)
	0d	Intake temp. (TS)	15	Outdoor electronic control valve position
	0E	Outdoor heat exchanger temp. (C1)	16	-
	0F	Outdoor heat exchanger temp. (C2)	17	-
	10	-	18	-
11	Outdoor air temp.	19	-	

\* Main unit only when group control is enabled

### Check Pin

Short-circuit the cooling check pin (or heating check pin) on the outdoor unit control PCB to perform the control described below.

#### 1. Thermistor checks

The checks listed below are performed for 1 second each, in order from the top down. The results are displayed by LED 1 and 2.

Thermistor	Check results	
	Normal	Abnormal
Discharge temp. (TD)	LED 1 lit	LED 1 and 2 OFF
Outdoor air temp. (TO)	LED 2 lit	
Heat exchanger temp. (C1)	LED 1 lit	
Heat exchanger temp. (C2)		
Intake temp. (TS)	LED 1 lit	



#### 2. 4-way valve turns ON for 1 second.



#### 3. Forced cooling (or heating) operation

### 6-5. Table of Thermistor Characteristics

#### (1) Outdoor Air Temp. (TO), Intake Temp. (TS), Heat Exchanger Temp. (C1) Sensor, Heat Exchanger Temp. (C2) Sensor

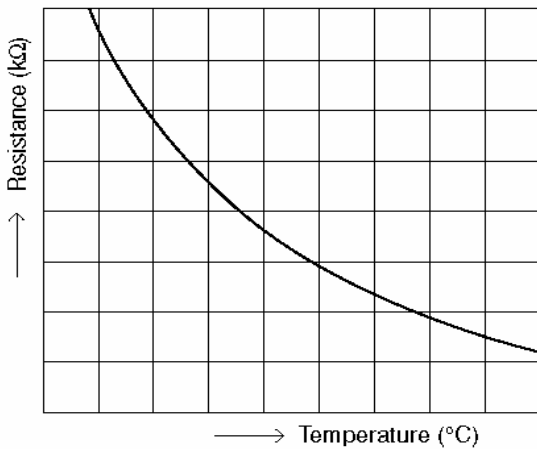

#### (2) Discharge Temp. (TD) Sensors

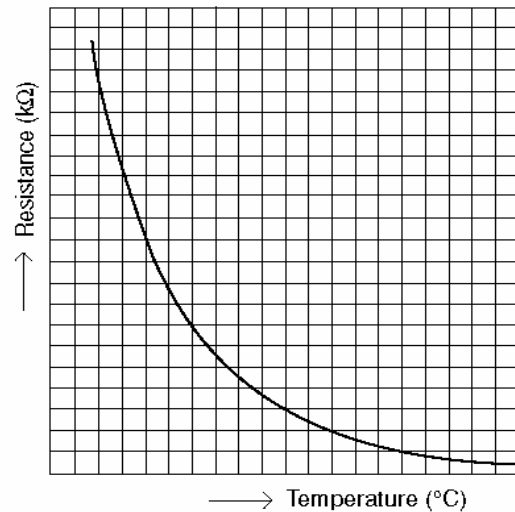

# 7. OUTDOOR UNIT MAINTENANCE REMOTE CONTROL

## 7-1. Overview

### What is the outdoor unit maintenance remote controller?

Beginning with the DC-INV series of outdoor units, nonvolatile memory (EEPROM) is used in the outdoor unit PCB. In this way, the setting switches that were located on earlier PCBs have been converted to EEPROM data. This remote controller is an outdoor unit maintenance tool that is used to make and change the EEPROM settings. This remote controller can be used for checking the outdoor unit EEPROM settings and contents, and also can be used to monitor the outdoor unit alarm history and indoor/outdoor unit temperatures, and to check the status of the indoor unit connections (No. of units, operating status, etc.).

**Note:** Because this tool does not function as a remote controller, it is used only during test runs and servicing.

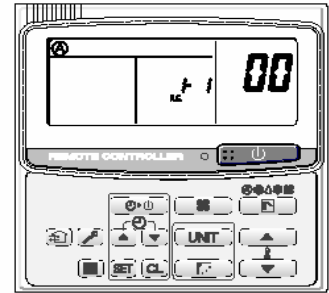

K70D036Z

### System diagram

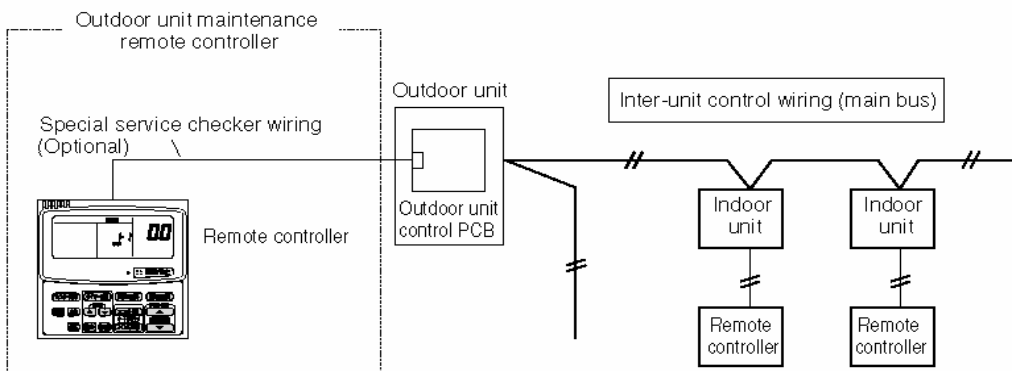

- \* The special service checker wiring is required in order to connect the outdoor unit maintenance remote controller to the outdoor unit PCB.
- \* Even when the outdoor unit maintenance remote controller is connected, a separate remote controller or other control device must be connected to the indoor unit.

## 7-2. Functions

### ■ Normal display functions

- (1) Functions: Button operations can be used to perform the following functions.
  - Start/stop of all indoor units
  - Switching between cooling and heating
  - Test run of all indoor units
  - High-speed operation of indoor units (Do not use with actual units. This may damage the devices.)
- (2) Display: The following can be displayed.
  - Alarm details display
  - No. of indoor/outdoor units
  - Unit Nos. of connected indoor/outdoor units
  - Indoor/outdoor unit operating status (blinks when an alarm occurs)
  - Indoor unit thermostat ON
  - Individual display of outdoor unit alarms
  - Outdoor unit compressor total operating time
  - Outdoor unit oil sensor oil level
  - Outdoor unit total power ON time
  - Outdoor unit microcomputer version
  - Other

### ■ Temperature monitor

- Displays the indoor/outdoor unit sensor temperatures.

### ■ Outdoor unit alarm history monitor

- Displays the outdoor unit alarm history.

### ■ Settings modes

- Settings mode 1 and settings mode 2 are used to make the outdoor EEPROM settings.

## 7-3. Normal Display Operations and Functions

### ■ Normal display functions

- Connect the special service checker wiring to the outdoor unit PCB. The connection is shown in the figure below.

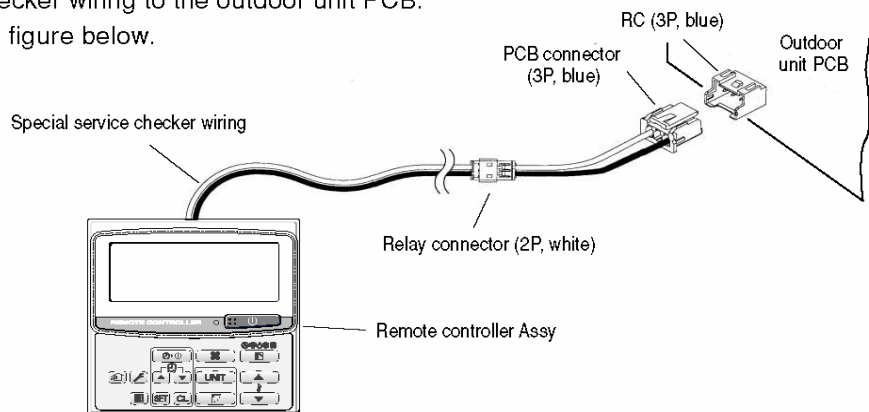

- \* It is not necessary to disconnect the communications line in the inter-unit control wiring if it has already been connected at this time.
- \* Settings modes 1 and 2 can be used even when the outdoor unit is independent (when 1 maintenance remote controller is connected to 1 outdoor unit and automatic address setting for the indoor units has not been completed).
- \* Displays the overall system status for that refrigerant system.

#### ● All units start/stop (Fig. 1)

<Operation>

The  button can be used to start and stop all the indoor units.

- The LED turns ON when 1 or more indoor units is operating.
- The LED blinks when an alarm has occurred at 1 or more indoor units during operation.

#### ● Switching between cooling/heating (Fig. 1)

<Operation>

The  button switches between heating and cooling modes.

- The specifications are equivalent to the heating/cooling input that was present on earlier outdoor unit PCBs.
- The display shows the operating mode of the indoor unit with the lowest number.

#### ● All units test run (Fig. 2)

<Operation>

The  button switches test run ON/OFF for all indoor units.

- Press and hold for 4 seconds to turn ON. "Test run" is displayed while the test run is in progress.
- Conditions of test runs that are started from the unit remote controller are not displayed on the outdoor unit maintenance remote controller.

#### ● High-speed operation (Fig. 3)

- Do not use with actual units. (The devices may be damaged.)

<Operation>

The time  button changes between high-speed operation and normal operation.

- During high-speed operation, the "repeat" timer mark  is displayed.

Fig. 1

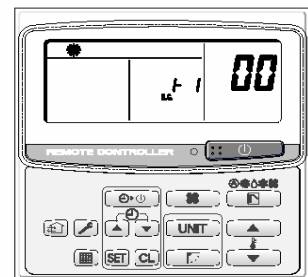

Fig. 2

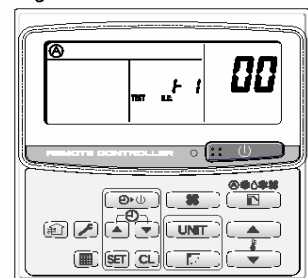
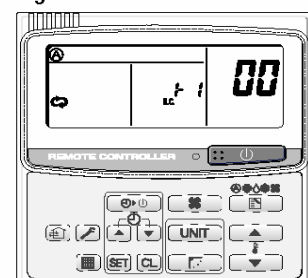



Fig. 3



## ■ Display (functions)

- Use the temperature setting  and  buttons to change the item code.

Item code	Display contents	Remarks
00 (1)	Outdoor unit alarm contents (code): OFF when normal Blinking 8-alarm code display at pre-trip, LED (2)	At initial status
01	No. of indoor units connected in that refrigerant system	
02	Unit Nos. of connected indoor units in that refrigerant system *2	
03	Operating status of indoor units in that refrigerant system (blinks when alarms occur) *2	
04	Unit Nos. of indoor units in that refrigerant system where the thermostats are ON *2	
05	No. of outdoor units connected in that refrigerant system	No. of connected units: 1
06	Unit Nos. of connected outdoor units in that refrigerant system *2	
07	Operating status of outdoor units in that refrigerant system (blinks when alarms occur) *2	
08		
09		
0A		
0b		
0C		
0d		
0E		
0F		
10	Total compressor operating time (in 1-hr. units) *3	
11		
12		
13		
14		
15		
16	Total power ON time of outdoor unit (in 1-hr. units)	
17	Compressor start count	
18		
19		
FE	Outdoor unit microcomputer firmware version	
FF	Outdoor unit microcomputer software version	

### (3) XX-YY system

Displays the outdoor unit address of the selected outdoor sub-bus.

XX = Main bus line outdoor system address (1 – 30)

YY = Outdoor unit address in outdoor sub-bus (1 – 8). This is "1" when there is only 1 outdoor unit.

#### <Sample displays>

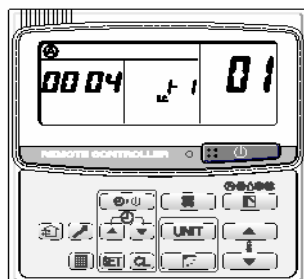

01: <No. of connected indoor units>  
4 units connected

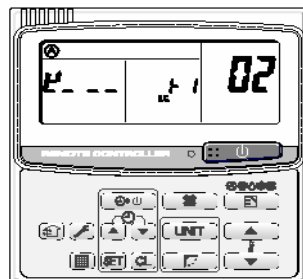

02: <Unit Nos. 1, 2, 3, and 4 are connected>

Locations where (1), (2), and (3) are displayed are shown below.

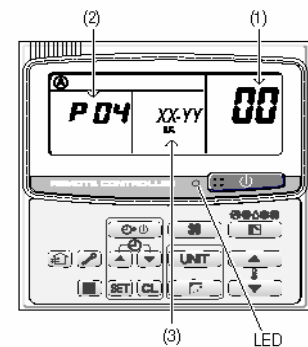

(3) LED

\* See following page for \*2 and \*3.

**\*2: 7-segment, 4-digit display for remote controller timer display**

The connected unit Nos. are displayed as shown below, using the 7-segment 4-digit (**BB : BB**) display and the colon.

- Display for unit Nos. 1 – 20

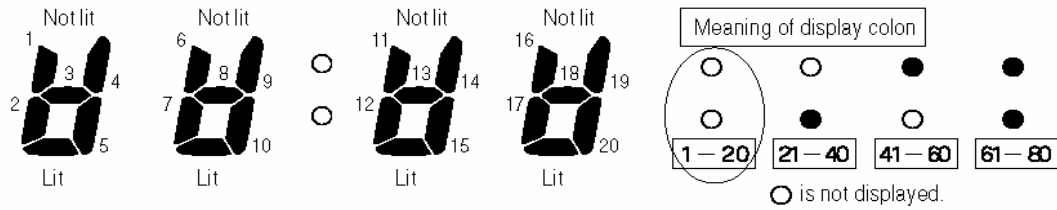

- Display for unit Nos. 21 – 40

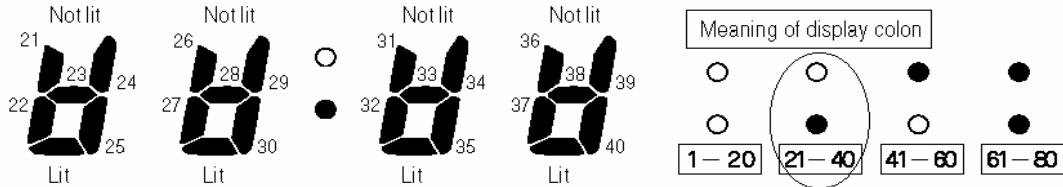

- The meaning of the colon display changes in the same way, allowing unit Nos. up to 80 to be displayed.
- Sample displays of the unit Nos. of connected indoor units

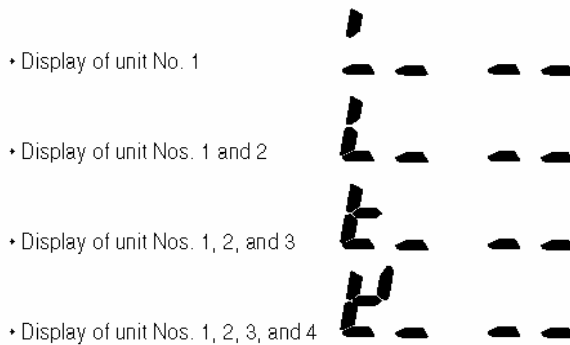

**NOTE**

The colon display changes automatically every 10 seconds.

(The display does not change if higher unit numbers do not exist.)

Pressing the button switches the display immediately to the next higher level, even if 10 seconds have not passed.

**\*3: The total compressor operating time is displayed (in 1-hour units) using 8 digits.**

- When the first 4 digits are displayed, the top point of the colon is lit.
- When the last 4 digits are displayed, the colon points are not lit.
- The display of the first 4 and last 4 digits changes automatically every 10 seconds. It can also be changed by pressing the button.

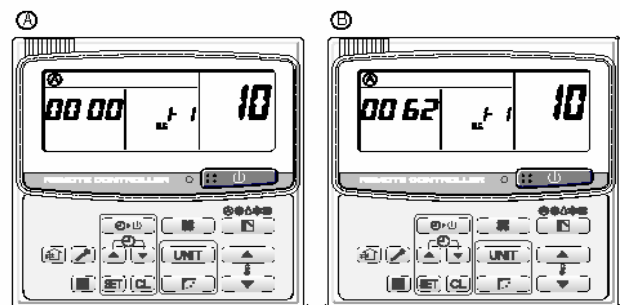







10: <Total compressor operating time> (A) and (B) are displayed alternately.

**NOTE**

With the outdoor unit maintenance remote controller (when connected to the outdoor unit), the unit remote controller check functions will not operate.

## 7-4. Monitoring Operations: Display of Indoor Unit and Outdoor Unit Sensor Temperatures

<Operating procedure>

- (1) Press and hold the  button and  button simultaneously for 4 seconds or longer to switch to temperature monitor mode.  
During temperature monitoring, "Service Monitor" is lit.  
(The display and operations are the same as when monitor mode is started from the unit remote controller.)
- (2) Press the  button and select the indoor unit to monitor.
- (3) Use the temperature setting  and  buttons to select the item code of the temperature to monitor.  
The selected indoor unit No. and the temperature data are displayed.
- (4) To end monitoring, press the  button. The display returns to the normal display.

\* The display does not blink.

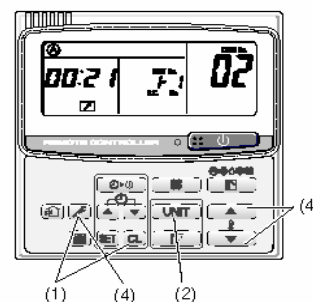

	Item code	Meaning of Code
Indoor unit data	02	Indoor unit intake temp.
	03	Indoor unit heat exchanger temp. (E1)
	04	Indoor unit heat exchanger temp. (E2)
	05	Indoor unit heat exchanger temp. (E3)
	06	Indoor unit discharge temp.
	07	–
	08	–
	09	
Outdoor unit data	0A	Discharge temp. (TD)
	0b	–
	0C	–
	0d	Intake temp. (TS)
	0E	Outdoor unit heat exchanger temp. (C1)
	0F	Outdoor unit heat exchanger temp. (C2)
	10	–
	11	Outdoor air temp. (TO)
	12	Heat sink temperature
	13	–
	14	Current value
	15	Outdoor MV value
	19	Frequency



\* Depending on the model, some items may not be displayed.

## 7-5. Monitoring the Outdoor Unit Alarm History: Display of Outdoor Unit Alarm History

\* Displays outdoor unit alarms only. Does not display indoor unit alarms.

\* Check the indoor unit alarm histories separately using the indoor unit remote controllers or other control device.

<Operating procedure>

- (1) Press and hold the  button and  button simultaneously for 4 seconds or longer to change to outdoor unit alarm history mode.



During the alarm history display, "Service Check" is lit.

The display and operations are the same as the monitoring of the alarm device history that is performed using the unit remote controller. However, the outdoor unit address appears instead of the unit No.



- (2) Press the  button and select the outdoor unit for alarm history monitoring.



- (3) Use the temperature setting  and  buttons to select the item code for the alarm history.

The display shows the address of the selected outdoor unit, the item code, and the alarm history (alarm data).

The outdoor unit address is displayed as system XX-YY.

System XX = Outdoor unit system address



YY = Outdoor unit sub-bus address

The item code is displayed as 01 – 08. 01 indicates the most recent alarm.

The alarm history is indicated by the alarm code. (If there have been no alarm codes, "----" is displayed.)

- (4) To clear the alarm history, press the  button. (The outdoor unit alarm history will be cleared.)



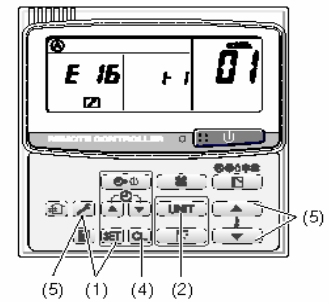

- (5) To end, press the  button. The display returns to the normal remote controller display.







## 7-6. Settings Modes: Setting the Outdoor Unit EEPROM

### ● Setting mode 1

<Operating procedure>

- (1) Press and hold the  button and  button simultaneously for 4 seconds or longer.

- (2) Use the temperature setting  and  buttons to change the item code. The item codes and setting data are shown in the table on the next page.

- (3) Use the timer time  and  buttons to change the setting data. To confirm the changed setting data, press the  button. (At this time, "Setting" stops blinking and remains lit.)

- (4) During this mode, "Setting" is displayed, blinking. The outdoor unit address display section displays "ALL," the item code and number (DN value in the table), and the setting data (6 digits).

(The setting data is displayed in 6 digits. The display changes between the first 3 digits (Fig. A) and the last 3 digits (Fig. B). When the first 3 digits are displayed, the top point of the colon is lit.)

- (5) To end the setting mode, press the  button.

Ⓐ Display of first 3 digits

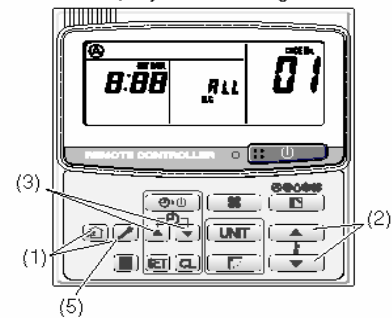

Ⓑ Display of last 3 digits

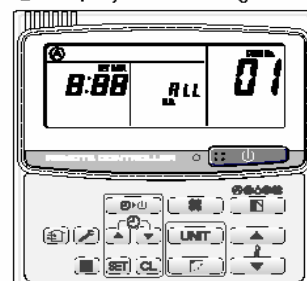

Ⓐ and Ⓑ are displayed alternately. (Example shows display of 000 001.)

## List of Item Codes

Item code	Parameter	
01	Control system schedule	
02	Control system schedule	
03	Control system schedule	
04	Snowfall sensor operation	0 = No sensor, control performed 1 = No sensor, control not performed 2 = Sensor present, control performed 3 = Sensor present, control not performed
05	Outdoor fan quiet mode	0 = Disabled      1 = Quiet mode
06	Defrost fan speed selection	0 = Disabled      1 = LL fan speed (This function is not present with the DC-INV.)
07	Ignore capacity	0 = Disabled      1 = Ignores capacity ratio
08	Control system schedule	
09	Control system schedule	
0A	Control system schedule	
0b	Control system schedule	
0C	Forced operation of indoor unit drain pump	0 = Disabled 1 = During cooling only, 2 hours stopped + 20 minutes operating (regardless of whether the unit is running or stopped) 2 = During cooling only, 4 hours stopped + 20 minutes operating (regardless of whether the unit is running or stopped) 3 = At all times, 4 hours stopped + 20 minutes operating 4 = At all times, 2 hours stopped + 20 minutes operating
0d	Odor countermeasure when indoor cooling thermostat is OFF	0 = Disabled      1 = Odor countermeasure is active
0E	Cool only	0 = Heat pump      1 = Cool only
0F	Control system schedule	
10	Control system schedule	
11	Multi-floor installation	0 = No      1 = Yes
12	Control system schedule	
13	Control system schedule	
50	Demand 1	40%, 45% ... 100% ... 160%
51	Demand 2	40%, 45% ... 100% ... 160%
52	Current control level	40%, 45% ... 100% ... 160%, -1 (no control)

\* Figures in parentheses indicate the data at the time of shipment from the factory.

● Settings mode 2

<Operating procedure>

- (1) Press and hold the button, button, and button simultaneously for 4 seconds or longer.
- (2) Use the temperature setting and buttons to change the item code. The item codes and setting data are shown in the table below.
- (3) Use the timer time and buttons to change the setting data. To confirm the changed setting data, press the button. (At this time, "Setting" stops blinking and remains lit.)
- (4) During this mode, "Setting" is displayed, blinking. The display shows the set outdoor unit address "System XX-YY" (System XX = System address, YY = Address at outdoor unit sub-bus), item code number (DN value in the table below), and the setting data (6 digits). (The setting data is displayed in 6 digits. The display changes between the first 3 digits (Fig. (A)) and the last 3 digits (Fig. (B)). When the first 3 digits are displayed, the top point of the colon is lit.)
- (5) To end the setting mode, press the button. The display returns to the normal display mode.

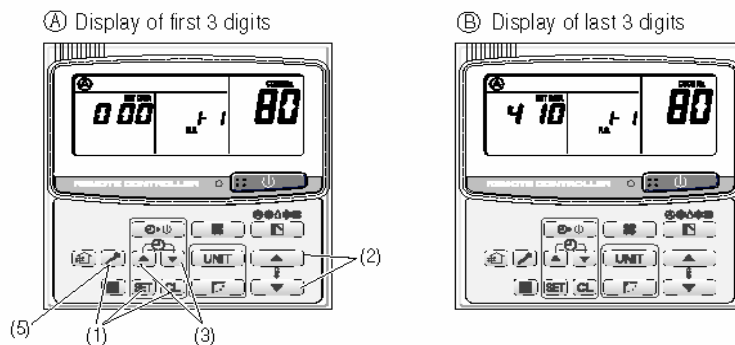
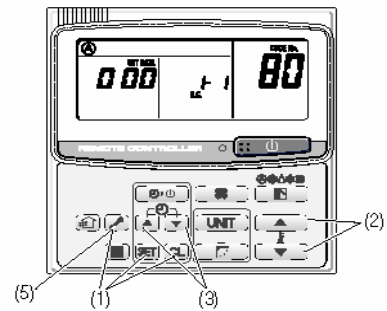

80: <Refrigerant type> (A) and (B) are displayed alternately. (Example shows 000 410 (R410A).)

List of Item Codes

Item code	Parameter	
80	Refrigerant type	407 = R407C 22 = R22 410 = R410A
81	Outdoor unit capacity*	0 = Disabled 22 25 28 32 36 40 45 50 56 63 71 80 90 100 112 125 140 160 180 200 224 250 280 340 355 400 450 500 560 600 630 670 710 800 840
82	Control system schedule	
83	Control system schedule	
84	3-phase or single-phase	0 = 3-phase 1 = single-phase
85	Power frequency	0 = Disabled 1 = 50 Hz
86	Control system schedule	
87	Control system schedule	
88	Control system schedule	
89	Control system schedule	
8A	Control system schedule	
8b	Control system schedule	
8E	Control system schedule	

(\*) Figures represent the capacity data for each model.



R.D. 28 Reyrieux BP 131 - 01601 Trévoux CEDEX France  
Tél. 04.74.00.92.92 - Fax 04.74.00.42.00  
R.C.S. Bourg-en-Bresse B 759 200 728