



CHGV

AIR COOLED WATER CHILLER WITH HYDRAULIC EQUIPMENT

AIR / WATER

21 to 39 kW



CHGV 22

CHGV 25

CHGV 32

CHGV 40

PHRV heat pump model also available

MARKING

This product marked  conforms to the essential requirements of the Directives:

- Low voltage no 2006/95/EC.
- Electromagnetic Compatibility no. 89/336 EEC, modified 92/31 EEC and 93/68 EEC.
- Pressure Equipment Directive No. 97/23/EC.



CONTENTS

1 - Application - Use	2
2 - Presentation	3
3 - Technical characteristics	4
4 - Physical characteristics	5
5 - Description	6
6 - Cooling performances	7
7 - Corrections to be made when using anti-freeze	8
8 - Curves of available pressures	8
9 - Sound levels	8
10 - Accessories	8
11 - "ECH" electronic control	10
12 - Installation information	10

APPLIANCES FILLED WITH R 407 C

R 407 C

- Fluid R 407 C, as opposed to R22, is not a pure fluid but a blend composed of:
 - 23% R 32 + 25% R 125 + 52% R 134 A.
- The compressors approved for operation with this fluid are filled beforehand with polyalcohol oil.
Contrary to mineral oil, it is very hygroscopic: it absorbs the humidity of the ambient air very quickly. This can modify its lubricant properties and lead in time to the destruction of the compressor.

MAINTENANCE INSTRUCTIONS

- 1 - Never add oil to the appliance; the compressor is filled with polyalcohol oil, a special oil which cannot tolerate the presence of other oils.
- 2 - The instruments used for:
 - filling,
 - pressure measurements,
 - emptying under vacuum,
 - recovering the fluid,must be compatible and only used for the R 407 C fluid.
- 3 - The weight of the refrigerant contained in the storage bottle must be checked constantly. Do not use it from the moment the remaining weight is less than 10% of the total weight.

- 4 - In the case of a new charge:

- do not use the charging cylinder,
- use a balance and a dip pipe type R 407 C cylinder,
- charge the weight of R 407 C as per the value indicated on the unit's identification plate,
- **IMPORTANT:** see instruction 3 above.

- 5 - The charge **must** be undertaken in liquid phase.

- 6 - In case of leakage, do not complete the charge: recover the remaining refrigerant for recycling and perform a total charge.

Recovery, recycling or the destruction of the fluid must be done in compliance with the laws in force in the country concerned.

- 7 - If the refrigerant circuit is opened, you must:

- avoid the entry of air into the circuit as much as possible,
- replace the filter drier,
- perform the "vacuum operation" at a minimum level of **0.3 mbar (static)**.

- 8 - Do not release R 407 C fluid into the atmosphere. This fluid is a fluorinated greenhouse gases, covered by the Kyoto Protocol with a Global Warming Potential (GWP) = 1653 - (CE Directive 842 / 2006).

1 - APPLICATION - USE

- Air cooled type chilled water generator intended for climate control in buildings.
- Single package unit, factory assembled and tested.
- Designed for outdoor installation.
- Supplied fully charged with R 407 C refrigerant.
- Convenient hydraulic and electrical connections.
- Practical service access via removable panels.

2 - PRESENTATION

- **CHGV:** An air cooled chilled water generator with built-in hydraulic equipment.

	Refrigerant	Model
		1 refrigerant circuit
CHGV	R 407C	22 / 25 / 32 / 40

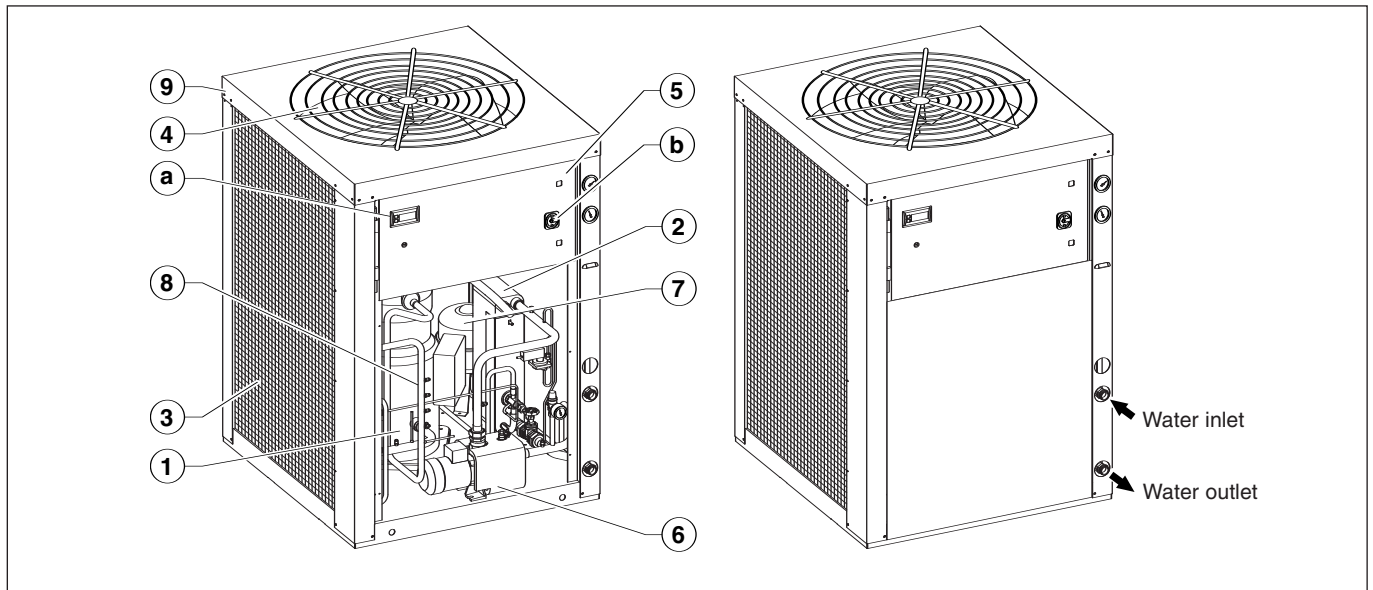

① SCROLL COMPRESSOR

- Mounted on vibration pads with sound insulation.

② WATER EXCHANGER

- Plate water exchanger with heat insulation.

③ AIR EXCHANGER

- Thin plate air exchanger with protective grille.

④ ELECTRIC FAN UNIT

- Electric fan unit with protective grille.

⑤ SWITCH BOX

- "ECH" electronic control **a**.
- Head pressure control.
- Main switch **b**.
- Phase-sequence tester.
- Power and control circuitry protected by magnetothermal circuit breakers.
- Complies with standard EN 60 204-1.
- Short circuit current 10 kA, as per IEC 947-2.

⑥ CIRCULATING PUMP

- Circulating pump with heat insulation.

⑦ EXPANSION TANK

⑧ REFRIGERATION CIRCUIT

- R407C load.
- Copper piping.
- Thermostatic regulator.
- Filter-dryer.
- HP and LP safety pressure switches.

⑨ CHASSIS - BODYWORK

- Galvanised sheet metal with light grey oven-baked polyester powder paint (RAL 7035).

3 - TECHNICAL CHARACTERISTICS

Model		CHGV 22	CHGV 25	CHGV 32	CHGV 40
Heating capacity	kW	20.70	23.80	31	39
Nominal power consumption *	kW	8.30	10.40	13.40	14.80
Effictuiveness heating *	(EER)	2.49	2.29	2.31	2.64
Total Max. power consumption **	kW	11.85	12.90	16.50	18.80
Total Max. current consumption **	A	22.5	24.3	31.6	35.8
Rated total input amperage	A	18	20.7	24.7	28.3
Starting current	A	145	145	150	190
Electrical supply cable section	mm²	6	6	6	10
Nominal water flow	m³/h	3.56	4.18	5.33	6.73
	L/s	0.99	1.16	1.48	1.87
Available pressure	kPa	210	170	200	135

(*) Gross value without hydraulic pump.

(**) In the operating range.

- **Power supply:**

400V (±10%) / 3 Ph + Neutral + Earth / 50Hz

- **Nominal operating conditions:**

- water inlet temperature : + 12°C
- water outlet temperature : + 7°C
- outdoor dry bulb temperature (dry) : + 35°C

- **Operating limits (pure water):**

- temperature of inlet air to condenser : - 10°C to + 45°C
- water outlet temperature : + 4°C to + 20°C



- **Water system pressure:** 1.5 to 3 bar.



Consult us for any special climatic conditions departing significantly from the nominal conditions.

4 - PHYSICAL CHARACTERISTICS

Dimensions (in mm) are given for standard units without options.

General tolerance ± 10 mm.

-  Condenser air discharge
-  Condenser air suction
- a** Chilled water inlet connection
- b** Chilled water outlet connection
- c** HP and LP hose entry

-  Electrical connections
-  Location of the 4 anti-vibration pads (accessory) (100 x 100 x 25 mm) under girders
- G** Centre of gravity (in the centre of the unit)

4.1 - CHGV

- Clearances to be respected for unit operation and maintenance.
- No obstacle less than 3 m above the unit.

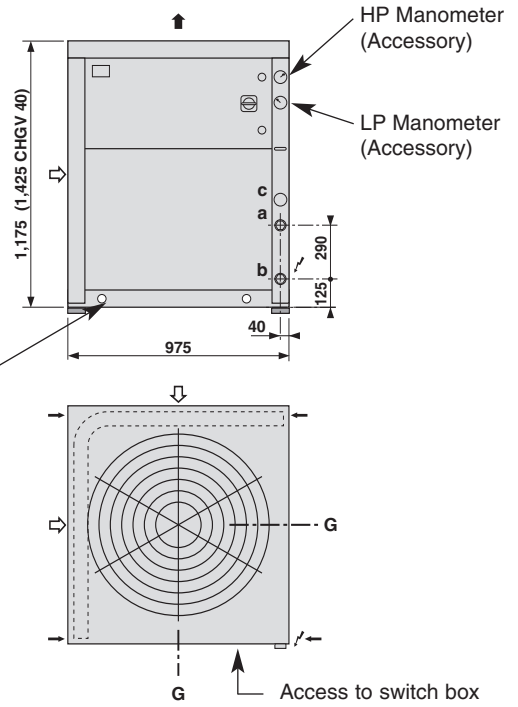
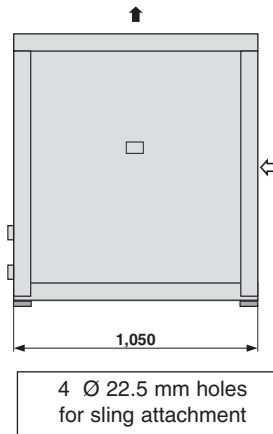
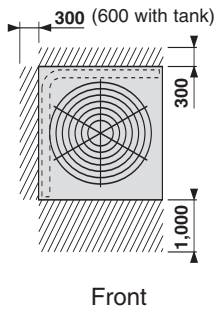

CHGV	Net weight		Packed weight	
	22	25	32	40
	292 kg	295 kg	317 kg	353 kg
	312 kg	315 kg	337 kg	373 kg

Overall packed dimensions	
Length	1,035 mm
Depth	1,135 mm
Height	1,370 mm
	CHGV 40

4.2 - 150-LITRE BUFFER TANK (Accessory)

- Side spacing is to be respected for maintenance purposes.

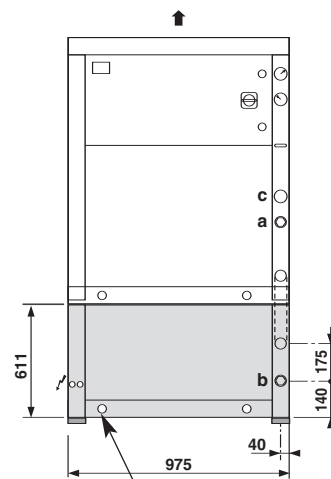
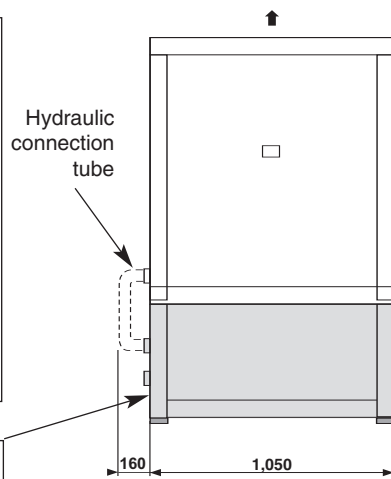
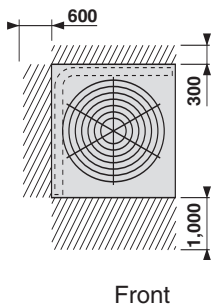

Tank without heating	Net weight		Packed weight	
	112 kg	126 kg	Length	Overall packed dimensions
			1,020 mm	
			Depth	1,110 mm
			Height	796 mm

4 Ø 22.5 mm holes for passing slings for handling the tank only

5 - DESCRIPTION

Model	CHGV 22	CHGV 25	CHGV 32	CHGV 40
Cooling circuit (number) with HP and LP pressure switches	1	1	1	1
R 407 C refrigerant charge kg	6.5	7.3	8	12.5
Hermetic SCROLL compressor with soundproofing and internal thermal protection	●	●	●	●
Number	1	1	1	1
Power supply 400V / 3 / 50Hz	●	●	●	●
Nominal current per compressor A	14.3	17	20.8	23.8
Nominal power consumed by the compressor kW	7.70	9.90	12.50	14.70
Helicoidal electric fan , direct coupling, with internal thermal protector	●	●	●	●
Number	1	1	1	1
Air flow m³/h	9,800	9,800	11,000	11,000
Diameter mm	760	760	760	760
Max. rotation speed (motor) rpm	620	620	660	660
230V / 1 / 50Hz power supply with speed control for condensation pressure control	●	●	●	●
Nominal current per motor (single-phase 230 VAC) A	3.5	3.5	3.9	3.9
Power consumption per motor kW	0.75	0.75	0.85	0.85
Air exchanger with protective grille, copper tubes, aluminium fins	●	●	●	●
Number	1	1	1	1
Water exchanger with stainless steel brazed plates AISI 316 L with thermal insulation	●	●	●	●
Number	1	1	1	1
Water capacity liters	1.7	2	2.5	2.9
Hydraulic circuit				
Male 1"1/4 coupling (33x42)	●	●	●	●
Minimum installation water volume * liters	70	70	95	120
Maximum installation water volume ** liters	300	300	300	300
Expansion tank (1.5 bar)	●	●	●	●
Tank capacity liters	8	8	8	8
Safety valve (3 bar) with pressure gauge	●	●	●	●
Differential water output pressure switch	●	●	●	●
Output control valve	●	●	●	●
Fill valve (ø 1/4" female)	●	●	●	●
Water filter supplied (not installed)	●	●	●	●
Circulating pump	●	●	●	●
Maximum power consumption (pump only) kW	0.77	0.77	1.06	1.06
Maximum current A	1.4	1.4	1.9	1.9
Power supply 400V / 3 / 50Hz	●	●	●	●
General electrical power supply 400V / 3N + Earth / 50Hz	●	●	●	●
Equipment protection index				
Electrical equipment	IP 24	IP 24	IP 24	IP 24
Mechanical risks	B	B	B	B

(*) If the water volume of the system is below the minimum, a buffer tank must be installed.

(**) If the water volume of the system is above the maximum, an additional expansion tank is required.

6 - COOLING PERFORMANCES

COOLING CAPACITY

TOTAL INPUT POWER

CHGV 22

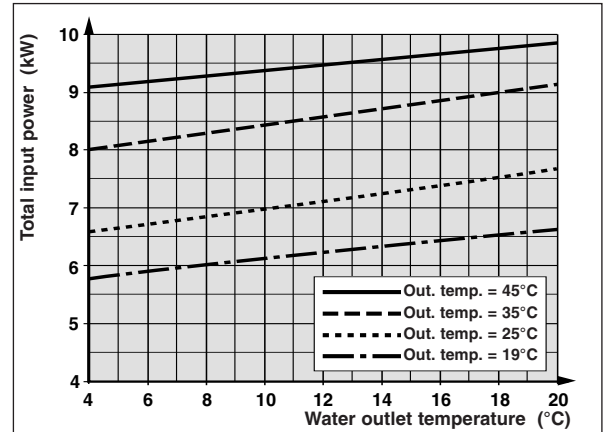
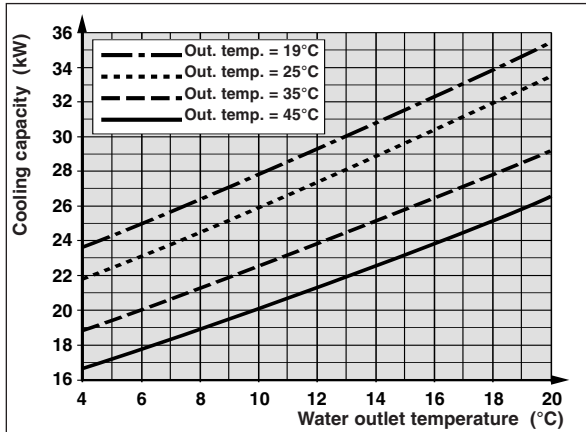

CHGV 25

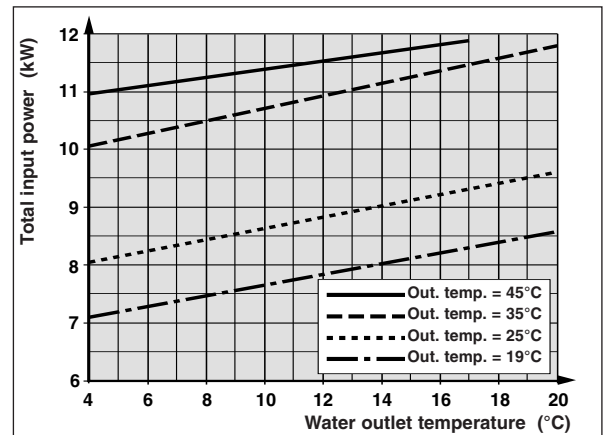
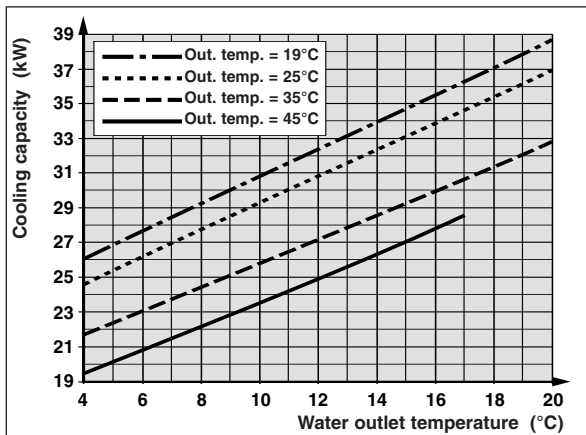

CHGV 32

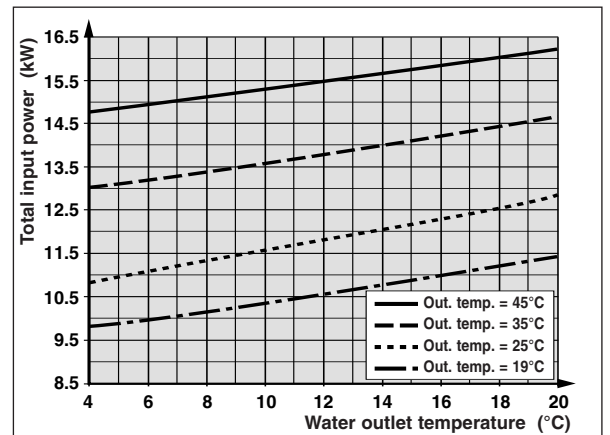
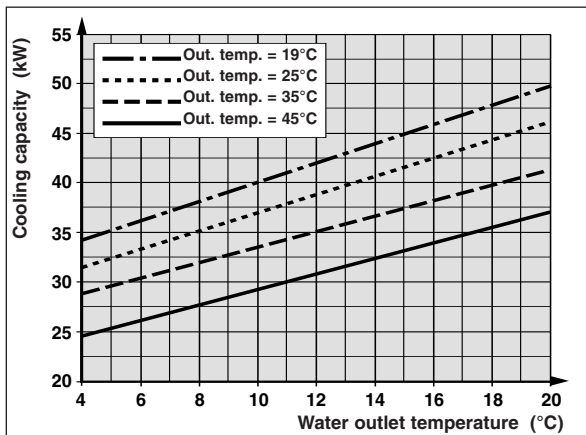

CHGV 40

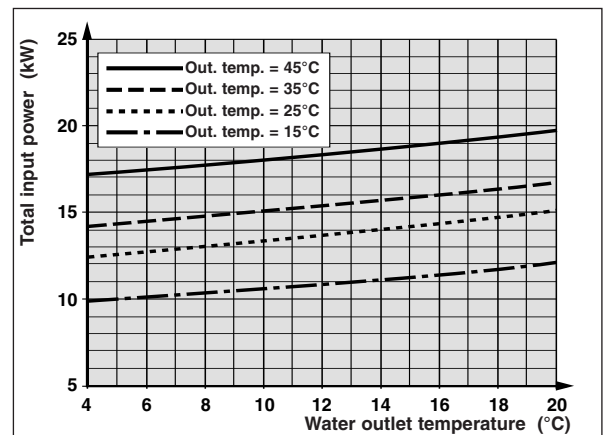
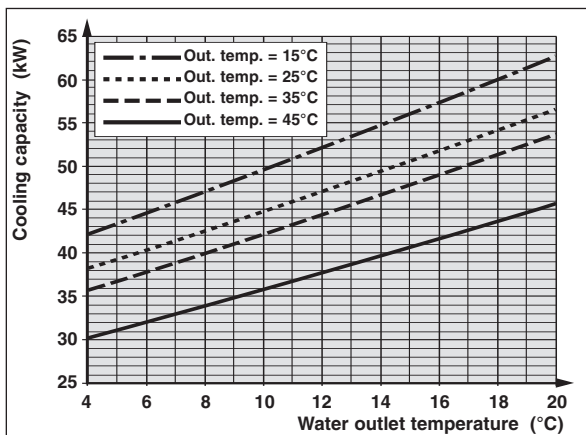

ΔT (water) between 4 and 6°K.

7 - CORRECTIONS TO BE MADE WHEN USING ANTI-FREEZE

- **IMPORTANT:**

Use monopropylene glycol; a minimum rate of 15% to 20% is needed to avoid any risk of corrosion.

PRINCIPLE OF USING THE CURVES

A - Choose the percentage of glycol according to the minimum temperature to protect the hydraulic circuit against frost.

B - Example:

Protection at an external temperature of -15°C, which gives 30% monopropylene glycol (freezing points curve).

The loss of capacity is given on the "Reduction of cooling capacity" curve (0.94).

The new flow is given by the coefficient on the water flow curve (1.113).

Likewise, to determine the new pressure drop coefficient in relation to the nominal flow, read the pressure drop curve (1.19).

Valid curves for setting temperature at the water inlet.

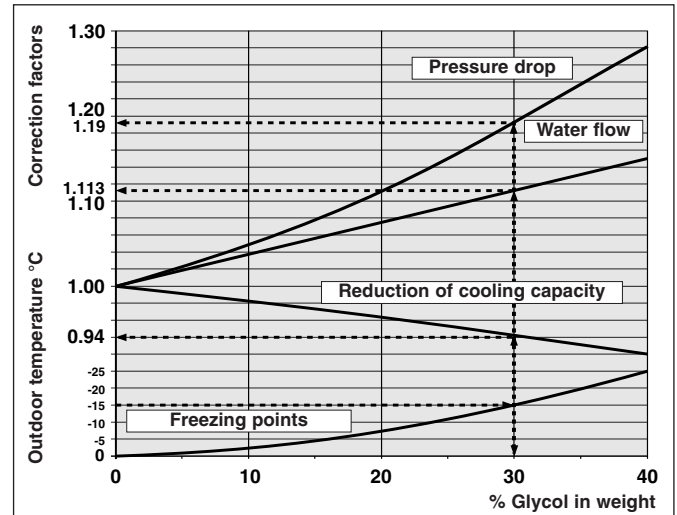

8 - AVAILABLE PRESSURE CURVES ON THE HYDRAULIC SYSTEM

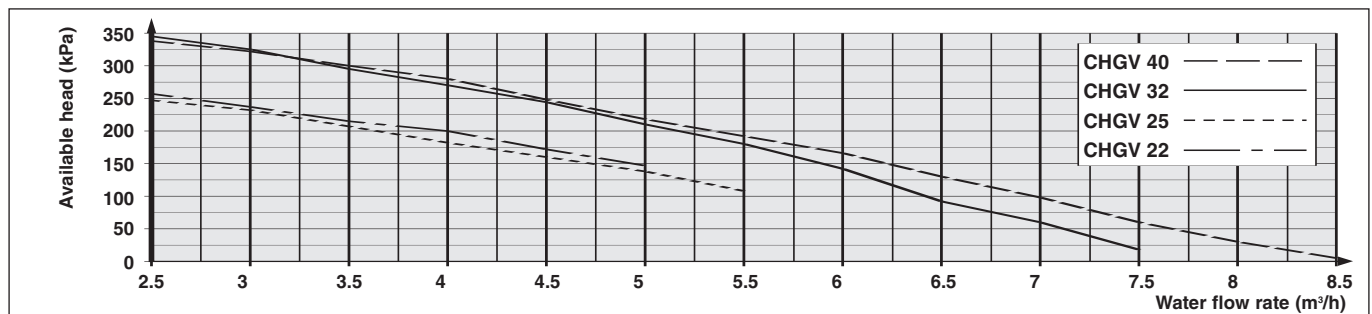

• Values at apparatus outlet without tank. (See § 10.5 for tank pressure losses).

9 - SOUND LEVELS

CHGV	Power level (dBA)	Sound-pressure level (dBA)
22	79	51
25	78	50
32	80	52
40	82	54

- **Nominal operating conditions:**

- Ambient temperature: 35°C.

- **Sound-pressure level:**

- Unit installed outdoors (free field) on a reflective surface.

- Measurement carried out at a distance of 10 m.

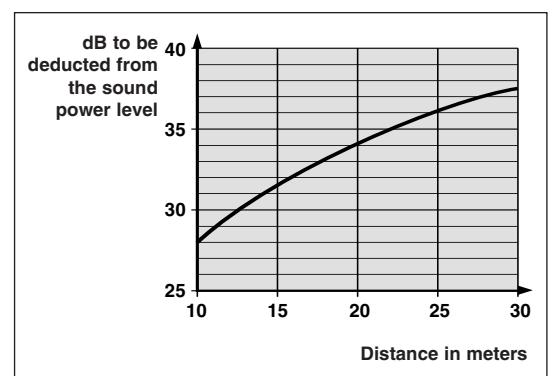

10 - ACCESSORIES

10.1 - ANTI-VIBRATION KIT

- Kit includes:

- 1 set of 4 anti-vibration plates, thickness 25 mm - code **70600035**.
- 1 set of 2 flexible hoses: length 1 m, Ø 1" 1/4 - code **70600027**.

10.2 - HP AND LP PRESSURE GAUGES

- Code **70970007**.
- The accessory includes 1 set of 2 pressure gauges.
- These elements, mounted on the vertical members of the unit's front face, display the high and low pressure values for the refrigeration circuit.

10.3 - REMOTE CONTROL

- Code **70250055**.
- Enables reporting of the controller's display keypad functions up to a distance of 100 meters.



10.4 - SERIAL COMMUNICATIONS INTERFACE RS 485 (MODBUS Protocol)

- Code **70250056**.
- Interface module installed inside the unit's electrical box.
- MODBUS protocol. Please consult us for details concerning the protocol and addressing of data.

10.5 - 150-LITRE BUFFER TANK

- Code **70600110**: model without supplementary heating with 800 W anti-freeze resistance (single-phase 230 VAC),
 - Designed to be installed either underneath the unit, or separately.
- For installation underneath the unit, the tank is supplied with mounting brackets and an insulated tube for connection between the unit's water outlet and the tank's water inlet.

Composition:

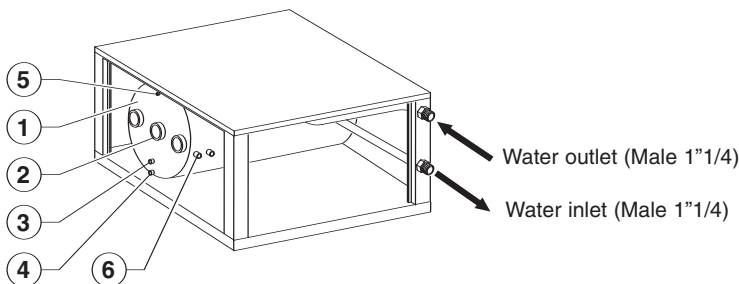

Mark		70600110 without heating
1	Sheetmetal buffer tank - polyurethane insulation	●
2	800 W anti-freeze resistance	●
3	Fill valve	●
4	Drain valve	●
5	Purge	●
6	Safety valve (5 bar)	●
	Galvanized steel chassis, painted RAL 7035	●

Anti-freeze resistance:

- Immersion heater mounted on the tank.
- Power: 800 W, single-phase 230 VAC.
- With limiting thermostat.
- **The power supply and heating element control are to be done separately at the time of installation (not supplied).**

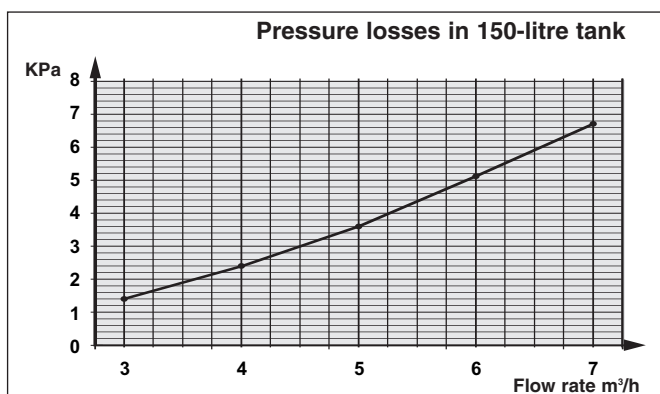

11 - "ECH" ELECTRONIC CONTROL

- Microprocessor control module, including:
 - chilled water temperature control (water inlet),
 - control of operating parameters,
 - self-adapting algorithm for water volume reduction,
 - circulating pump control (frost protection and anti-sticking function),
 - dynamic setpoints are possible according to the outside temperature (to be activated at the time of installation by means of special parameterization).
 - anti-short cycle system,
 - hour counter compressor and circulating pump,
 - alarm management,
 - anti-freeze security (temperature probe at water exchanger outlet),
 - digital display of:
 - . water temperature,
 - . set-point,
 - . alarm code (HP, LP, water output, probes, anti-freeze...).
 - remote alarm reporting is possible via a potential-free contact,
 - remote control with display unit (accessory),
 - serial communications port (RS 485 interface, accessory) - MODBUS Protocol.

12 - INSTALLATION INFORMATION

- See details in the installation manual.

12.1 - INSTALLATION

- Protection index of the unit:
 - IP 24 : for the electrical equipment,
 - (IPXXB : for the mechanical hazards).
- Before installation, verify the following points:
 - the unit must be installed outside in an appropriate location and in compliance with environmental requirements (sound level, integration, etc...),
 - the water chiller's installation location must be perfectly level and strong enough to support the weight of the unit and must have adequate inundation protection,
 - sufficient space around the unit should be provided in order to facilitate servicing and maintenance operations,
 - air suction to the coil and fan discharge must not be obstructed,
 - install the unit above the region's average snowfall level,
 - vibrations and noise must not be transmitted to adjacent buildings,
 - install the machine on anti-vibration pads and fit hoses on piping elements, as required,
 - if necessary, consult an acoustics specialist concerning the unit's optimum location,
 - 4 holes Ø 22.5 enable to place hoisting hooks and lift the unit.

12.2 - ELECTRICAL CONNECTIONS

- All required information is indicated on the electrical diagram provided with the unit and in the installation manual.
- Connections are to be made in compliance with the standard code of practice and as per the standards in force at the site of installation.

12.3 - HYDRAULIC CONNECTIONS

- The hydraulic connections are to be made in compliance with the standard code of practice.
- **IMPERATIVE:** Install the filter supplied on the water inlet of the unit.

12.4 - STARTING - MAINTENANCE

- Refer to the installation guide and the maintenance manual.
- **IMPORTANT:**
 - The unit's electronic control features a frost protection device that automatically starts the water circulating pump depending on the outside temperature (adjustable threshold), even if the unit is turned off.
 - In the event the unit may be taken out of service or in the case of a high risk of freezing:
 - either drain the installation,
 - or add glycol to the circuit.
 - Tank anti-freeze resistance:
its electrical power supply and control must be separate from those of the unit.

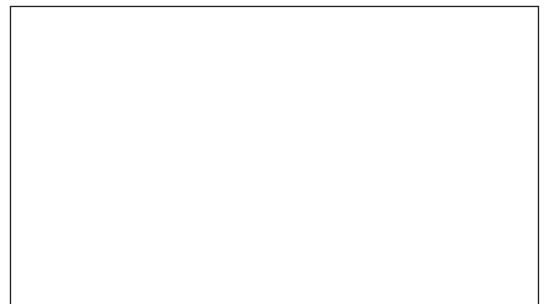

Due to our policy of continuous development, our products are liable to modification without notice.

Technibel

R.D. 28 Reyrieux BP 131 01601 Trévoux CEDEX France
Phone 33 4 74 00 92 92 - Fax 33 4 74 00 42 00
R.C.S. Bourg-en-Bresse B 759 200 728