



Ilmavirtojen mittaus- ja säätölaite

SAM

- Luotettava mittaus
- Tarkka säätö
- Kanava jää täysin vapaaksi, kun kuristinlevy irrotetaan
- Helppo puhdistaa, kuristinlevyn voi pestä
- Suuttimen muotoilun ansiosta äänitaso on alhainen

Mitat

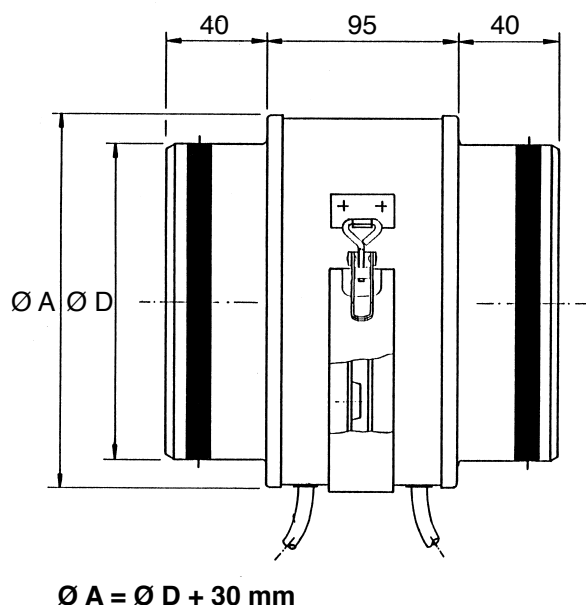

Tuotemerkintä

Säätölaite SAM-100
1

1 = koko $\text{Ø} 100 - 500$

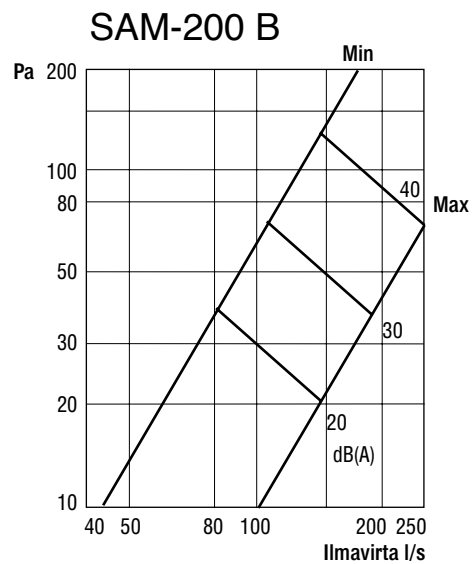
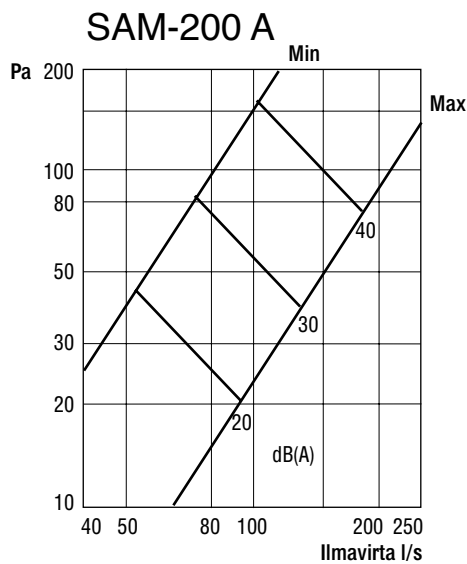
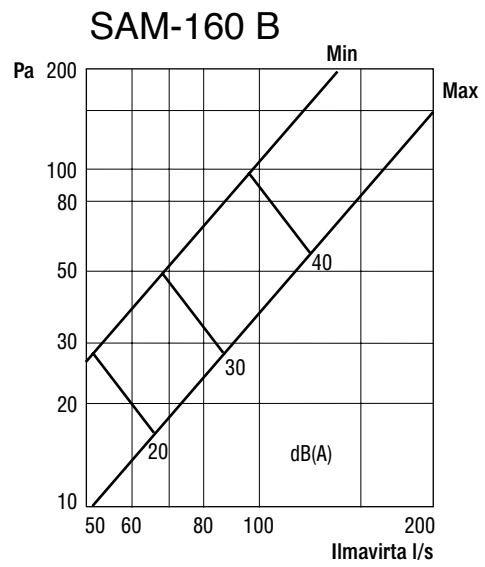
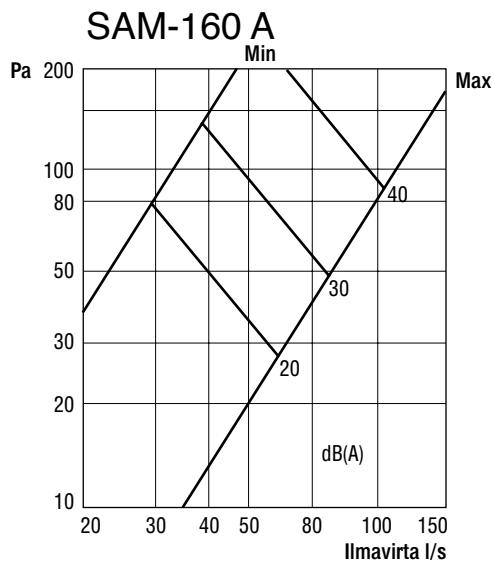
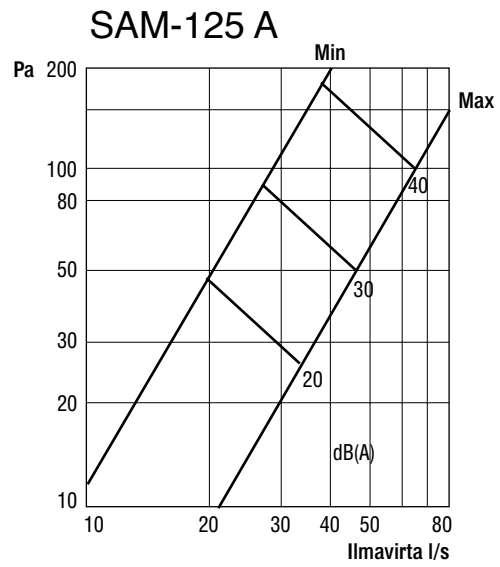
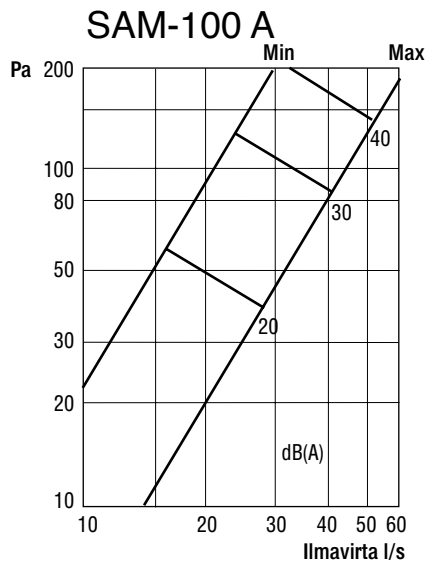

SAM-250 A

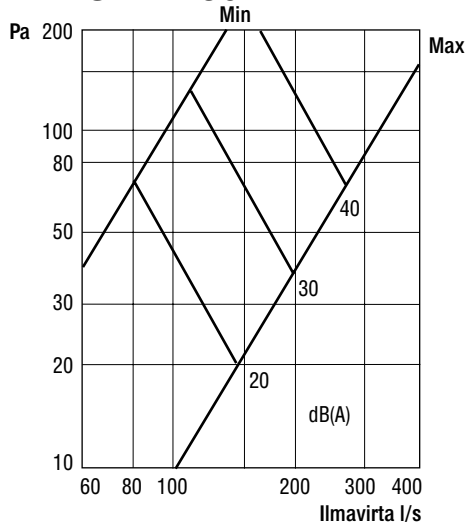

SAM-250 B

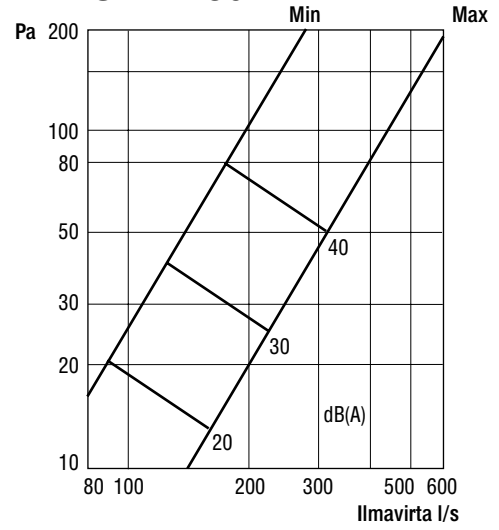

SAM-315 A

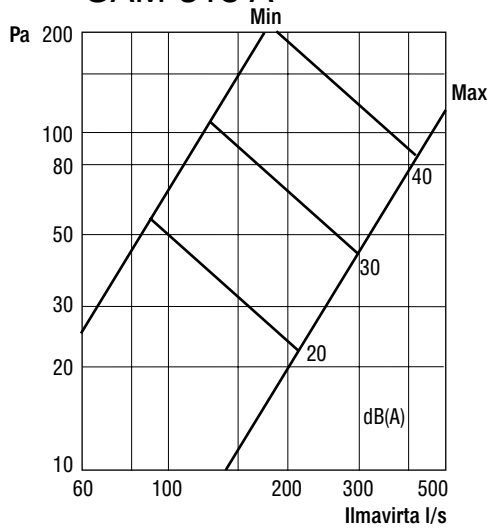

SAM-315 B

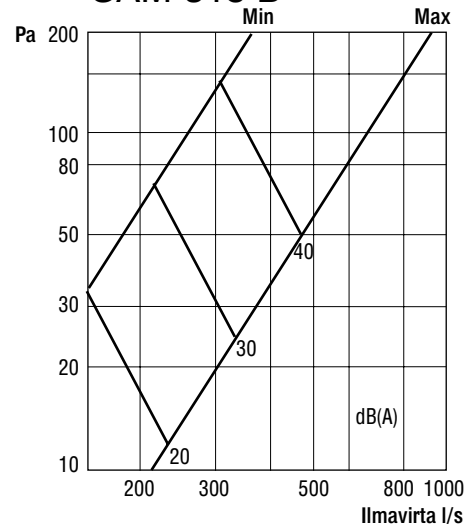

SAM-400 A

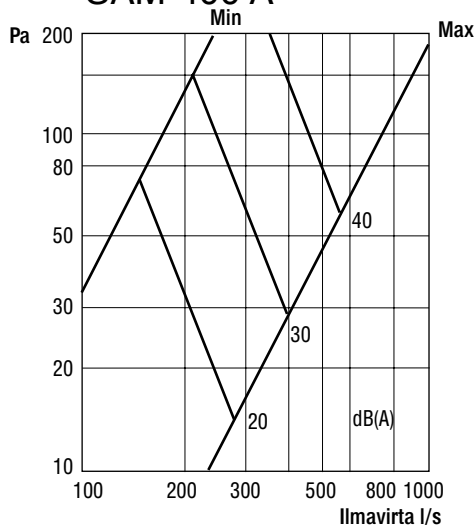

SAM-400 B

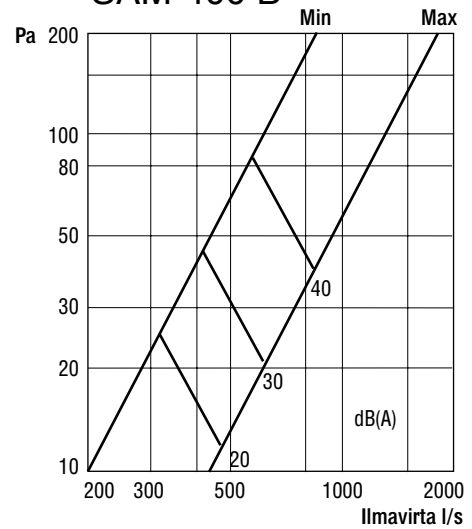

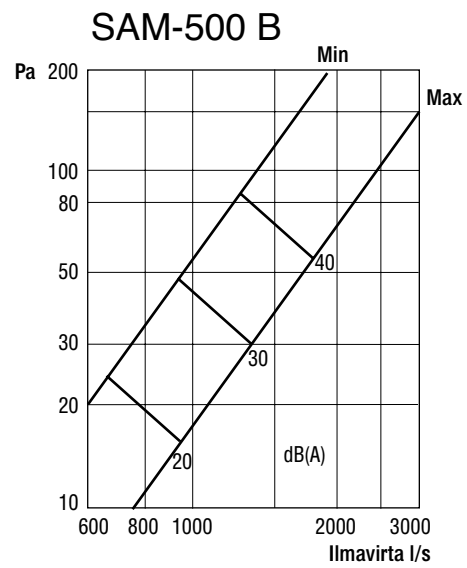
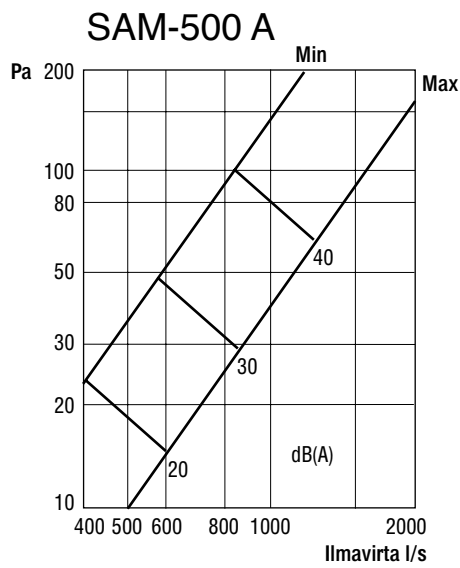

Suojaetäisyys

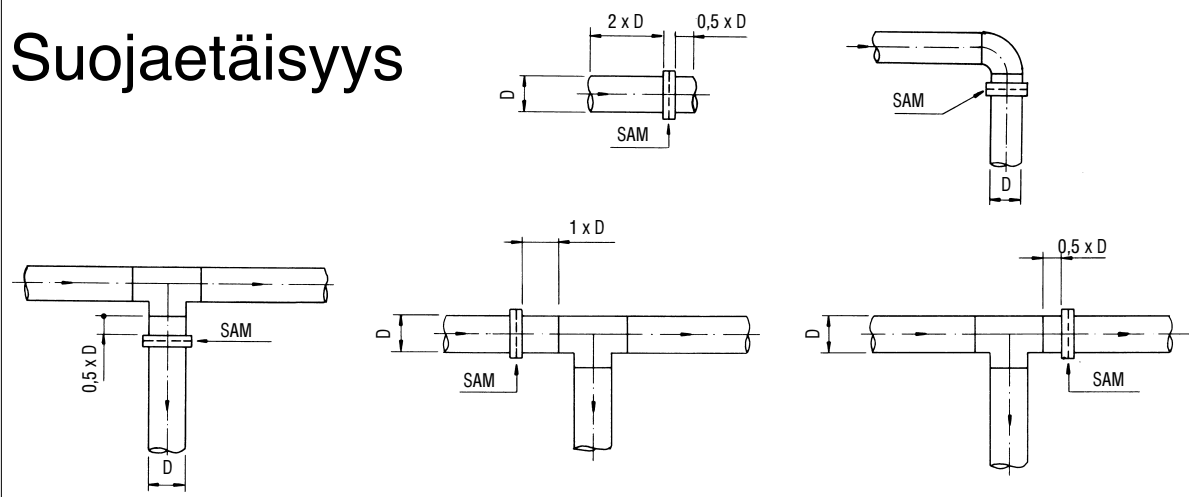

Säätö

Säätöohje nro 65

- Mitataan paine-ero
- Kun ilmavirta ja paine-ero on tiedossa, tarkistetaan säätöasento mittaushjeesta
- Irrotetaan kuristinlevy ja tulpataan tarvittava määrä suuttimia

