

# MCM-140

## Wireless Remote Commander



# Visonic

## User's Guide

### 1. INTRODUCTION

The MCM-140 is a wireless remote control unit for the PowerMax system. It enables the user to arm/disarm the alarm system, to initiate emergency/fire/panic alarms, to perform one of the AUX (auxiliary) functions (see Note 3 in Section 6) and to turn lighting devices on and off. The keypad includes an RF transmitter that sends out a differently coded RF signal for each command.

The main features of the MCM-140 are:

- Automatic reporting of low battery voltage.
- Visual indications by red/green/amber LED.
- Keypad back lighting (selectable)
- Various audible signals sounded by the buzzer in response to specific actions.
- Automatic supervision messages at 60 minute intervals or according to the local standards.
- Long-life 3 VDC lithium battery.
- Wall mounting option.
- Friendly programming.

The red LED lights during transmission. The amber LED lights during the programming process (and during transmission if battery voltage is low). The green LED lights upon each keystroke.

#### LED Indications

Description	Symbol
Blinks at a fast rate	-----
Blinks at a slow rate	- - - - -
Lights steadily (during transmission)	_____

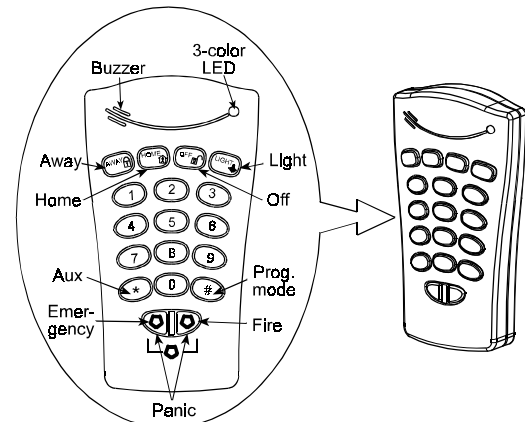

Figure 1 - External View

#### Keypad Buzzer Sound

Description	Symbol
Short single beep, upon pressing a key	
2 short beeps, in the programming process (par. 4.3 & 4.5)	
Success (victory) melody	
Failure beep	

### 2. SPECIFICATIONS

**Transmitted ID Type:** PowerCode and CodeSecure

**PowerCode** - Used for Lights 1-7, Light 8 (PGM controlled), Fire and Emergency functions

**CodeSecure** - Used for Home arming, Away arming, Disarming, Aux and Panic functions

**Operating Frequency (MHz):** 315, 433.9 and 868.95

**Battery:** 3 VDC, Lithium battery, CR123A

**Back light illumination:** Selectable on/off

**Dimensions (HxWxD):** 127 x 70 x 24 mm (5 x 2-3/4 x 31/32 in.)

**Operating Temperatures:** 0°-49°C (32°-120°F)

**Compliance with Standards:** FCC part 15, IC:1467102181.

The term "IC" before the certification/registration number only signifies that the Industry Canada technical specifications were met.

### 3. MOUNTING AND BATTERY REPLACEMENT

Drill 2 holes in mounting surface, insert wall anchors and fasten the bracket with 2 screws

Slide the keypad into the bracket

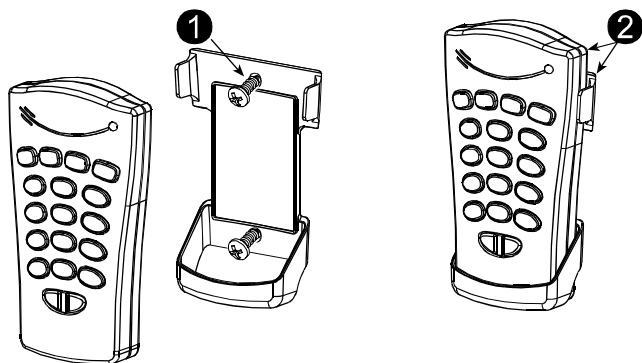

Figure 2 - Mounting

Replace battery (verify proper polarity) and close cover

Slide out the cover

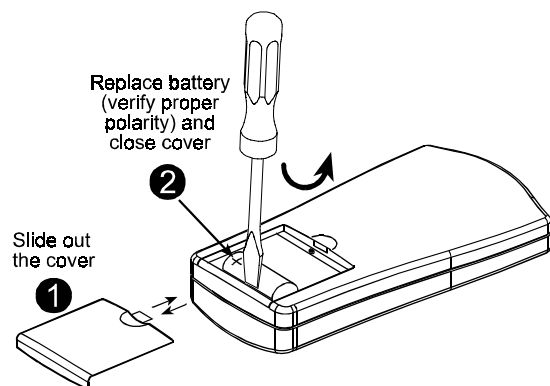

Figure 3 - Battery Replacement

## 4. PROGRAMMING

### 4.1 Programming Scope



The following programming actions are possible:

- Setting the master user (user #1) code.
- Setting other user codes (users #2-8).
- Allowing/forbidding quick arming of the keypad.
- Muting/reactivating the keypad's buzzer.
- Controlling the keypad's back-lighting.
- Enabling/disabling the supervision/low battery reporting from the MCM-140.

### 4.2 Entering the Programming Mode

The programming mode is accessible with the master code only (1 1 1 by default). The "#" key is used to enter and also to exit the programming mode.



#### Entering the Programming Mode

Action	LED indication	Buzzer response
#	Green LED blinks slowly until the master code is keyed *	
[master code] (1111 by default)	Amber LED blinks slowly during programming *	 (success melody)

\* Upon entering the programming mode, the success melody is heard and the amber LED starts blinking. Blinking will stop once you exit from this mode (by pressing "#" again) or upon time out during which no key is pressed. 2 short beeps are heard when the LED stops blinking.

### 4.3 Changing Master/User Codes

To change the MCM-140 master and user codes, enter the programming mode (Par. 4.2) and proceed as follows:

Action	LED indication	Buzzer response
[1-8] <sup>1</sup>	Amber LED blinks	
[new code] <sup>2</sup>	Amber LED blinks quickly - (blinks slowly after success)	 (success melody)

#### Notes

1. Enter user No. (1-8). User No. 1 is defined as the master user.
2. Master/user codes consist of 4-digits. Code "0000" is not valid. It can be used to erase the currently programmed code (when this action is performed, success melody is heard).
3. PowerMax user codes and MCM-140 user codes are different codes.

### 4.4 Restoring the Default Master Code

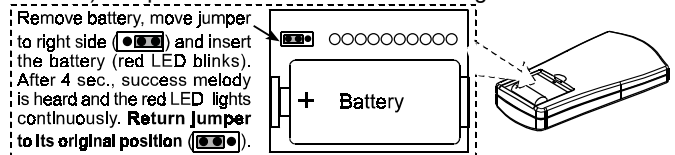

If the master code is forgotten, it is possible to recall the factory default master code "1111". To ensure that this possibility is not misused by unauthorized people, a panic alarm is automatically transmitted to the PowerMax system when such an action is performed.

To recall the default master code and prevent a panic alarm, set PowerMax to User Settings mode (see PowerMax Prog. Guide, Par. 1.2) and proceed as shown in the following illustration:



### 4.5 Special Programming Options

Enter the programming mode (Par. 4.2) and proceed as follows:

Desired function	Press	and then press:
Quick arming	9 → 1	 <b>AWAY</b> to enable (amber LED lights)  <b>OFF</b> to disable (amber LED blinks). In both cases, the buzzer sounds twice, to indicate success.
Buzzer control	9 → 2	
Back lighting	9 → 3	
Supervision / low battery reporting (only by using Fire button)	9 → 4	

**Notes:** The supervision message will be sent once an hour. When there is Low Bat condition, trouble message will be displayed in the zone that was selected for the FIRE key.

## 5. ENROLLING THE MCM-140 TO THE POWERMAX

### 5.1 Enrolling Arming, Disarming, Aux and Panic Functions

To enroll the MCM-140 keyfob functions (Home/Away arming, Disarming, Aux and Panic functions), proceed as follows:

A. Enter PowerMax installer menu (see PowerMax Programming Guide, document DE5450P, par. 1.2).

The PowerMax display will be "1. NEW INSTL CODE".

B. Click <NEXT>. The enrolling mode will be selected and the PowerMax display will show:

2 . ENROLLING

C. Click <OK>.

The PowerMax display will change to:

ENROLL WL DEVICE

D. Click <NEXT>. The PowerMax display will read:

ENROLL KEYFOB

E. Click <OK>. The PowerMax display will read:

Key fob No : \_

F. Press the key on the PowerMax keypad that corresponds with the location (1-4) that you wish to enroll in (assuming that the PowerMax memory locations No. 1, 2, 3 and 4 are free - no keyfob has yet been enrolled to them).

Note: It is possible to enroll into all 8 locations (1-8), but in such a case all the disarming actions that are performed with the MCM-140 (after performing Latchkey arming) will be considered as Latchkey disarming, even if users 1-4 perform the disarming. If you don't use the Latchkey function, or if you disable the Latchkey arming (see programming guide, par. 4.20) you can use all the 8 location.

If, for example, you have pressed the "1" key of the PowerMax keypad, the PowerMax display will change to:

Key fob No : 1

The clear space at the far right tells you that the memory location is free.

G. Click <OK>. The PowerMax display will prompt you to initiate a transmission from the MCM-140:

TRANSMIT NOW

H. Initiate a transmission from the MCM-140 by pressing the "\*" button for 2 sec. approximately. As a result, the "Happy Tune" (- - -) will sound and the PowerMax display will change to:

Key fob No : 1 ■

A dark box will appear at the far right, indicating that the chosen function has been enrolled.

**Note:** If the same function is already enrolled elsewhere, the "Happy Tune" will sound twice in succession.

## 5.2 Enrolling Lights, Fire, and Emergency Functions

The following MCM-140 PowerCode control functions can be enrolled:

- Lights No. 1-7
- PGM output (activated by  [8])
- Fire
- Emergency

To enroll these functions, proceed as follows:

A. Enter PowerMax installer menu (see PowerMax Programming Guide, document DE5450P, par. 1.2). The PowerMax display will be "1. NEW INSTL CODE".

B. Click <NEXT>. The enrolling mode will be selected and the PowerMax display will show:

2 . ENROLLING

C. Click <OK>. The PowerMax display will change to:

ENROLL WL DEVICE

D. Click <OK> again. The PowerMax display will read:

Zone No : █ \_

E. From the PowerMax keypad, enter the number of the zone to which you wish to enroll your first electrical device. For instance, if you enter <2> ⇒ <3>, the PowerMax display will change to:

Zone No : 23 █

The clear space at the far right tells you that the zone is free - no wireless device has been enrolled to it as yet.

F. Click <OK>. The PowerMax display will prompt you to initiate a transmission from the chosen wireless device:

TRANSMIT NOW

G. Initiate transmission from the MCM-140 by pressing the LIGHT key followed by pressing "1" (for electrical device #1).

H. In response to the transmitted signal, the "Happy Tune" (---) will sound and the PowerMax display changes to:

Zone No : 23 █

A dark box will appear at the far right, indicating that the chosen device has been enrolled to Zone No. 23.

I. On the PowerMax, press NEXT button.

J. Perform steps "E" to "H" for the other electrical devices (No. 2 to 8).

K. Perform steps "E" to "H" for the MCM-140 FIRE and EMERGENCY functions. When you are instructed to transmit, press the MCM-140 FIRE/EMERGENCY key for 2 seconds until the RED LED lights and "Happy Tune" (---) sounds.

### Notes













1. There is no need to teach the keypad PANIC function for the PowerMax - it will be automatically performed.
2. Define the zones that are enrolled for the 1-8 lights as non-alarm zones, to prevent an alarm display when a light is turned on.

## 5.3 Programing PGM/X-10 Devices as "On by Zones"

To enable activation of PGM/X-10 devices from the MCM-140, they must be programmed as "On by Zones". For the programming process, refer to the PowerMax programming guide, section 7 (Defining Output Parameters).

## 6. OPERATION

The following table describes how to activate the various functions.

Function	Actions
Arming HOME	 [user code] <sup>(1)</sup> <sup>(8)</sup>
Arming AWAY	 [user code] <sup>(8)</sup>
Disarming	 [user code]
Light (1-7) On/Off	 [1-7] <sup>(2)</sup>
PGM output	 [8]
AUX Function	 (≈ 2 sec.) <sup>(3)</sup>
Emergency alarm	 (≈ 2 sec.) <sup>(7)</sup>
Fire alarm	 (≈ 2 sec.) <sup>(7)</sup>
Panic alarm	 (≈ 2 sec.) <sup>(7)</sup>
Latchkey arming	 ...  <sup>(4)</sup>
Quick arm	 (≈ 2 sec.). (LED blinks, then lights RED during transmission)

### Notes

1. Eight user codes are possible (user code # 1 is the master user code). Factory default master code is "1111". Upon entering a valid code or a valid command, the success (victory) melody is heard and the red LED lights briefly (transmission indication).
2. Pressing  followed by the desired light number (1-7) turns on this light (success beeps are heard). Performing these actions again turns this light off and so on.

In order that the electrical device will be turned off when the light key is pressed the second time, the Toggle mode must be selected on the "PGM/X-10 Time" (refer to the PowerMax programming guide, par. 5.20).

3. The AUX function works just like the [\*] key in the keyfob. Pressing the Auxiliary Function key  (≈ 2 sec.) can initiate the STATUS action (system status announcement), the INSTANT action (entry delay cancellation) or the PGM action (activation of PGM output or X-10 units), depending on prior installer programming. For selecting the desired auxiliary function, refer to the PowerMax Programming manual, Para. 5.16 (AUX Button).
4. For LATCHKEY arming function, press the AWAY key, wait until the red LED extinguishes, then press the AWAY key again. The red LED lights and extinguishes again. From PowerMax version V1.16: Latchkey disarming (opening) can be done by user No. 8, by using code numbers 5-8 of the MCM-140.
5. Pressing a non-valid code combination (not master / user code) causes a long failure beep.
6. If a keying sequence is not completed within timeout, the desired function will not be executed.
7. Pressing the Emergency, Fire or Panic buttons, causes the red and green LEDs to blink alternately for 2 seconds to alert the user. The red LED lights during transmission.
8. If arming Home or arming AWAY command is used with an invalid user code, the command will not be performed. To enter the arming HOME/AWAY command again, you have 2 choices:
  - a. Wait until time out to expire and the green LED stops blinking. Then try again.
  - b. Press HOME/AWAY twice, then enter user code again.

## 7. COMPLIANCE WITH STANDARDS

This device complies with the essential requirements and provisions of Directive 1999/5/EC of the European Parliament and of the Council of 9 March 1999 on radio and telecommunications terminal equipment.

### Frequency Allocations for Wireless Devices in European Countries:

- 433.92 MHz has no restriction in any EU member state.
- 418 MHz is allowed in the UK only.
- 315 MHz is not allowed in any EU member state.
- 868.95 MHz (wide band) is allowed in all EU member states except for Belgium.

- 869.2625 MHz (narrow band) is not restricted in any EU member state.

The user is cautioned that changes or modifications to the unit, not expressly approved by Visonic Ltd., could void the user's FCC or other authority to operate the equipment.

The 315 MHz model of this device complies with Part 15 of the FCC Rules and RSS-210 of Industry and Science Canada. Operation is subject to these two conditions: (1) This device may not cause harmful interference, and (2) this device must accept any interference received, including interference that may cause undesirable operation.

### WARRANTY

Visonic Ltd. and/or its subsidiaries and its affiliates ("the Manufacturer") warrants its products hereinafter referred to as "the Product" or "Products" to be in conformance with its own plans and specifications and to be free of defects in materials and workmanship under normal use and service for a period of twelve months from the date of shipment by the Manufacturer. The Manufacturer's obligations shall be limited within the warranty period, at its option, to repair or replace the product or any part thereof. The Manufacturer shall not be responsible for dismantling and/or reinstallation charges. To exercise the warranty the product must be returned to the Manufacturer freight prepaid and insured.

**This warranty does not apply in the following cases:** improper installation, misuse, failure to follow installation and operating instructions, alteration, abuse, accident or tampering, and repair by anyone other than the Manufacturer.

This warranty is exclusive and expressly in lieu of all other warranties, obligations or liabilities, whether written, oral, express or implied, including any warranty of merchantability or fitness for a particular purpose, or otherwise. In no case shall the Manufacturer be liable to anyone for any consequential or incidental damages for breach of this warranty or any other warranties whatsoever, as aforesaid.

This warranty shall not be modified, varied or extended, and the Manufacturer does not authorize any person to act on its behalf in the modification, variation or extension of this warranty. This warranty shall apply to the Product only. All products, accessories or attachments of others used in conjunction with the Product, including batteries, shall be covered solely by their own warranty, if any. The Manufacturer shall not be liable for any damage or loss whatsoever, whether directly, indirectly, incidentally, consequentially or otherwise, caused by the malfunction of the Product due to products, accessories, or attachments of others, including batteries, used in conjunction with the Products.

The Manufacturer does not represent that its Product may not be compromised and/or circumvented, or that the Product will prevent any death, personal and/or bodily injury and/or damage to property resulting from burglary, robbery, fire or otherwise, or that the Product will in all cases provide adequate warning or protection. User understands that a property installed and maintained alarm may only reduce the risk of events such as burglary, robbery, and fire without warning, but it is not insurance or a guarantee that such will not occur or that there will be no death, personal damage and/or damage to property as a result.

**The Manufacturer shall have no liability for any death, personal and/or bodily injury and/or damage to property or other loss whether direct, indirect, incidental, consequential or otherwise, based on a claim that the Product failed to function.** However, if the Manufacturer is held liable, whether directly or indirectly, for any loss or damage arising under this limited warranty or otherwise, regardless of cause or origin, the Manufacturer's maximum liability shall not in any case exceed the purchase price of the Product, which shall be fixed as liquidated damages and not as a penalty, and shall be the complete and exclusive remedy against the Manufacturer.

**Warning:** The user should follow the installation and operation instructions and among other things test the Product and the whole system at least once a week. For various reasons, including, but not limited to, changes in environmental conditions, electric or electronic disruptions and tampering, the Product may not perform as expected. The user is advised to take all necessary precautions for his /her safety and the protection of his/her property.

6/91



VISONIC LTD. (ISRAEL): P.O.B 22020 TEL-AVIV 61220 ISRAEL. PHONE: (972-3) 645-6789, FAX: (972-3) 645-6788  
VISONIC INC. (U.S.A.): 10 NORTHWOOD DRIVE, BLOOMFIELD CT. 06002-1911. PHONE: (860) 243-0833, (800) 223-0020. FAX: (860) 242-8094  
VISONIC LTD. (UK): FRASER ROAD, PRIORY BUSINESS PARK, BEDFORD MK44 3WH. PHONE: (0870) 730-0800 FAX: (0870) 730-0801  
INTERNET: [www.visonic.com](http://www.visonic.com)

©VISONIC LTD. 2002 MCM-140 DE2460U (REV. 1, 6/02)

