



Description

The OptiLine Floor box system is an installation system for power, telephone and data links in office flooring.

OptiLine floor boxes are made of plastic material or stainless steel and include mounting frames for Altira, Fuga or Unica outlets, a trim frame and a lid.

The lid of plastic boxes can be decorated with floor material of 6 mm thickness, whereas that of steel boxes can take floor material of up to 15 mm thickness. Six mm thick lid infills of grey linoleum or stainless steel are available as accessories.

There are two sizes available of the floor box; 199x199 mm and 199x276 mm. The smaller size can be equipped with four single or two double outlets. The bigger one is available either for six single or three double outlets or for eight single or four double outlets.

The floor box system also includes floor access boxes, screeded floor boxes, and a number of accessories such as strain relief, partition wall, swivel fixing and lid infill.

Application

The OptiLine Floor box system is suitable for use in raised access floors, screeded floors and in-cavity floors.

Benefits

- Quick and easy installation
- Two sizes and 16 variants of floor outlet box
- Suits both 45x45 mm single and 45x90 mm double outlets
- High load capacity conforming to EN 50085-2-2
- Lids can be finished with most floor materials
- Choice of opening direction
- Height of mounting frames adjustable in steps of 5 mm
- Halogen-free

Technical and Material data

ABS	Density	1.04 g/cm ³
	Water absorption	0.95%
	Fire rating	UL 94 HB (1.6 mm)
	Colour	Grey
PA6	Density	1.13 g/cm ³
	Fire rating	UL94 V2 (3.2 mm)
	Colour	<ul style="list-style-type: none"> • Blue • Grey • Red
PA6 with 30% glass pellets	Density	1.36 g/cm ³
	Fire rating	UL 94 HB
	Colour	Grey
PBT with 30% glass-fibre	Density	1.52 g/cm ³
	Fire rating	UL 94 HB (1.5 mm)
	Colour	Grey
PC/ABS	Density	1.14 g/cm ³
	Water absorption	0.6%
	Fire rating	UL 94 HB (halogen-free)
	Colour	Anthracite grey
PC+ASA	Density	1.15 g/cm ³
	Water absorption	0.6%
	Fire rating	UL 94 HB
	Colour	White
PP	Density	0.91 g/cm
	Fire rating	UL 94 HB (1.5 mm)
	Colour	<ul style="list-style-type: none"> • Light grey • Yellow
Sheet steel	Specification	S 350 GD
	Density	7.8 g/cm ³
	Surface treatment	Zinc coated
Stainless steel	Specification:	X5CrNi 18-10
	Density:	7.8 g/cm ³
Degree of protection	IP20	
Standards	The products comply with the standards IEC 60670-23 and EN 50085-2-2	
	The products satisfy the provisions for CE marking according to the Low Voltage Directive 73/23/EEC and 93/68/EEC	
Temperature range	Operating temperature from -25°C to +60°C	

Exploded views

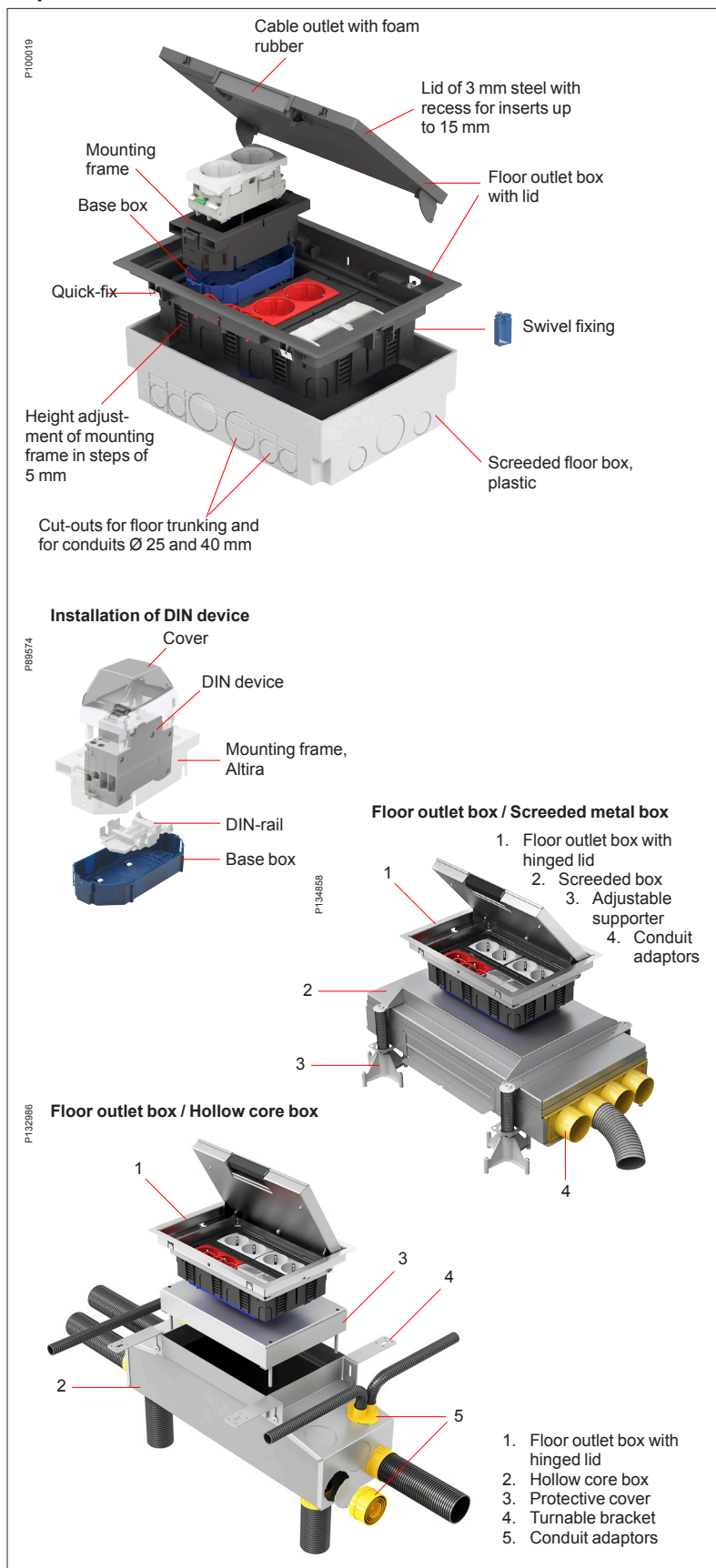

Mounting instructions

Mounting instructions are enclosed with the product.

Plastic boxes

Art.No. 0075254 / 20051187	Floor outlet box, 4 modules
Art.No. 0075255 / 20051188	Floor outlet box, 6 modules
Art.No. 0075256 / 20051193	Floor outlet box, 8 modules
Art.No. 0075257 / 20051189	Floor access box
Art.No. 0075274 / 20051190	Screeded floor box

Metal boxes

Art.No. 20075611	Floor outlet box, 4 modules
Art.No. 20075612	Floor outlet box, 6 modules
Art.No. 20075613	Floor outlet box, 8 modules
Art.No. 20063486	Screeded floor box
Art.No. 20075524	Hollow core box

Max. load according to EN 50085-2-2

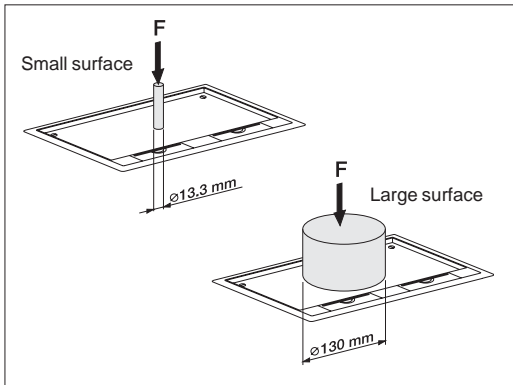

Hole dimensions

Floor box, 4 modules

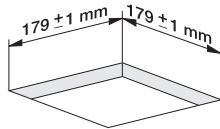

Floor box, 6/8 modules

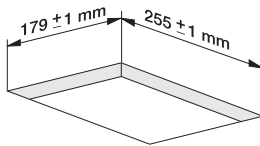

Installation depth

Plastic boxes

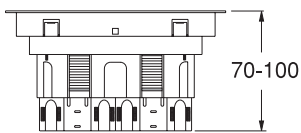

With RCD/MCB

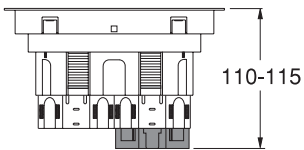

Metal boxes

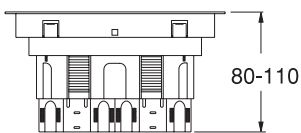

With RCD/MCB

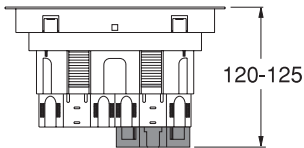

Max. load according to EN 50085-2-2

Plastic floor box 4 modules

Small surface	Force (N)	With stainless steel inlay	Force (N)
Without inlay	3000		3000
Large surface	Force (N)	With stainless steel inlay	Force (N)
Without inlay	5000		5000

Plastic floor box 6/8 modules

Small surface	Force (N)	With stainless steel inlay	Force (N)
Without inlay	2500		3000
Large surface	Force (N)	With stainless steel inlay	Force (N)
Without inlay	5000		5000

Metal floor box 4 modules

Small surface	Force (N)	With stainless steel inlay	Force (N)
Without inlay	3000		3000
Large surface	Force (N)	With stainless steel inlay	Force (N)
Without inlay	10000		10000

Metal floor box 6/8 modules

Small surface	Force (N)	With stainless steel inlay	Force (N)
Without inlay	3000		3000
Large surface	Force (N)	With stainless steel inlay	Force (N)
Without inlay	10000		10000

Dimensions, floor heights

With side-earthed (Schuko type) socket-outlet

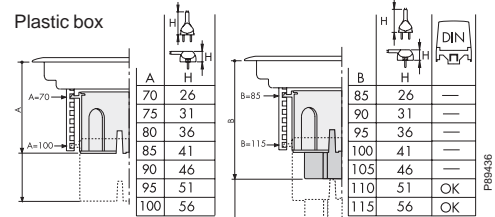

Without base box

With base box

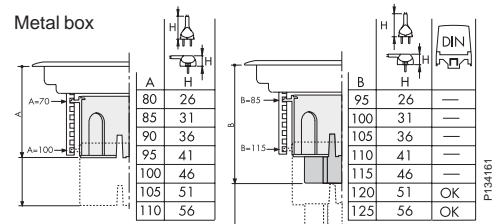

Without base box

With base box

Application picture hollow core box

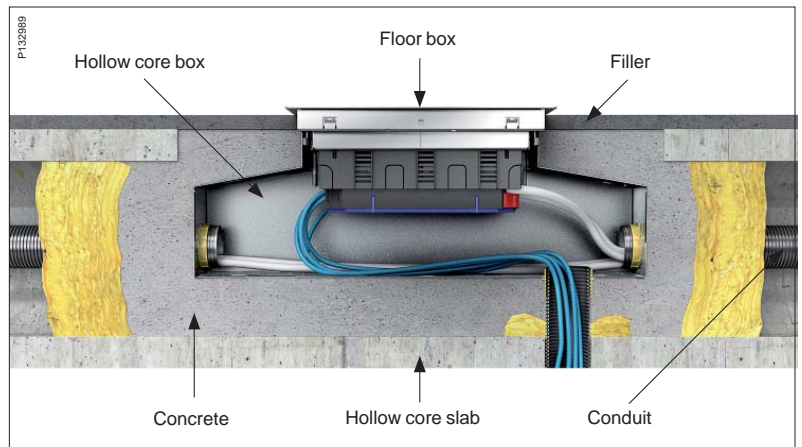

Floor outlet boxes, plastic

Type	Colour	Dimensions A/B/C (mm)	Qty per package	EAN code	Ref. No.
<p>Floor outlet box including mounting frames for Altira, Fuga (DK) or Unica outlets, trim frame with four quick-fixations and lid with cable exit. Also including a plastic bag containing cable holder, partition wall and strain relief devices. The lid can be installed in two positions. It can be fitted with floor material of up to 6 mm thickness. The mounting frames are snapped into the trim frame. The height of the mounting frames is adjustable from 70 mm to 100 mm (boxes for Fuga outlets from 70 mm to 95 mm), in steps of 5 mm. Cable exit capacity 925 mm², max cable Ø12 mm. The floor outlet box is suitable for 45x45 mm single/45x90 mm double Altira/Unica outlets, or for 44x44 mm single/44x94 double Fuga outlets. Material: PA6 with 30% glass pellets, steel. Mounting frame for Altira and Fuga = PC/ABS, for Unica = PBT.</p>					
For Altira outlets					
Four module box, with two mounting frames for two double or four single Altira outlets	Grey	72/199/199	1	3606480030932	ISM50624
Six module box, with three mounting frames for three double or six single Altira outlets	Grey	72/276/199	1	3606480030949	ISM50636
Eight module box, with two mounting frames for four double or eight single Altira outlets	Grey	72/276/199	1	3606480030956	ISM50638
For Fuga outlets (only intended for Denmark)					
Four-module box, with two mounting frames for two double or four single Fuga outlets	Grey	72/199/199	1	3606480150326	ISM50724
Six-module box, with three mounting frames for three double or six single Fuga outlets	Grey	72/276/199	1	3606480150333	ISM50736
For Unica outlets					
Four module box, with two mounting frames for two double or four single Unica outlets	Grey	72/199/199	1	3606480030895	ISM50524
Six module box, with three mounting frames for three double or six single Unica outlets	Grey	72/276/199	1	3606480030928	ISM50536
Eight module box, with two mounting frames for four double or eight single Unica outlets	Grey	72/276/199	1	3606480030925	ISM50538

Floor outlet boxes, metal

<p>Floor outlet box including mounting frames for Altira, Fuga (DK) or Unica outlets, trim frame with four quick-fix devices and lid with cable exit. Also including a plastic bag containing cable holder, partition wall and strain relief devices. The lid can be installed in two positions and can be fitted with an insert material of up to 15 mm thickness. The mounting frames are snapped into the trim frame. The height of the mounting frames is adjustable from 80 mm to 110 mm (boxes for Fuga outlets from 80 mm to 105 mm), in steps of 5 mm. Cable exit capacity 1245 mm², max cable Ø15 mm. The floor outlet box is suitable for 45x45 mm single/45x90 mm double Altira/Unica outlets, or for 44x44 mm single/44x94 double Fuga outlets. Material: Stainless steel. Mounting frame for Altira and Fuga = PC/ABS, for Unica = PBT. Grid = ABS.</p>					
For Altira outlets					
Four module box with two mounting frames for two double or four single Altira outlets	—	83/199/199	1	3606480482465	ISM51624
Six module box with three mounting frames for three double or six single Altira outlets	—	82/276/199	1	3606480483110	ISM51636
Eight module box with two mounting frames for four double or eight single Altira outlets	—	82/276/199	1	3606480483127	ISM51638

Floor outlet boxes, metal

Type	Colour	Dimensions A/B/C (mm)	Qty per package	EAN code	Ref. No.
For Fuga outlets (only intended for Denmark)					
Four-module box, with two mounting frames for two double or four single Fuga outlets	—	83/199/199	1	3606480482472	ISM51724
Six module box with three mounting frames for three double or six single Fuga outlets	—	82/276/199	1	3606480483134	ISM51736
For Unica outlets					
Four module box, with two mounting frames for two double or four single Unica outlets	—	83/199/199	1	3606480482458	ISM51524
Six module box with three mounting frames for three double or six single Unica outlets	—	82/276/199	1	3606480483097	ISM51536
Eight module box with two mounting frames for four double or eight single Unica outlets	—	82/276/199	1	3606480483103	ISM51538

Floor access boxes



Floor access box including trim frame with four quick-fix devices and screw-fixed lid. The lid can be fitted with floor material of up to 6 mm thickness or with the lid infill accessory. To be used together with screeded floor box of PP or steel in screeded floors or direct in raised access floors.
Material: PA6 with 30% glass pellets, steel.

Square	Grey	33/199/199	1	3606480030888	ISM50520
Rectangular	Grey	33/276/199	1	3606480030901	ISM50530



Screeded floor boxes

Plastic boxes					
Plastic screeded floor box for embedment in screeded floors from 75 to 95 mm thickness. With cut-outs for floor trunking and conduits Ø 25 and 40 mm. Including fixing screws for the mounting of floor boxes. Material: PP.					
For 4 mod. floor outlet boxes/ square access boxes and up to 150 mm wide floor trunking	Light grey	75-95/188/188	1	3606480030789	ISM50320
For 6/8 mod. floor outlet boxes/ rect. access boxes and up to 200 mm wide floor trunking	Light grey	75-95/188/265	1	3606480030819	ISM50330
Metal boxes					
Metal screeded floor box for embedment in screeded floors with minimum 100 mm thickness. With openings for feeding on all four sides, equipped with blank plates on three sides. Suitable for both flush floor trunking and tube feeding. The screeded floor box has an adjustable internal height of between 98 and 125 mm. When used in a thicker floor, adjustable supporters should be used. NOTE: Please be aware of the minimum bending radius of cabling during wiring and installation of the floor outlet box. Material: Sheet steel.					
Screeded floor box 4 modules	—	125/302/405	1	3606480482496	ISM50343
Screeded floor box 6/8 modules	—	124/301/482	1	3606480483059	ISM50342
Adjustable supporter					
Adjustable supporter, intended for height adjustment of the screeded floor box to the finished floor level. To be used for cast floors with a thickness ranging from 126 to 290 mm. Material: PP, PA6.					
Supporter	Grey, black	111/111/63-255	4	3606480297977	ISM50341

Screeded floor boxes

Type	Colour	Dimensions A/B/C (mm)	Qty per package	EAN code	Ref. No.
<p>Metal screeded floor box including trunking adaptors, for embedment in screeded floors from 75 to 110 mm thickness. Adaptors on all four sides. In order to mount floor outlet and floor access boxes properly in the steel box, the use of swivel fixings (ISM50823) is recommended. Material: Sheet steel.</p>					
 P85808	For 4 mod. floor outlet boxes/ square access boxes and up to 200 mm wide floor trunking	—	75-110/350/350	1	3606480030796 ISM50322
	For 6/8 mod. floor outlet boxes/ rect. access boxes and up to 200 mm wide floor trunking	—	75-110/350/350	1	3606480030826 ISM50332
	For 4 mod. floor outlet boxes/ square access boxes and up to 350 mm wide floor trunking	—	75-110/500/500	1	3606480030802 ISM50323
	For 6/8 mod. floor outlet boxes/ rect. access boxes and up to 350 mm wide floor trunking	—	75-110/500/500	1	3606480030833 ISM50333
<p>Adaptors for steel box</p> <p>Adaptor with break-out openings for conduits, to be fitted in screeded floor boxes ISM50322, 50332, 50323, 50333. Intended for the connection of 1–4 or 1–6 conduits Ø 25 and 40 mm. Material: Sheet steel, galvanized.</p>					
 P85846	For 1–4 conduits Ø 25 or 40 mm	—	83/1.5/252	5	3606480030840 ISM50392
	For 1–6 conduits Ø 25 or 40 mm	—	83/1.5/403	5	3606480030857 ISM50393
<p>Blank plate to be fitted in the screeded floor box. Material: Sheet steel, galvanized.</p>					
 P85847	Blank plate	—	83/1.5/252	5	3606480030864 ISM50394
		—	83/1.5/403	5	3606480030871 ISM50395

Hollow core box

<p>Hollow core box</p> <p>Metal screeded floor box for embedment in the cavity of hollow core slabs. With knock-outs for pipe adaptors, four upwards, 2x3 sideways and four downwards. Equipped with brackets for rough height fixation 0-75 mm and fine-adjustment screws for fine tuning to the finished floor level. The top entry is covered with a lid for good safety during the construction time. Suitable for 6/8 module floor box. Material: Sheet steel.</p>					
 P131349	Hollow core box 6/8 modules	—	164/502/184	1	3606480483066 ISM50356
	<p>Conduit adaptors</p> <p>Conduit adaptor for two conduits 20 mm. Material: PP.</p>				
 P131533	Conduit adaptor 2x20 mm	Yellow	58/58/32	10	3606480483073 ISM50370
	<p>Conduit adaptor for conduits 25, 32, 40 or 50 mm. Diameter choice by punching out to right size. Material: PP.</p>				
 P131534	Conduit adaptor 1x25, 32, 40 or 50 mm	Yellow	58/58/32	10	3606480483080 ISM50371



Accessories

<p>Mounting frame for Altira outlets</p> <p>Mounting frame for floor outlet box (the 139 mm mounting frame for both floor box sizes, the 216 mm mounting frame only for the rectangular ones). Suitable for single or double Altira outlets. For DIN devices the mounting frame must be combined with the corresponding size of base box. Material: PC/ABS.</p>					
 P85804 P85841	For two single or one double outlet, both floor box sizes	Anthracite grey	38/64/139	6	3606480031021 ISM50809
	For four single or two double outlets, rectangular floor box	Anthracite grey	38/64/216	4	3606480031038 ISM50810

Accessories

	Type	Colour	Dimensions A/B/C (mm)	Qty per package	EAN code	Ref. No.
Mounting frame for Unica outlets						
Mounting frame for floor outlet box (the 139 mm mounting frame for both floor box sizes, the 216 mm mounting frame only for the rectangular ones). Suitable for single or double Unica outlets. For DIN devices the mounting frame must be combined with the corresponding size of base box. Material: PBT with 30% glass-fibre.						
P86466		Grey	38/64/139	6	3606480030987	ISM50805
P86940		Grey	38/64/216	4	3606480030994	ISM50806
Base box						
Base box to be combined with the mounting frame in order to fulfil IP20 (the 126 mm base box for both floor box sizes, the 203 mm base box only for the rectangular ones). Should also be used when mounting DIN devices. Material: PA6.						
P85635		Blue	23/64/126	10	3606480030963	ISM50800
P85836		Blue	23/64/203	10	3606480030970	ISM50801
Lid infill, linoleum						
Lid infill to be used in the lid of floor outlet boxes and floor access boxes. Provided with self-adhesive tape underneath. If the lid infill is to be used in a metal floor box, a 9 mm thick extra spacer material is required. Material: Linoleum.						
P86943		Grey	6/139/167	1	3606480031007	ISM50807
P85844		Grey	6/139/245	1	3606480031014	ISM50808
Lid infill, stainless steel						
Lid infill to be used in the lid of floor outlet boxes and floor access boxes. Provided with a protective film on the upper surface and a soft rubber layer with self-adhesive tape underneath. If the lid infill is to be used in a metal floor box, a 9 mm thick extra spacer material is required. Material: Stainless steel, rubber.						
P83897		—	6/139/167	1	3606480025778	ISM50817
P83898		—	6/139/245	1	3606480025761	ISM50818
Modular device kit, Altira						
Modular device kit for DIN devices, including DIN-rail and transparent grey cover with white frame. Suitable for one or two 18 mm DIN devices, e.g. miniature circuit breakers. To be used only in combination with mounting frame for Altira outlets and blue base box. Material: PC+ASA (DIN-rail), PC/ABS and PC (cover with frame).						
P92622		White	72/45/90	1	3606480031045	ISM50811
Swivel fixing						
Swivel fixings to be mounted on each side of the floor outlet and access boxes. Intended for use as fixing method in screeded floor boxes of steel, and as additional fixing method in raised floors with a thickness ranging from 23 mm to 53 mm. Material: PA6, steel.						
P117438		Blue	58/12/25	2	3606480031052	ISM50823
Flexible conduit						
Flexible conduit (split tube), diameter 25 mm, to be used for cable feeding from floor outlet box to desktop. Cables to be installed by using mounting tool ISM50852. Material: PP.						
P86091		Grey metallic	Ø25/2000	2	3606480150340	ISM50850

Accessories

		Type	Colour	Dimensions A/B/C (mm)	Qty per package	EAN code	Ref. No.
PI65094		Mounting tool					
		Mounting tool for installation of cables in 25 mm split-tube flexible conduits. Material: PP.					
		Mounting tool	—	115/36/70	1	3606480150357	ISM50852
PI65095		Separation clip					
		Clip to be snap-fitted around two flexible conduits, separating power and low voltage cables. Separation distance between cables = 25 mm. To be mounted at 200 mm intervals. Material: PP.					
		Separation clip	Grey metallic	34/28/70	6	3606480160776	ISM50851

Compatible steel trunking products

Type	Colour	Dimensions A/B/C (mm)	Qty per package	EAN code	Ref. No.
Underscreed floor trunking with two compartments					
Floor trunking with two compartments and integrated separation wall, intended for embedded use in screeded floors, in combination with screeded floor boxes of plastic or metal. Available in two heights, 28 and 38 mm. Material: Sheet steel, galvanized.					
	150x28 mm	—	28/150/2000	2 m	8428031087913 4260101
	150x38 mm	—	38/150/2000	2 m	8428031087982 4260111
	200x28 mm	—	28/200/2000	2 m	8428031087920 4260102
	200x38 mm	—	38/200/2000	2 m	8428031087999 4260112
Underscreed floor trunking with three compartments					
Floor trunking with three compartments and integrated separation walls, intended for embedded use in screeded floors, in combination with screeded floor boxes of plastic or metal. Available in two heights, 28 and 38 mm. Material: Sheet steel, galvanized.					
	250x28 mm	—	28/250/2000	2 m	8428031087968 4260106
	250x38 mm	—	38/250/2000	2 m	8428031088033 4260116
	350x28 mm	—	28/350/2000	2 m	8428031087975 4260107
	350x38 mm	—	38/350/2000	2 m	8428031088040 4260117
Fixation clamp					
Clamp intended to fix a 28 mm high floor trunking to the concrete floor and to hold the position at the screeded floor-box junction. Material: Sheet steel, galvanized.					
	For 150 mm	—	30/157/40	1	8428031147129 ISM50151
	For 200 mm	—	30/257/40	1	8428031147136 ISM50152
	For 250 mm	—	30/307/40	1	8428031147143 ISM50153
	For 350 mm	—	30/357/40	1	8428031147150 ISM50154
Same as above but for 38 mm high floor trunking. Material: Sheet steel, galvanized.					
	For 150 mm	—	40/157/40	1	8428031147167 ISM50156
	For 200 mm	—	40/257/40	1	8428031147174 ISM50157
	For 250 mm	—	40/307/40	1	8428031147181 ISM50158
	For 350 mm	—	40/357/40	1	8428031147198 ISM50159
Vertical corner with two compartments					
Vertical corner with two compartments and an integrated separation wall. Intended to guide cables from vertical to horizontal direction. The bend of the corner is chamfered, allowing a proper bending radius of the cables. Material: Sheet steel, galvanized.					
	For 150x28 mm trunking	—	201/150/201	1	8428031096267 4260133
	For 150x38 mm trunking	—	201/150/201	1	8428031096335 4260140
	For 200x28 mm trunking	—	201/200/201	1	8428031096274 4260134
	For 200x38 mm trunking	—	201/200/201	1	8428031096489 4260141
Vertical corner with three compartments					
Vertical corner with three compartments and two integrated separation walls. Intended to guide cables from vertical to horizontal direction. The bend of the corner is chamfered, allowing a proper bending radius of the cables. Material: Sheet steel, galvanized.					
	For 250x28 mm trunking	—	201/250/201	1	8428031096311 4260138
	For 250x38 mm trunking	—	201/250/201	1	8428031096526 4260145
	For 350x28 mm trunking	—	201/350/201	1	8428031096328 4260139
	For 350x38 mm trunking	—	201/350/201	1	8428031096533 4260146
Earthing kit					
Kit including earth wire with flat pin connectors and earthing clamps. Intended to provide an earth connection between two metal floor trunking bodies, or other sheet metal products. Material: Spring steel, copper.					
	Earthing kit	Yellow/green	L = 200	10	3606480028519 ISM10953
			L = 300	10	3606480028526 ISM10954

Compatible Thorsman UFB products

Type	Colour	Dimensions A/B/C (mm)	Qty per package	EAN code	Ref. No.
Conduit adaptor					
Adaptor for the connection of 1–4 conduits to the screeded floor box. The adaptor has four openings for Ø 50 mm (dimensions acc. to EN 60423) conduits. For smaller diameters, reduction sleeves can be used. They are easily pushed into the open ends of the adaptor. All entrances are provided with a knock-out opening on the inside to prevent unintentional leakage of concrete into the screeded box when the entrance is not in use. Material: PP.					
UFB-AP	Yellow	55/40/257	10	7315885197756	5197755
Reduction sleeve					
Reduction sleeve for the fitting of conduits smaller than Ø 50 mm in adaptor UFB-AP. The reduction sleeve is available for four different dimensions: Ø 16, Ø 20, Ø 32 and Ø 40 mm (dimensions acc. to EN 60423). The opening for the feeding conduit should be positioned at the bottom edge of the reduction sleeve, for a stable position of the conduit. Material: PP.					
UFB-RM For conduits Ø 16 mm	Yellow	Ø50/39	10	7315885197824	5197820
UFB-RM For conduits Ø 20 mm	Yellow	Ø50/39	10	7315880046820	5197825
UFB-RM For conduits Ø 32 mm	Yellow	Ø50/39	10	7315885197831	5197830
UFB-RM For conduits Ø 40 mm	Yellow	Ø50/39	10	7315880046837	5197835
Floor trunking adaptor for 28 mm high trunking					
Adaptor to be fitted to the side entrance of the screeded floor box for the connection of 28 mm high floor trunking to the box. Material: Sheet steel S 235 JR.					
UFB-AP For 150x28 mm floor trunking	—	55/40/257	10	7332418017633	5197761
UFB-AP For 200x28 mm floor trunking	—	55/40/257	10	7332418017640	5197762
UFB-AP For 250x28 mm floor trunking	—	55/40/282	10	7332418017657	5197763
Floor trunking adaptor for 38 mm high trunking					
Adaptor to be fitted to the side entrance of the screeded floor box for the connection of 38 mm high floor trunking to the box. Material: Sheet steel S 235 JR.					
UFB-AP For 150x38 mm floor trunking	—	55/40/257	10	7332418017664	5197771
UFB-AP For 200x38 mm floor trunking	—	55/40/257	10	7332418017671	5197772
UFB-AP For 250x38 mm floor trunking	—	55/40/282	10	7332418017688	5197773