

OUTDOOR UNIT BRANCH PIPE INSTALLATION MANUAL

MD17I-008CW
1611170000400

Thank you very much for purchasing our air conditioner, Before using your air conditioner , please read this manual carefully and keep it for future reference.

Branch List

Table.1

Name	Gas side joints	Liquid side joints	Heat insulation material
FQZHW-02N1E			
FQZHW-03N1E			

Choice

Branch pipes for outdoor unit

Table.2

Quantity of outdoor units	Branch pipe
2	FQZHW-02N1E
3	FQZHW-03N1E

Pipe Size

Please select and install the branch pipe according to outdoor unit installation manual and actual installation conditions.

Heat insulation

Be sure to insulate the branches against heat

1) Example of connected branch.

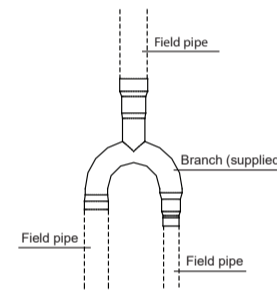

2) Use the supplied heat insulation material to insulate the branches against heat.

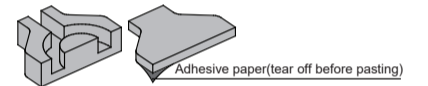

3) Apply the heat insulation material and seal all connections with tape.

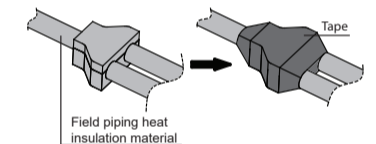

Incision

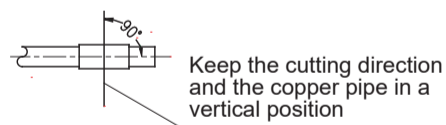
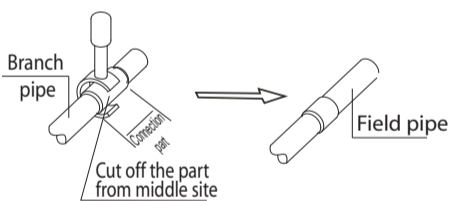

Horizontally Placing Branch Pipe

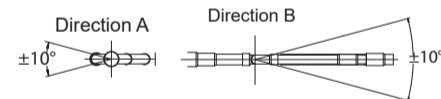

A horizontally incline angle should not larger than 10°.

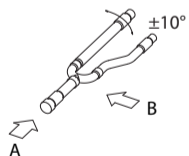

Installation Precaution

1) Pay attention to the distance of straight horizontal pipe.

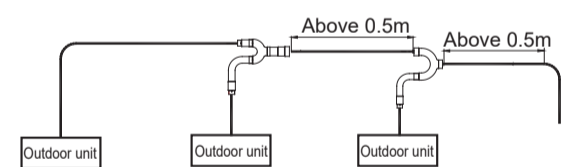

- The straight horizontal pipe's distance between two adjacent branch pipes should $\geq 0.5m$.
- The straight horizontal pipe's distance which outdoor unit connecting behind the branch pipe should $\geq 0.5m$.

Installation Notices

- Select the proper branch model according to table.2.
- According to the actual piping size and cut off the needless parts with special tools such as cutter, take the FQZHW-02N1E gas side for example and the operating steps as follow:
 - When selecting model FQZHW-02N1E, the actual object as display in Fig.1, and then suppose that the outlet pipe of the machine is $\Phi 31.8$, main pipe is $\Phi 38.1$. As display in Fig.2, cut the standalone connecting pipe Q1 of the branch pipe component.
 - As display in Fig.2, weld the standalone connecting pipe Q1, Q3 with the U-shape three direct links Q4; abandon the standalone connecting pipe Q2 because selected pipe size $\Phi 31.8$ can directly connect with the un-welded side of U-shape three direct links.
 - As display in Fig.3, weld the branch pipe components with the field pipes.
- Particularly notice the followings:
 - When the actual pipe size matches with the un-welded side of U-shape three direct links, weld the pipe with the U-shape three direct links.
 - For the connecting pipes Q3 and Q7, if they need to be cut, please cut in the bottom of the flaring as display in Fig. 4.

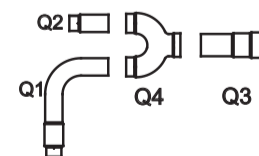

Fig.1

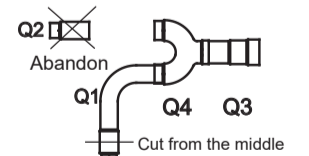

Fig.2

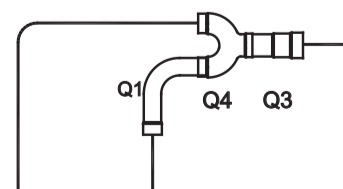

Fig.3

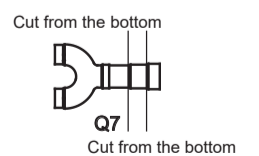
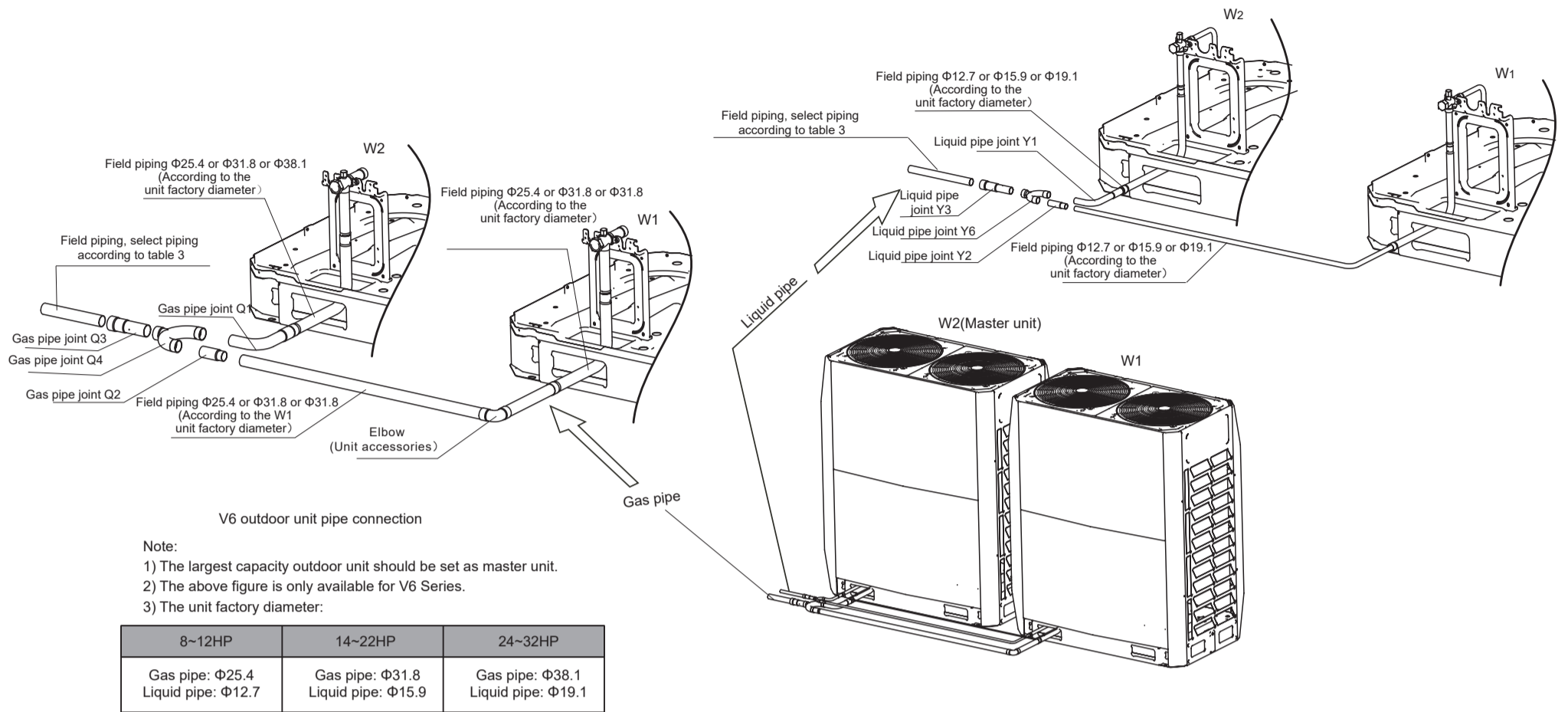

Fig.4

Appearance And Connection Sketch Of FQZHW-02N1E



Appearance And Connection Sketch Of FQZHW-03N1E

