



<b>TEST REPORT</b> <b>IEC 60335-2-40</b> <b>Safety of household and similar electrical appliances</b> <b>Part 2-40: Particular requirements for electrical heat pumps, air conditioners and dehumidifiers</b>	
Report Number .....	GZES190802275410
Date of issue .....	2019-10-15; Amendment 9: 2021-05-19
Total number of pages .....	178
Applicant's name .....	GD Midea Air-conditioning Equipment Co., Ltd.
Address .....	Lingang Road, Beijiao, Shunde, Foshan, 528311, Guangdong, China
<b>Test specification:</b>	
Standard .....	IEC 60335-2-40:2002 (Fourth Edition) + A1:2005 (incl. Corr.1:2006) + A2:2005 in conjunction with IEC 60335-1:2010 (Fifth Edition)
Test procedure .....	SGS-CSTC
Non-standard test method .....	N/A
Test Report Form No. ....	IEC60335_2_40J
Test Report Form(s) Originator .....	VDE
Master TRF .....	Dated 2014-06
<p><b>Copyright © 2014 Worldwide System for Conformity Testing and Certification of Electrotechnical Equipment and Components (IECEE), Geneva, Switzerland. All rights reserved.</b></p> <p>This publication may be reproduced in whole or in part for non-commercial purposes as long as the IECEE is acknowledged as copyright owner and source of the material. IECEE takes no responsibility for and will not assume liability for damages resulting from the reader's interpretation of the reproduced material due to its placement and context.</p> <p>If this Test Report Form is used by non-IECEE members, the IECEE/IEC logo and the reference to the CB Scheme procedure shall be removed.</p> <p><b>This report is not valid as a CB Test Report unless signed by an approved CB Testing Laboratory and appended to a CB Test Certificate issued by an NCB in accordance with IECEE 02.</b></p>	
<b>General disclaimer:</b>	
<p>The test results presented in this report relate only to the object tested.</p> <p>This report shall not be reproduced, except in full, without the written approval of the Issuing CB Testing Laboratory. The authenticity of this Test Report and its contents can be verified by contacting the NCB, responsible for this Test Report.</p>	



<b>Test item description</b> .....	Split-Type Air-Conditioner
<b>Trade Mark</b> .....	<b>Midea</b>
<b>Manufacturer</b> .....	Same as applicant
<b>Model/Type reference</b> .....	<p>Model A: MSAGAU-09HRFN8-QRD0GW Indoor unit: MSAGAU-09HRFNX-QRD0GW; Outdoor unit: MOX102-09HFN8-QRD0GW</p> <p>Model A1: Indoor unit: AG-09NXD0-I; Outdoor unit: X1-09N8D0-O</p> <p>Model B: MSAGBU-09HRFN8-QRD1GW(GA) Indoor unit: MSAGBU-09HRFN8-QRD1GW(GA); Outdoor unit: MOX201-09HFN8-QRD1GW</p> <p>Model B1: Indoor unit: AG-09NXD1-I; Outdoor unit: X2-09N8D1-O</p> <p>Model C: MSAGBU-12HRFN8-QRD0GW Indoor unit: MSAGBU-12HRFNX-QRD0GW; Outdoor unit: MOX102-12HFN8-QRD0GW</p> <p>Model C1: Indoor unit: AG-12NXD0-I; Outdoor unit: X1-12N8D0-O</p> <p>Model D: MSAGCU-18HRFNX-QRD0GW Indoor unit: MSAGCU-18HRFNX-QRD0GW; Outdoor unit: MOX301-18HFN8-QRD0GW</p> <p>Model D1: Indoor unit: AG-18NXD0-I; Outdoor unit: X3-18N8D0-O</p> <p>Model E: MSAGDU-24HRFN8-QRD0GW Indoor unit: MSAGDU-24HRFN8-QRD0GW; Outdoor unit: MOX401-24HFN8-QRD0GW</p> <p>Model E1: Indoor unit: AG-24NXD0-I; Outdoor unit: X4-24N8D0-O</p> <p>Model F: MSAGBU-12HRFN8-QRD1GW(GA) Indoor unit: MSAGBU-12HRFN8-QRD1GW(GA); Outdoor unit: MOX201-12HFN8-QRD1GW</p> <p>Model F1: Indoor unit: AG-12NXD1-I; Outdoor unit: X2-12N8D1-O</p> <p>Model G: MSAGBU-09HRFN8-QRD6GW Indoor unit: MSAGBU-09HRFN8-QRD1GW(GA); Outdoor unit: MOX230-09HFN8-QRD6GW</p> <p>Model H: MSAGBU-12HRFN8-QRD6GW Indoor unit: MSAGBU-12HRFN8-QRD1GW(GA); Outdoor unit: MOX230-12HFN8-QRD6GW</p> <p>Model G1: Indoor unit: AG-09NXD1-I; Outdoor unit: X2-09N8D6-O</p> <p>Model H1: Indoor unit: AG-12NXD1-I; Outdoor unit: X2-12N8D6-O</p>
<b>Ratings</b> .....	<p>220 V – 240 V; 50 Hz;</p> <p>Model A, A1, B, B1, C, C1, F, F1: 2150 W; 10,0 A</p> <p>Model D, D1: 2500 W; 13,0 A</p> <p>Model E, E1: 3700 W; 19,0 A</p> <p>Model G, H, G1, H1: 2200 W; 10,5 A</p>

<b>Testing procedure and testing location:</b>	
<input checked="" type="checkbox"/> <b>CB Testing Laboratory:</b>	SGS-CSTC Standards Technical Services Co., Ltd. Shunde Branch
<b>Testing location/ address .....</b>	Building 1, European Industrial Park, No. 1, Shunhe South Road, Wusha, Daliang, Shunde District, Foshan, Guangdong, China
<input type="checkbox"/> <b>Associated CB Testing Laboratory:</b>	N/A
<b>Testing location/ address .....</b>	
<b>Tested by (name + signature) .....</b>	Project engineer: <i>Alex Leong</i> Alex Leong
<b>Approved by (name + signature) .....</b>	Reviewer: <i>Mike Liu</i> Mike Liu
<input type="checkbox"/> <b>Testing procedure: TMP/CTF Stage 1:</b>	N/A
<b>Testing location/ address .....</b>	
<b>Tested by (name + signature) .....</b>	
<b>Approved by (name + signature) .....</b>	
<input type="checkbox"/> <b>Testing procedure: WMT/CTF Stage 2:</b>	N/A
<b>Testing location/ address .....</b>	
<b>Tested by (name + signature) .....</b>	
<b>Witnessed by (name + signature) .....</b>	
<b>Approved by (name + signature) .....</b>	
<input type="checkbox"/> <b>Testing procedure: SMT/CTF Stage 3 or 4:</b>	N/A
<b>Testing location/ address .....</b>	
<b>Tested by (name + signature) .....</b>	
<b>Witnessed by (name + signature) .....</b>	
<b>Approved by (name + signature) .....</b>	
<b>Supervised by (name + signature).....</b>	

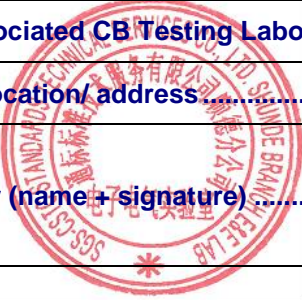

**List of Attachments:**

Attachment 1 includes 16 pages of European group differences and national differences  
 Attachment 2 includes 1 page of EN 60335-1:2012/ A11: 2014  
 Attachment 3 includes 1 page of EN 60335-1: 2012 / A13: 2017  
 Attachment 4 includes 2 pages of circuit diagram  
 Attachment 5 includes 68 pages of photo documentation  
 Attachment 6 includes 6 pages of EN 60335-1: 2012 / A1: 2019 + A14: 2019 + A2: 2019

**Summary of testing:****Tests performed (name of test and test clause):**

Tests according to the following standards were carried out:  
 EN 60335-2-40: 2003 + A11: 2004 + A12: 2005 + A1: 2006 + A2: 2009 + A13: 2012  
 EN 60335-1: 2012 + A11: 2014 + A13: 2017 + A1: 2019 + A14: 2019 + A2: 2019  
 EN 62233: 2008

All models subjected to full tests.

**Amendment-1:**

After view, test clause 10, 11, 13, 30 and construction test were considered necessary for model F.

**Amendment-2:**

After reviewing, no test considered necessary.

**Amendment-3:**

After reviewing, model E subjected to test of clause 10, 11, 13, 15, 16, 19, 29, 30 and Annex N.

**Amendment 4:**

After reviewing, all models subjected to test of 30.

**Amendment 5:**

After reviewing, model H subjected to full tests.

**Amendment 6:**

After reviewing, model C subjected to test of clause 10, 11, 13, 15.3, 16, 19.2, 29, 30 and Annex N.

**Amendment 7:**

After review, the alternative components were selected for clause 30 and Annex E.

**Amendment 8:**

After reviewing, the alternative component was selected for clause 30.

**Amendment 9:**

After reviewing, no test considered necessary.

The submitted appliances complied with above standards

**Testing location:**









See page 3

























**Summary of compliance with National Differences:**

Including CENELEC common modifications and national differences

**Copy of marking plate:**

The artwork below may be only a draft. The use of certification marks on a product must be authorized by the respective NCBs that own these marks.

SPLIT TYPE AIR CONDITIONER		SPLIT TYPE AIR CONDITIONER		SPLIT TYPE AIR CONDITIONER		SPLIT TYPE AIR CONDITIONER	
INDOOR MODEL	MSAGBU-09HRFN8-ORD1GWGA	INDOOR MODEL	MSAGAU-09HRFNX-QRD0GW	OUTDOOR MODEL	MOX102-09HFN8-QRD0GW	OUTDOOR MODEL	MOX201-09HFN8-ORD1GW
COOLING CAPACITY	9000Btu/h	COOLING CAPACITY	9000Btu/h	POWER SOURCE	220-240V~ 50Hz, 1Ph	POWER SOURCE	220-240V~ 50Hz, 1Ph
HEATING CAPACITY	10000Btu/h	HEATING CAPACITY	10000Btu/h	MAXIMUM ALLOWABLE PRESSURE	4.4MPa	MAXIMUM ALLOWABLE PRESSURE	4.4MPa
POWER SOURCE	220-240V~ 50Hz, 1Ph	POWER SOURCE	220-240V~ 50Hz, 1Ph	EXCESSIVE OPERATING PRESSURE	DISCHARGE 4.3MPa SUCTION 1.7MPa	EXCESSIVE OPERATING PRESSURE	DISCHARGE 4.3MPa SUCTION 1.7MPa
INDOOR RATED CURRENT	/	INDOOR RATED CURRENT	/	REFRIGERANT	R32/0.6kg	REFRIGERANT	R32/0.62kg
INDOOR RATED INPUT	23.0W	INDOOR RATED INPUT	21.0W	RATED CURRENT	10.0A	RATED CURRENT	10.0A
 <p>For specific information on the type of gas and the amount, please refer to the label on the outdoor unit.</p>		 <p>For specific information on the type of gas and the amount, please refer to the label on the outdoor unit.</p>		 <p>Contains fluorinated greenhouse gases. GWP: 675; 0.41 tonnes CO<sub>2</sub> equivalent.</p>		 <p>Contains fluorinated greenhouse gases. GWP: 675; 0.418 tonnes CO<sub>2</sub> equivalent.</p>	
							

<p><b>SPLIT TYPE AIR CONDITIONER</b></p> <table border="1"> <tr><td>INDOOR MODEL</td><td>MSAGBU-12HRFN-QRD0GW</td></tr> <tr><td>COOLING CAPACITY</td><td>12000Btu/h</td></tr> <tr><td>HEATING CAPACITY</td><td>13000Btu/h</td></tr> <tr><td>POWER SOURCE</td><td>220-240V~ 50Hz, 1Ph</td></tr> <tr><td>INDOOR RATED CURRENT</td><td>/</td></tr> <tr><td>INDOOR RATED INPUT</td><td>23.0W</td></tr> </table> <p> </p> <p>For specific information on the type of gas and the amount, please refer to the label on the outdoor unit.</p> <p>Importer: xxx Manufacturer: GD Midea Air-Conditioning Equipment Co., Ltd. Lingang Road Beijiao Shunde Foshan Guangdong People's Republic of China 528311</p> <p></p>	INDOOR MODEL	MSAGBU-12HRFN-QRD0GW	COOLING CAPACITY	12000Btu/h	HEATING CAPACITY	13000Btu/h	POWER SOURCE	220-240V~ 50Hz, 1Ph	INDOOR RATED CURRENT	/	INDOOR RATED INPUT	23.0W	<p><b>SPLIT TYPE AIR CONDITIONER</b></p> <table border="1"> <tr><td>OUTDOOR MODEL</td><td>MOX102-12HFN-QRD0GW</td></tr> <tr><td>POWER SOURCE</td><td>220-240V~ 50Hz, 1Ph</td></tr> <tr><td>MAXIMUM ALLOWABLE PRESSURE</td><td>4.4MPa</td></tr> <tr><td>EXCESSIVE OPERATING PRESSURE</td><td>DISCHARGE 4.3MPa SUCTION 1.7MPa</td></tr> <tr><td>REFRIGERANT</td><td>R32/0.65kg</td></tr> <tr><td>RATED CURRENT</td><td>10.0A</td></tr> <tr><td>RATED INPUT</td><td>2150W</td></tr> <tr><td>OUTDOOR UNIT RESISTANCE CLASS</td><td>IP 24</td></tr> </table> <p></p> <p>Contains fluorinated greenhouse gases. GWP: 675; 0.44 tonnes CO<sub>2</sub> equivalent.</p> <p>Importer: xxx Manufacturer: GD Midea Air-Conditioning Equipment Co., Ltd. Lingang Road Beijiao Shunde Foshan Guangdong People's Republic of China 528311</p> <p></p>	OUTDOOR MODEL	MOX102-12HFN-QRD0GW	POWER SOURCE	220-240V~ 50Hz, 1Ph	MAXIMUM ALLOWABLE PRESSURE	4.4MPa	EXCESSIVE OPERATING PRESSURE	DISCHARGE 4.3MPa SUCTION 1.7MPa	REFRIGERANT	R32/0.65kg	RATED CURRENT	10.0A	RATED INPUT	2150W	OUTDOOR UNIT RESISTANCE CLASS	IP 24	<p><b>SPLIT TYPE AIR CONDITIONER</b></p> <table border="1"> <tr><td>INDOOR MODEL</td><td>MSAGCU-18HRFN-QRD0GW</td></tr> <tr><td>COOLING CAPACITY</td><td>18000Btu/h</td></tr> <tr><td>HEATING CAPACITY</td><td>19000Btu/h</td></tr> <tr><td>POWER SOURCE</td><td>220-240V~ 50Hz, 1Ph</td></tr> <tr><td>INDOOR RATED CURRENT</td><td>/</td></tr> <tr><td>INDOOR RATED INPUT</td><td>36.0W</td></tr> </table> <p> </p> <p>For specific information on the type of gas and the amount, please refer to the label on the outdoor unit.</p> <p>Importer: xxx Manufacturer: GD Midea Air-Conditioning Equipment Co., Ltd. Lingang Road Beijiao Shunde Foshan Guangdong People's Republic of China 528311</p> <p></p>	INDOOR MODEL	MSAGCU-18HRFN-QRD0GW	COOLING CAPACITY	18000Btu/h	HEATING CAPACITY	19000Btu/h	POWER SOURCE	220-240V~ 50Hz, 1Ph	INDOOR RATED CURRENT	/	INDOOR RATED INPUT	36.0W	<p><b>SPLIT TYPE AIR CONDITIONER</b></p> <table border="1"> <tr><td>OUTDOOR MODEL</td><td>MOX301-18HFN-QRD0GW</td></tr> <tr><td>POWER SOURCE</td><td>220-240V~ 50Hz, 1Ph</td></tr> <tr><td>MAXIMUM ALLOWABLE PRESSURE</td><td>4.4MPa</td></tr> <tr><td>EXCESSIVE OPERATING PRESSURE</td><td>DISCHARGE 4.3MPa SUCTION 1.7MPa</td></tr> <tr><td>REFRIGERANT</td><td>R32/1.1kg</td></tr> <tr><td>RATED CURRENT</td><td>13.0A</td></tr> <tr><td>RATED INPUT</td><td>2500W</td></tr> <tr><td>OUTDOOR UNIT RESISTANCE CLASS</td><td>IP 24</td></tr> </table> <p></p> <p>Contains fluorinated greenhouse gases. GWP: 675; 0.74 tonnes CO<sub>2</sub> equivalent.</p> <p>Importer: xxx Manufacturer: GD Midea Air-Conditioning Equipment Co., Ltd. Lingang Road Beijiao Shunde Foshan Guangdong People's Republic of China 528311</p> <p></p>	OUTDOOR MODEL	MOX301-18HFN-QRD0GW	POWER SOURCE	220-240V~ 50Hz, 1Ph	MAXIMUM ALLOWABLE PRESSURE	4.4MPa	EXCESSIVE OPERATING PRESSURE	DISCHARGE 4.3MPa SUCTION 1.7MPa	REFRIGERANT	R32/1.1kg	RATED CURRENT	13.0A	RATED INPUT	2500W	OUTDOOR UNIT RESISTANCE CLASS	IP 24
INDOOR MODEL	MSAGBU-12HRFN-QRD0GW																																																										
COOLING CAPACITY	12000Btu/h																																																										
HEATING CAPACITY	13000Btu/h																																																										
POWER SOURCE	220-240V~ 50Hz, 1Ph																																																										
INDOOR RATED CURRENT	/																																																										
INDOOR RATED INPUT	23.0W																																																										
OUTDOOR MODEL	MOX102-12HFN-QRD0GW																																																										
POWER SOURCE	220-240V~ 50Hz, 1Ph																																																										
MAXIMUM ALLOWABLE PRESSURE	4.4MPa																																																										
EXCESSIVE OPERATING PRESSURE	DISCHARGE 4.3MPa SUCTION 1.7MPa																																																										
REFRIGERANT	R32/0.65kg																																																										
RATED CURRENT	10.0A																																																										
RATED INPUT	2150W																																																										
OUTDOOR UNIT RESISTANCE CLASS	IP 24																																																										
INDOOR MODEL	MSAGCU-18HRFN-QRD0GW																																																										
COOLING CAPACITY	18000Btu/h																																																										
HEATING CAPACITY	19000Btu/h																																																										
POWER SOURCE	220-240V~ 50Hz, 1Ph																																																										
INDOOR RATED CURRENT	/																																																										
INDOOR RATED INPUT	36.0W																																																										
OUTDOOR MODEL	MOX301-18HFN-QRD0GW																																																										
POWER SOURCE	220-240V~ 50Hz, 1Ph																																																										
MAXIMUM ALLOWABLE PRESSURE	4.4MPa																																																										
EXCESSIVE OPERATING PRESSURE	DISCHARGE 4.3MPa SUCTION 1.7MPa																																																										
REFRIGERANT	R32/1.1kg																																																										
RATED CURRENT	13.0A																																																										
RATED INPUT	2500W																																																										
OUTDOOR UNIT RESISTANCE CLASS	IP 24																																																										
<p><b>SPLIT TYPE AIR CONDITIONER</b></p> <table border="1"> <tr><td>INDOOR MODEL</td><td>MSAGDU-24HRFN-QRD0GW</td></tr> <tr><td>COOLING CAPACITY</td><td>24000Btu/h</td></tr> <tr><td>HEATING CAPACITY</td><td>25000Btu/h</td></tr> <tr><td>POWER SOURCE</td><td>220-240V~ 50Hz, 1Ph</td></tr> <tr><td>INDOOR RATED CURRENT</td><td>/</td></tr> <tr><td>INDOOR RATED INPUT</td><td>68.0W</td></tr> </table> <p> </p> <p>For specific information on the type of gas and the amount, please refer to the label on the outdoor unit.</p> <p>Importer: xxx Manufacturer: GD Midea Air-Conditioning Equipment Co., Ltd. Lingang Road Beijiao Shunde Foshan Guangdong People's Republic of China 528311</p> <p></p>	INDOOR MODEL	MSAGDU-24HRFN-QRD0GW	COOLING CAPACITY	24000Btu/h	HEATING CAPACITY	25000Btu/h	POWER SOURCE	220-240V~ 50Hz, 1Ph	INDOOR RATED CURRENT	/	INDOOR RATED INPUT	68.0W	<p><b>SPLIT TYPE AIR CONDITIONER</b></p> <table border="1"> <tr><td>OUTDOOR MODEL</td><td>MOX401-24HFN-QRD0GW</td></tr> <tr><td>POWER SOURCE</td><td>220-240V~ 50Hz, 1Ph</td></tr> <tr><td>MAXIMUM ALLOWABLE PRESSURE</td><td>4.4MPa</td></tr> <tr><td>EXCESSIVE OPERATING PRESSURE</td><td>DISCHARGE 4.3MPa SUCTION 1.7MPa</td></tr> <tr><td>REFRIGERANT</td><td>R32/1.45kg</td></tr> <tr><td>RATED CURRENT</td><td>19.0A</td></tr> <tr><td>RATED INPUT</td><td>3700W</td></tr> <tr><td>OUTDOOR UNIT RESISTANCE CLASS</td><td>IP 24</td></tr> </table> <p></p> <p>Contains fluorinated greenhouse gases. GWP: 675; 0.978 tonnes CO<sub>2</sub> equivalent.</p> <p>Importer: xxx Manufacturer: GD Midea Air-Conditioning Equipment Co., Ltd. Lingang Road Beijiao Shunde Foshan Guangdong People's Republic of China 528311</p> <p></p>	OUTDOOR MODEL	MOX401-24HFN-QRD0GW	POWER SOURCE	220-240V~ 50Hz, 1Ph	MAXIMUM ALLOWABLE PRESSURE	4.4MPa	EXCESSIVE OPERATING PRESSURE	DISCHARGE 4.3MPa SUCTION 1.7MPa	REFRIGERANT	R32/1.45kg	RATED CURRENT	19.0A	RATED INPUT	3700W	OUTDOOR UNIT RESISTANCE CLASS	IP 24	<p><b>SPLIT TYPE AIR CONDITIONER</b></p> <table border="1"> <tr><td>INDOOR MODEL</td><td>MSAGBU-2HRFN-QRD1GW</td></tr> <tr><td>COOLING CAPACITY</td><td>12000Btu/h</td></tr> <tr><td>HEATING CAPACITY</td><td>13000Btu/h</td></tr> <tr><td>POWER SOURCE</td><td>220-240V~ 50Hz, 1Ph</td></tr> <tr><td>INDOOR RATED CURRENT</td><td>/</td></tr> <tr><td>INDOOR RATED INPUT</td><td>23.0W</td></tr> </table> <p> </p> <p>For specific information on the type of gas and the amount, please refer to the label on the outdoor unit.</p> <p>Importer: xxx Manufacturer: GD Midea Air-Conditioning Equipment Co., Ltd. Lingang Road Beijiao Shunde Foshan Guangdong People's Republic of China 528311</p> <p></p>	INDOOR MODEL	MSAGBU-2HRFN-QRD1GW	COOLING CAPACITY	12000Btu/h	HEATING CAPACITY	13000Btu/h	POWER SOURCE	220-240V~ 50Hz, 1Ph	INDOOR RATED CURRENT	/	INDOOR RATED INPUT	23.0W	<p><b>SPLIT TYPE AIR CONDITIONER</b></p> <table border="1"> <tr><td>OUTDOOR MODEL</td><td>MOX201-12HFN-QRD1GW</td></tr> <tr><td>POWER SOURCE</td><td>220-240V~ 50Hz, 1Ph</td></tr> <tr><td>MAXIMUM ALLOWABLE PRESSURE</td><td>4.4MPa</td></tr> <tr><td>EXCESSIVE OPERATING PRESSURE</td><td>DISCHARGE 4.3MPa SUCTION 1.7MPa</td></tr> <tr><td>REFRIGERANT</td><td>R32/0.62kg</td></tr> <tr><td>RATED CURRENT</td><td>10.0A</td></tr> <tr><td>RATED INPUT</td><td>2150W</td></tr> <tr><td>OUTDOOR UNIT RESISTANCE CLASS</td><td>IP 24</td></tr> </table> <p></p> <p>Contains fluorinated greenhouse gases. GWP: 675; 0.42 tonnes CO<sub>2</sub> equivalent.</p> <p>Importer: xxx Manufacturer: GD Midea Air-Conditioning Equipment Co., Ltd. Lingang Road Beijiao Shunde Foshan Guangdong People's Republic of China 528311</p> <p></p>	OUTDOOR MODEL	MOX201-12HFN-QRD1GW	POWER SOURCE	220-240V~ 50Hz, 1Ph	MAXIMUM ALLOWABLE PRESSURE	4.4MPa	EXCESSIVE OPERATING PRESSURE	DISCHARGE 4.3MPa SUCTION 1.7MPa	REFRIGERANT	R32/0.62kg	RATED CURRENT	10.0A	RATED INPUT	2150W	OUTDOOR UNIT RESISTANCE CLASS	IP 24
INDOOR MODEL	MSAGDU-24HRFN-QRD0GW																																																										
COOLING CAPACITY	24000Btu/h																																																										
HEATING CAPACITY	25000Btu/h																																																										
POWER SOURCE	220-240V~ 50Hz, 1Ph																																																										
INDOOR RATED CURRENT	/																																																										
INDOOR RATED INPUT	68.0W																																																										
OUTDOOR MODEL	MOX401-24HFN-QRD0GW																																																										
POWER SOURCE	220-240V~ 50Hz, 1Ph																																																										
MAXIMUM ALLOWABLE PRESSURE	4.4MPa																																																										
EXCESSIVE OPERATING PRESSURE	DISCHARGE 4.3MPa SUCTION 1.7MPa																																																										
REFRIGERANT	R32/1.45kg																																																										
RATED CURRENT	19.0A																																																										
RATED INPUT	3700W																																																										
OUTDOOR UNIT RESISTANCE CLASS	IP 24																																																										
INDOOR MODEL	MSAGBU-2HRFN-QRD1GW																																																										
COOLING CAPACITY	12000Btu/h																																																										
HEATING CAPACITY	13000Btu/h																																																										
POWER SOURCE	220-240V~ 50Hz, 1Ph																																																										
INDOOR RATED CURRENT	/																																																										
INDOOR RATED INPUT	23.0W																																																										
OUTDOOR MODEL	MOX201-12HFN-QRD1GW																																																										
POWER SOURCE	220-240V~ 50Hz, 1Ph																																																										
MAXIMUM ALLOWABLE PRESSURE	4.4MPa																																																										
EXCESSIVE OPERATING PRESSURE	DISCHARGE 4.3MPa SUCTION 1.7MPa																																																										
REFRIGERANT	R32/0.62kg																																																										
RATED CURRENT	10.0A																																																										
RATED INPUT	2150W																																																										
OUTDOOR UNIT RESISTANCE CLASS	IP 24																																																										
<p><b>SPLIT TYPE AIR CONDITIONER</b></p> <table border="1"> <tr><td>OUTDOOR MODEL</td><td>MOX230-09HFN-QRD6GW</td></tr> <tr><td>POWER SOURCE</td><td>220-240V~ 50Hz, 1Ph</td></tr> <tr><td>MAXIMUM ALLOWABLE PRESSURE</td><td>4.4MPa</td></tr> <tr><td>EXCESSIVE OPERATING PRESSURE</td><td>DISCHARGE 4.3MPa SUCTION 1.7MPa</td></tr> <tr><td>REFRIGERANT</td><td>R32/0.62kg</td></tr> <tr><td>RATED CURRENT</td><td>10.5A</td></tr> <tr><td>RATED INPUT</td><td>2200W</td></tr> <tr><td>OUTDOOR UNIT RESISTANCE CLASS</td><td>IP 24</td></tr> </table> <p></p> <p>Contains fluorinated greenhouse gases. GWP: 675; 0.418 tonnes CO<sub>2</sub> equivalent.</p> <p>Importer: xxx Manufacturer: GD Midea Air-Conditioning Equipment Co., Ltd. Lingang Road Beijiao Shunde Foshan Guangdong People's Republic of China 528311</p> <p></p>	OUTDOOR MODEL	MOX230-09HFN-QRD6GW	POWER SOURCE	220-240V~ 50Hz, 1Ph	MAXIMUM ALLOWABLE PRESSURE	4.4MPa	EXCESSIVE OPERATING PRESSURE	DISCHARGE 4.3MPa SUCTION 1.7MPa	REFRIGERANT	R32/0.62kg	RATED CURRENT	10.5A	RATED INPUT	2200W	OUTDOOR UNIT RESISTANCE CLASS	IP 24	<p><b>SPLIT TYPE AIR CONDITIONER</b></p> <table border="1"> <tr><td>OUTDOOR MODEL</td><td>MOX230-12HFN-QRD6GW</td></tr> <tr><td>POWER SOURCE</td><td>220-240V~ 50Hz, 1Ph</td></tr> <tr><td>MAXIMUM ALLOWABLE PRESSURE</td><td>4.4MPa</td></tr> <tr><td>EXCESSIVE OPERATING PRESSURE</td><td>DISCHARGE 4.3MPa SUCTION 1.7MPa</td></tr> <tr><td>REFRIGERANT</td><td>R32/0.62kg</td></tr> <tr><td>RATED CURRENT</td><td>10.5A</td></tr> <tr><td>RATED INPUT</td><td>2200W</td></tr> <tr><td>OUTDOOR UNIT RESISTANCE CLASS</td><td>IP 24</td></tr> </table> <p></p> <p>Contains fluorinated greenhouse gases. GWP: 675; 0.418 tonnes CO<sub>2</sub> equivalent.</p> <p>Importer: xxx Manufacturer: GD Midea Air-Conditioning Equipment Co., Ltd. Lingang Road Beijiao Shunde Foshan Guangdong People's Republic of China 528311</p> <p></p>	OUTDOOR MODEL	MOX230-12HFN-QRD6GW	POWER SOURCE	220-240V~ 50Hz, 1Ph	MAXIMUM ALLOWABLE PRESSURE	4.4MPa	EXCESSIVE OPERATING PRESSURE	DISCHARGE 4.3MPa SUCTION 1.7MPa	REFRIGERANT	R32/0.62kg	RATED CURRENT	10.5A	RATED INPUT	2200W	OUTDOOR UNIT RESISTANCE CLASS	IP 24																										
OUTDOOR MODEL	MOX230-09HFN-QRD6GW																																																										
POWER SOURCE	220-240V~ 50Hz, 1Ph																																																										
MAXIMUM ALLOWABLE PRESSURE	4.4MPa																																																										
EXCESSIVE OPERATING PRESSURE	DISCHARGE 4.3MPa SUCTION 1.7MPa																																																										
REFRIGERANT	R32/0.62kg																																																										
RATED CURRENT	10.5A																																																										
RATED INPUT	2200W																																																										
OUTDOOR UNIT RESISTANCE CLASS	IP 24																																																										
OUTDOOR MODEL	MOX230-12HFN-QRD6GW																																																										
POWER SOURCE	220-240V~ 50Hz, 1Ph																																																										
MAXIMUM ALLOWABLE PRESSURE	4.4MPa																																																										
EXCESSIVE OPERATING PRESSURE	DISCHARGE 4.3MPa SUCTION 1.7MPa																																																										
REFRIGERANT	R32/0.62kg																																																										
RATED CURRENT	10.5A																																																										
RATED INPUT	2200W																																																										
OUTDOOR UNIT RESISTANCE CLASS	IP 24																																																										



The marking of risk of fire for all models. Letter height: 11 mm.



The marking of symbol ISO 7000-0790; ISO-7000-1641; ISO 700-1659 for all models.  
Letter height: 10 mm.

- 1) The Height of CE logo shall not be less than 5 mm; Height of WEEE logo shall not be less than 7 mm;
- 2) As declared by the applicant, the importer (and manufacturer, if it is different)'s name, registered trade name or registered trade mark and the postal address will be marked on the products before being place on the market. The contact details shall be in a language easily understood by end-users and market surveillance authorities.
- 3) Marking on the packaging or in a document accompanying the electrical equipment is only acceptable if it is not possible to place such markings on the product.

<b>Test item particulars</b> .....	
<b>Classification of installation and use</b> .....	Fixed appliance
<b>Supply Connection</b> .....	Terminal block
<b>Possible test case verdicts:</b>	
- test case does not apply to the test object .....	N/A
- test object does meet the requirement .....	P (Pass)
- test object does not meet the requirement .....	F (Fail)
<b>Testing</b> .....	
<b>Date of receipt of test item</b> .....	2019-09-16, 2019-11-24, 2020-02-10, 2020-03-05; 2020-04-15; 2020-06-01, 2020-07-23, 2020-09-20; 2020-12-01
<b>Date (s) of performance of tests</b> .....	2019-09-20 to 2019-10-08 2019-11-20 to 2019-11-24 2020-03-05 to 2020-03-20 2020-04-15 to 2020-04-16 2020-06-01 to 2020-06-15 2020-07-23 to 2020-08-18 2020-09-20 to 2020-09-22 2020-12-01 to 2020-12-02
<b>General remarks:</b>	
"(See Enclosure #)" refers to additional information appended to the report.	
"(See appended table)" refers to a table appended to the report.	
Throughout this report a <input checked="" type="checkbox"/> comma / <input type="checkbox"/> point is used as the decimal separator.	
This document is issued by the Company subject to its General Conditions of Service, available on request or accessible at <a href="http://www.sgs.com/en/Terms-and-Conditions.aspx">http://www.sgs.com/en/Terms-and-Conditions.aspx</a> and, for electronic format documents, subject to Terms and Conditions for Electronic Documents at <a href="http://www.sgs.com/en/Terms-and-Conditions/Terms-e-Document.aspx">http://www.sgs.com/en/Terms-and-Conditions/Terms-e-Document.aspx</a> . Attention is drawn to the limitation of liability, indemnification and jurisdiction issues defined therein.	
Any holder of this document is advised that information contained hereon reflects the Company's findings at the time of its intervention only and within the limits of Client's instructions, if any. The Company's sole responsibility is to its Client and this document does not exonerate parties to a transaction from exercising all their rights and obligations under the transaction documents. This document cannot be reproduced except in full, without prior written approval of the Company. Any unauthorized alteration, forgery or falsification of the content or appearance of this document is unlawful and offenders may be prosecuted to the fullest extent of the law.	
Unless otherwise stated the results shown in this test report refer only to the sample(s) tested and such sample(s) are retained for 30 days only.	
This TRF includes an <u>appendix EMF</u> containing the IEC/EN 62233 requirements (see below).	
IEC 62233:2005 (1. Edition) EN 62233:2008 (incl. Corr.1:2008)	
<b>IU: Indoor unit, OU: Outdoor unit</b>	
<b>Manufacturer's Declaration per sub-clause 4.2.5 of IEC60002:</b>	

The application for obtaining a CB Test Certificate includes more than one factory location and a declaration from the Manufacturer stating that the sample(s) submitted for evaluation is (are) representative of the products from each factory has been provided.....:	<input checked="" type="checkbox"/> Yes <input type="checkbox"/> Not applicable
---	--

**When differences exist; they shall be identified in the General product information section.**

**Name and address of factory (ies) .....**: 1. GD Midea Air-conditioning Equipment Co., Ltd.  
Lingang Road, Beijiao, Shunde, Foshan, 528311, Guangdong, China  
2. Guangzhou Hualing Refrigerating Equipment Co., Ltd.  
6 Meide 1<sup>st</sup> Road, Zhujiang Industrial Park, Zhujiang Street, Nansha, Guangzhou, China

**General product information:**

Split-type air-conditioner for household use only.  
Appliance had both cooling and heating functions, the refrigerant was R32.  
All models have similar construction.  
After installed, the indoor units shall be complied with the product standards.  
The cord installation or connection shall be according to the national wiring regulation.  
Remote control was supplied by AAA type batteries.

**Amendment 1:**

The original test report No. GZES190802275401 dated 2019-10-15 was modified on 2019-11-25 to include the following addition and change, which were considered technical modifications:

1. Add new model F. Model F was same as model B, while model F has Electronic expansion valve.
2. Add relay, Surge absorber and PCB board for alternative

After view, test clause 10, 11, 13, 30 and construction test were considered necessary for model F.

**Amendment 2:**

The original test report No. GZES190802275401 dated 2019-10-15 was modified on 2020-02-14 to include the following addition and change, which were considered technical modifications:

1. Add new models below which were same as the original models except the model name.

	New model	Original model
A1	AG-09NXD0-I	MSAGAU-09HRFNX-QRD0GW
	X1-09N8D0-O	MOX102-09HFN8-QRD0GW
B1	AG-09NXD1-I	MSAGBU-09HRFN8-QRD1GW(GA)
	X2-09N8D1-O	MOX201-09HFN8-QRD1GW
C2	AG-12NXD0-I	MSAGBU-12HRFNX-QRD0GW
	X1-12N8D0-O	MOX102-12HFN8-QRD0GW
D2	AG-18NXD0-I	MSAGCU-18HRFNX-QRD0GW
	X3-18N8D0-O	MOX301-18HFN8-QRD0GW
E1	AG-24NXD0-I	MSAGDU-24HRFN8-QRD0GW
	X4-24N8D0-O	MOX401-24HFN8-QRD0GW
F1	AG-12NXD1-I	MSAGBU-12HRFN8-QRD1GW(GA)
	X2-12N8D1-O	MOX201-12HFN8-QRD1GW

After reviewing, no test considered necessary.

**Amendment 3:**

The original test report No. GZES190802275401 dated 2019-10-15 was modified on 2020-03-25 to include the following addition and change, which were considered technical modifications:

1. Add alternative indoor fan motor for model E and E1.

After reviewing, model E subjected to test of clause 10, 11, 13, 15, 16, 19, 29, 30 and Annex N.

**Amendment 4:**

The original test report No. GZES190802275401 dated 2019-10-15 was modified on 2020-03-25 to include the following addition and change, which were considered technical modifications:

1. Add alternative varistor, X2 capacitor and IPM, details see table 24.1;

After reviewing, all models subjected to test of 30.

**Amendment 5:**

The original test report No. GZES190802275401 dated 2019-10-15 was modified on 2020-06-18 to include the following addition and change, which were considered technical modifications:

1. Add new model G and H which are all same except the model name.

Indoor unit of model G is same as the indoor unit of model B;

Indoor unit of model H is same as the indoor unit of model F;

After reviewing, model H subjected to full tests.

**Amendment 6:**

The original test report No. GZES190802275401 dated 2019-10-15 was modified on 2020-08-19 to include the following addition and change, which were considered technical modifications:

1. Add alternative fan motor for model B, B1, C, C1, F, F1, G, H, detail see table 24.1.
2. Add alternative X2 capacitor, detail see table 24.1.

After reviewing, model C subjected to test of clause 10, 11, 13, 15.3, 16, 19.2, 29, 30 and Annex N.

**Amendment 7:**

The original test report No. GZES190802275401 dated 2019-10-15 was modified on 2020-09-22 to include the following addition and change, which were considered technical modifications:

1. Add alternative outdoor chassis heater, the new component was same as original except for the lead wire length.
2. Add alternative components: X2 capacitor, 4 way valve and PCB board. Detail see table 24.1.

After review, the alternative components were selected for clause 30 and Annex E.

**Amendment 8:**

The original test report No. GZES190802275401 dated 2019-10-15 was modified on 2020-12-03 to include the following addition and change, which were considered technical modifications:

1. Add alternative relay, detail see table 24.1.

After reviewing, the alternative component was selected for clause 30.

**Amendment 9:**

The original test report No. GZES190802275401 dated 2019-10-15 was modified on 2021-05-19 to include the following addition and change, which were considered technical modifications:

1. Add new models below which were same as the original models except the model name.

New model		Original model
G1	AG-09NXD1-I	MSAGBU-09HRFN8-QRD1GW(GA)
	X2-09N8D6-O	MOX230-09HFN8-QRD6GW
H1	AG-12NXD1-I	MSAGBU-12HRFN8-QRD1GW(GA)
	X2-12N8D6-O	MOX230-12HFN8-QRD6GW

After reviewing, no test considered necessary.

IEC 60335-2-40			
Clause	Requirement + Test	Result - Remark	Verdict
5	GENERAL CONDITIONS FOR THE TESTS		--
	Tests performed according to clause 5, e.g. nature of supply, sequence of testing, etc.		P
5.2	Tests of clause 21 carried out on separate samples. Tests of clauses 11, 19 and 21 require pressure measurements made at various points in refrigerating system (IEC 60335-2-40/A1)		P
	At least one additional specially prepared sample required for tests of annex FF (Leak simulation tests) (IEC 60335-2-40/A1)		N/A
	Temperatures on refrigerant piping measured during test of clause 11 (IEC 60335-2-40/A1)		P
5.6	Appropriate controls rendered inoperative during test (IEC 60335-2-40)		P
5.7	Tests of clauses 10 and 11 carried out under most severe operating conditions within operating temperature range specified by manufacturer. Annex AA provide examples of such temperature conditions (IEC 60335-2-40)		P
5.10	For split-package units, refrigerant lines installed in accordance with installation instructions (IEC 60335-2-40)		P
	Refrigerant line length is maximum length stated in installation instructions or (IEC 60335-2-40)		N/A
	7,5 m, whichever is shorter (IEC 60335-2-40)		P
	Thermal insulation of refrigerant lines applied in accordance with installation instructions (IEC 60335-2-40)		P
5.101	Motor-compressor subjected to relevant test of clause 19 of IEC 60335-2-34, unless (IEC 60335-2-40)		N/A
	motor-compressor comply with that standard (IEC 60335-2-40)		P
5.102	Motor-compressors tested and comply with IEC 60335-2-34 need not additionally tested for clause 21 (IEC 60335-2-40/A1)		P
6	CLASSIFICATION		--
6.1	Protection against electric shock: Class I, II, III (IEC 60335-2-40)..... :	Class I	P
6.2	Protection against harmful ingress of water, IP degree in accordance with IEC 60529 (IEC 60335-2-40)		--
	- appliances or parts intended for outdoor use be at least IPX4 (IEC 60335-2-40);	Outdoor unit: IP24	P
	- appliances intended only for indoor use (excluding laundry rooms) be IPX0 (IEC 60335-2-40);	Indoor unit: IPX0	P

IEC 60335-2-40			
Clause	Requirement + Test	Result - Remark	Verdict
	- appliances intended to be used in laundry rooms be at least IPX1 (IEC 60335-2-40).		N/A
6.101	Degree of accessibility (accessible/not accessible to the general public) (IEC 60335-2-40)	Accessible to the general public	P
7	MARKING AND INSTRUCTIONS		--
7.1	Rated voltage or voltage range (V) .....	220 V – 240 V	P
	Symbol for nature of supply including number of phases, unless for single phase operation (IEC 60335-2-40) .....		N/A
	Rated frequency (Hz) .....	50 Hz	P
	Rated power input (W), or .....	See page 2	P
	Rated current (A) .....	See page 2	P
	Manufacturer's or responsible vendor's name, trademark or identification mark .....	<b>Midea</b>	P
	Model or type reference.....	See page 2	P
	Symbol IEC 60417-5172, for class II appliances		N/A
	IP number, other than IPX0 .....	Outdoor unit: IP24	P
	Symbol IEC 60417-5180, for class III appliances, unless		N/A
	the appliance is operated by batteries only		N/A
	Symbol IEC 60417-5036, for the enclosure of electrically-operated water valves in external hose-sets for connection of an appliance to the water mains, if the working voltage exceeds extra-low voltage		N/A
	Mass of refrigerant or of each refrigerant in blend (except for azeotropic type) (IEC 60335-2-40) .....	See marking plate	P
	Refrigerant identification (IEC 60335-2-40) .....	R32	P
	Permissible excessive operating pressure for sanitary hot water heat pumps (IEC 60335-2-40) :		N/A
	Maximum operating pressure for heat exchanger for hydronic fan coil/air handling units (IEC 60335-2-40/A2) .....		N/A
	Permissible excessive operating pressure of refrigerant circuit for suction and discharge, if they differ (IEC 60335-2-40) .....	4,4 MPa	P
	Symbol for degree of protection against ingress of water, other than IPX0 (IEC 60335-2-40) .....	Outdoor unit: IP24	P
	Separate marking of appliances with all rated characteristics of supplementary heaters (IEC 60335-2-40) .....		N/A
	Marking of direction of fluid flow (IEC 60335-2-40)		N/A

IEC 60335-2-40			
Clause	Requirement + Test	Result - Remark	Verdict
	Flame symbol and instruction manual symbol of 7.6 visible when flammable refrigerant employed and following conditions exist (IEC 60335-2-40/A1):		--
	- accessing parts expected to be subjected to maintenance or repair (IEC 60335-2-40/A1);		P
	- observing appliance under sale or installed conditions (IEC 60335-2-40/A1);		P
	- observing appliance packaging, if appliance charged with refrigerant (IEC 60335-2-40/A1).		P
	If flammable refrigerant used, symbols for "read operator's manual", "operator's manual; operating instructions" and "service indicator; read technical manual" (symbols 0790, 1641 and 1659 of ISO 7000) placed on appliance in location visible to persons required to know information. Perpendicular height be at least 10 mm (IEC 60335-2-40/A1 corr.1)		P
	Additional warning symbol (flame symbol: B.3.2 of ISO 3864) placed on nameplate of unit near declaration of refrigerant type and charge information. Perpendicular height be at least 10 mm, and symbol need not be in colour (IEC 60335-2-40/A1)		P
	Following warning also applied to appliance when flammable refrigerant employed.  WARNING Appliance shall be installed, operated and stored in a room with a floor area larger than 'X' m <sup>2</sup> (only applies to appliances that are not fixed appliances) (IEC 60335-2-40/A1)		N/A
	Not fixed appliances, minimum room size X specified on appliance. X in marking determined in m <sup>2</sup> by procedure described in paragraph 2 of annex GG for unventilated areas and X in marking be 4 if refrigerant charge of appliance is less than m <sub>1</sub> (see annex GG, paragraph 1.1) (IEC 60335-2-40/A1)		N/A
	Maximum allowable pressure for low-pressure side and high-pressure side marked on product (IEC 60335-2-40/A1)		P
	If not already visible when accessing service port and if service port provided, service port marked to identify type of refrigerant. If refrigerant is flammable, symbol B.3.2 of ISO 3864, be included, without specifying the colour (IEC 60335-2-40/A1)		P
7.2	Warning for stationary appliances for multiple supply		N/A
	Warning placed in vicinity of terminal cover		N/A

IEC 60335-2-40			
Clause	Requirement + Test	Result - Remark	Verdict
7.3	Range of rated values marked with the lower and upper limits separated by a hyphen		P
	Different rated values marked with the values separated by an oblique stroke		N/A
7.4	Appliances adjustable for different rated voltages, the voltage setting is clearly discernible		N/A
	Requirement met if frequent changes are not required and the rated voltage to which the appliance is to be adjusted is determined from a wiring diagram		N/A
7.5	Appliances with more than one rated voltage or one or more rated voltage ranges, marked with rated input or rated current for each rated voltage or range, unless		N/A
	the power input is related to the arithmetic mean value of the rated voltage range		P
	Relation between marking for upper and lower limits of rated power input or rated current and voltage is clear		N/A
7.6	Correct symbols used		P
	Flammable refrigerant, warning symbol B.3.2 of ISO 3864, including colour and format, permanently placed on appliance. Perpendicular height of triangle containing "Caution, risk of fire" symbol be at least 30 mm (IEC 60335-2-40/A1)	Measure: 30 mm	P
	Flammable refrigerant, symbol requiring reference to manual [0790 of ISO 7000], including colour and format, permanently placed on appliance (IEC 60335-2-40/A1 corr.1)		P
	Symbol for nature of supply placed next to rated voltage		P
	Symbol for class II appliances placed unlikely to be confused with other marking		N/A
	Units of physical quantities and their symbols according to international standardized system		P
7.7	Connection diagram fixed to appliances to be connected to more than two supply conductors and appliances for multiple supply, unless		N/A
	correct mode of connection is obvious		N/A
7.8	Except for type Z attachment, terminals for connection to the supply mains indicated as follows:		--
	- marking of terminals exclusively for the neutral conductor (letter N)		N/A

IEC 60335-2-40			
Clause	Requirement + Test	Result - Remark	Verdict
	- marking of protective earthing terminals (symbol IEC 60417-5019)		P
	- marking not placed on removable parts		P
7.9	Marking or placing of switches which may cause a hazard		N/A
7.10	Indications of switches on stationary appliances and controls on all appliances by use of figures, letters or other visual means .....		P
	This applies also to switches which are part of a control		P
	If figures are used, the off position indicated by the figure 0		N/A
	The figure 0 indicates only OFF position, unless no confusion with the OFF position		N/A
7.11	Indication for direction of adjustment of controls		N/A
7.12	Instructions for safe use provided		P
	Details concerning precautions during user maintenance		P
	Appliances not accessible to general public, classification of clause 6.101 included (IEC 60335-2-40)		N/A
	Appliances using flammable refrigerants, an installation, service and operation manual, either separate or combined manuals, provided and include information given in annex DD (IEC 60335-2-40/A1)		P
	The instructions state that:		--
	- the appliance is not to be used by persons (including children) with reduced physical, sensory or mental capabilities, or lack of experience and knowledge, unless they have been given supervision or instruction		P
	- children being supervised not to play with the appliance		P
	For a part of class III construction supplied from a detachable power supply unit, the instructions state that the appliance is only to be used with the unit provided		N/A
	Instructions for class III appliances state that it must only be supplied at SELV, unless		N/A
	it is a battery-operated appliance, the battery being charged outside the appliance		N/A
7.12.1	Sufficient details for installation supplied		P

IEC 60335-2-40			
Clause	Requirement + Test	Result - Remark	Verdict
	For an appliance intended to be permanently connected to the water mains and not connected by a hose-set, this is stated		N/A
	Sufficient details for installation or maintenance supplied (IEC 60335-2-40):		--
	- that the appliance shall be installed in accordance with national wiring regulations (IEC 60335-2-40);		P
	- the dimensions of the space necessary for correct installation of the appliance including the minimum permissible distance to adjacent structures (IEC 60335-2-40);		P
	- for appliances with supplementary heaters, the minimum clearance from the appliance to combustible surfaces (IEC 60335-2-40);		N/A
	- a wiring diagram with a clear indication of the connections and wiring to external control devices and supply cord (IEC 60335-2-40);		P
	- the range of external static pressures at which the appliance was tested (add-on heat pumps and appliances with supplementary heaters only) (IEC 60335-2-40);		N/A
	- the method of connection to the appliance to the electrical supply and interconnection of separate components (IEC 60335-2-40);		P
	- indication of which parts of the appliance are suitable for outdoor use, if applicable (IEC 60335-2-40);		P
	- details of type and rating of fuses (IEC 60335-2-40);		P
	- details of supplementary heating elements that may be used in conjunction with the appliance, including fitting instructions either with the appliance or with the supplementary heater (IEC 60335-2-40);		N/A
	- maximum and minimum water or brine operating temperatures (IEC 60335-2-40);		N/A
	- maximum and minimum water or brine operating pressures (IEC 60335-2-40).		N/A
	Open storage tanks of heat pumps for water heating, accompanied by an instruction sheet which state that the vent shall not be obstructed (IEC 60335-2-40)		N/A
7.12.2	Stationary appliances not fitted with means for disconnection from the supply mains having a contact separation in all poles that provide full disconnection under overvoltage category III, the instructions state that means for disconnection must be incorporated in the fixed wiring in accordance with the wiring rules		P

IEC 60335-2-40			
Clause	Requirement + Test	Result - Remark	Verdict
7.12.3	Insulation of the fixed wiring in contact with parts exceeding 50 K during clause 11; instructions state that the fixed wiring must be protected		N/A
7.12.4	Instructions for built-in appliances:		--
	- dimensions of space		N/A
	- dimensions and position of supporting and fixing		N/A
	- minimum distances between parts and surrounding structure		N/A
	- minimum dimensions of ventilating openings and arrangement		N/A
	- connection to supply mains and interconnection of separate components		N/A
	- allow disconnection of the appliance after installation, by accessible plug or a switch in the fixed wiring, unless		N/A
	a switch complying with 24.3		N/A
7.12.5	Replacement cord instructions, type X attachment with a specially prepared cord		N/A
	Replacement cord instructions, type Y attachment		N/A
	Replacement cord instructions, type Z attachment		N/A
7.12.6	Caution in the instructions for appliances incorporating a non-self-resetting thermal cut-out that is reset by disconnection of the supply mains, if this cut-out is required to comply with the standard		N/A
7.12.7	Instructions for fixed appliances stating how the appliance is to be fixed		P
7.12.8	Instructions for appliances connected to the water mains:		--
	- max. inlet water pressure (Pa) ..... :		N/A
	- min. inlet water pressure, if necessary (Pa) ..... :		N/A
	Instructions concerning new and old hose-sets for appliances connected to the water mains by detachable hose-sets		N/A
7.13	Instructions and other texts in an official language	English	P
7.14	Marking clearly legible and durable, rubbing test as specified		P
7.15	Markings on a main part		P
	Marking clearly discernible from the outside, if necessary after removal of a cover		P
	For portable appliances, cover can be removed or opened without a tool		N/A
	For stationary appliances, name, trademark or identification mark and model or type reference visible after installation		P

IEC 60335-2-40			
Clause	Requirement + Test	Result - Remark	Verdict
	For fixed appliances, name, trademark or identification mark and model or type reference visible after installation according to the instructions		P
	Indications for switches and controls placed on or near the components. Marking not on parts which can be positioned or repositioned in such a way that the marking is misleading		P
	Marking on panel allowed, provided panel in place for intended operation of appliance (IEC 60335-2-40)		N/A
7.16	Marking of a possible replaceable thermal link or fuse link clearly visible with regard to replacing the link		N/A
7.101	Marking of fuses and overload protective devices, if replaceable (IEC 60335-2-40):		--
	- fuse rated current in amperes, type and rated voltage or (IEC 60335-2-40)		N/A
	- manufacturer and model of overload protective device (IEC 60335-2-40)		N/A
7.102	Marking for connection with aluminium wire, if necessary (IEC 60335-2-40)		N/A
8	PROTECTION AGAINST ACCESS TO LIVE PARTS		--
8.1	Adequate protection against accidental contact with live parts		P
8.1.1	Requirement applies for all positions, detachable parts removed		P
	Lamps behind a detachable cover not removed, if conditions met		N/A
	Insertion or removal of lamps, protection against contact with live parts of the lamp cap		N/A
	Use of test probe B of IEC 61032, with a force not exceeding 1 N: no contact with live parts		P
	Use of test probe B of IEC 61032 through openings, with a force of 20 N: no contact with live parts		P
8.1.2	Use of test probe 13 of IEC 61032, with a force not exceeding 1 N, through openings in class 0 appliances and class II appliances/constructions: no contact with live parts		P
	Test probe 13 also applied through openings in earthed metal enclosures having a non-conductive coating: no contact with live parts		P
8.1.3	For appliances other than class II, use of test probe 41 of IEC 61032, with a force not exceeding 1 N: no contact with live parts of visible glowing heating elements		N/A
8.1.4	Accessible part not considered live if:		--

IEC 60335-2-40			
Clause	Requirement + Test	Result - Remark	Verdict
	- safety extra-low a.c. voltage: peak value not exceeding 42,4 V		N/A
	- safety extra-low d.c. voltage: not exceeding 42,4 V		N/A
	- or separated from live parts by protective impedance		N/A
	If protective impedance: d.c. current not exceeding 2 mA, and	Approved anion generator	P
	a.c. peak value not exceeding 0,7 mA		N/A
	- for peak values over 42,4 V up to and including 450 V, capacitance not exceeding 0,1 $\mu$ F		N/A
	- for peak values over 450 V up to and including 15 kV, discharge not exceeding 45 $\mu$ C		N/A
	- for peak values over 15kV, the energy in the discharge not exceeding 350 mJ		N/A
8.1.5	Live parts protected at least by basic insulation before installation or assembly:		--
	- built-in appliances		N/A
	- fixed appliances		P
	- appliances delivered in separate units		P
8.2	Class II appliances and constructions constructed so that there is adequate protection against accidental contact with basic insulation and metal parts separated from live parts by basic insulation only		P
	Only possible to touch parts separated from live parts by double or reinforced insulation		P
9	STARTING OF MOTOR-OPERATED APPLIANCES		--
	Requirements and tests are specified in part 2 when necessary		N/A
10	POWER INPUT AND CURRENT		--
10.1	Power input at normal operating temperature, rated voltage and normal operation not deviating from rated power input by more than shown in table 1. :	(see appended table)	P
	Test carried out at upper and lower limits of the ranges for appliances with one or more rated voltage ranges, unless		N/A
	the rated power input is related to the arithmetic mean value		P
10.2	Current at normal operating temperature, rated voltage and normal operation not deviating from rated current by more than shown in table 2..... :	(see appended table)	P
	Test carried out at upper and lower limits of the ranges for appliances with one or more rated voltage ranges, unless		N/A

IEC 60335-2-40			
Clause	Requirement + Test	Result - Remark	Verdict
	the rated current is related to the arithmetic mean value of the range		P
11	HEATING		--
11.1	No excessive temperatures in normal use (IEC 60335-2-40)		P
	Compliance is checked by the tests of annex C, if (IEC 60335-2-40):		--
	- temperature of motor winding exceeds values shown in table 3 (IEC 60335-2-40)		N/A
	- there is doubt about classification of insulation system of the motor (IEC 60335-2-40)		N/A
11.2	Placing and mounting of appliance (IEC/EN 60335-2-40):		--
	- clearances to adjacent surfaces (IEC 60335-2-40);		P
	- flow rates for liquid source or sink equipment be minimum, except for fan coils where flow rates and liquid temperatures be maximum (IEC 60335-2-40/A2);		N/A
	- static pressures (IEC 60335-2-40);		N/A
	- means of adjusting the flow, flow for tests be minimum obtainable (IEC 60335-2-40);		P
	- adjustable limit controls set at maximum cut-out setting and minimum differential (IEC 60335-2-40).		P
	Appliances with supplementary heaters, use test casing of clause 11.9 (IEC 60335-2-40)		N/A
11.2.1	Appliances with supplementary heaters, inlet duct connected to inlet air opening (IEC 60335-2-40)		N/A
11.2.2	Appliance without supplementary heaters, air outlet used (IEC 60335-2-40)		N/A
11.3	Temperature rise determine by thermocouples or resistance method (IEC 60335-2-40)		P
11.4	Test performed at supply voltage between 0,94 and 1,06 times the rated voltage (IEC 60335-2-40)	1,06 x 240 V= 254,4 V	P
	Heating elements energized at voltage which gives an electrical input of 1,15 times maximum rated power input (IEC 60335-2-40)		N/A
11.5	Test conducted in heating mode and cooling mode, if both exist (IEC 60335-2-40)		P
	All supplementary heating elements operative simultaneously (IEC 60335-2-40)		N/A
11.6	Defrost test in most unfavourable conditions, if needed (IEC/EN 60335-2-40)		N/A
11.7	Appliances operated continuously until steady conditions except for defrost tests (IEC 60335-2-40)		P

<b>IEC 60335-2-40</b>			
Clause	Requirement + Test	Result - Remark	Verdict
11.8	Temperatures not exceeding values of table 3 (IEC 60335-2-40/A2)	(See appended tables)	P
	Protective devices do not operate (IEC 60335-2-40)		P
	Sealing compound not flowing out (IEC 60335-2-40)		P
	Temperature of air in outlet duct not exceed 90 °C (IEC 60335-2-40)		N/A
11.9	Test casing and installation of appliances in accordance with manufacturer's instructions (IEC 60335-2-40)		N/A
	Glass fibre insulation for appliances without indication of minimum clearances according to manufacturer; thermocouple in contact with enclosure (IEC 60335-2-40)		N/A
13	<b>LEAKAGE CURRENT AND ELECTRIC STRENGTH AT OPERATING TEMPERATURE</b>		--
13.1	Leakage current not excessive and electric strength adequate		P
	Heating appliances operated at 1,15 times the rated power input (W) .....		N/A
	Motor-operated appliances and combined appliances supplied at 1,06 times the rated voltage (V) .....	1,06 x 240 V= 254,4 V	P
	Protective impedance and radio interference filters disconnected before carrying out the tests		P
13.2	For class 0, class II and class III appliances, leakage current measured by means of the circuit described in figure 4 of IEC 60990		N/A
	For other appliances, a low impedance ammeter may be used		P
	Leakage current measurements..... (IEC 60335-2-40)	(see appended table)	P
13.3	The appliance is disconnected from the supply		P
	Electric strength tests according to table 4.....	(see appended table)	P
	No breakdown during the tests		P
14	<b>TRANSIENT OVERVOLTAGES</b>		--
	Appliances withstand the transient over-voltages to which they may be subjected		N/A
	Clearances having a value less than specified in table 16 subjected to an impulse voltage test, the test voltage specified in table 6 .....		N/A
	No flashover during the test, unless		N/A
	of functional insulation if the appliance complies with clause 19 with the clearance short-circuited		N/A

<b>IEC 60335-2-40</b>			
Clause	Requirement + Test	Result - Remark	Verdict
15	<b>MOISTURE RESISTANCE</b>		--
15.1	Enclosure provides degree of moisture protection against ingress of water (rain, overflow from drain pan or defrosting), tests of clause 15.2, 15.3, 11.6 and 16) (IEC 60335-2-40)		P
	Motor-compressor not operated and detachable parts removed during tests of clause 15.2 and 15.3 (IEC 60335-2-40/A2)		P
15.2	Tests in accordance with IEC 60529 in appliances other than IPX0, as specified (IEC 60335-2-40)... :	IP24 for outdoor unit	P
15.3	Drain pan filled to brim and subjected to continuous overflow and fan(s) switched on (IEC 60335-2-40)		P
15.101	Spillage test as specified (IEC 60335-2-40/A2)		N/A
	After spillage completed, appliance withstand test of clause 16 (IEC 60335-2-40/A2)		N/A
16	<b>LEAKAGE CURRENT AND ELECTRIC STRENGTH</b>		--
16.1	Leakage current not excessive and electric strength adequate		P
	Protective impedance disconnected from live parts before carrying out the tests		N/A
	Tests carried out at room temperature and not connected to the supply		P
16.2	Single-phase appliances: test voltage 1,06 times rated voltage (V) ..... :	1,06 x 240 V= 254,4 V	P
	Three-phase appliances: test voltage 1,06 times rated voltage divided by $\sqrt{3}$ (V)..... :		P
	Leakage current measurements..... : (IEC 60335-2-40)	(see appended table)	P
	Limit values doubled if:		--
	- all controls have an off position in all poles, or		N/A
	- the appliance has no control other than a thermal cut-out, or		N/A
	- all thermostats, temperature limiters and energy regulators do not have an off position, or		N/A
	- the appliance has radio interference filters		N/A
	With the radio interference filters disconnected, the leakage current do not exceed limits specified..... :		N/A
16.3	Electric strength tests according to table 7..... :	(see appended table)	P
	Test voltage applied between the supply cord and inlet bushing and cord guard and cord anchorage as specified..... :		N/A
	No breakdown during the tests		P
17	<b>OVERLOAD PROTECTION OF TRANSFORMERS AND ASSOCIATED CIRCUITS</b>		--

IEC 60335-2-40			
Clause	Requirement + Test	Result - Remark	Verdict
	No excessive temperatures in transformer or associated circuits in event of short-circuits likely to occur in normal use .....	(see appended table)	P
	Appliance supplied with 1,06 or 0,94 times rated voltage under the most unfavourable short-circuit or overload likely to occur in normal use (V) .....	1,06 x 240 V= 254,4 V	P
	Basic insulation is not short-circuited		P
	Temperature rise of insulation of the conductors of safety extra-low voltage circuits not exceeding the relevant value specified in table 3 by more than 15 K		N/A
	Temperature of the winding not exceeding the value specified in table 8		P
	However, limits do not apply to fail-safe transformers complying with sub-clause 15.5 of IEC 61558-1		N/A
18	ENDURANCE		--
	Requirements and tests are specified in part 2 when necessary		N/A
19	ABNORMAL OPERATION		--
19.1	The risk of fire or mechanical damage under abnormal or careless operation obviated (tests 19.2-19.14) (IEC 60335-2-40)		P
	Failure of transfer medium flow or of any control device not result in a hazard (IEC 60335-2-40)		P
	Electronic circuits so designed and applied that a fault will not render the appliance unsafe (electric shock, fire or mechanical hazard, dangerous malfunction) (test 19.11 and 19.12) (IEC 60335-2-40)		P
19.2	Test of appliance with motor rotors, other than motor-compressors, operated for 15 days (360 h) or until protection device opens circuit (IEC 60335-2-40)		P
	Insulation of motor windings (IEC 60335-2-40) .... :		P
	Temperature of enclosure does not exceed (°C) (IEC 60335-2-40) .....		P
	Temperature of the windings does not exceed the values shown in the table; temperature (°C) (IEC 60335-2-40) .....		P
	Electric strength test as specified in 16.3, 72 h after the beginning of the test (IEC 60335-2-40)		P
	30 mA residual current device does not open (IEC 60335-2-40)		P

<b>IEC 60335-2-40</b>			
Clause	Requirement + Test	Result - Remark	Verdict
	At the end, leakage current between windings and enclosure does not exceed 2 mA (IEC 60335-2-40)		P
19.3	Motor-compressor complies with IEC 60335-2-34 (IEC 60335-2-40)		N/A
	Test of motor-compressor with rotor locked as specified in clause 19.101 of IEC 60335-2-34 and comply with 19.104 of that standard (IEC 60335-2-40)		P
19.4	Test of three-phase motors operated under conditions of clause 11 with one phase disconnected until steady conditions or protective device operates (IEC 60335-2-40)		N/A
19.5	Test of appliance with heat transfer medium flow of the outdoor heat exchanger restricted or shut off when reaching steady conditions (IEC 60335-2-40)		P
	Test of appliance with heat transfer flow of the indoor heat exchanger restricted or shut off when reaching steady conditions (IEC 60335-2-40)		P
	Disconnection of motor common to both the outdoor and the indoor heat exchangers when reaching steady conditions (IEC 60335-2-40)		N/A
19.6	Test of appliances using water as heat transfer medium (IEC 60335-2-40)		N/A
19.7	Test of air to air appliances at rated voltage or at the upper limit of the rated voltage range. Dry-bulb temperature is 5 K below values specified by manufacturer (IEC 60335-2-40)		P
	Test with the dry-bulb temperature 10 K over the values specified by manufacturer (IEC 60335-2-40)		P
19.8	Test of appliances with supplementary heaters (IEC 60335-2-40)		N/A
19.9	Test at temperature permitting continuous operation of the motor-compressor and electric heating elements at same time (IEC 60335-2-40)		N/A
19.10	Test of appliance with any defect which expected during normal use (IEC 60335-2-40)	(see appended table)	P
19.10.101	Test of clause 19.10 repeated on class 0I appliances and class I appliances incorporating tubular sheathed or embedded heating elements (IEC 60335-2-40/A2)		N/A
	However, controls not short-circuited but one end of element connected to sheath of heating element (IEC 60335-2-40/A2)		N/A
	Test repeated with polarity of supply to appliance reversed and with other end of element connected to sheath (IEC 60335-2-40/A2)		N/A

IEC 60335-2-40			
Clause	Requirement + Test	Result - Remark	Verdict
	Test not carried out on appliances intended to permanently connected to fixed wiring and on appliances where an all-pole disconnection occurs during test of clause 19.10 (IEC 60335-2-40/A2)		N/A
19.11	Electronic circuits, compliance checked by evaluation of the fault conditions specified in clause 19.11.2 for all circuits or parts of circuits (IEC 60335-2-40), unless		P
	they comply with conditions specified in clause 19.11.1 (IEC 60335-2-40)		P
	Windings temperature not exceeding values shown in table 8 (IEC 60335-2-40)		P
	Appliance comply with conditions of clause 19.14 (IEC 60335-2-40)		P
	Appliance withstands test: a conductor becomes open circuited and three conditions are met (IEC 60335-2-40)		N/A
19.11.1	Before applying the fault conditions a) to f) in 19.11.2, it is checked if circuits or parts of circuit meet both of following conditions (IEC 60335-2-40):		--
	- electronic circuit is low-power circuit, that is, maximum power at low-power points not exceed 15 W according to tests specified (IEC 60335-2-40)		P
	- protection against electric shock, fire hazard, mechanical hazard or dangerous malfunction in other parts of appliance does not rely on correct functioning of electronic circuit (IEC 60335-2-40)		P
19.11.2	Fault conditions applied one at a time, appliance operated under conditions specified in clause 11, but supplied at rated voltage, duration of tests as specified (IEC 60335-2-40):		--
	a) short circuit of creepage distances and clearances between live parts of different potential, if these distances less than values specified in clause 29.1, unless relevant part is adequately encapsulated (IEC 60335-2-40)		N/A
	b) open circuit at terminals of any component (IEC 60335-2-40)		P
	c) short circuit if capacitors, unless they comply with IEC 60384-14 (IEC 60335-2-40)		P
	d) short circuit of any two terminals of an electronic component, other than integrated circuits. This fault condition not applied between circuits of an optocoupler (IEC 60335-2-40)		P
	e) failure of triacs in diode mode (IEC 60335-2-40)		N/A

IEC 60335-2-40			
Clause	Requirement + Test	Result - Remark	Verdict
	f) failure of an integrated circuit. Possible hazardous situations of appliance assessed to ensure that safety not rely on correct functioning of such component (IEC 60335-2-40)		P
	Short-circuit of low-power circuits (IEC 60335-2-40)		P
	Duration of tests (IEC 60335-2-40):		--
	- as specified in clause 11.7 but only for one operating cycle, if fault cannot recognised by user (IEC 60335-2-40);		N/A
	- as specified in clause 19.2, if fault can recognised by user (IEC 60335-2-40);		N/A
	- until steady conditions established (IEC 60335-2-40).		P
	Test ended if interruption of supply occurs within the appliance (IEC 60335-2-40)		P
	If electronic circuit operates to ensure compliance with clause 19, relevant test repeated with single fault a) to f) simulated (IEC 60335-2-40)		N/A
	Fault condition f) applied to encapsulated or similar components (IEC 60335-2-40)		N/A
	PTC's, NTC's and VDR's resistors not short-circuited if used as specified by manufacturer (IEC 60335-2-40)		P
19.12	If safety of appliance for any of fault conditions specified in clause 19.11.2 depends on operation of miniature fuse-link complying with IEC 60127, test repeated with fuse-link replaced by an ammeter (IEC 60335-2-40)		P
	Current $\leq 2,1$ times rated current of fuse-link, circuit not adequately protected (fuse-link short-circuited) (IEC 60335-2-40)		N/A
	Current $\geq 2,75$ times rated current of fuse-link, circuit adequately protected (IEC 60335-2-40)		P
	Current $\geq 2,1$ and $\leq 2,75$ times rated current, fuse-link short-circuited and test carried out during specified time (IEC 60335-2-40)		N/A
19.13	Appliances with PTC heating elements test as specified (IEC 60335-2-40)		N/A
19.14	During tests of clause 19.2 to 19.10.101 and 19.11, 19.12 and 19.13 if appropriate, appliances not emit flames, molten metal, poisonous or ignitable gas in hazardous amounts (IEC 60335-2-40/A2)		P
	Enclosures not deform (IEC 60335-2-40)		P
	Temperature rise not exceed values shown in table 9 (IEC 60335-2-40)	(See appended table)	P

IEC 60335-2-40			
Clause	Requirement + Test	Result - Remark	Verdict
	Electric strength test, test voltage as specified in table 4 (IEC 60335-2-40)		P
19.15	For appliances with a mains voltage selector switch, the switch is set to the lowest rated voltage position and the highest value of rated voltage is applied		N/A
19.101	All appliances provided with supplementary heaters and free air discharge subjected to specified test in each mode of operation (IEC 60335-2-40/A2)		N/A
	During test temperature not exceed 150 °C but an overshoot of 25 °C is permitted during first hour (IEC 60335-2-40/A2)		N/A
20	STABILITY AND MECHANICAL HAZARDS		--
20.1	Appliances having adequate stability	Fixed appliance	N/A
	Tilting test through an angle of 10°, appliance placed on an inclined plane/horizontal support, not connected to the supply mains; appliance does not overturn		N/A
	Tilting test repeated on appliances with heating elements, angle of inclination increased to 15°		N/A
	Possible heating test in overturned position; temperature rise does not exceed values shown in table 9		N/A
20.2	Moving parts adequately arranged or enclosed as to provide protection against personal injury		P
	Protective enclosures, guards and similar parts are non-detachable, and		P
	have adequate mechanical strength		P
	Enclosures that can be opened by overriding an interlock are considered to be detachable parts		N/A
	Self-resetting thermal cut-outs and overcurrent protective devices not causing a hazard by unexpected closure		P
	Not possible to touch dangerous moving parts with the test probe described		P
21	MECHANICAL STRENGTH		--
21.1	Appliance has adequate mechanical strength and is constructed as to withstand rough handling		P
	Checked by applying 3 blows to every point of the enclosure like to be weak, in accordance with test Ehb of IEC 60068-2-75, spring hammer test, with an impact energy of 0,5 J	(see appended table)	P
	The appliance shows no damage impairing compliance with this standard, and		P

IEC 60335-2-40			
Clause	Requirement + Test	Result - Remark	Verdict
	compliance with 8.1, 15.1 and clause 29 not impaired		P
	If doubt, supplementary or reinforced insulation subjected to the electric strength test of 16.3		N/A
	If necessary, repetition of groups of three blows on a new sample		N/A
	Safety requirements specified in annex EE applied. Pressure test in annex EE applies to parts other than pressure vessels (IEC 60335-2-40/A1)		P
	Safety requirements of ISO 5149 applied (IEC 60335-2-40/A2)		P
21.2	Accessible parts of solid insulation having strength to prevent penetration by sharp implements		P
	Test not applicable if the thickness of supplementary insulation is at least 1 mm and reinforced insulation at least 2 mm		P
	The insulation is tested as specified, and does withstand the electric strength test of 16.3		N/A
22	CONSTRUCTION		--
22.1	Appliance marked with the first numeral of the IP system, relevant requirements of IEC 60529 are fulfilled	Outdoor unit: IP24	P
22.2	Stationary appliance: means to ensure all-pole disconnection from the supply being provided:		--
	- a supply cord fitted with a plug, or		N/A
	- a switch complying with 24.3, or		N/A
	- a statement in the instruction sheet that a disconnection incorporated in the fixed wiring is to be provided, or		P
	- an appliance inlet		N/A
	Single-pole switches and single-pole protective devices for the disconnection of heating elements in single-phase, permanently connected class 01 and class I appliances, connected to the phase conductor		N/A
22.3	Appliance provided with pins: no undue strain on socket-outlets		N/A
	Applied torque not exceeding 0,25 Nm		N/A
	Pull force of 50 N to each pin after the appliance has being placed in the heating cabinet; when cooled to room temperature the pins are not displaced by more than 1 mm		N/A
	Each pin subjected to a torque of 0,4 Nm; the pins are not rotating, unless		N/A

IEC 60335-2-40			
Clause	Requirement + Test	Result - Remark	Verdict
	rotating does not impair compliance with this standard		N/A
22.4	Appliance for heating liquids and appliance causing undue vibration not provided with pins for insertion into socket-outlets		P
22.5	No risk of electric shock when touching the pins of the plug, for appliances having a capacitor with rated capacitance exceeding 0,1 $\mu$ F, the appliance being disconnected from the supply at the instant of voltage peak		N/A
	Voltage not exceeding 34 V (V)..... :		N/A
22.6	Electrical insulation not affected by condensing water or leaking liquid		P
	Electrical insulation of class II appliances not affected if a hose ruptures or seal leaks		P
	In case of doubt, test as described		N/A
	Electrical insulation not affected by snow penetration to appliance enclosure (IEC 60335-2-40)		P
22.7	Adequate safeguards against the risk of excessive pressure in appliances containing liquid or gases or having steam-producing devices		N/A
22.8	Electrical connections not subject to pulling during cleaning of compartments to which access can be gained without the aid of a tool, and that are likely to be cleaned in normal use		P
22.9	Insulation, internal wiring, windings, commutators and slip rings not exposed to oil, grease or similar substances, unless		P
	the substance has adequate insulating properties		N/A
22.10	Not possible to reset voltage-maintained non-self-resetting thermal cut-outs by the operation of an automatic switching device incorporated within the appliance, if:		N/A
	- a non-self-resetting thermal cut-out is required by the standard, and		N/A
	- a voltage maintained non-self-resetting thermal cut-out is used to meet it		N/A
	Non-self-resetting thermal motor protectors have a trip-free action, unless		N/A
	they are voltage maintained		N/A
	Reset buttons of non-self-resetting controls so located or protected that accidental resetting is unlikely		N/A

IEC 60335-2-40			
Clause	Requirement + Test	Result - Remark	Verdict
22.11	Reliable fixing of non-detachable parts that provide the necessary degree of protection against electric shock, moisture or contact with moving parts		P
	Obvious locked position of snap-in devices used for fixing such parts		N/A
	No deterioration of the fixing properties of snap-in devices used in parts that are likely to be removed during installation or servicing		N/A
	Tests as described		P
22.12	Handles, knobs etc. fixed in a reliable manner		P
	Fixing in wrong position of handles, knobs etc. indicating position of switches or similar components not possible		P
	Axial force 15 N applied to parts, the shape being so that an axial pull is unlikely to be applied		P
	Axial force 30 N applied to parts, the shape being so that an axial pull is likely to be applied		P
22.13	Unlikely that handles, when gripped as in normal use, make the operator's hand touch parts having a temperature rise exceeding the value specified for handles which are held for short periods only		N/A
22.14	No ragged or sharp edges creating a hazard for the user in normal use, or during user maintenance		P
	No exposed pointed ends of self-tapping screws or other fasteners, likely to be touched by the user in normal use or during user maintenance		P
22.15	Storage hooks and the like for flexible cords smooth and well rounded		N/A
22.16	Automatic cord reels cause no undue abrasion or damage to the sheath of the flexible cord, no breakage of conductors strands and no undue wear of contacts		N/A
	Cord reel tested with 6000 operations, as specified		N/A
	Electric strength test of 16.3, voltage of 1000 V applied		N/A
22.17	Spacers not removable from the outside by hand or by means of a screwdriver or a spanner		N/A
22.18	Current-carrying parts and other metal parts resistant to corrosion		P
22.19	Driving belts not relied upon to provide the required level of insulation, unless		N/A
	constructed to prevent inappropriate replacement		N/A
22.20	Direct contact between live parts and thermal insulation effectively prevented, unless		N/A

IEC 60335-2-40			
Clause	Requirement + Test	Result - Remark	Verdict
	material used is non-corrosive, non-hygroscopic and non-combustible		N/A
22.21	Wood, cotton, silk, ordinary paper and fibrous or hygroscopic material not used as insulation, unless		P
	impregnated		N/A
	This requirement does not apply to magnesium oxide and mineral ceramic fibres used for the electrical insulation of heating elements		N/A
22.22	Appliances not containing asbestos		P
22.23	Oils containing polychlorinated biphenyl (PCB) not used		P
22.24	Bare heating elements adequately supported to prevent contact with accessible metal parts in case of rupture or sagging (IEC 60335-2-40)		N/A
	Bare heating elements only used with metal enclosures (wood or composite enclosures not allowed) (IEC 60335-2-40)		N/A
22.25	Sagging heating conductors, except in class III appliances or class III constructions that do not contain live parts, cannot come into contact with accessible metal parts		N/A
22.26	For class III constructions the insulation between parts operating at safety extra-low voltage and other live parts complies with the requirements for double or reinforced insulation		N/A
22.27	Parts connected by protective impedance separated by double or reinforced insulation		N/A
22.28	Metal parts of class II appliances conductively connected to gas pipes or in contact with water, separated from live parts by double or reinforced insulation		N/A
22.29	Class II appliances permanently connected to fixed wiring so constructed that the required degree of access to live parts is maintained after installation		N/A
22.30	Parts serving as supplementary or reinforced insulation fixed so that they cannot be removed without being seriously damaged, or		P
	so constructed that they cannot be replaced in an incorrect position, and so that if they are omitted, the appliance is rendered inoperable or manifestly incomplete		N/A
22.31	Neither clearances nor creepage distances over supplementary and reinforced insulation reduced below values specified in clause 29 as a result of wear		P

IEC 60335-2-40			
Clause	Requirement + Test	Result - Remark	Verdict
	Neither clearances nor creepage distances between live parts and accessible parts reduced below values for supplementary insulation if wires, screws etc. become loose		P
22.32	Supplementary and reinforced insulation constructed or protected against pollution so that clearances or creepage distances are not reduced below the values in clause 29		P
	Supplementary insulation of natural or synthetic rubber resistant to ageing, or arranged and dimensioned so that creepage distances are not reduced below values specified in 29.2		N/A
	Ceramic material not tightly sintered, similar materials or beads alone not used as supplementary or reinforced insulation		N/A
	Insulating material in which heating conductors are embedded is considered to be basic insulation, not reinforced insulation		N/A
	Oxygen bomb test at 70 °C for 96 h and 16 h at room temperature		N/A
22.33	Conductive liquids that are or may become accessible in normal use and conductive liquids that are in contact with unearthed accessible metal parts are not in direct contact with live parts		P
	Electrodes not used for heating liquids		N/A
	For class II constructions, conductive liquids that are or may become accessible in normal use and conductive liquids that are in contact with unearthed accessible metal parts, not in direct contact with basic or reinforced insulation, unless		P
	the reinforced insulation consists of at least 3 layers		N/A
	For class II constructions, conductive liquids which are in contact with live parts, not in direct contact with reinforced insulation, unless		N/A
	the reinforced insulation consists of at least 3 layers		N/A
	An air layer not used as basic or supplementary insulation in a double insulation system if likely to be bridged by leaking liquid		P
22.34	Shafts of operating knobs, handles, levers etc. not live, unless		P
	the shaft is not accessible when the part is removed		N/A
22.35	For other than class III constructions, handles, levers and knobs, held or actuated in normal use, not becoming live in the event of a failure of basic insulation		P

IEC 60335-2-40			
Clause	Requirement + Test	Result - Remark	Verdict
	Such parts being of metal, and their shafts or fixings are likely to become live in the event of a failure of basic insulation, are either adequately covered by insulation material or their accessible parts are separated from their shafts or fixings by supplementary insulation		N/A
	This requirement does not apply to handles, levers and knobs on stationary appliances, other than those of electrical components, provided they are reliably connected to an earthing terminal or earthing contact, or separated from live parts by earthed metal		P
	Insulating material covering metal handles, levers and knobs withstand the electric strength test of 16.3 for supplementary insulation		N/A
22.36	For appliances other than class III, handles continuously held in the hand in normal use so constructed that when gripped as in normal use, the operators hand is not likely to touch metal parts, unless		N/A
	they are separated from live parts by double or reinforced insulation		N/A
22.37	Capacitors in class II appliances not connected to accessible metal parts and their casings, if of metal, separated from accessible metal parts by supplementary insulation, unless		N/A
	the capacitors comply with 22.42		N/A
22.38	Capacitors not connected between the contacts of a thermal cut-out		P
22.39	Lamp holders used only for the connection of lamps		N/A
22.40	Motor-operated appliances and combined appliances intended to be moved while in operation, or having accessible moving parts, fitted with a switch to control the motor. The actuating member of the switch being easily visible and accessible		N/A
	If the appliance cannot operate continuously, automatically or remotely without giving rise to a hazard, appliances for remote operation being fitted with a switch for stopping the operation. The actuating member of the switch being easily visible and accessible		N/A
22.41	No components, other than lamps, containing mercury		P
22.42	Protective impedance consisting of at least two separate components	Approved anion generator	P

IEC 60335-2-40			
Clause	Requirement + Test	Result - Remark	Verdict
	Values specified in 8.1.4 not exceeded if any one of the components are short-circuited or open-circuited		P
	Resistors checked by the test of 14.1 a) in IEC 60065		P
	Capacitors checked by the tests for class Y capacitors in IEC 60384-14		N/A
22.43	Appliances adjustable for different voltages, accidental changing of the setting of the voltage unlikely to occur		N/A
22.44	Appliances not having an enclosure that is shaped or decorated like a toy		P
22.45	When air is used as reinforced insulation, clearances not reduced below the values specified in 29.1.3 due to deformation as a result of an external force applied to the enclosure		P
22.46	For programmable protective electronic circuits used to ensure compliance with the standard, the software contains measures to control the fault/error conditions in table R.1		N/A
	Software that contains measures to control the fault/error conditions specified in table R.2 is to be specified in parts 2 for particular constructions or to address specific hazards		N/A
	These requirements are not applicable to software used for functional purpose or compliance with clause 11		N/A
22.47	Appliances connected to the water mains withstand the water pressure expected in normal use		N/A
	No leakage from any part, including any inlet water hose		N/A
22.48	Appliances connected to the water mains constructed to prevent backsiphonage of non-potable water		N/A
22.49	For remote operation, the duration of operation is to be set before the appliance can be started, unless		N/A
	the appliance switches off automatically or can operate continuously without hazard		N/A
22.50	Controls incorporated in the appliance take priority over controls actuated by remote operation		N/A
22.51	There is a control on the appliance manually adjusted to the setting for remote operation before the appliance can be operated in this mode		N/A
	There is a visual indication showing that the appliance is adjusted for remote operation		N/A

IEC 60335-2-40			
Clause	Requirement + Test	Result - Remark	Verdict
	These requirements not necessary on appliances that can operate as follows, without giving rise to a hazard:		--
	- continuously, or		N/A
	- automatically, or		N/A
	- remotely		N/A
22.52	Socket-outlets on appliances accessible to the user in accordance with the socket-outlet system used in the country in which the appliance is sold		N/A
22.101	Appliances intended to be fixed, securely fixed (IEC 60335-2-40)		P
22.102.1	At least two thermal cut-outs in appliances with supplementary heating elements for air (first one be self-resetting and other non-self-resetting thermal cut-out) (IEC 60335-2-40/A2)		N/A
22.102.2	Appliances provided with supplementary heaters for water incorporate non-self-resetting thermal cut-out, providing all-pole disconnection that operates separately from water thermostats (IEC 60335-2-40/A2)		N/A
	However, for appliances intended to be connected to fixed wiring, the neutral conductor need not be disconnected (IEC 60335-2-40/A2)		N/A
22.102.3	Thermal cut-outs of capillary type open in event of leakage from capillary tube (IEC 60335-2-40/A2)		N/A
22.103	Non-self-resetting cut-outs independent of other control devices (IEC 60335-2-40)		N/A
22.104	Containers of sanitary hot water heat pumps withstand twice permissible operating pressure in closed containers (IEC 60335-2-40) or		N/A
	0,15 MPa in open containers (IEC 60335-2-40)		N/A
	without leakage or rupture (IEC 60335-2-40)		N/A
22.105	Air or vapour cushion in closed containers not exceeding 10 % (IEC 60335-2-40)		N/A
22.106	Pressure relief devices operating at 0,1 MPa over permissible operating pressure (IEC 60335-2-40)		N/A
22.107	Water outlet systems of open containers free from obstruction causing over-pressure (IEC 60335-2-40)		N/A
	Vented containers of sanitary hot water heat pumps always open to the atmosphere through appropriate aperture (IEC 60335-2-40)		N/A
22.108	Not vented open containers subjected to test in accordance with clause 22.104 to vacuum of 33 kPa for 15 min (IEC 60335-2-40)		N/A

IEC 60335-2-40			
Clause	Requirement + Test	Result - Remark	Verdict
	Container show no deformation which result in a hazard (IEC 60335-2-40)		N/A
22.109	Replacement of non-self-resetting thermal cut-outs does not damage other connections (IEC 60335-2-40)		N/A
22.110	Non-self-resetting thermal cut-outs operate without short-circuiting live parts of different potential and without causing contact between live parts and enclosure (IEC 60335-2-40)		N/A
	Test repeated five times without blowing 3 A fuse which connects appliance to earth (IEC 60335-2-40)		N/A
	Electric strength test as specified in clause 16.3 for supplementary heating elements (IEC 60335-2-40)		N/A
22.111	Manual resetting of thermostats not necessary after power supply interruption (IEC 60335-2-40)		P
22.112	Construction of refrigerating system comply with requirements of Section 3 of ISO 5149 (IEC 60335-2-40/A1)		P
22.113	Flammable refrigerant used, refrigerant tubing protected or enclosed to avoid mechanical damage (IEC 60335-2-40/A1)		P
	Tubing protected to extent that it will not be handled or used for carrying during moving of product (IEC 60335-2-40/A1)		P
	Tubing located within confines of cabinet considered to be protected from mechanical damage (IEC 60335-2-40/A1)		P
22.114	Flammable refrigerant used, low temperature solder alloys, such as lead/tin alloys, not acceptable for pipe connections (IEC 60335-2-40/A1)		P
22.115	Total refrigerant mass (M) of all refrigerating systems within appliance employing flammable refrigerants, not exceed $m_3$ defined in annex GG (IEC 60335-2-40/A1)		P
22.116	Appliances using flammable refrigerants constructed that any leaked refrigerant not flow or stagnate so as to cause fire or explosion hazard in areas within appliance where electrical components, which could be a source of ignition and which could function under normal conditions or in event of leak, fitted (IEC 60335-2-40/A1)		P
	Separate components, such as thermostats, which charged with less than 0,5 g of flammable gas not considered to cause fire or explosion hazard in event of leakage of gas within component itself (IEC 60335-2-40/A1)		P

IEC 60335-2-40			
Clause	Requirement + Test	Result - Remark	Verdict
	All electrical components that could be a source of ignition and which could function under normal conditions or in the event of a leak, comply with one of the following (IEC 60335-2-40/A1):		--
	- IEC 60079-15:2001, Cl. 9 to 26, for group IIA gases or the refrigerant used or an applicable standard that makes electrical components suitable for use in Zone 2, 1 or 0 as defined in IEC 60079-14 (IEC 60335-2-40/A1)	For relay	P
	- Not be located in an area where a potentially flammable gas mixture will accumulate as demonstrated by the test of annex FF (IEC 60335-2-40/A1)		N/A
	- Be located in an enclosure. The enclosure containing the electrical components comply with IEC 60079-15:2001 for enclosures suitable for use with group IIA gases or the refrigerant used (IEC 60335-2-40/A1)		P
22.117	Temperatures on surfaces that exposed to leakage of flammable refrigerants not exceed auto-ignition temperature of refrigerant reduced by 100 K; some typical values given in annex BB (IEC 60335-2-40/A1)		P
22.118	Flammable refrigerant used, all appliances charged with refrigerant at manufacturing location or charged on site as recommended by manufacturer (IEC 60335-2-40/A1)		P
	Part of appliance that charged on site, which requires brazing or welding in installation not shipped with flammable refrigerant charge. Joints made in installation between parts of refrigerating system, with at least one part charged, made in accordance with following (IEC 60335-2-40/A1):		--
	- A brazed, welded, or mechanical connection shall be made before opening the valves to permit refrigerant to flow between the refrigerating system parts. A vacuum valve shall be provided to evacuate the interconnecting pipe and/or any uncharged refrigerating system part (IEC 60335-2-40/A1)		P
	- Reusable mechanical connectors and flared joints are not allowed indoors (IEC 60335-2-40/A1)		P
	- Refrigerant tubing shall be protected or enclosed to avoid damage (IEC 60335-2-40/A1)		P
	Flexible refrigerant connectors (such as connecting lines between the indoor and outdoor unit) that may be displaced during normal operations shall be protected against mechanical damage (IEC 60335-2-40/A1)		N/A
23	INTERNAL WIRING		--
23.1	Wireways smooth and free from sharp edges		P

IEC 60335-2-40			
Clause	Requirement + Test	Result - Remark	Verdict
	Wires protected against contact with burrs, cooling fins etc.		P
	Wire holes in metal well-rounded or provided with bushings		P
	Wiring effectively prevented from coming into contact with moving parts		P
23.2	Beads etc. on live wires cannot change their position, and are not resting on sharp edges		N/A
	Beads inside flexible metal conduits contained within an insulating sleeve		N/A
23.3	Electrical connections and internal conductors movable relatively to each other not exposed to undue stress		N/A
	Flexible metallic tubes not causing damage to insulation of conductors		N/A
	Open-coil springs not used		N/A
	Adequate insulating lining provided inside a coiled spring, the turns of which touch one another		N/A
	No damage after 10 000 flexings for conductors flexed during normal use, or		N/A
	100 flexings for conductors flexed during user maintenance		N/A
	Electric strength test of 16.3, 1000 V between live parts and accessible metal parts		N/A
	Not more than 10 % of the strands of any conductor broken, and		N/A
	not more than 30 % for wiring supplying circuits that consume no more than 15 W		N/A
23.4	Bare internal wiring sufficiently rigid and fixed		N/A
23.5	The insulation of internal wiring subjected to the supply mains voltage withstanding the electrical stress likely to occur in normal use		P
	Basic insulation electrically equivalent to the basic insulation of cords complying with IEC 60227 or IEC 60245, or		N/A
	no breakdown when a voltage of 2000 V is applied for 15 min between the conductor and metal foil wrapped around the insulation		P
23.6	Sleeving used as supplementary insulation on internal wiring retained in position by clamping at both ends, or		P
	be such that it can only be removed by breaking or cutting		N/A

<b>IEC 60335-2-40</b>			
Clause	Requirement + Test	Result - Remark	Verdict
23.7	The colour combination green/yellow only used for earthing conductors		P
23.8	Aluminium wires not used for internal wiring		P
23.9	Stranded conductors not consolidated by soldering where they are subjected to contact pressure, unless		P
	the contact pressure is provided by spring terminals		N/A
23.10	The insulation and sheath of internal wiring, incorporated in external hoses for the connection of an appliance to the water mains, at least equivalent to that of light polyvinyl chloride sheathed flexible cord (60227 IEC 52)		N/A
24	<b>COMPONENTS</b>		--
24.1	Components comply with safety requirements in relevant IEC standards		P
	List of components ..... :	(see appended table)	P
	If components have not been tested and found to comply with relevant IEC standard for the number of cycles specified, they are tested in accordance with 24.1.1 to 24.1.9		N/A
	For components mentioned in 24.1.1 to 24.1.9 no additional tests specified in the relevant component standard are necessary other than those specified in 24.1.1 to 24.1.9		N/A
	Components not tested and found to comply with relevant IEC standard and components not marked or not used in accordance with its marking, tested under the conditions occurring in the appliance		P
	Lampholders and starterholders that have not being tested and found to comply with the relevant IEC standard, tested as a part of the appliance and additionally according to the gauging and interchangeability requirements of the relevant IEC standard		N/A
	No additional tests specified for nationally standardized plugs such as those detailed in IEC/TR 60083 or connectors complying with the standard sheets of IEC 60320-1 and IEC 60309		N/A
	Motor-compressors not tested according to IEC 60335-2-34 (not necessary to meet all requirements of IEC 60335-2-34) (IEC 60335-2-40)		N/A
24.1.1	Capacitors likely to be permanently subjected to the supply voltage and used for radio interference suppression or for voltage dividing, complying with IEC 60384-14		P
	If the capacitors have to be tested, they are tested according to annex F		N/A

IEC 60335-2-40			
Clause	Requirement + Test	Result - Remark	Verdict
24.1.2	Safety isolating transformers complying with IEC 61558-2-6		N/A
	If they have to be tested, they are tested according to annex G		N/A
24.1.3	Switches complying with IEC 61058-1, the number of cycles of operation being at least 10 000		N/A
	If they have to be tested, they are tested according to annex H		N/A
	If the switch operates a relay or contactor, the complete switching system is subjected to the test		N/A
	If the switch only operates a motor starting relay complying with IEC 60730-2-10 with the number of cycles of a least 10 000 as specified, the complete switching system need not be tested		N/A
24.1.4	Automatic controls complying with IEC 60730-1 with the relevant part 2. The number of cycles of operation being at least:		--
	- thermostats: ..... 10 000		N/A
	- temperature limiters:..... 1 000		N/A
	- self-resetting thermal cut-outs:..... 300		N/A
	- voltage maintained non-self-resetting thermal cut-outs: ..... 1 000		N/A
	- other non-self-resetting thermal cut-outs:..... 30		N/A
	- timers: ..... 3 000		N/A
	- energy regulators:..... 10 000		N/A
	- thermostats which control motor-compressor (IEC/EN 60335-2-40):..... 100 000		N/A
	- motor-compressor starting relays (IEC/EN 60335-2-40):..... 100 000		N/A
	- automatic thermal motor-protectors for hermetic and semi-hermetic type motor-compressors (not less than number of operations during locked rotor test) (IEC/EN 60335-2-40):..... min 2000		N/A
	- manual reset thermal motor-protectors for hermetic and semi-hermetic type motor-compressors (IEC/EN 60335-2-40):..... 50		N/A
	- other automatic thermal motor-protectors (IEC/EN 60335-2-40):..... 2000		N/A
	- other manual reset thermal motor-protectors (IEC/EN 60335-2-40):..... 30		N/A
	The number of cycles for controls operating during clause 11 need not be declared, if the appliance meets the requirements of this standard when they are short-circuited		N/A

IEC 60335-2-40			
Clause	Requirement + Test	Result - Remark	Verdict
	Thermal motor protectors are tested in combination with their motor under the conditions specified in annex D		N/A
	For water valves containing live parts and that are incorporated in external hoses for connection of an appliance to the water mains, the degree of protection declared for subclause 6.5.2 of IEC 60730-2-8 is IPX7		N/A
24.1.5	Appliance couplers complying with IEC 60320-1		N/A
	However, for appliances classified higher than IPX0, the appliance couplers complying with IEC 60320-2-3		N/A
	Interconnection couplers complying with IEC 60320-2-2		N/A
24.1.6	Small lamp holders similar to E10 lampholders complying with IEC 60238, the requirements for E10 lampholders being applicable		N/A
24.1.7	For remote operation of the appliance via a telecommunication network, the relevant standard for the telecommunication interface circuitry in the appliance is IEC 62151		N/A
24.1.8	The relevant standard for thermal links is IEC 60691		P
	Thermal links not complying with IEC 60691 are considered to be an intentionally weak part for the purposes of clause 19		N/A
24.1.9	Contactors and relays, other than motor starting relays, tested as part of the appliance		P
	They are also tested in accordance with clause 17 of IEC 60730-1, the number of cycles of operations in 24.1.4 selected according to the contactor or relay function in the appliance .....		P
24.2	Appliances not fitted with:		--
	- switches or automatic controls in flexible cords		N/A
	- devices causing the protective device in the fixed wiring to operate in the event of a fault in the appliance		P
	- thermal cut-outs that can be reset by soldering, unless		P
	the solder has a melting point of at least 230 °C		N/A
24.3	Switches intended for all-pole disconnection of stationary appliances are directly connected to the supply terminals and have a contact separation in all poles, providing full disconnection under overvoltage category III conditions		N/A

IEC 60335-2-40			
Clause	Requirement + Test	Result - Remark	Verdict
24.4	Plugs and socket-outlets for extra-low voltage circuits and heating elements, not interchangeable with plugs and socket-outlets listed in IEC/TR 60083 or IEC 60906-1 or with connectors and appliance inlets complying with the standard sheets of IEC 60320-1		N/A
24.5	Capacitors in auxiliary windings of motors marked with their rated voltage and capacitance, and used accordingly		N/A
	Voltage across capacitors in series with a motor winding does not exceed 1,1 times rated voltage, when the appliance is supplied at 1,1 times rated voltage under minimum load		N/A
24.6	Working voltage of motors connected to the supply mains and having basic insulation that is inadequate for the rated voltage of the appliance, not exceeding 42 V		N/A
	In addition, the motors comply with the requirements of annex I		N/A
24.7	Detachable hose-sets for connection of appliances to the water mains comply with IEC 61770		N/A
	They are supplied with the appliance		N/A
	Appliances intended to be permanently connected to the water mains not connected by a detachable hose-set		N/A
24.8	Motor running capacitors in appliances for which 30.2.3 is applicable and that are permanently connected in series with a motor winding, not causing a hazard in event of a failure		N/A
	One or more of the following conditions are to be met:		--
	- the capacitors are of class P2 according to IEC 60252-1		N/A
	- the capacitors are housed within a metallic or ceramic enclosure		N/A
	- the distance of separation of the outer surface to adjacent non-metallic parts exceeds 50 mm		N/A
	- adjacent non-metallic parts within 50 mm withstand the needle-flame test of annex E		N/A
	- adjacent non-metallic parts within 50 mm classified as at least V-1 according to IEC 60695-11-10		N/A
24.101	Replaceable parts of thermal control devices identified by marking (IEC 60335-2-40)		N/A
25	SUPPLY CONNECTION AND EXTERNAL FLEXIBLE CORDS		--
25.1	Appliance not intended for permanent connection to fixed wiring, means for connection to the supply:		--

IEC 60335-2-40			
Clause	Requirement + Test	Result - Remark	Verdict
	- supply cord fitted with a plug,		N/A
	- an appliance inlet having at least the same degree of protection against moisture as required for the appliance, or		N/A
	- pins for insertion into socket-outlets		N/A
	Supply cord fitted with plug provided, if (IEC 60335-2-40):		--
	- appliance only for indoor use (IEC 60335-2-40),		N/A
	- marked with rating of 25 A or less and (IEC 60335-2-40)		N/A
	- complies with code requirements of country where it will be used (IEC 60335-2-40).		N/A
	Appliance inlet not allowed (IEC 60335-2-40)		N/A
25.2	Appliance not provided with more than one means of connection to the supply mains		P
	Stationary appliance for multiple supply may be provided with more than one means of connection, provided electric strength test of 1250 V for 1 min between each means of connection causes no breakdown		N/A
25.3	Appliance intended to be permanently connected to fixed wiring provided with one of the following means for connection to the supply mains:		--
	- a set of terminals allowing the connection of a flexible cord		N/A
	- a fitted supply cord		N/A
	- a set of supply leads accommodated in a suitable compartment		N/A
	- a set of terminals for the connection of cables of fixed wiring, cross-sectional areas specified in 26.6, and the appliance allows the connection of the supply conductors after the appliance has been fixed to its support		P
	- a set of terminals and cable entries, conduit entries, knock-outs or glands, allowing connection of appropriate types of cable or conduit, and the appliance allows the connection of the supply conductors after the appliance has been fixed to its support		N/A
	For a fixed appliance constructed so that parts can be removed to facilitate easy installation, this requirement is met if it is possible to connect the fixed wiring without difficulty after a part of the appliance has been fixed to its support		N/A
25.4	Cable and conduit entries, rated current of appliance not exceeding 16 A, dimension according to table 10 (mm) .....		N/A

<b>IEC 60335-2-40</b>			
Clause	Requirement + Test	Result - Remark	Verdict
	Introduction of conduit or cable does not reduce clearances or creepage distances below values specified in clause 29		N/A
25.5	Method for assembling the supply cord to the appliance:		--
	- type X attachment		N/A
	- type Y attachment		N/A
	- type Z attachment, if allowed in relevant part 2		N/A
	Type X attachment, other than those with a specially prepared cord, not used for flat twin tinsel cords		N/A
	For multi-phase appliances supplied with a supply cord and that are intended to be permanently connected to fixed wiring, the supply cord is assembled to the appliance by type Y attachment		N/A
25.6	Plugs fitted with only one flexible cord		N/A
25.7	Supply cords, other than for class III appliances, being one of the following types:		--
	- rubber sheathed (at least 60245 IEC 53)		N/A
	- polychloroprene sheathed (at least 60245 IEC 57)		N/A
	- cross-linked polyvinyl chloride sheathed (at least 60245 IEC 88)		N/A
	- polyvinyl chloride sheathed. Not used if they are likely to touch metal parts having a temperature rise exceeding 75 K during the test of clause 11		--
	- light polyvinyl chloride sheathed cord (60227 IEC 52), for appliances not exceeding 3 kg		N/A
	- ordinary polyvinyl chloride sheathed cord (60227 IEC 53), for other appliances		N/A
	- heat resistant polyvinyl chloride sheathed. Not used for type X attachment other than specially prepared cords		--
	- heat-resistant light polyvinyl chloride sheathed cord (60227 IEC 56), for appliances not exceeding 3 kg		N/A
	- heat-resistant polyvinyl chloride sheathed cord (60227 IEC 57), for other appliances		N/A
	Supply cords for class III appliances adequately insulated		N/A
	Test with 500 V for 2 min for supply cords of class III appliances that contain live parts		N/A
	Supply cords for outdoor use not lighter than polychloroprene sheathed flexible cord (60245 IEC 57) (IEC 60335-2-40)		N/A
25.8	Nominal cross-sectional area of supply cords not less than table 11; rated current (A); cross-sectional area (mm <sup>2</sup> ) .....		N/A

<b>IEC 60335-2-40</b>			
Clause	Requirement + Test	Result - Remark	Verdict
25.9	Supply cords not in contact with sharp points or edges		N/A
25.10	Supply cord of class I appliances have a green/yellow core for earthing		N/A
25.11	Conductors of supply cords not consolidated by soldering where they are subject to contact pressure, unless		N/A
	the contact pressure is provided by spring terminals		N/A
25.12	Insulation of the supply cord not damaged when moulding the cord to part of the enclosure		N/A
25.13	Inlet openings so constructed as to prevent damage to the supply cord		N/A
	If the enclosure at the inlet opening is not of insulating material, a non-detachable lining or bushing complying with 29.3 for supplementary insulation provided		N/A
	If unsheathed supply cord, a similar additional bushing or lining is required, unless the appliance is		N/A
	class 0, or		N/A
	a class III appliance not containing live parts		N/A
25.14	Supply cords moved while in operation adequately protected against excessive flexing		N/A
	Flexing test, as described:		--
	- applied force (N) .....		N/A
	- number of flexings .....		N/A
	The test does not result in:		--
	- short-circuit between the conductors, such that the current exceeds a value of twice the rated current		N/A
	- breakage of more than 10 % of the strands of any conductor		N/A
	- separation of the conductor from its terminal		N/A
	- loosening of any cord guard		N/A
	- damage to the cord or the cord guard		N/A
	- broken strands piercing the insulation and becoming accessible		N/A
25.15	For appliances with supply cord and appliances to be permanently connected to fixed wiring by a flexible cord, conductors of the supply cord relieved from strain, twisting and abrasion by use of cord anchorage		P
	The cord cannot be pushed into the appliance to such an extent that the cord or internal parts of the appliance can be damaged		P

IEC 60335-2-40			
Clause	Requirement + Test	Result - Remark	Verdict
	Pull and torque test of supply cord, values shown in table 12: mass (kg); pull (N); torque (not on automatic cord reel) (Nm)..... :	100 N 0,35 Nm	P
	Cord not damaged and max. 2 mm displacement of the cord	0,2 mm	P
25.16	Cord anchorages for type X attachments constructed and located so that:		--
	- replacement of the cord is easily possible		N/A
	- it is clear how the relief from strain and the prevention of twisting are obtained		N/A
	- they are suitable for different types of supply cord		N/A
	- cord cannot touch the clamping screws of cord anchorage if these screws are accessible, unless		N/A
	they are separated from accessible metal parts by supplementary insulation		N/A
	- the cord is not clamped by a metal screw which bears directly on the cord		N/A
	- at least one part of the cord anchorage securely fixed to the appliance, unless		N/A
	it is part of a specially prepared cord		N/A
	- screws which have to be operated when replacing the cord do not fix any other component, unless		N/A
	the appliance becomes inoperative or incomplete or the parts cannot be removed without a tool		N/A
	- if labyrinths can be bypassed the test of 25.15 is nevertheless withstood		N/A
	- for class 0, 0I and I appliances they are of insulating material or are provided with an insulating lining, unless		N/A
	failure of the insulation of the cord does not make accessible metal parts live		N/A
	- for class II appliances they are of insulating material, or		N/A
	if of metal, they are insulated from accessible metal parts by supplementary insulation		N/A
	After the test of 25.15, under the conditions specified, the conductors have not moved by more than 1 mm in the terminals		N/A
25.17	Adequate cord anchorages for type Y and Z attachment, test with the cord supplied with the appliance		N/A
25.18	Cord anchorages only accessible with the aid of a tool, or		N/A
	Constructed so that the cord can only be fitted with the aid of a tool		N/A

IEC 60335-2-40			
Clause	Requirement + Test	Result - Remark	Verdict
25.19	Type X attachment, glands not used as cord anchorage in portable appliances		N/A
	Tying the cord into a knot or tying the cord with string not used		N/A
25.20	The insulated conductors of the supply cord for type Y and Z attachment additionally insulated from accessible metal parts		N/A
25.21	Space for supply cord for type X attachment or for connection of fixed wiring constructed:		--
	- to permit checking of conductors with respect to correct positioning and connection before fitting any cover		P
	- so there is no risk of damage to the conductors or their insulation when fitting the cover		P
	- for portable appliances, so that the uninsulated end of a conductor, if it becomes free from the terminal, prevented from contact with accessible metal parts		N/A
	2 N test to the conductor for portable appliances; no contact with accessible metal parts		N/A
25.22	Appliance inlets:		--
	- live parts not accessible during insertion or removal		N/A
	Requirement not applicable to appliance inlets complying with IEC 60320-1		N/A
	- connector can be inserted without difficulty		N/A
	- the appliance is not supported by the connector		N/A
	- not for cold conditions if temp. rise of external metal parts exceeds 75 K during clause 11, unless		N/A
	the supply cord is unlikely to touch such metal parts		N/A
25.23	Interconnection cords comply with the requirements for the supply cord, except that:		P
	- the cross-sectional area of the conductors is determined on the basis of the maximum current during clause 11		N/A
	- the thickness of the insulation may be reduced		N/A
	If necessary, electric strength test of 16.3		N/A
25.24	Interconnection cords not detachable without the aid of a tool if compliance with this standard is impaired when they are disconnected		P
25.25	Dimensions of pins that are inserted into socket-outlets compatible with the dimensions of the relevant socket-outlet.		N/A

IEC 60335-2-40			
Clause	Requirement + Test	Result - Remark	Verdict
	Dimensions of pins and engagement face in accordance with the dimensions of the relevant plug in IEC/TR 60083		N/A
26	TERMINALS FOR EXTERNAL CONDUCTORS		--
26.1	Appliances provided with terminals or equally effective devices for connection of external conductors		P
	Terminals only accessible after removal of a non-detachable cover, except		P
	for class III appliances that do not contain live parts		N/A
	Earthing terminals may be accessible if a tool is required to make the connections and means are provided to clamp the wire independently from its connection		N/A
26.2	Appliances with type X attachment and appliances for the connection of cables to fixed wiring provided with terminals in which connections are made by means of screws, nuts or similar devices, unless		P
	the connections are soldered		N/A
	Screws and nuts not used to fix any other component, except		P
	internal conductors, if so arranged that they are unlikely to be displaced when fitting the supply conductors		P
	If soldered connections used, the conductor so positioned or fixed that reliance is not placed on soldering alone, unless		P
	barriers provided so that neither clearances nor creepage distances between live parts and other metal parts reduced below the values for supplementary insulation if the conductor becomes free at the soldered joint		N/A
26.3	Terminals for type X attachment and for connection of cables of fixed wiring so constructed that the conductor is clamped between metal surfaces with sufficient contact pressure but without damaging the conductor		P
	Terminals fixed so that when the clamping means is tightened or loosened:		--
	- the terminal does not become loose		P
	- internal wiring is not subjected to stress		P
	- neither clearances nor creepage distances are reduced below the values in clause 29		P
	Compliance checked by inspection and by the test of subclause 9.6 of IEC 60999-1, the torque applied being equal to two-thirds of the torque specified (Nm)..... :		P

IEC 60335-2-40			
Clause	Requirement + Test	Result - Remark	Verdict
	No deep or sharp indentations of the conductors		N/A
26.4	Terminals for type X attachment, except those having a specially prepared cord and those for the connection of cables of fixed wiring, no special preparation of conductors such as by soldering, use of cable lugs, eyelets or similar, and		P
	so constructed or placed that conductors prevented from slipping out when clamping screws or nuts are tightened		N/A
26.5	Terminals for type X attachment so located or shielded that if a wire of a stranded conductor escapes, no risk of accidental connection to other parts that result in a hazard		N/A
	Stranded conductor test, 8 mm insulation removed		N/A
	No contact between live parts and accessible metal parts and,		N/A
	for class II constructions, between live parts and metal parts separated from accessible metal parts by supplementary insulation only		N/A
26.6	Terminals for type X attachment and for connection of cables of fixed wiring suitable for connection of conductors with cross-sectional area according to table 13; rated current (A); nominal cross-sectional area (mm <sup>2</sup> ) .....	According the state manual	P
	If a specially prepared cord is used, terminals need only be suitable for that cord		N/A
26.7	Terminals for type X attachment, except in class III appliances not containing live parts, accessible after removal of a cover or part of the enclosure		N/A
26.8	Terminals for the connection of fixed wiring, including the earthing terminal, located close to each other		P
26.9	Terminals of the pillar type constructed and located as specified		N/A
26.10	Terminals with screw clamping and screwless terminals not used for flat twin tinsel cords, unless		N/A
	conductors ends fitted with means suitable for screw terminals		N/A
	Pull test of 5 N to the connection		N/A
26.11	For type Y and Z attachment, soldered, welded, crimped or similar connections may be used		N/A
	For class II appliances, the conductor so positioned or fixed that reliance is not placed on soldering, welding or crimping alone		N/A

IEC 60335-2-40			
Clause	Requirement + Test	Result - Remark	Verdict
	If soldering, welding or crimping alone used, barriers provided so that clearances and creepage distances between live parts and other metal parts are not reduced below the values for supplementary insulation if the conductor becomes free		N/A
27	PROVISION FOR EARTHING		--
27.1	Accessible metal parts of class 0I and I appliances permanently and reliably connected to an earthing terminal or earthing contact of the appliance inlet		P
	Earthing terminals and earthing contacts not connected to the neutral terminal		P
	Class 0, II and III appliances have no provision for earthing		N/A
	Safety extra-low voltage circuits not earthed, unless		N/A
	protective extra-low voltage circuits		N/A
27.2	Clamping means of earthing terminals adequately secured against accidental loosening		P
	Terminals for the connection of external equipotential bonding conductors allow connection of conductors of 2,5 to 6 mm <sup>2</sup> , and		N/A
	do not provide earthing continuity between different parts of the appliance, and		N/A
	conductors cannot be loosened without the aid of a tool		N/A
27.3	For a detachable part having an earth connection and being plugged into another part of the appliance, the earth connection is made before and separated after current-carrying connections when removing the part		N/A
	For appliances with supply cords, current-carrying conductors become taut before earthing conductor, if the cord slips out of the cord anchorage		N/A
27.4	No risk of corrosion resulting from contact between parts of the earthing terminal and the copper of the earthing conductor or other metal		P
	Parts providing earthing continuity, other than parts of a metal frame or enclosure, have adequate resistance to corrosion		P
	If of steel, these parts provided with an electroplated coating with a thickness at least 5 µm		N/A
	Adequate protection against rusting of parts of coated or uncoated steel, only intended to provide or transmit contact pressure		P

IEC 60335-2-40			
Clause	Requirement + Test	Result - Remark	Verdict
	In the body of the earthing terminal is a part of a frame or enclosure of aluminium or aluminium alloys, precautions taken to avoid risk of corrosion		P
27.5	Low resistance of connection between earthing terminal and earthed metal parts		P
	This requirement does not apply to connections providing earthing continuity in the protective extra-low voltage circuit, provided the clearances of basic insulation are based on the rated voltage of the appliance		N/A
	Resistance not exceeding 0,1 at the specified low-resistance test ( )..... :	0,05 Ω	P
27.6	The printed conductors of printed circuit boards not used to provide earthing continuity in hand-held appliances.		N/A
	They may be used to provide earthing continuity in other appliances if at least two tracks are used with independent soldering points and the appliance complies with 27.5 for each circuit		N/A
28	SCREWS AND CONNECTIONS		--
28.1	Fixings, electrical connections and connections providing earthing continuity withstand mechanical stresses		P
	Screws not of soft metal liable to creep, such as zinc or aluminium		P
	Diameter of screws of insulating material min. 3 mm		N/A
	Screws of insulating material not used for any electrical connections or connections providing earthing continuity		N/A
	Screws used for electrical connections or connections providing earthing continuity screwed into metal		P
	Screws not of insulating material if their replacement by a metal screw can impair supplementary or reinforced insulation		P
	For type X attachment, screws to be removed for replacement of supply cord or for user maintenance, not of insulating material if their replacement by a metal screw impairs basic insulation		N/A
	For screws and nuts; torque-test as specified in table 14..... :	(see appended table)	P
28.2	Electrical connections and connections providing earthing continuity constructed so that contact pressure is not transmitted through non-ceramic insulating material liable to shrink or distort, unless		P

IEC 60335-2-40			
Clause	Requirement + Test	Result - Remark	Verdict
	there is resiliency in the metallic parts to compensate for shrinkage or distortion of the insulating material		N/A
	This requirement does not apply to electrical connections in circuits of appliances for which:		--
	- 30.2.2 is applicable and that carry a current not exceeding 0,5 A		N/A
	- 30.2.3 is applicable and that carry a current not exceeding 0,2 A		N/A
28.3	Space-threaded (sheet metal) screws only used for electrical connections if they clamp the parts together		P
	Thread-cutting (self-tapping) screws and thread rolling screws only used for electrical connections if they generate a full form standard machine screw thread		N/A
	Thread-cutting (self-tapping) screws not used if they are likely to be operated by the user or installer		N/A
	Thread-cutting, thread rolling and space threaded screws may be used in connections providing earthing continuity provided it is not necessary to disturb the connection:		--
	- in normal use,		P
	- during user maintenance,		P
	- when replacing a supply cord having a type X attachment, or		N/A
	- during installation		P
	At least two screws being used for each connection providing earthing continuity, unless		P
	the screw forms a thread having a length of at least half the diameter of the screw		N/A
28.4	Screws and nuts that make mechanical connection secured against loosening if they also make electrical connections or connections providing earthing continuity		P
	This requirement does not apply to screws in the earthing circuit if at least two screws are used, or		P
	if an alternative earthing circuit is provided		N/A
	Rivets for electrical connections or connections providing earthing continuity secured against loosening if the connections are subjected to torsion		N/A
29	CLEARANCES, CREEPAGE DISTANCES AND SOLID INSULATION		--
	Clearances, creepage distances and solid insulation withstand electrical stress		P

IEC 60335-2-40			
Clause	Requirement + Test	Result - Remark	Verdict
	For coatings used on printed circuits boards to protect the microenvironment (Type 1) or to provide basic insulation (Type 2), annex J applies ..... :		N/A
	The microenvironment is pollution degree 1 under type 1 protection		N/A
	For type 2 protection, the spacing between the conductors before the protection is applied is not less than the values specified in Table 1 of IEC 60664-3		N/A
	These values apply to functional, basic, supplementary and reinforced insulation..... :		N/A
	For motor-compressor not complying with IEC 60335-2-34, additions and modifications as specified (IEC 60335-2-40)		P
29.1	Clearances not less than the values specified in table 16, taking into account the rated impulse voltage for the overvoltage categories of table 15, unless ..... :	(see appended table)	P
	for basic insulation and functional insulation they comply with the impulse voltage test of clause 14		N/A
	However, if the distances are affected by wear, distortion, movement of the parts or during assembly, the clearances for rated impulse voltages of 1500 V and above are increased by 0,5 mm and the impulse voltage test is not applicable		P
	Impulse voltage test is not applicable:		--
	- when the microenvironment is pollution degree 3, or		N/A
	- for basic insulation of class 0 and class 01 appliances		N/A
	Appliances are in overvoltage category II		P
	A force of 2 N is applied to bare conductors, other than heating elements		P
	A force of 30 N is applied to accessible surfaces		P
29.1.1	Clearances of basic insulation withstand the overvoltages, taking into account the rated impulse voltage		P
	The values of table 16 or the impulse voltage test of clause 14 are applicable..... :	(see appended table)	P
	Clearance at the terminals of tubular sheathed heating elements may be reduced to 1,0 mm if the microenvironment is pollution degree 1		N/A
	Lacquered conductors of windings considered to be bare conductors		P

<b>IEC 60335-2-40</b>			
Clause	Requirement + Test	Result - Remark	Verdict
29.1.2	Clearances of supplementary insulation not less than those specified for basic insulation in table 16 ..... :	(see appended table)	P
29.1.3	Clearances of reinforced insulation not less than those specified for basic insulation in table 16, using the next higher step for rated impulse voltage ..... :	(see appended table)	P
	For double insulation, with no intermediate conductive part between basic and supplementary insulation, clearances are measured between live parts and the accessible surface, and the insulation system is treated as reinforced insulation		P
29.1.4	Clearances for functional insulation are the largest values determined from:		--
	- table 16 based on the rated impulse voltage ..... :	(see appended table)	P
	- table F.7a in IEC 60664-1, frequency not exceeding 30 kHz		P
	- clause 4 of IEC 60664-4, frequency exceeding 30 kHz		N/A
	If values of table 16 are largest, the impulse voltage test of clause 14 may be applied instead, unless		P
	the microenvironment is pollution degree 3, or		N/A
	the distances can be affected by wear, distortion, movement of the parts or during assembly		P
	However, clearances are not specified if the appliance complies with clause 19 with the functional insulation short-circuited		N/A
	Lacquered conductors of windings considered to be bare conductors		P
	However, clearances at crossover points are not measured		P
	Clearance between surfaces of PTC heating elements may be reduced to 1mm		N/A
29.1.5	Appliances having higher working voltages than rated voltage, clearances for basic insulation are the largest values determined from:		--
	- table 16 based on the rated impulse voltage ..... :	(see appended table)	P
	- table F.7a in IEC 60664-1, frequency not exceeding 30 kHz		P
	- clause 4 of IEC 60664-4, frequency exceeding 30 kHz		N/A
	If clearances for basic insulation are selected from Table F.7a of IEC 60664-1 or clause 4 of IEC 60664-4, the clearances of supplementary insulation are not less than those specified for basic insulation		N/A

<b>IEC 60335-2-40</b>			
Clause	Requirement + Test	Result - Remark	Verdict
	If clearances for basic insulation are selected from Table F.7a of IEC 60664-1, the clearances of reinforced insulation dimensioned as specified in Table F.7a are to withstand 160% of the withstand voltage required for basic insulation		N/A
	If clearances for basic insulation are selected from clause 4 of IEC 60664-4, the clearances of reinforced insulation are twice the value required for basic insulation		N/A
	If the secondary winding of a step-down transformer is earthed, or if there is an earthed screen between the primary and secondary windings, clearances of basic insulation on the secondary side not less than those specified in table 16, but using the next lower step for rated impulse voltage		N/A
	Circuits supplied with a voltage lower than rated voltage, clearances of functional insulation are based on the working voltage used as the rated voltage in table 15		N/A
29.2	Creepage distances not less than those appropriate for the working voltage, taking into account the material group and the pollution degree..... :	(see appended table)	P
	Pollution degree 2 applies, unless		P
	- precautions taken to protect the insulation; pollution degree 1		N/A
	- insulation subjected to conductive pollution; pollution degree 3	For insulation located in airflow	P
	A force of 2 N is applied to bare conductors, other than heating elements		P
	A force of 30 N is applied to accessible surfaces		P
	In a double insulation system, the working voltage for both the basic and supplementary insulation is taken as the working voltage across the complete double insulation system		P
	Insulation located in airflow, pollution degree 3 unless (IEC 60335-2-40)		P
	insulation enclosed or located so that unlikely to be exposed to pollution due to normal use (IEC 60335-2-40)		P
29.2.1	Creepage distances of basic insulation not less than specified in table 17..... :	(see appended table)	P
	However, if the working voltage is periodic and has a frequency exceeding 30 kHz, the creepage distances are also determined from table 2 of IEC 60664-4, these values being used if exceeding the values in table 17..... :		N/A

IEC 60335-2-40			
Clause	Requirement + Test	Result - Remark	Verdict
	Except for pollution degree 1, corresponding creepage distance not less than the minimum specified for the clearance in table 16, if the clearance has been checked according to the test of clause 14 .....		N/A
29.2.2	Creepage distances of supplementary insulation at least those specified for basic insulation in table 17, or.....	(see appended table)	P
	Table 2 of IEC 60664-4, as applicable .....		N/A
29.2.3	Creepage distances of reinforced insulation at least double those specified for basic insulation in table 17, or.....	(see appended table)	P
	Table 2 of IEC 60664-4, as applicable .....		N/A
29.2.4	Creepage distances of functional insulation not less than specified in table 18.....	(see appended table)	P
	However, if the working voltage is periodic and has a frequency exceeding 30 kHz, the creepage distances are also determined from table 2 of IEC 60664-4, these values being used if exceeding the values in table 18.....		N/A
	Creepage distances may be reduced if the appliance complies with clause 19 with the functional insulation short-circuited		N/A
29.3	Supplementary and reinforced insulation have adequate thickness, or a sufficient number of layers, to withstand the electrical stresses		P
	Compliance checked:		--
	- by measurement, in accordance with 29.3.1, or		P
	- by an electric strength test in accordance with 29.3.2, or		P
	- by an assessment of the thermal quality of the material combined with an electric strength test, in accordance with 29.3.3, and		N/A
	for accessible parts of reinforced insulation consisting of a single layer, by measurement in accordance with 29.3.4, or		N/A
	- as specified in subclause 6.3 of IEC 60664-4 for insulation that is subjected to any periodic voltage having a frequency exceeding 30 kHz		N/A
29.3.1	Supplementary insulation have a thickness of at least 1 mm		P
	Reinforced insulation have a thickness of at least 2 mm		N/A
29.3.2	Each layer of material withstand the electric strength test of 16.3 for supplementary insulation		P

IEC 60335-2-40			
Clause	Requirement + Test	Result - Remark	Verdict
	Supplementary insulation consist of at least 2 layers		P
	Reinforced insulation consist of at least 3 layers		N/A
29.3.3	The insulation is subjected to the dry heat test Bb of IEC 60068-2-2, followed by		N/A
	the electric strength test of 16.3		N/A
	If the temperature rise during the tests of clause 19 does not exceed the value specified in table 3, the test of IEC 60068-2-2 is not carried out		N/A
29.3.4	Thickness of accessible parts of reinforced insulation consisting of a single layer not less than specified in table 19..... :		N/A
30	RESISTANCE TO HEAT AND FIRE		--
30.1	External parts of non-metallic material,		P
	parts supporting live parts, and		P
	parts of thermoplastic material providing supplementary or reinforced insulation		P
	sufficiently resistant to heat		P
	Ball-pressure test according to IEC 60695-10-2		P
	External parts tested at 40 °C plus the maximum temperature rise determined during the test of clause 11, or at 75 °C, whichever is the higher; temperature (°C)..... :	(see appended table)	P
	Parts supporting live parts tested at 40 °C plus the maximum temperature rise determined during the test of clause 11, or at 125 °C, whichever is the higher; temperature (°C)..... :	(see appended table)	P
	Parts of thermoplastic material providing supplementary or reinforced insulation tested at 25 °C plus the maximum temperature rise determined during clause 19, if higher; temperature (°C) .....		N/A
30.2	Parts of non-metallic material resistant to ignition and spread of fire		P
	This requirement does not apply to:		--
	parts having a mass not exceeding 0,5 g, provided the cumulative effect is unlikely to propagate flames that originate inside the appliance by propagating flames from one part to another, or		P
	decorative trims, knobs and other parts unlikely to be ignited or to propagate flames that originate inside the appliance		P
	Compliance checked by the test of 30.2.1, and in addition:		P

IEC 60335-2-40			
Clause	Requirement + Test	Result - Remark	Verdict
	- for attended appliances, 30.2.2 applies		N/A
	- for unattended appliances, 30.2.3 applies		P
	For appliances for remote operation, 30.2.3 applies		N/A
	For base material of printed circuit boards, 30.2.4 applies		P
30.2.1	Parts of non-metallic material subjected to the glow-wire test of IEC 60695-2-11 at 550 °C		P
	However, test not carried out if the material is classified as having a glow-wire flammability index according to IEC 60695-2-12 of at least 550 °C, or		P
	the material is classified at least HB40 according to IEC 60695-11-10		N/A
	Parts for which the glow-wire test cannot be carried out need to meet the requirements in ISO 9772 for material classified HBF		N/A
30.2.3	Appliances operated while unattended, tested as specified in 30.2.3.1 and 30.2.3.2		P
	The tests are not applicable to conditions as specified..... :		N/A
30.2.3.1	Parts of non-metallic material supporting connections carrying a current exceeding 0,2 A during normal operation, and		P
	parts of non-metallic material, other than small parts, within a distance of 3 mm,		P
	subjected to the glow-wire test of IEC 60695-2-11 with a test severity of 850 °C		P
	Glow-wire applied to an interposed shielding material, if relevant		N/A
	The glow-wire test is not carried out on parts of material classified as having a glow-wire flammability index according to IEC 60695-2-12 of at least 850 °C		N/A
30.2.3.2	Parts of non-metallic material supporting connections, and		P
	parts of non-metallic material within a distance of 3 mm,		P
	subjected to glow-wire test of IEC 60695-2-11		P
	The test severity is:		--
	- 750 °C, for connections carrying a current exceeding 0,2 A during normal operation		P
	- 650 °C, for other connections		P
	Glow-wire applied to an interposed shielding material, if relevant		N/A

IEC 60335-2-40			
Clause	Requirement + Test	Result - Remark	Verdict
	However, the glow-wire test of 750 °C or 650 °C as appropriate, is not carried out on parts of material fulfilling both or either of the following classifications:		--
	- a glow-wire ignition temperature according to IEC 60695-2-13 of at least:		N/A
	- 775 °C, for connections carrying a current exceeding 0,2 A during normal operation		N/A
	- 675 °C, for other connections		N/A
	- a glow-wire flammability index according to IEC 60695-2-12 of at least:		N/A
	- 750 °C, for connections carrying a current exceeding 0,2 A during normal operation		N/A
	- 650 °C, for other connections		N/A
	The glow-wire test is also not carried out on small parts. These parts are to:		--
	- comprise material having a glow-wire ignition temperature of at least 775 °C or 675 °C as appropriate, or		N/A
	- comprise material having a glow-wire flammability index of at least 750 °C or 650 °C as appropriate, or		N/A
	- comply with the needle-flame test of annex E, or		N/A
	- comprise material classified as V-0 or V-1 according to IEC 60695-11-10		N/A
	The consequential needle-flame test of annex E applied to non-metallic parts that encroach within the vertical cylinder placed above the centre of the connection zone and on top of the non-metallic parts supporting current-carrying connections, and parts of non-metallic material within a distance of 3 mm of such connections if these parts are those:		--
	- parts that withstood the glow-wire test of IEC 60695-2-11 of 750 °C or 650 °C as appropriate, but produce a flame that persist longer than 2 s, or		N/A
	- parts that comprised material having a glow-wire flammability index of at least 750 °C or 650 °C as appropriate, or		N/A
	- small parts, that comprised material having a glow-wire flammability index of at least 750 °C or 650 °C as appropriate, or		N/A
	- small parts for which the needle-flame test of annex E was applied, or		N/A
	- small parts for which a material classification of V-0 or V-1 was applied		N/A
	However, the consequential needle-flame test is not carried out on non-metallic parts, including small parts, within the cylinder that are:		-
	- parts having a glow-wire ignition temperature of at least 775 °C or 675 °C as appropriate, or		N/A

<b>IEC 60335-2-40</b>			
Clause	Requirement + Test	Result - Remark	Verdict
	- parts comprising material classified as V-0 or V-1 according to IEC 60695-11-10, or		N/A
	- parts shielded by a flame barrier that meets the needle-flame test of annex E or that comprises material classified as V-0 or V-1 according to IEC 60695-11-10		N/A
30.2.4	Base material of printed circuit boards subjected to the needle-flame test of annex E		P
	Test not applicable to conditions as specified ..... :		N/A
31	<b>RESISTANCE TO RUSTING</b>		--
	Relevant ferrous parts adequately protected against rusting		P
	Tests specified in part 2 when necessary		P
	Salt mist test of IEC 60068-2-52, severity 2 (IEC 60335-2-40)		P
	Before test, coatings are scratched by means of a harden steel pin as specified (IEC 60335-2-40)		P
	Five scratches made at least 5 mm apart and at least 5 mm from the edges (IEC 60335-2-40)		P
	Appliance not deteriorated to such an extent that compliance with clause 8 and 27 is impaired (IEC 60335-2-40)		P
	Coating not be broken and not loosened from the metal surface (IEC 60335-2-40)		P
32	<b>RADIATION, TOXICITY AND SIMILAR HAZARDS</b>		P
A	<b>ANNEX A (INFORMATIVE) ROUTINE TESTS</b>		--
	Description of routine tests to be carried out by the manufacturer		N/A
B	<b>ANNEX B (NORMATIVE) APPLIANCES POWERED BY RECHARGEABLE BATTERIES</b>		--
	The following modifications to this standard are applicable for appliances powered by batteries that are recharged in the appliance		N/A
	This annex does not apply to battery chargers		N/A
3.1.9	Appliance operated under the following conditions:		--
	- the appliance, supplied by its fully charged battery, operated as specified in relevant part 2		N/A
	- the battery is charged, the battery being initially discharged to such an extent that the appliance cannot operate		N/A

IEC 60335-2-40			
Clause	Requirement + Test	Result - Remark	Verdict
	- if possible, the appliance is supplied from the supply mains through its battery charger, the battery being initially discharged to such an extent that the appliance cannot operate. The appliance is operated as specified in relevant part 2		N/A
	- if the appliance incorporates inductive coupling between two parts that are detachable from each other, the appliance is supplied from the supply mains with the detachable part removed		N/A
3.6.2	Part to be removed in order to discard the battery is not considered to be detachable		N/A
5.B.101	Appliances supplied from the supply mains tested as specified for motor-operated appliances		N/A
7.1	Battery compartment for batteries intended to be replaced by the user, marked with battery voltage and polarity of the terminals		N/A
	The positive terminal indicated by symbol IEC 60417-5005 and the negative terminal by symbol IEC 60417-5006		N/A
7.6	Symbols 60417-5005 and IEC 60417-5006		N/A
7.12	The instructions give information regarding charging		N/A
	The instructions for appliances incorporating batteries intended to be replaced by the user includes required information		N/A
	Details about how to remove batteries containing materials hazardous to the environment given		N/A
7.15	Markings placed on the part of the appliance connected to the supply mains		N/A
8.2	Appliances having batteries that according to the instruction may be replaced by the user need only have basic insulation between live parts and the inner surface of the battery compartment		N/A
	If the appliance can be operated without batteries, double or reinforced insulation required		N/A
11.7	The battery is charged for the period stated in the instructions or 24 h .....		N/A
19.1	Appliances subjected to tests of 19.B.101, 19.B.102 and 19.B.103		N/A
19.10	Not applicable		N/A
19.B.101	Appliances supplied at rated voltage for 168 h, the battery being continually charged		N/A
19.B.102	For appliances having batteries that can be removed without the aid of a tool, short-circuit of the terminals of the battery, the battery being fully charged,		N/A

IEC 60335-2-40			
Clause	Requirement + Test	Result - Remark	Verdict
19.B.103	Appliances having batteries replaceable by the user supplied at rated voltage under normal operation with the battery removed or in any position allowed by the construction		N/A
21.B.101	Appliances having pins for insertion into socket-outlets have adequate mechanical strength		N/A
	Part of the appliance incorporating the pins subjected to the free fall test, procedure 2, of IEC 60068-2-31, the number of falls being:		--
	- 100, if the mass of the part does not exceed 250 g (g) .....		N/A
	- 50, if the mass of the part exceeds 250 g .....		N/A
	After the test, the requirements of 8.1, 15.1.1, 16.3 and clause 29 are met		N/A
22.3	Appliances having pins for insertion into socket-outlets tested as fully assembled as possible		N/A
25.13	An additional lining or bushing not required for interconnection cords in class III appliances or class III constructions operating at safety extra-low voltage not containing live parts		N/A
30.2	For parts of the appliance connected to the supply mains during the charging period, 30.2.3 applies		N/A
	For other parts, 30.2.2 applies		N/A
C	ANNEX C (NORMATIVE) AGEING TEST ON MOTORS		--
	Tests, as described, carried out when doubt with regard to the temperature classification of the insulation of a motor winding		N/A
	Test conditions as specified		N/A
E	ANNEX E (NORMATIVE) NEEDLE-FLAME TEST		--
	Needle-flame test carried out in accordance with IEC 60695-11-5, with the following modifications:		--
7	Severities		--
	The duration of application of the test flame is 30 s ± 1 s		P
9	Test procedure		--
9.1	The specimen so arranged that the flame can be applied to a vertical or horizontal edge as shown in the examples of figure 1		P
9.2	The first paragraph does not apply		P
	If possible, the flame is applied at least 10 mm from a corner		P
9.3	The test is carried out on one specimen		P

IEC 60335-2-40			
Clause	Requirement + Test	Result - Remark	Verdict
	If the specimen does not withstand the test, the test may be repeated on two additional specimens, both withstanding the test		N/A
11	Evaluation of test results		--
	The duration of burning not exceeding 30 s		N/A
	However, for printed circuit boards, the duration of burning not exceeding 15 s		P
F	ANNEX F (NORMATIVE) CAPACITORS		--
	Capacitors likely to be permanently subjected to the supply voltage, and used for radio interference suppression or voltage dividing, comply with the following clauses of IEC 60384-14, with the following modifications:		--
1.5	Terms and definitions		--
1.5.3	Class X capacitors tested according to subclass X2		N/A
1.5.4	This subclause is applicable		N/A
1.6	Marking		--
	Items a) and b) are applicable		--
3.4	Approval testing		
3.4.3.2	Table 3 is applicable as described		N/A
4.1	Visual examination and check of dimensions		--
	This subclause is applicable		N/A
4.2	Electrical tests		--
4.2.1	This subclause is applicable		N/A
4.2.5	This subclause is applicable		N/A
4.2.5.2	Only table 11 is applicable		N/A
	Values for test A apply		N/A
	However, for capacitors in heating appliances the values for test B or C apply		N/A
4.12	Damp heat, steady state		--
	This subclause is applicable		N/A
	Only insulation resistance and voltage proof are checked		N/A
4.13	Impulse voltage		--
	This subclause is applicable		N/A
4.14	Endurance		--
	Subclauses 4.14.1, 4.14.3, 4.14.4 and 4.14.7 are applicable		N/A
4.14.7	Only insulation resistance and voltage proof are checked		N/A

IEC 60335-2-40			
Clause	Requirement + Test	Result - Remark	Verdict
	No visible damage		N/A
4.17	Passive flammability test		--
	This subclause is applicable		N/A
4.18	Active flammability test		--
	This subclause is applicable		N/A
G	ANNEX G (NORMATIVE) SAFETY ISOLATING TRANSFORMERS		--
	The following modifications to this standard are applicable for safety isolating transformers:		--
7	Marking and instructions		--
7.1	Transformers for specific use marked with:		--
	- name, trademark or identification mark of the manufacturer or responsible vendor..... :		N/A
	- model or type reference..... :		N/A
17	Overload protection of transformers and associated circuits		--
	Fail-safe transformers comply with subclause 15.5 of IEC 61558-1		N/A
22	Construction		--
	Subclauses 19.1 and 19.1.2 of IEC 61558-2-6 are applicable		N/A
29	Clearances, creepage distances and solid insulation		--
29.1, 29.2, 29.3	The distances specified in items 2a, 2c and 3 in table 13 of IEC 61558-1 apply		N/A
	For insulated winding wires complying with subclause 19.12.3 of IEC 61558-1 there are no requirements for clearances or creepage distances		N/A
	For windings providing reinforced insulation, the distance specified in item 2c of table 13 of IEC 61558-1 is not assessed		N/A
	For safety isolating transformers subjected to periodic voltages with a frequency exceeding 30 kHz, the clearances, creepage distances and solid insulation values specified in IEC 60664-4 are applicable, if greater than the values specified in items 2a, 2c and 3 in table 13 of IEC 61558-1		N/A
H	ANNEX H (NORMATIVE) SWITCHES		--
	Switches comply with the following clauses of IEC 61058-1, as modified below:		--
	The tests of IEC 61058-1 carried out under the conditions occurring in the appliance		N/A
	Before being tested, switches are operated 20 times without load		N/A

IEC 60335-2-40			
Clause	Requirement + Test	Result - Remark	Verdict
8	Marking and documentation		--
	Switches are not required to be marked		N/A
	However, a switch that can be tested separately from the appliance marked with the manufacturer's name or trade mark and the type reference		N/A
13	Mechanism		--
	The tests may be carried out on a separate sample		N/A
15	Insulation resistance and dielectric strength		--
15.1	Not applicable		N/A
15.2	Not applicable		N/A
15.3	Applicable for full disconnection and micro-disconnection		N/A
17	Endurance		--
	Compliance is checked on three separate appliances or switches		N/A
	For 17.2.4.4, the number of cycles declared according to 7.1.4 is 10 000, unless		N/A
	otherwise specified in 24.1.3 of the relevant part 2 of IEC 60335..... :		N/A
	Switches for operation under no load and which can be operated only by a tool, and		N/A
	switches operated by hand that are interlocked so that they cannot be operated under load,		N/A
	are not subjected to the tests		N/A
	However, switches without this interlock are subjected to the test of 17.2.4.4 for 100 cycles of operation		N/A
	Subclauses 17.2.2 and 17.2.5.2 not applicable		N/A
	The ambient temperature during the test is that occurring in the appliance during the test of clause 11 in IEC 60335-1		N/A
	The temperature rise of the terminals not more than 30 K above the temperature rise measured in clause 11 of IEC 60335-1 (K) ..... :		N/A
20	Clearances, creepage distances, solid insulation and coatings of rigid printed board assemblies		--
	This clause is applicable to clearances and creepage distances for functional insulation, across full disconnection and micro-disconnection, as stated in table 24		N/A
J	ANNEX J (NORMATIVE) COATED PRINTED CIRCUIT BOARDS		--

IEC 60335-2-40			
Clause	Requirement + Test	Result - Remark	Verdict
	Testing of protective coatings of printed circuit boards carried out in accordance with IEC 60664-3 with the following modifications:		--
5.7	Conditioning of the test specimens		--
	When production samples are used, three samples of the printed circuit board are tested		N/A
5.7.1	Cold		--
	The test is carried out at -25 °C		N/A
5.7.3	Rapid change of temperature		--
	Severity 1 is specified		N/A
5.9	Additional tests		--
	This subclause is not applicable		N/A
K	ANNEX K (NORMATIVE) OVERVOLTAGE CATEGORIES		--
	The information on overvoltage categories is extracted from IEC 60664-1		P
	Overtoltage category is a numeral defining a transient overvoltage condition		P
	Equipment of overvoltage category IV is for use at the origin of the installation		N/A
	Equipment of overvoltage category III is equipment in fixed installations and for cases where the reliability and the availability of the equipment is subject to special requirements		N/A
	Equipment of overvoltage category II is energy consuming equipment to be supplied from the fixed installation		P
	If such equipment is subjected to special requirements with regard to reliability and availability, overvoltage category III applies		N/A
	Equipment of overvoltage category I is equipment for connection to circuits in which measures are taken to limit transient overvoltages to an appropriate low level		N/A
L	ANNEX L (INFORMATIVE) GUIDANCE FOR THE MEASUREMENT OF CLEARANCES AND CREEPAGE DISTANCES		--
	Information for the determination of clearances and creepage distances		P
M	ANNEX M (NORMATIVE) POLLUTION DEGREE		--
	The information on pollution degrees is extracted from IEC 60664-1		P
	Pollution		--

IEC 60335-2-40			
Clause	Requirement + Test	Result - Remark	Verdict
	The microenvironment determines the effect of pollution on the insulation, taking into account the macroenvironment		P
	Means may be provided to reduce pollution at the insulation by effective enclosures or similar		P
	Minimum clearances specified where pollution may be present in the microenvironment		P
	Degrees of pollution in the microenvironment		--
	For evaluating creepage distances, the following degrees of pollution in the microenvironment are established:		P
	- pollution degree 1: no pollution or only dry, non-conductive pollution occurs. The pollution has no influence		N/A
	- pollution degree 2: only non-conductive pollution occurs, except that occasionally a temporary conductivity caused by condensation is to be expected	For PCB	P
	- pollution degree 3: conductive pollution occurs or dry non-conductive pollution occurs that becomes conductive due to condensation that is to be expected	For insulation located in airflow	P
	- pollution degree 4: the pollution generates persistent conductivity caused by conductive dust or by rain or snow		N/A
N	ANNEX N (NORMATIVE) PROOF TRACKING TEST		--
	The proof tracking test is carried out in accordance with IEC 60112 with the following modifications:		--
7	Test apparatus		--
7.3	Test solutions		--
	Test solution A is used		P
10	Determination of proof tracking index (PTI)		--
10.1	Procedure		--
	The proof voltage is 100 V, 175 V, 400 V or 600 V ..... :	175 V	P
	The test is carried out on five specimens		P
	In case of doubt, additional test with proof voltage reduced by 25 V, the number of drops increased to 100		N/A
10.2	Report		--
	The report states if the PTI value was based on a test using 100 drops with a test voltage of (PTI-25) V		N/A

IEC 60335-2-40			
Clause	Requirement + Test	Result - Remark	Verdict
O	ANNEX O (INFORMATIVE) SELECTION AND SEQUENCE OF THE TESTS OF clause 30		--
	Description of tests for determination of resistance to heat and fire		P
P	ANNEX P (INFORMATIVE) GUIDANCE FOR THE APPLICATION OF THIS STANDARD TO APPLIANCES USED IN WARM DAMP EQUABLE CLIMATES		--
	Modifications applicable for class 0 and 01 appliances having a rated voltage exceeding 150 V, intended to be used in countries having a warm damp equable climate and that are marked WDaE		--
	Modifications may also be applied to class 1 appliances having a rated voltage exceeding 150 V, intended to be used in countries having a warm damp equable climate and that are marked WDaE, if liable to be connected to a supply mains that excludes the protective earthing conductor		--
5.7	The ambient temperature for the tests of clauses 11 and 13 is 40 +3/0 °C		N/A
7.1	The appliance marked with the letters WDaE		N/A
7.12	The instructions state that the appliance is to be supplied through a residual current device (RCD) having a rated residual operating current not exceeding 30 mA		N/A
	The instructions state that the appliance is considered to be suitable for use in countries having a warm damp equable climate, but may also be used in other countries		N/A
11.8	The values of Table 3 are reduced by 15 K		N/A
13.2	The leakage current for class I appliances not exceeding 0,5 mA		N/A
15.3	The value of t is 37 °C		N/A
16.2	The leakage current for class I appliances not exceeding 0,5 mA (mA):		N/A
19.13	The leakage current test of 16.2 is applied in addition to the electric strength test of 16.3		N/A
Q	ANNEX Q (INFORMATIVE) SEQUENCE OF TESTS FOR THE EVALUATION OF ELECTRONIC CIRCUITS		--
	Description of tests for appliances incorporating electronic circuits		--
R	ANNEX R (NORMATIVE) SOFTWARE EVALUATION		--
	Programmable electronic circuits requiring software incorporating measures to control the fault/error conditions specified in table R.1 or R.2 validated in accordance with the requirements of this annex		N/A
R.1	Programmable electronic circuits using software		--

IEC 60335-2-40			
Clause	Requirement + Test	Result - Remark	Verdict
	Programmable electronic circuits requiring software incorporating measures to control the fault/error conditions specified in table R.1 or R.2 constructed so that the software does not impair compliance with the requirements of this standard		N/A
R.2	Requirements for the architecture		--
	Programmable electronic circuits requiring software incorporating measures to control the fault/error conditions specified in table R.1 or R.2 use measures to control and avoid software-related faults/errors in safety-related data and safety-related segments of the software		N/A
R.2.1.1	Programmable electronic circuits requiring software incorporating measures to control the fault/error conditions specified in table R.2 have one of the following structures:		--
	- single channel with periodic self-test and monitoring		N/A
	- dual channel (homogenous) with comparison		N/A
	- dual channel (diverse) with comparison		N/A
	Programmable electronic circuits requiring software incorporating measures to control the fault/error conditions specified in table R.1 have one of the following structures:		--
	- single channel with functional test		N/A
	- single channel with periodic self-test		N/A
	- dual channel without comparison		N/A
R.2.2	Measures to control faults/errors		--
R.2.2.1	When redundant memory with comparison is provided on two areas of the same component, the data in one area is stored in a different format from that in the other area		N/A
R.2.2.2	Programmable electronic circuits with functions requiring software incorporating measures to control the fault/error conditions specified in table R.2 and that use dual channel structures with comparison, have additional fault/error detection means for any fault/errors not detected by the comparison		N/A
R.2.2.3	For programmable electronic circuits with functions requiring software incorporating measures to control the fault/error conditions specified in table R.1 or R.2, means are provided for the recognition and control of errors in transmissions to external safety-related data paths		N/A

IEC 60335-2-40			
Clause	Requirement + Test	Result - Remark	Verdict
R.2.2.4	For programmable electronic circuits with functions requiring software incorporating measures to control the fault/error conditions specified in table R.1 or R.2, the programmable electronic circuits incorporate measures to address the fault/errors in safety-related segments and data indicated in table R.1 and R.2 as appropriate		N/A
R.2.2.5	For programmable electronic circuits with functions requiring software incorporating measures to control the fault/error conditions specified in table R.1 or R.2, detection of a fault/error occur before compliance with clause 19 is impaired		N/A
R.2.2.6	The software is referenced to relevant parts of the operating sequence and the associated hardware functions		N/A
R.2.2.7	Labels used for memory locations are unique		N/A
R.2.2.8	The software is protected from user alteration of safety-related segments and data		N/A
R.2.2.9	Software and safety-related hardware under its control is initialized and terminates before compliance with clause 19 is impaired		N/A
R.3	Measures to avoid errors		--
R.3.1	General		--
	For programmable electronic circuits with functions requiring software incorporating measures to control the fault/error conditions specified in table R.1 or R.2, the following measures to avoid systematic fault in the software are applied		--
	Software that incorporates measures used to control the fault/error conditions specified in table R.2 is inherently acceptable for software required to control the fault/error conditions specified in table R.1		N/A
R.3.2	Specification		--
R.3.2.1	Software safety requirements:	Software Id:	N/A
	The specification of the software safety requirements includes the descriptions listed		N/A
R.3.2.2	Software architecture		--

IEC 60335-2-40			
Clause	Requirement + Test	Result - Remark	Verdict
R.3.2.2.1	The specification of the software architecture includes the aspects listed - techniques and measures to control software faults/errors (refer to R.2.2); - interactions between hardware and software; - partitioning into modules and their allocation to the specified safety functions; - hierarchy and call structure of the modules (control flow); - interrupt handling; - data flow and restrictions on data access; - architecture and storage of data; - time-based dependencies of sequences and data	Document ref. No:	N/A
R.3.2.2.2	The architecture specification is validated against the specification of the software safety requirements by static analysis		N/A
R.3.2.3	Module design and coding		--
R.3.2.3.1	Based on the architecture design, software is suitably refined into modules		N/A
	Software module design and coding is implemented in a way that is traceable to the software architecture and requirements		N/A
R.3.2.3.2	Software code is structured		N/A
R.3.2.3.3	Coded software is validated against the module specification by static analysis		N/A
	The module specification is validated against the architecture specification by static analysis		N/A
R.3.3.3	Software validation		--
	The software is validated with reference to the requirements of the software safety requirements specification		N/A
	Compliance is checked by simulation of:		--
	- input signals present during normal operation		N/A
	- anticipated occurrences		N/A
	- undesired conditions requiring system action		N/A

IEC 60335-2-40			
Clause	Requirement + Test	Result - Remark	Verdict

TABLE R.1 <sup>e</sup> – GENERAL FAULT/ERROR CONDITIONS						
Component <sup>a</sup>	Fault/error	Acceptable measures <sup>b, c</sup>	Definitions	Document reference for applied measure	Document reference for applied test	Verdict
1 CPU						N/A
1.1 Registers	Stuck at	Functional test, or periodic self-test using either: - static memory test, or - word protection with single bit redundancy	H.2.16.5 H.2.16.6 H.2.19.6 H.2.19.8.2			
1.2 VOID						N/A
1.3 Programme counter	Stuck at	Functional test, or Periodic self-test, or Independent time-slot monitoring, or Logical monitoring of the programme sequence	H.2.16.5 H.2.16.6 H.2.18.10.4 H.2.18.10.2			N/A
2 Interrupt handling and execution	No interrupt or too frequent interrupt	Functional test, or time-slot monitoring	H.2.16.5 H.2.18.10.4			N/A
3 Clock	Wrong frequency (for quartz synchronized clock: harmonics/sub-harmonics only)	Frequency monitoring, or time slot monitoring	H.2.18.10.1 H.2.18.10.4			N/A
4. Memory						N/A
4.1 Invariable memory	All single bit faults	Periodic modified checksum, or multiple checksum, or word protection with single bit redundancy	H.2.19.3.1 H.2.19.3.2 H.2.19.8.2			
4.2 Variable memory	DC fault	Periodic static memory test, or word protection with single bit redundancy	H.2.19.6 H.2.19.8.2			N/A

IEC 60335-2-40						
Clause	Requirement + Test		Result - Remark			Verdict
4.3 Addressing (relevant to variable and invariable memory)	Stuck at	Word protection with single bit redundancy including the address	H.2.19.8.2			N/A
5 Internal data path	Stuck at	Word protection with single bit redundancy	H.2.19.8.2			N/A
5.1 VOID						N/A
5.2 Addressing	Wrong address	Word protection with single bit redundancy including the address	H.2.19.8.2			N/A
6 External communication	Hamming distance 3	Word protection with multi-bit redundancy, or  CRC – single work, or  Transfer redundancy, or  Protocol test	H.2.19.8.1  H.2.19.4.1 H.2.18.2.2 H.2.18.14			N/A
6.1 VOID						N/A
6.2 VOID						N/A
6.3 Timing	Wrong point in time          Wrong sequence	Time-slot monitoring, or scheduled transmission  Time-slot and logical monitoring, or  comparison of redundant communication channels by either:  - reciprocal comparison - independent hardware comparator  Logical monitoring, or time-slot monitoring, or Scheduled transmission	H.2.18.10.4 H.2.18.18 H.2.18.10.3  H.2.18.15 H.2.18.3 H.2.18.10.2 H.2.18.10.4 H.2.18.18			N/A
7 Input/output periphery	Fault conditions specified in 19.11.2	Plausibility check	H.2.18.13			N/A
7.1 VOID						N/A
7.2 Analog I/O						N/A
7.2.1 A/D and D/A- converter	Fault conditions specified in 19.11.2	Plausibility check	H.2.18.13			N/A

IEC 60335-2-40						
Clause	Requirement + Test		Result - Remark			Verdict
7.2.2 Analog multiplexer	Wrong addressing	Plausibility check	H.2.18.13			N/A
8 VOID						N/A
9 Custom chips <sup>d</sup> e.g. ASIC, GAL, gate array	Any output outside the static and dynamic functional specificatio n	Periodic self-test	H.2.16.6			N/A
NOTE A Stuck-at fault model denotes a fault model representing an open circuit or a non-varying signal level. A DC fault model denotes a stuck-at fault model incorporating short circuit between signal lines.						
<p>a) For fault/error assessment, some components are divided into their sub-functions.</p> <p>b) For each sub-function in the table, the Table R.2 measure will cover the software fault/error.</p> <p>c) Where more than one measure is given for a sub-function, these are alternatives.</p> <p>d) To be divided as necessary by the manufacturer into sub-functions.</p> <p>e) Table R.1 is applied according to the requirements of R.1 to R.2.2.9 inclusive.</p>						

IEC 60335-2-40			
Clause	Requirement + Test	Result - Remark	Verdict
<b>AA</b>	<b>ANNEX AA (INFORMATIVE) (IEC 60335-2-40) EXAMPLES FOR OPERATING TEMPERATURES OF THE APPLIANCE</b>		--
<b>BB</b>	<b>ANNEX BB (NORMATIVE) (IEC 60335-2-40) SELECTED INFORMATION ABOUT REFRIGERANTS</b>		--
<b>CC</b>	<b>ANNEX CC (INFORMATIVE) (IEC/EN 60335-2-40/A1) TRANSPORTATION, MARKING AND STORAGE FOR UNITS THAT EMPLOY FLAMMABLE REFRIGERANTS</b>		--
CC.1	Transport of equipment containing flammable refrigerants (IEC 60335-2-40/A1)		P
CC.2	Marking of equipment using signs (IEC 60335-2-40/A1)		P
CC.3	Disposal of equipment using flammable refrigerants (IEC 60335-2-40/A1)		P
CC.4	Storage of equipment/appliances (IEC 60335-2-40/A1)		P
CC.5	Storage of packed (unsold) equipment (IEC 60335-2-40/A1)		P
<b>DD</b>	<b>ANNEX DD (NORMATIVE) (IEC/EN 60335-2-40/A1) SERVICE OPERATIONS</b>		--
DD.1	Generals (IEC 60335-2-40/A1)		P
DD.2	Symbols (IEC 60335-2-40/A1)		P
DD.3	Information in manual (IEC 60335-2-40/A1 corr.1)		P
DD.4	Information on servicing (IEC 60335-2-40/A1)		P
DD.5	Repairs to sealed components (IEC 60335-2-40/A1)		P
DD.6	Repair to intrinsically safe components (IEC 60335-2-40/A1)		P
DD.7	Cabling (IEC 60335-2-40/A1)		P
DD.8	Detection of flammable refrigerants (IEC 60335-2-40/A1)		P
DD.9	Leak detection methods (IEC 60335-2-40/A1)		P
DD.10	Removal and evacuation (IEC 60335-2-40/A1)		P
DD.11	Charging procedures (IEC 60335-2-40/A1)		P
DD.12	Decommissioning (IEC 60335-2-40/A1)		P
DD.13	Labelling (IEC 60335-2-40/A1)		P
DD.14	Recovery (IEC 60335-2-40/A1)		P

IEC 60335-2-40			
Clause	Requirement + Test	Result - Remark	Verdict

EE	ANNEX EE (NORMATIVE) (IEC/EN 60335-2-40/A1) PRESSURE TESTS		--
EE.1	General (IEC 60335-2-40/A1)		P
EE.2	Pressure test value determined under testing carried out in clause 11 (IEC 60335-2-40/A1)		P
EE.3	Pressure test value determined under testing carried out in clause 19 (IEC 60335-2-40/A1)		P
EE.4	Pressure test value determined under testing carried out under standstill conditions (IEC 60335-2-40/A1)		P
EE.5	Fatigue test option for Clauses EE.1 and EE.4.1 (IEC 60335-2-40/A1)		N/A

FF	ANNEX FF (NORMATIVE) (IEC/EN 60335-2-40/A1) LEAK SIMULATION TESTS		--
FF.1	General (IEC 60335-2-40/A1)		N/A
FF.2	Test methods (IEC 60335-2-40/A1 corr.1)		N/A

GG	ANNEX GG (NORMATIVE) (IEC/EN 60335-2-40/A1) CHARGE LIMITS, VENTILATION REQUIREMENTS AND REQUIREMENTS FOR SECONDARY CIRCUITS		--
GG.1	Requirements for charge limits in ventilated areas (IEC 60335-2-40/A1 Corr.1)		P
GG.2	Requirements for charge limits in unventilated areas (IEC 60335-2-40/A1 Corr.1)		P
GG.3	Requirements for charge limits in areas with mechanical ventilation (IEC 60335-2-40/A1)		P
GG.4	Requirements for mechanical ventilation within the appliance enclosure (IEC 60335-2-40/A1)		N/A
GG.5	Requirements for mechanical ventilation for rooms complying with ISO 5149 (IEC 60335-2-40/A1)		N/A
GG.6	Requirements for refrigeration systems employing secondary heat exchangers (IEC 60335-2-40/A1 Corr.1)		N/A
GG.7	The appliance shall then be tested with a maximum water flow under the conditions described in g) (IEC 60335-2-40/A1)		N/A

## IEC 60335-2-40

10.1	TABLE: Power input deviation					P
Input deviation of/at:	P rated (W)	P measured (W)	$\Delta P$	Required $\Delta P$	Remark	
Model A equipped with indoor fan motor ZKFP-20-8-6(Welling) and outdoor fan motor ZKFN-20-8-1 (Welling).						
230 V, 50 Hz	2150	1487	-30,8%	+15 %	Cooling mode	
230 V, 50 Hz	2150	1277	-40,6%	+15 %	Heating mode	
Model A equipped with indoor fan motor ZKFP-20-8-6(Tongda) and outdoor fan motor ZKFN-20-8-1 (Tongda).						
230 V, 50 Hz	2150	1382	-35,7%	+15 %	Cooling mode	
230 V, 50 Hz	2150	1353	-37,1%	+15 %	Heating mode	
Model A equipped with indoor fan motor ZKFP-20-8-6(Sanjiang) and outdoor fan motor ZKFN-20-8-1 (Broad-Ocean).						
230 V, 50 Hz	2150	1378	-35,9%	+15 %	Cooling mode	
230 V, 50 Hz	2150	1252	-41,8%	+15 %	Heating mode	
Model B equipped with indoor fan motor ZKFP-13-8-4(Welling) outdoor fan motor ZKFN-34-10-1(Welling).						
230 V, 50 Hz	2150	1253	-41,7%	+15 %	Cooling mode	
230 V, 50 Hz	2150	1027	-52,2%	+15 %	Heating mode	
Model B equipped with indoor fan motor ZKFP-13-8-4(Sanjiang) outdoor fan motor ZKFN-34-10-1 (Shibaura).						
230 V, 50 Hz	2150	1173	-45,4%	+15 %	Cooling mode	
230 V, 50 Hz	2150	1016	-52,7%	+15 %	Heating mode	
Model B equipped with indoor fan motor ZKFP-13-8-4(Tongda) outdoor fan motor ZKFN-34-10-1 (Tongda).						
230 V, 50 Hz	2150	1157	-46,2%	+15 %	Cooling mode	
230 V, 50 Hz	2150	1066	-50,4%	+15 %	Heating mode	
Model C equipped with indoor fan motor ZKFP-13-8-4(Welling) outdoor fan motor ZKFN-20-8-1(Welling).						
230 V, 50 Hz	2150	1470	-31,6%	+15 %	Cooling mode	
230 V, 50 Hz	2150	1082	-49,7%	+15 %	Heating mode	
Model C equipped with indoor fan motor ZKFP-13-8-4(Sanjiang) outdoor fan motor ZKFN-20-8-1(Broad-Ocean).						
230 V, 50 Hz	2150	1408	-34,5%	+15 %	Cooling mode	
230 V, 50 Hz	2150	1166	-45,8%	+15 %	Heating mode	
Model C equipped with indoor fan motor ZKFP-13-8-4(Tongda) outdoor fan motor ZKFN-20-8-1(Tongda).						
230 V, 50 Hz	2150	1378	-35,9%	+15 %	Cooling mode	
230 V, 50 Hz	2150	1090	-49,3%	+15 %	Heating mode	
Model D equipped with indoor fan motor ZKFP-30-8-3 (Welling) outdoor fan motor ZKFN-34-10-1(Welling).						
230 V, 50 Hz	2500	2308	-7,7%	+15 %	Cooling mode	

IEC 60335-2-40					
230 V, 50 Hz	2500	1901	-24,0%	+15 %	Heating mode
Model D equipped with indoor fan motor ZKFP-30-8-3 (Shibaura) outdoor fan motor ZKFN-34-10-1(Shibaura).					
230 V, 50 Hz	2500	2084	-16,6%	+15 %	Cooling mode
230 V, 50 Hz	2500	1820	-27,2%	+15 %	Heating mode
Model D equipped with indoor fan motor ZKFP-30-8-3 (Broad-Ocean) outdoor fan motor ZKFN-34-10-1 (Tongda).					
230 V, 50 Hz	2500	2155	-13,8%	+15 %	Cooling mode
230 V, 50 Hz	2500	1722	-31,1%	+15 %	Heating mode
Model E equipped with indoor fan motor ZKFP-58-8-1(Broad-Ocean) outdoor fan motor ZKFN-80-8-3 (Broad-Ocean).					
230 V, 50 Hz	3700	3299	-10,8%	+15 %	Cooling mode
230 V, 50 Hz	3700	3535	-4,5%	+15 %	Heating mode
Model E equipped with indoor fan motor ZKFP-58-8-1(Shibaura) outdoor fan motor ZKFN-80-8-3 (Tongda).					
230 V, 50 Hz	3700	2965	-19,9%	+15 %	Cooling mode
230 V, 50 Hz	3700	3401	-8,1%	+15 %	Heating mode
Model E equipped with indoor fan motor ZKFP-58-8-1(Shibaura) outdoor fan motor ZKFN-80-8-3 (Welling).					
230 V, 50 Hz	3700	2940	-20,5%	+15 %	Cooling mode
230 V, 50 Hz	3700	3473	-6,1%	+15 %	Heating mode
Model F equipped with indoor fan motor ZKFP-13-8-4(Welling) outdoor fan motor ZKFN-34-10-1(Welling).					
230 V, 50 Hz	2150	1169	-45,6%	+15 %	Cooling mode
230 V, 50 Hz	2150	1073	-50,1%	+15 %	Heating mode
Model E equipped with alternative indoor fan motor ZKFP-58-8-1 (Welling).					
230 V, 50 Hz	3700	1369,8	-63,0%	+15 %	Cooling mode
230 V, 50 Hz	3700	1253,9	-66,1%	+15 %	Heating mode
Model H equipped with indoor fan motor (Welling) and outdoor fan motor (Welling).					
230 V, 50 Hz	2200	1140	-48,2%	+15 %	Cooling mode
230 V, 50 Hz	2200	1298	-41,0%	+15 %	Heating mode
Model H equipped with indoor fan motor (Sanjiang) and outdoor fan motor (Broad-Ocean).					
230 V, 50 Hz	2200	1138	-48,3%	+15 %	Cooling mode
230 V, 50 Hz	2200	1283	-41,7%	+15 %	Heating mode
Model H equipped with indoor fan motor (Tongda) and outdoor fan motor (Tongda).					
230 V, 50 Hz	2200	1127	-48,8%	+15 %	Cooling mode
230 V, 50 Hz	2200	1164	-47,1%	+15 %	Heating mode

## IEC 60335-2-40

Model H equipped with outdoor fan motor (Nidec).					
230 V, 50 Hz	2200	1062	-51,7%	+15 %	Cooling mode
230 V, 50 Hz	2200	977	-55,6%	+15 %	Heating mode
Model C equipped with indoor fan motor ZKFP-13-8-4 (Shibaura) and outdoor fan motor ZKFN-20-8-1 (JEAMO)					
230 V, 50 Hz	2150	843	-60,8 %	+15 %	Cooling mode
230 V, 50 Hz	2150	623	-71,0 %	+15 %	Heating mode
Model C equipped with indoor fan motor ZKFP-13-8-4 (Wolong) and outdoor fan motor ZKFN-20-8-1 (JEAMO)					
230 V, 50 Hz	2150	957	-55,5 %	+15 %	Cooling mode
230 V, 50 Hz	2150	626	-70,9 %	+15 %	Heating mode
Supplementary information:					

10.2	TABLE: Current deviation					P
Current deviation of/at:	I rated (A)	I measured (A)	$\Delta I$	Required $\Delta I$	Remark	
Model A equipped with indoor fan motor ZKFP-20-8-6(Welling) and outdoor fan motor ZKFN-20-8-1 (Welling).						
230 V, 50 Hz	10,0	6,51	-34,9%	+15 %	Cooling mode	
230 V, 50 Hz	10,0	5,63	-43,7%	+15 %	Heating mode	
Model A equipped with indoor fan motor ZKFP-20-8-6(Tongda) and outdoor fan motor ZKFN-20-8-1 (Tongda).						
230 V, 50 Hz	10,0	6,07	-39,3%	+15 %	Cooling mode	
230 V, 50 Hz	10,0	5,94	-40,6%	+15 %	Heating mode	
Model A equipped with indoor fan motor ZKFP-20-8-6(Sanjiang) and outdoor fan motor ZKFN-20-8-1 (Broad-Ocean).						
230 V, 50 Hz	10,0	6,05	-39,5%	+15 %	Cooling mode	
230 V, 50 Hz	10,0	5,50	-45,0%	+15 %	Heating mode	
Model B equipped with indoor fan motor ZKFP-13-8-4(Welling) outdoor fan motor ZKFN-34-10-1(Welling).						
230 V, 50 Hz	10,0	5,50	-45,0%	+15 %	Cooling mode	
230 V, 50 Hz	10,0	4,52	-54,8%	+15 %	Heating mode	
Model B equipped with indoor fan motor ZKFP-13-8-4(Sanjiang) outdoor fan motor ZKFN-34-10-1 (Shibaura).						
230 V, 50 Hz	10,0	5,14	-48,6%	+15 %	Cooling mode	
230 V, 50 Hz	10,0	4,45	-55,5%	+15 %	Heating mode	
Model B equipped with indoor fan motor ZKFP-13-8-4(Tongda) outdoor fan motor ZKFN-34-10-1 (Tongda).						
230 V, 50 Hz	10,0	5,07	-49,3%	+15 %	Cooling mode	
230 V, 50 Hz	10,0	4,67	-53,3%	+15 %	Heating mode	

## IEC 60335-2-40

Model C equipped with indoor fan motor ZKFP-13-8-4(Welling) outdoor fan motor ZKFN-20-8-1(Welling).					
230 V, 50 Hz	10,0	6,43	-35,7%	+15 %	Cooling mode
230 V, 50 Hz	10,0	4,76	-52,4%	+15 %	Heating mode
Model C equipped with indoor fan motor ZKFP-13-8-4(Sanjiang) outdoor fan motor ZKFN-20-8-1(Broad-Ocean).					
230 V, 50 Hz	10,0	6,16	-38,4%	+15 %	Cooling mode
230 V, 50 Hz	10,0	5,10	-49,0%	+15 %	Heating mode
Model C equipped with indoor fan motor ZKFP-13-8-4(Tongda) outdoor fan motor ZKFN-20-8-1(Tongda).					
230 V, 50 Hz	10,0	6,03	-39,7%	+15 %	Cooling mode
230 V, 50 Hz	10,0	4,77	-52,3%	+15 %	Heating mode
Model D equipped with indoor fan motor ZKFP-30-8-3 (Welling) outdoor fan motor ZKFN-34-10-1(Welling).					
230 V, 50 Hz	13,0	10,1	-22,3%	+15 %	Cooling mode
230 V, 50 Hz	13,0	8,3	-36,2%	+15 %	Heating mode
Model D equipped with indoor fan motor ZKFP-30-8-3 (Shibaura) outdoor fan motor ZKFN-34-10-1(Shibaura).					
230 V, 50 Hz	13,0	9,3	-28,5 %	+15 %	Cooling mode
230 V, 50 Hz	13,0	8,0	-38,5 %	+15 %	Heating mode
Model D equipped with indoor fan motor ZKFP-30-8-3 (Broad-Ocean) outdoor fan motor ZKFN-34-10-1 (Tongda).					
230 V, 50 Hz	13,0	9,4	-27,7 %	+15 %	Cooling mode
230 V, 50 Hz	13,0	7,5	-42,3 %	+15 %	Heating mode
Model E equipped with indoor fan motor ZKFP-58-8-1(Broad-Ocean) outdoor fan motor ZKFN-80-8-3 (Broad-Ocean).					
230 V, 50 Hz	19,0	14,38	-24,3%	+15 %	Cooling mode
230 V, 50 Hz	19,0	15,47	-18,6%	+15 %	Heating mode
Model E equipped with indoor fan motor ZKFP-58-8-1(Shibaura) outdoor fan motor ZKFN-80-8-3 (Tongda).					
230 V, 50 Hz	19,0	12,93	-31,9%	+15 %	Cooling mode
230 V, 50 Hz	19,0	14,82	-22,0%	+15 %	Heating mode
Model E equipped with indoor fan motor ZKFP-58-8-1(Shibaura) outdoor fan motor ZKFN-80-8-3 (Welling).					
230 V, 50 Hz	19,0	12,83	-32,5%	+15 %	Cooling mode
230 V, 50 Hz	19,0	15,14	-20,3%	+15 %	Heating mode
Model F equipped with indoor fan motor ZKFP-13-8-4(Welling) outdoor fan motor ZKFN-34-10-1(Welling).					
230 V, 50 Hz	10,0	5,18	-48,2%	+15 %	Cooling mode
230 V, 50 Hz	10,0	4,76	-52,4%	+15 %	Heating mode
Model E equipped with alternative indoor fan motor ZKFP-58-8-1 (Welling).					

<b>IEC 60335-2-40</b>					
230 V, 50 Hz	19,0	6,00	-68,4%	+15 %	Cooling mode
230 V, 50 Hz	19,0	5,50	-71,1%	+15 %	Heating mode
Model H equipped with indoor fan motor (Welling) and outdoor fan motor (Welling).					
230 V, 50 Hz	10,5	5,20	-50,5%	+15 %	Cooling mode
230 V, 50 Hz	10,5	5,80	-44,8%	+15 %	Heating mode
Model H equipped with indoor fan motor (Sanjiang) and outdoor fan motor (Broad-Ocean).					
230 V, 50 Hz	10,5	5,10	-51,4%	+15 %	Cooling mode
230 V, 50 Hz	10,5	5,80	-44,8%	+15 %	Heating mode
Model H equipped with indoor fan motor (Tongda) and outdoor fan motor (Tongda).					
230 V, 50 Hz	10,5	5,10	-51,4%	+15 %	Cooling mode
230 V, 50 Hz	10,5	5,30	-49,5%	+15 %	Heating mode
Model H equipped with outdoor fan motor (Nidec).					
230 V, 50 Hz	10,5	4,90	-53,3%	+15 %	Cooling mode
230 V, 50 Hz	10,5	4,50	-57,1%	+15 %	Heating mode
Model C equipped with indoor fan motor ZKFP-13-8-4 (Shibaura) and outdoor fan motor ZKFN-20-8-1 (JEAMO)					
230 V, 50 Hz	10,0	3,81	-61,9 %	+15 %	Cooling mode
230 V, 50 Hz	10,0	2,84	-71,6 %	+15 %	Heating mode
Model C equipped with indoor fan motor ZKFP-13-8-4 (Wolong) and outdoor fan motor ZKFN-20-8-1 (JEAMO)					
230 V, 50 Hz	10,0	4,30	-57,0 %	+15 %	Cooling mode
230 V, 50 Hz	10,0	2,86	-71,4 %	+15 %	Heating mode
Supplementary information:					

## IEC 60335-2-40

<b>11.8-1</b>	<b>TABLE: Heating test</b> Model A equipped with indoor fan motor ZKFP-20-8-6(Welling) and outdoor fan motor ZKFN-20-8-1 (Welling).		P
	Test voltage (V) .....	1,06 x 240 V = 254,4 V	—
	Ambient (°C) .....	See supplementary information	—
Thermocouple locations	Max. temperature measured, T (°C)		Max. temperature limit, T (°C)
	Cooling mode	Heating mode	
<b>Indoor unit</b>			
Indoor fan motor	36,0	38,3	105 (Class E)
Relay	40,3	39,5	T70
Terminal block	33,9	33,1	85/ for cl. 30
PCB	32,1	30,7	140
Supply cord	32,6	31,3	75
Air outlet	18,7	53,0	90
Transformer	46,4	45,9	110 (Class B)
X2 capacitor	39,1	38,3	T85
Varistor	37,1	36,0	T85
Step motor	31,6	32,3	105 (Class E)
Test corner	33,1	31,2	90
Enclosure	33,1	31,0	85/ for cl. 30
Anion generator	31,5	31,4	Ref.
<b>Outdoor unit</b>			
Motor compressor (top)	97,6	96,0	150
Refrigerant pipe	98,7	97,4	150
X2 capacitor	60,5	29,9	T85
Relay	57,1	29,6	T70
Outdoor fan motor	73,2	31,9	105 (Class E)
Electrolytic capacitor	57,4	30,6	T105
IPM	74,6	39,7	Ref.
Bridge rectifier	77,0	44,2	Ref.
Terminal block	42,2	12,8	85/ for cl. 30
4-way valve	56,6	49,7	110 (Class B)
Internal wire to compressor	86,8	78,9	T105

## IEC 60335-2-40

PCB	55,0	23,8	145
Interconnection cord	51,3	24,3	75
Enclosure	50,6	25,6	85/ for cl. 30
Transformer	54,2	27,2	110 (Class B)
Varistor	56,0	25,9	T85
Test corner	50,9	22,6	90

**Supplementary information:**

**Cooling mode:** Indoor unit: DB 35 °C, WB: 23 °C, outdoor unit: DB 50 °C, WB: 32 °C;

**Heating mode:** Indoor unit: DB 30 °C, WB: 19 °C, outdoor unit: DB 30 °C, WB: 19 °C

The alternative components with the appliance were also conducted; the most unfavourable test results were recorded.

<b>11.8-1</b>	<b>TABLE: Heating test, resistance method</b>						N/A
	Test voltage (V) .....				---	---	---
	Ambient, t1 (°C) .....				---	---	---
	Ambient, t2 (°C) .....				---	---	---
Temperature rise of winding	R1 (Ω)		R2 (Ω)		T (°C)	Max. T (°C)	Insulation class
	Main	Sub	Main	Sub			

**Supplementary information:**

<b>11.8-2</b>	<b>TABLE: Heating test</b> Model A equipped with indoor fan motor ZKFP-20-8-6(Tongda) and outdoor fan motor ZKFN-20-8-1 (Tongda).						P
	Test voltage (V) .....				1,06 x 240 V = 254,4 V	---	---
	Ambient (°C) .....				See supplementary information	---	---
Thermocouple locations	Max. temperature measured, T (°C)				Max. temperature limit, T (°C)		
	Cooling mode		Heating mode				
<b>Indoor unit</b>							
Indoor fan motor	35,8	37,9	105 (Class E)				
Relay	41,4	40,6	T70				
Terminal block	33,4	32,1	85/ for cl. 30				
PCB	32,4	30,8	140				
Supply cord	33,1	31,5	75				
Air outlet	19,4	53,3	90				
Transformer	48,8	49,7	110 (Class B)				
X2 capacitor	41,5	41,2	T85				

## IEC 60335-2-40

Varistor	36,2	35,2	T85
Step motor	42,3	41,4	105 (Class E)
Test corner	30,1	31,1	90
Enclosure	33,0	31,2	85/ for cl. 30
Anion generator	31,6	33,4	Ref.
<b>Outdoor unit</b>			
Motor compressor (top)	83,7	81,2	150
Refrigerant pipe	78,8	73,3	150
X2 capacitor	52,4	25,6	T85
Relay	54,9	27,3	T70
Outdoor fan motor	71,4	30,8	105 (Class E)
Electrolytic capacitor	54,3	27,7	T105
IPM	67,8	36,0	Ref.
Bridge rectifier	70,9	40,5	Ref.
Terminal block	33,7	35,8	85/ for cl. 30
4-way valve	57,1	56,8	110 (Class B)
Internal wire to compressor	75,0	65,2	T105
PCB	52,5	23,2	145
Interconnection cord	50,8	23,8	75
Enclosure	50,5	24,5	85/ for cl. 30
Transformer	53,4	26,5	110 (Class B)
Varistor	66,6	35,1	T85
Test corner	51,5	23,4	90

**Supplementary information:**

**Cooling mode:** Indoor unit: DB 35 °C, WB: 23 °C, outdoor unit: DB 50 °C, WB: 32 °C;

**Heating mode:** Indoor unit: DB 30 °C, WB: 19 °C, outdoor unit: DB 30 °C, WB: 19 °C

The alternative components with the appliance were also conducted; the most unfavourable test results were recorded.

<b>11.8-2</b>	<b>TABLE: Heating test, resistance method</b>				N/A
	Test voltage (V) .....	:	---		—
	Ambient, t1 (°C) .....	:	---		—
	Ambient, t2 (°C) .....	:	---		—
Temperature rise of winding	R1 (Ω)	R2 (Ω)	T (°C)	Max. T	Insulation

## IEC 60335-2-40

	Main	Sub	Main	Sub		(°C)	class
Supplementary information:							

11.8-3	TABLE: Heating test Model A equipped with indoor fan motor ZKFP-20-8-6(Sanjiang) and outdoor fan motor ZKFN-20-8-1 (Broad-Ocean).			P
	Test voltage (V) .....	1,06 x 240 V = 254,4 V		—
	Ambient (°C) .....	See supplementary information		—
Thermocouple locations	Max. temperature measured, T (°C)		Max. temperature limit, T (°C)	
	Cooling mode	Heating mode		
<b>Indoor unit</b>				
Indoor fan motor	36,1	38,0	105 (Class E)	
Relay	41,4	40,8	T70	
Terminal block	33,1	32,3	85/ for cl. 30	
PCB	32,3	31,0	140	
Supply cord	32,8	31,8	75	
Air outlet	18,5	53,7	90	
Transformer	49,7	49,7	110 (Class B)	
X2 capacitor	41,6	41,3	T85	
Varistor	36,2	35,2	T85	
Step motor	42,1	41,7	105 (Class E)	
Test corner	32,9	31,3	90	
Enclosure	32,9	31,3	85/ for cl. 30	
Anion generator	31,5	31,8	Ref.	
<b>Outdoor unit</b>				
Motor compressor (top)	81,0	81,2	150	
Refrigerant pipe	70,4	71,2	150	
X2 capacitor	52,6	25,8	T85	
Relay	54,8	27,2	T70	
Outdoor fan motor	66,8	28,3	105 (Class E)	
Electrolytic capacitor	53,7	27,8	T105	
IPM	69,5	37,8	Ref.	
Bridge rectifier	70,5	42,6	Ref.	

## IEC 60335-2-40

Terminal block	51,9	25,8	85/ for cl. 30
4-way valve	56,9	59,3	110 (Class B)
Internal wire to compressor	73,3	64,9	T105
PCB	52,9	22,9	145
Interconnection cord	50,9	23,9	75
Enclosure	50,6	24,3	85/ for cl. 30
Transformer	52,9	26,7	110 (Class B)
Varistor	55,9	38,2	T85
Test corner	51,1	23,4	90

**Supplementary information:**

**Cooling mode:** Indoor unit: DB 35 °C, WB: 23 °C, outdoor unit: DB 50 °C, WB: 32 °C;

**Heating mode:** Indoor unit: DB 30 °C, WB: 19 °C, outdoor unit: DB 30 °C, WB: 19 °C

The alternative components with the appliance were also conducted; the most unfavourable test results were recorded.

<b>11.8-3</b>	<b>TABLE: Heating test, resistance method</b>					N/A	
	Test voltage (V) .....	---			---		
	Ambient, t1 (°C) .....	---			---		
	Ambient, t2 (°C) .....	---			---		
Temperature rise of winding	R1 (Ω)		R2 (Ω)		T (°C)	Max. T (°C)	Insulation class
	Main	Sub	Main	Sub			

Supplementary information:

<b>11.8-4</b>	<b>TABLE: Heating test</b> Model B equipped with indoor fan motor ZKFP-13-8-4(Welling) outdoor fan motor ZKFN-34-10-1(Welling).					P
	Test voltage (V) .....	1,06 x 240 V = 254,4 V			---	
	Ambient (°C) .....	See supplementary information			---	
Thermocouple locations	Max. temperature measured, T (°C)				Max. temperature limit, T (°C)	
	Cooling mode		Heating mode			
<b>Indoor unit</b>						
Indoor fan motor	34,9	34,7			105 (Class E)	
Relay	40,7	39,4			T70	
Terminal block	33,6	31,5			85/ for cl. 30	
PCB	36,6	34,6			140	
Supply cord	33,3	30,9			75	

<b>IEC 60335-2-40</b>			
Air outlet	18,6	48,1	90
Transformer	48,5	47,5	110 (Class B)
X2 capacitor	45,3	43,9	T85
Varistor	37,9	36,5	T85
Step motor	39,6	37,0	105 (Class E)
Test corner	32,2	29,4	90
Enclosure	32,2	29,4	85/ for cl. 30
Anion generator	39,1	29,8	Ref.
<b>Outdoor unit</b>			
Motor compressor (top)	91,3	71,2	150
Refrigerant pipe	97,2	77,5	150
X2 capacitor	55,7	27,4	T85
Relay	52,0	29,0	T70
Outdoor fan motor	61,6	24,9	105 (Class E)
Electrolytic capacitor	56,6	31,0	T105
IPM	65,9	33,7	Ref.
Bridge rectifier	65,4	34,2	Ref.
Terminal block	50,4	25,3	85/ for cl. 30
4-way valve	52,9	70,5	110 (Class B)
Internal wire to compressor	75,0	52,9	T105
PCB	52,1	25,4	145
Interconnection cord	49,7	24,8	75
Enclosure	50,4	26,3	85/ for cl. 30
Transformer	56,6	32,5	110 (Class B)
Varistor	51,5	27,8	T85
Test corner	52,4	25,3	90
<b>Supplementary information:</b>			
<b>Cooling mode:</b> Indoor unit: DB 35 °C, WB: 23 °C, outdoor unit: DB 50 °C, WB: 32 °C;			
<b>Heating mode:</b> Indoor unit: DB 30 °C, WB: 19 °C, outdoor unit: DB 30 °C, WB: 19 °C			
The alternative components with the appliance were also conducted; the most unfavourable test results were recorded.			
<b>11.8-4</b>	<b>TABLE: Heating test, resistance method</b>		N/A
	Test voltage (V) .....	---	—

## IEC 60335-2-40

Ambient, t1 (°C) .....		---		---			
Ambient, t2 (°C) .....		---		---			
Temperature rise of winding	R1 (Ω)		R2 (Ω)		T (°C)	Max. T (°C)	Insulation class
	Main	Sub	Main	Sub			
Supplementary information:							

<b>11.8-5</b>	<b>TABLE: Heating test</b> Model B equipped with indoor fan motor ZKFP-13-8-4(Sanjiang) outdoor fan motor ZKFN-34-10-1 (Shibaura).			P
	Test voltage (V) .....	1,06 x 240 V = 254,4 V		---
	Ambient (°C) .....	See supplementary information		---
Thermocouple locations		Max. temperature measured, T (°C)		Max. temperature limit, T (°C)
		Cooling mode	Heating mode	
<b>Indoor unit</b>				
Indoor fan motor		34,8	34,5	105 (Class E)
Relay		38,6	36,8	T70
Terminal block		33,5	37,7	85/ for cl. 30
PCB		37,6	31,2	140
Supply cord		33,4	35,1	75
Air outlet		17,9	30,5	90
Transformer		46,7	48,2	110 (Class B)
X2 capacitor		32,2	45,5	T85
Varistor		36,8	29,1	T85
Step motor		34,6	35,0	105 (Class E)
Test corner		24,2	31,7	90
Enclosure		24,2	39,4	85/ for cl. 30
Anion generator		32,2	29,6	Ref.
<b>Outdoor unit</b>				
Motor compressor (top)		91,8	71,7	150
Refrigerant pipe		97,2	77,2	150
X2 capacitor		55,3	27,5	T85
Relay		52,7	29,1	T70
Outdoor fan motor		54,9	24,2	105 (Class E)
Electrolytic capacitor		56,5	30,2	T105

## IEC 60335-2-40

IPM	66,0	32,4	Ref.
Bridge rectifier	64,7	33,4	Ref.
Terminal block	51,1	25,3	85/ for cl. 30
4-way valve	52,2	61,9	110 (Class B)
Internal wire to compressor	75,7	54,4	T105
PCB	52,1	25,7	145
Interconnection cord	50,3	24,8	75
Enclosure	50,6	26,1	85/ for cl. 30
Transformer	57,3	32,4	110 (Class B)
Varistor	48,3	26,4	T85
Test corner	52,4	25,0	90

**Supplementary information:**

**Cooling mode:** Indoor unit: DB 35 °C, WB: 23 °C, outdoor unit: DB 50 °C, WB: 32 °C;

**Heating mode:** Indoor unit: DB 30 °C, WB: 19 °C, outdoor unit: DB 30 °C, WB: 19 °C

The alternative components with the appliance were also conducted; the most unfavourable test results were recorded.

<b>11.8-5</b>	<b>TABLE: Heating test, resistance method</b>						N/A
	Test voltage (V) .....		---		---		---
	Ambient, t1 (°C) .....		---		---		---
	Ambient, t2 (°C) .....		---		---		---
Temperature rise of winding	R1 (Ω)		R2 (Ω)		T (°C)	Max. T (°C)	Insulation class
	Main	Sub	Main	Sub			
Supplementary information:							

<b>11.8-6</b>	<b>TABLE: Heating test</b> Model B equipped with indoor fan motor ZKFP-13-8-4(Tongda) outdoor fan motor ZKFN-34-10-1 (Tongda).						P
	Test voltage (V) .....		1,06 x 240 V = 254,4 V		---		---
	Ambient (°C) .....		See supplementary information		---		---
Thermocouple locations	Max. temperature measured, T (°C)				Max. temperature limit, T (°C)		
	Cooling mode		Heating mode				
<b>Indoor unit</b>							
Indoor fan motor	34,5		34,6		105 (Class E)		
Relay	37,9		36,8		T70		
Terminal block	33,2		31,2		85/ for cl. 30		

## IEC 60335-2-40

PCB	37,0	35,1	140
Supply cord	33,4	30,6	75
Air outlet	18,6	48,2	90
Transformer	44,9	45,6	110 (Class B)
X2 capacitor	31,9	29,0	T85
Varistor	36,2	35,1	T85
Step motor	34,2	34,4	105 (Class E)
Test corner	34,2	39,4	90
Enclosure	24,1	39,4	85/ for cl. 30
Anion generator	31,9	29,6	Ref.
<b>Outdoor unit</b>			
Motor compressor (top)	91,4	71,6	150
Refrigerant pipe	96,6	77,1	150
X2 capacitor	55,0	27,3	T85
Relay	52,0	29,0	T70
Outdoor fan motor	62,0	25,3	105 (Class E)
Electrolytic capacitor	55,9	30,2	T105
IPM	65,0	32,3	Ref.
Bridge rectifier	66,2	33,3	Ref.
Terminal block	50,5	25,4	85/ for cl. 30
4-way valve	51,3	61,2	110 (Class B)
Internal wire to compressor	75,1	53,8	T105
PCB	51,6	25,6	145
Interconnection cord	49,7	24,8	75
Enclosure	50,0	25,9	85/ for cl. 30
Transformer	56,2	32,4	110 (Class B)
Varistor	49,7	26,7	T85
Test corner	52,0	24,9	90
<b>Supplementary information:</b>			
<b>Cooling mode:</b> Indoor unit: DB 35 °C, WB: 23 °C, outdoor unit: DB 50 °C, WB: 32 °C;			
<b>Heating mode:</b> Indoor unit: DB 30 °C, WB: 19 °C, outdoor unit: DB 30 °C, WB: 19 °C			
The alternative components with the appliance were also conducted; the most unfavourable test results were recorded.			

## IEC 60335-2-40

<b>11.8-6</b>	<b>TABLE: Heating test, resistance method</b>						N/A
	Test voltage (V) .....	---				---	
	Ambient, t1 (°C) .....	---				---	
	Ambient, t2 (°C) .....	---				---	
Temperature rise of winding	R1 (Ω)		R2 (Ω)		T (°C)	Max. T (°C)	Insulation class
	Main	Sub	Main	Sub			
Supplementary information:							

<b>11.8-7</b>	<b>TABLE: Heating test</b> Model C equipped with indoor fan motor ZKFP-13-8-4(Welling) outdoor fan motor ZKFN-20-8-1(Welling).						P
	Test voltage (V) .....	1,06 x 240 V = 254,4 V				---	
	Ambient (°C) .....	See supplementary information				---	
Thermocouple locations		Max. temperature measured, T (°C)		Max. temperature limit, T (°C)			
		Cooling mode	Heating mode				
<b>Indoor unit</b>							
Indoor fan motor		35,4		39,3		105 (Class E)	
Relay		42,8		44,2		T70	
Terminal block		32,8		33,1		85/ for cl. 30	
PCB		31,1		32,0		140	
Supply cord		21,0		50,8		75	
Air outlet		32,3		32,2		90	
Transformer		49,4		50,7		110 (Class B)	
X2 capacitor		41,0		41,6		T85	
Varistor		37,4		38,4		T85	
Step motor		43,8		43,7		105 (Class E)	
Test corner		31,6		31,0		90	
Enclosure		31,6		31,0		85/ for cl. 30	
Anion generator		31,1		31,4		Ref.	
<b>Outdoor unit</b>							
Motor compressor (top)		67,8		53,4		150	
Refrigerant pipe		88,6		85,3		150	
X2 capacitor		58,1		26,1		T85	
Relay		55,1		26,6		T70	

## IEC 60335-2-40

Outdoor fan motor	71,6	29,1	105 (Class E)
Electrolytic capacitor	55,6	27,1	T105
IPM	66,8	32,8	Ref.
Bridge rectifier	67,3	37,5	Ref.
Terminal block	52,2	23,2	85/ for cl. 30
4-way valve	54,6	35,2	110 (Class B)
Internal wire to compressor	76,3	66,1	T105
PCB	61,4	26,0	145
Interconnection cord	52,4	23,7	75
Enclosure	49,8	24,4	85/ for cl. 30
Transformer	54,2	25,5	110 (Class B)
Varistor	60,9	32,7	T85
Test corner	52,7	21,6	90

**Supplementary information:**

**Cooling mode:** Indoor unit: DB 35 °C, WB: 23 °C, outdoor unit: DB 50 °C, WB: 32 °C;

**Heating mode:** Indoor unit: DB 30 °C, WB: 19 °C, outdoor unit: DB 30 °C, WB: 19 °C

The alternative components with the appliance were also conducted; the most unfavourable test results were recorded.

<b>11.8-7</b>	<b>TABLE: Heating test, resistance method</b>					N/A	
	Test voltage (V) .....	---			---		
	Ambient, t1 (°C) .....	---			---		
	Ambient, t2 (°C) .....	---			---		
Temperature rise of winding	R1 (Ω)		R2 (Ω)		T (°C)	Max. T (°C)	Insulation class
	Main	Sub	Main	Sub			

Supplementary information:

<b>11.8-8</b>	<b>TABLE: Heating test</b> Model C equipped with indoor fan motor ZKFP-13-8-4(Sanjiang) outdoor fan motor ZKFN-20-8-1(Broad-Ocean).					P
	Test voltage (V) .....	1,06 x 240 V = 254,4 V			---	
	Ambient (°C) .....	See supplementary information			---	
Thermocouple locations	Max. temperature measured, T (°C)			Max. temperature limit, T (°C)		
	Cooling mode		Heating mode			
<b>Indoor unit</b>						
Indoor fan motor	35,0	39,7	105 (Class E)			

## IEC 60335-2-40

Relay	41,2	42,8	T70
Terminal block	32,4	32,8	85/ for cl. 30
PCB	31,3	31,6	140
Supply cord	32,0	51,5	75
Air outlet	21,0	32,3	90
Transformer	46,9	50,1	110 (Class B)
X2 capacitor	39,9	41,4	T85
Varistor	36,2	37,3	T85
Step motor	41,4	41,3	105 (Class E)
Test corner	31,7	31,0	90
Enclosure	31,7	31,0	85/ for cl. 30
Anion generator	30,9	33,8	Ref.
<b>Outdoor unit</b>			
Motor compressor (top)	67,2	52,5	150
Refrigerant pipe	88,1	84,0	150
X2 capacitor	56,9	25,1	T85
Relay	54,4	28,5	T70
Outdoor fan motor	70,3	28,5	105 (Class E)
Electrolytic capacitor	53,8	25,4	T105
IPM	64,2	30,9	Ref.
Bridge rectifier	64,6	35,2	Ref.
Terminal block	52,2	23,9	85/ for cl. 30
4-way valve	54,1	34,5	110 (Class B)
Internal wire to compressor	70,8	53,7	T105
PCB	60,0	25,8	145
Interconnection cord	52,9	24,8	75
Enclosure	49,8	25,2	85/ for cl. 30
Transformer	53,6	25,4	110 (Class B)
Varistor	59,3	32,9	T85
Test corner	52,5	21,9	90
<b>Supplementary information:</b>			
<b>Cooling mode:</b> Indoor unit: DB 35 °C, WB: 23 °C, outdoor unit: DB 50 °C, WB: 32 °C;			

## IEC 60335-2-40

**Heating mode:** Indoor unit: DB 30 °C, WB: 19 °C, outdoor unit: DB 30 °C, WB: 19 °C

The alternative components with the appliance were also conducted; the most unfavourable test results were recorded.

<b>11.8-8</b>	<b>TABLE: Heating test, resistance method</b>					N/A	
	Test voltage (V) .....	---			---		
	Ambient, t1 (°C) .....	---			---		
	Ambient, t2 (°C) .....	---			---		
Temperature rise of winding	R1 (Ω)		R2 (Ω)		T (°C)	Max. T (°C)	Insulation class
	Main	Sub	Main	Sub			
Supplementary information:							

<b>11.8-9</b>	<b>TABLE: Heating test</b> Model C equipped with indoor fan motor ZKFP-13-8-4(Tongda) outdoor fan motor ZKFN-20-8-1(Tongda).					P
	Test voltage (V) .....	1,06 x 240 V = 254,4 V			---	
	Ambient (°C) .....	See supplementary information			---	
Thermocouple locations		Max. temperature measured, T (°C)		Max. temperature limit, T (°C)		
		Cooling mode	Heating mode			
<b>Indoor unit</b>						
Indoor fan motor		34,9	39,4	105 (Class E)		
Relay		41,7	43,2	T70		
Terminal block		32,2	32,9	85/ for cl. 30		
PCB		31,0	31,7	140		
Supply cord		20,8	51,6	75		
Air outlet		31,9	32,4	90		
Transformer		48,4	50,3	110 (Class B)		
X2 capacitor		40,5	41,7	T85		
Varistor		36,4	37,5	T85		
Step motor		41,0	41,4	105 (Class E)		
Test corner		31,3	31,3	90		
Enclosure		31,3	31,3	85/ for cl. 30		
Anion generator		31,0	33,2	Ref.		
<b>Outdoor unit</b>						
Motor compressor (top)		63,9	84,0	150		
Refrigerant pipe		88,4	85,5	150		

## IEC 60335-2-40

X2 capacitor	56,3	25,7	T85
Relay	54,2	29,3	T70
Outdoor fan motor	70,1	28,8	105 (Class E)
Electrolytic capacitor	54,0	26,8	T105
IPM	64,7	32,1	Ref.
Bridge rectifier	65,1	36,8	Ref.
Terminal block	51,7	23,5	85/ for cl. 30
4-way valve	53,7	33,1	110 (Class B)
Internal wire to compressor	74,3	62,7	T105
PCB	60,3	25,6	145
Interconnection cord	52,2	24,0	75
Enclosure	49,6	24,6	85/ for cl. 30
Transformer	53,1	25,4	110 (Class B)
Varistor	60,0	30,2	T85
Test corner	52,3	22,1	90

**Supplementary information:**

**Cooling mode:** Indoor unit: DB 35 °C, WB: 23 °C, outdoor unit: DB 50 °C, WB: 32 °C;

**Heating mode:** Indoor unit: DB 30 °C, WB: 19 °C, outdoor unit: DB 30 °C, WB: 19 °C

The alternative components with the appliance were also conducted; the most unfavourable test results were recorded.

<b>11.8-9</b>	<b>TABLE: Heating test, resistance method</b>						N/A
	Test voltage (V) .....				---	---	
	Ambient, t1 (°C) .....				---	---	
	Ambient, t2 (°C) .....				---	---	
Temperature rise of winding	R1 (Ω)		R2 (Ω)		T (°C)	Max. T (°C)	Insulation class
	Main	Sub	Main	Sub			

Supplementary information:

<b>11.8-10</b>	<b>TABLE: Heating test</b> Model D equipped with indoor fan motor ZKFP-30-8-3 (Welling) outdoor fan motor ZKFN-34-10-1(Welling).						P
	Test voltage (V) .....				1,06 x 240 V = 254,4 V	---	
	Ambient (°C) .....				See supplementary information	---	
Thermocouple locations	Max. temperature measured, T (°C)				Max. temperature limit, T (°C)		
	Cooling mode		Heating mode				

## IEC 60335-2-40

<b>Indoor unit</b>			
Indoor fan motor	39,3	38,3	105 (Class E)
Relay	50,5	47,9	T70
Terminal block	32,6	32,2	85/ for cl. 30
PCB	33,7	33,4	140
Supply cord	33,0	31,6	75
Air outlet	21,6	46,6	90
Transformer	47,3	47,5	110 (Class B)
X2 capacitor	40,2	40,2	T85
Varistor	35,6	36,1	T85
Step motor	31,3	31,3	105 (Class E)
Test corner	31,2	31,0	90
Enclosure	32,1	31,0	85/ for cl. 30
Anion generator	35,6	30,5	Ref.
<b>Outdoor unit</b>			
Motor compressor (top)	71,3	64,5	150
Refrigerant pipe	81,6	74,1	150
X2 capacitor	60,3	26,9	T85
Relay	54,3	26,6	T70
Outdoor fan motor	70,1	24,6	105 (Class E)
Electrolytic capacitor	55,3	27,5	T105
IPM	73,4	36,8	Ref.
Bridge rectifier	65,9	35,1	Ref.
Terminal block	55,7	24,7	85/ for cl. 30
4-way valve	56,4	62,8	110 (Class B)
Internal wire to compressor	63,8	45,5	T105
PCB	59,2	30,2	145
Interconnection cord	53,0	24,0	75
Enclosure	54,4	25,0	85/ for cl. 30
Transformer	52,7	24,9	110 (Class B)
Varistor	60,7	29,9	T85

## IEC 60335-2-40

Test corner	53,1	23,9	90				
<b>Supplementary information:</b>							
<b>Cooling mode:</b> Indoor unit: DB 35 °C, WB: 23 °C, outdoor unit: DB 50 °C, WB: 32 °C; <b>Heating mode:</b> Indoor unit: DB 30 °C, WB: 19 °C, outdoor unit: DB 30 °C, WB: 19 °C							
The alternative components with the appliance were also conducted; the most unfavourable test results were recorded.							
<b>11.8-10</b>	<b>TABLE: Heating test, resistance method</b>			N/A			
	Test voltage (V) .....	---	---	---			
	Ambient, t1 (°C) .....	---	---	---			
	Ambient, t2 (°C) .....	---	---	---			
Temperature rise of winding	R1 (Ω)		R2 (Ω)		T (°C)	Max. T (°C)	Insulation class
	Main	Sub	Main	Sub			
Supplementary information:							

<b>11.8-11</b>	<b>TABLE: Heating test Model D equipped with indoor fan motor ZKFP-30-8-3 (Shibaura) outdoor fan motor ZKFN-34-10-1 (Shibaura).</b>			P
	Test voltage (V) .....	1,06 x 240 V = 254,4 V		---
	Ambient (°C) .....	See supplementary information		---
Thermocouple locations		Max. temperature measured, T (°C)		Max. temperature limit, T (°C)
		Cooling mode	Heating mode	
<b>Indoor unit</b>				
Indoor fan motor	39,4	40,6	105 (Class E)	
Relay	48,9	50,4	T70	
Terminal block	32,8	32,2	85/ for cl. 30	
PCB	33,6	33,1	140	
Supply cord	33,0	30,0	75	
Air outlet	22,4	47,7	90	
Transformer	44,2	47,7	110 (Class B)	
X2 capacitor	39,9	40,1	T85	
Varistor	34,9	35,7	T85	
Step motor	31,7	31,2	105 (Class E)	
Test corner	32,0	31,0	90	
Enclosure	32,0	30,5	85/ for cl. 30	
Anion generator	31,8	31,0	Ref.	

## IEC 60335-2-40

<b>Outdoor unit</b>			
Motor compressor (top)	87,3	74,1	150
Refrigerant pipe	87,2	82,4	150
X2 capacitor	65,6	24,4	T85
Relay	60,0	27,4	T70
Outdoor fan motor	74,5	25,8	105 (Class E)
Electrolytic capacitor	60,9	28,6	T105
IPM	89,3	38,4	Ref.
Bridge rectifier	86,0	35,5	Ref.
Terminal block	60,9	29,2	85/ for cl. 30
4-way valve	63,1	61,8	110 (Class B)
Internal wire to compressor	69,5	53,3	T105
PCB	65,2	31,0	145
Interconnection cord	57,3	25,2	75
Enclosure	62,1	27,3	85/ for cl. 30
Transformer	57,3	25,9	110 (Class B)
Varistor	65,8	32,5	T85
Test corner	58,3	24,1	90

**Supplementary information:**

**Cooling mode:** Indoor unit: DB 35 °C, WB: 23 °C, outdoor unit: DB 50 °C, WB: 32 °C;

**Heating mode:** Indoor unit: DB 30 °C, WB: 19 °C, outdoor unit: DB 30 °C, WB: 19 °C

The alternative components with the appliance were also conducted; the most unfavourable test results were recorded.

11.8-11	<b>TABLE: Heating test, resistance method</b>						N/A
	Test voltage (V) .....		---		---		—
	Ambient, t1 (°C) .....		---		---		—
	Ambient, t2 (°C) .....		---		---		—
Temperature rise of winding	R1 (Ω)		R2 (Ω)		T (°C)	Max. T (°C)	Insulation class
	Main	Sub	Main	Sub			

Supplementary information:

11.8-12	<b>TABLE: Heating test Model D equipped with indoor fan motor ZKFP-30-8-3 (Broad-Ocean) outdoor fan motor ZKFN-34-10-1 (Tongda).</b>		P
	Test voltage (V) .....		1,06 x 240 V = 254,4 V
			—

## IEC 60335-2-40

	Ambient (°C) .....	See supplementary information		—
Thermocouple locations	Max. temperature measured, T (°C)		Max. temperature limit, T (°C)	
	Cooling mode	Heating mode		
<b>Indoor unit</b>				
Indoor fan motor	38,0	38,2	105 (Class E)	
Relay	49,0	49,3	T70	
Terminal block	32,7	31,2	85/ for cl. 30	
PCB	33,6	32,2	140	
Supply cord	34,4	30,4	75	
Air outlet	22,8	46,5	90	
Transformer	44,8	47,1	110 (Class B)	
X2 capacitor	39,6	39,2	T85	
Varistor	35,1	34,8	T85	
Step motor	31,0	30,0	105 (Class E)	
Test corner	31,9	29,8	90	
Enclosure	31,9	29,8	85/ for cl. 30	
Anion generator	34,4	39,1	Ref.	
<b>Outdoor unit</b>				
Motor compressor (top)	74,6	67,8	150	
Refrigerant pipe	82,4	78,5	150	
X2 capacitor	55,8	28,6	T85	
Relay	53,6	25,4	T70	
Outdoor fan motor	68,3	22,4	105 (Class E)	
Electrolytic capacitor	56,6	29,1	T105	
IPM	72,4	37,1	Ref.	
Bridge rectifier	66,6	35,1	Ref.	
Terminal block	53,3	24,2	85/ for cl. 30	
4-way valve	56,2	67,9	110 (Class B)	
Internal wire to compressor	63,9	47,3	T105	
PCB	65,0	29,4	145	
Interconnection cord	51,6	23,2	75	
Enclosure	51,8	24,8	85/ for cl. 30	

**IEC 60335-2-40**

Transformer	57,6	29,7	110 (Class B)
Varistor	57,5	26,3	T85
Test corner	51,5	22,5	90

**Supplementary information:**

**Cooling mode:** Indoor unit: DB 35 °C, WB: 23 °C, outdoor unit: DB 50 °C, WB: 32 °C;

**Heating mode:** Indoor unit: DB 30 °C, WB: 19 °C, outdoor unit: DB 30 °C, WB: 19 °C

The alternative components with the appliance were also conducted; the most unfavourable test results were recorded.

<b>11.8-12</b>	<b>TABLE: Heating test, resistance method</b>					N/A	
	Test voltage (V) .....		---		---		
	Ambient, t1 (°C) .....		---		---		
	Ambient, t2 (°C) .....		---		---		
Temperature rise of winding	R1 (Ω)		R2 (Ω)		T (°C)	Max. T (°C)	Insulation class
	Main	Sub	Main	Sub			

Supplementary information:

<b>11.8-13</b>	<b>TABLE: Heating test</b> Model E equipped with indoor fan motor ZKFP-58-8-1(Broad-Ocean) outdoor fan motor ZKFN-80-8-3 (Broad-Ocean).					P
	Test voltage (V) .....		1,06 x 240 V = 254,4 V		---	
	Ambient (°C) .....		See supplementary information		---	
Thermocouple locations	Max. temperature measured, T (°C)			Max. temperature limit, T (°C)		
	Cooling mode		Heating mode			
<b>Indoor unit</b>						
Indoor fan motor	41,2	40,7	105 (Class E)			
Relay	41,4	40,6	T70			
Terminal block	33,0	31,9	85/ for cl. 30			
PCB	32,9	32,1	140			
Supply cord	32,2	31,3	75			
Air outlet	20,4	51,1	90			
Transformer	46,4	45,8	110 (Class B)			
X2 capacitor	46,2	45,9	T85			
Varistor	35,8	35,0	T85			
Step motor	41,6	40,7	105 (Class E)			
Test corner	27,5	38,4	90			

IEC 60335-2-40							
Enclosure	27,5	38,4	85/ for cl. 30				
Anion generator	31,6	31,7	Ref.				
<b>Outdoor unit</b>							
Motor compressor (top)	65,9	70,2	150				
Refrigerant pipe	65,2	73,1	150				
X2 capacitor	59,2	35,8	T85				
Relay	58,0	30,4	T70				
Outdoor fan motor	62,9	21,0	105 (Class E)				
Electrolytic capacitor	62,2	38,3	T105				
IPM	69,9	58,1	Ref.				
Bridge rectifier	66,4	54,2	Ref.				
Terminal block	55,1	27,3	85/ for cl. 30				
4-way valve	55,6	34,2	110 (Class B)				
Internal wire to compressor	64,8	53,9	T105				
PCB	52,1	23,0	145				
Interconnection cord	52,7	23,2	75				
Enclosure	51,5	23,7	85/ for cl. 30				
Transformer	62,1	37,3	110 (Class B)				
Varistor	23,7	37,9	T85				
Test corner	49,5	22,3	90				
<b>Supplementary information:</b>							
<b>Cooling mode:</b> Indoor unit: DB 35 °C, WB: 23 °C, outdoor unit: DB 50 °C, WB: 32 °C;							
<b>Heating mode:</b> Indoor unit: DB 30 °C, WB: 19 °C, outdoor unit: DB 30 °C, WB: 19 °C							
The alternative components with the appliance were also conducted; the most unfavourable test results were recorded.							
<b>11.8-13</b>	<b>TABLE: Heating test, resistance method</b>					N/A	
	Test voltage (V) .....	:	---		---		
	Ambient, t1 (°C) .....	:	---		---		
	Ambient, t2 (°C) .....	:	---		---		
Temperature rise of winding	R1 (Ω)		R2 (Ω)		T (°C)	Max. T (°C)	Insulation class
	Main	Sub	Main	Sub			
Supplementary information:							

## IEC 60335-2-40

<b>11.8-14</b>	<b>TABLE: Heating test</b> Model E equipped with indoor fan motor ZKFP-58-8-1 (Shibaura) outdoor fan motor ZKFN-80-8-3 (Tongda).		P
	Test voltage (V) .....	1,06 x 240 V = 254,4 V	—
	Ambient (°C) .....	See supplementary information	—
Thermocouple locations	Max. temperature measured, T (°C)		Max. temperature limit, T (°C)
	Cooling mode	Heating mode	
<b>Indoor unit</b>			
Indoor fan motor	39,0	38,7	105 (Class E)
Relay	44,4	43,7	T70
Terminal block	33,7	32,3	85/ for cl. 30
PCB	32,2	31,3	140
Supply cord	32,6	31,1	75
Air outlet	20,1	51,1	90
Transformer	45,9	46,3	110 (Class B)
X2 capacitor	45,8	46,1	T85
Varistor	37,4	37,0	T85
Step motor	42,2	41,2	105 (Class E)
Test corner	29,4	37,0	90
Enclosure	29,4	37,0	85/ for cl. 30
Anion generator	31,8	32,0	Ref.
<b>Outdoor unit</b>			
Motor compressor (top)	66,5	73,8	150
Refrigerant pipe	64,7	75,3	150
X2 capacitor	58,2	34,5	T85
Relay	58,0	31,1	T70
Outdoor fan motor	62,9	21,5	105 (Class E)
Electrolytic capacitor	59,7	35,0	T105
IPM	69,4	59,5	Ref.
Bridge rectifier	66,7	55,1	Ref.
Terminal block	55,0	27,6	85/ for cl. 30
4-way valve	56,0	36,8	110 (Class B)
Internal wire to compressor	64,1	56,2	T105

## IEC 60335-2-40

PCB	51,4	21,2	145
Interconnection cord	53,0	23,7	75
Enclosure	51,5	23,9	85/ for cl. 30
Transformer	64,9	39,5	110 (Class B)
Varistor	59,2	30,9	T85
Test corner	48,2	21,0	90

**Supplementary information:**

**Cooling mode:** Indoor unit: DB 35 °C, WB: 23 °C, outdoor unit: DB 50 °C, WB: 32 °C;

**Heating mode:** Indoor unit: DB 30 °C, WB: 19 °C, outdoor unit: DB 30 °C, WB: 19 °C

The alternative components with the appliance were also conducted; the most unfavourable test results were recorded.

<b>11.8-14</b>	<b>TABLE: Heating test, resistance method</b>						N/A
	Test voltage (V) .....				---	---	
	Ambient, t1 (°C) .....				---	---	
	Ambient, t2 (°C) .....				---	---	
Temperature rise of winding	R1 (Ω)		R2 (Ω)		T (°C)	Max. T (°C)	Insulation class
	Main	Sub	Main	Sub			

Supplementary information:

<b>11.8-15</b>	<b>TABLE: Heating test</b> Model E equipped with indoor fan motor ZKFP-58-8-1 (Shibaura) outdoor fan motor ZKFN-80-8-3 (Welling).						P
	Test voltage (V) .....				1,06 x 240 V = 254,4 V	---	
	Ambient (°C) .....				See supplementary information	---	
Thermocouple locations	Max. temperature measured, T (°C)				Max. temperature limit, T (°C)		
	Cooling mode		Heating mode				
<b>Indoor unit</b>							
Indoor fan motor	39,2	38,8			105 (Class E)		
Relay	43,4	43,1			T70		
Terminal block	33,2	32,0			85/ for cl. 30		
PCB	31,7	31,2			140		
Supply cord	32,2	30,9			75		
Air outlet	19,9	49,4			90		
Transformer	45,6	46,4			110 (Class B)		
X2 capacitor	45,7	46,6			T85		

## IEC 60335-2-40

Varistor	36,6	36,4	T85		
Step motor	41,5	41,1	105 (Class E)		
Test corner	29,0	36,3	90		
Enclosure	29,0	36,3	85/ for cl. 30		
Anion generator	31,3	31,9	Ref.		
<b>Outdoor unit</b>					
Motor compressor (top)	65,8	72,8	150		
Refrigerant pipe	64,5	74,7	150		
X2 capacitor	58,0	34,1	T85		
Relay	58,0	31,4	T70		
Outdoor fan motor	62,9	21,1	105 (Class E)		
Electrolytic capacitor	59,4	34,6	T105		
IPM	70,2	58,4	Ref.		
Bridge rectifier	65,6	55,8	Ref.		
Terminal block	55,4	27,0	85/ for cl. 30		
4-way valve	55,8	34,7	110 (Class B)		
Internal wire to compressor	64,3	55,1	T105		
PCB	50,8	21,5	145		
Interconnection cord	52,7	24,3	75		
Enclosure	51,5	24,0	85/ for cl. 30		
Transformer	65,3	39,1	110 (Class B)		
Varistor	32,6	31,8	T85		
Test corner	48,3	21,1	90		
<b>Supplementary information:</b>					
<b>Cooling mode:</b> Indoor unit: DB 35 °C, WB: 23 °C, outdoor unit: DB 50 °C, WB: 32 °C;					
<b>Heating mode:</b> Indoor unit: DB 30 °C, WB: 19 °C, outdoor unit: DB 30 °C, WB: 19 °C					
The alternative components with the appliance were also conducted; the most unfavourable test results were recorded.					
<b>11.8-15</b>	<b>TABLE: Heating test, resistance method</b>			N/A	
	Test voltage (V) .....	---	---	---	
	Ambient, t1 (°C) .....	---	---	---	
	Ambient, t2 (°C) .....	---	---	---	
Temperature rise of winding	R1 (Ω)	R2 (Ω)	T (°C)	Max. T	Insulation

## IEC 60335-2-40

	Main	Sub	Main	Sub		(°C)	class
Supplementary information:							

11.8-16	TABLE: Heating test Model F equipped with indoor fan motor ZKFP-13-8-4(Welling) outdoor fan motor ZKFN-34-10-1(Welling).			P
	Test voltage (V) .....	1,06 x 240 V = 254,4 V		—
	Ambient (°C) .....	See supplementary information		—
Thermocouple locations		Max. temperature measured, T (°C)		Max. temperature limit, T (°C)
		Cooling mode	Heating mode	
<b>Indoor unit</b>				
Indoor fan motor		37,4	36,7	105 (Class E)
Relay		50,9	48,4	T70
Terminal block		34,2	31,4	85/ for cl. 30
PCB		33,3	30,3	140
Supply cord		37,9	35,3	75
Air outlet		20,1	47,1	90
Transformer		44,6	42,4	110 (Class B)
X2 capacitor		39,4	36,5	T85
Varistor		38,0	35,5	T85
Step motor		33,2	39,5	105 (Class E)
Test corner		33,3	30,9	90
Enclosure		33,3	30,9	85/ for cl. 30
Anion generator		32,4	30,6	Ref.
<b>Outdoor unit</b>				
Motor compressor (top)		81,6	60,9	150
Refrigerant pipe		86,4	65,8	150
X2 capacitor		53,8	27,5	T85
Relay		52,0	28,2	T70
Outdoor fan motor		61,8	26,2	105 (Class E)
Electrolytic capacitor		52,9	27,5	T105
IPM		68,1	34,8	Ref.
Bridge rectifier		65,2	34,2	Ref.

## IEC 60335-2-40

Terminal block	50,2	24,6	85/ for cl. 30
4-way valve	52,1	39,2	110 (Class B)
Internal wire to compressor	57,2	33,2	T105
PCB	55,1	28,2	145
Interconnection cord	51,0	34,5	75
Enclosure	50,7	25,1	85/ for cl. 30
Transformer	56,0	30,9	110 (Class B)
Varistor	52,2	26,3	T85
Test corner	47,6	25,6	90

**Supplementary information:**

**Cooling mode:** Indoor unit: DB 35 °C, WB: 23 °C, outdoor unit: DB 50 °C, WB: 32 °C;

**Heating mode:** Indoor unit: DB 30 °C, WB: 19 °C, outdoor unit: DB 30 °C, WB: 19 °C

The alternative components with the appliance were also conducted; the most unfavourable test results were recorded.

<b>11.8-16</b>	<b>TABLE: Heating test, resistance method</b>					N/A	
	Test voltage (V) .....	---			---		
	Ambient, t1 (°C) .....	---			---		
	Ambient, t2 (°C) .....	---			---		
Temperature rise of winding	R1 (Ω)		R2 (Ω)		T (°C)	Max. T (°C)	Insulation class
	Main	Sub	Main	Sub			

Supplementary information:

<b>11.8-17</b>	<b>TABLE: Heating test Model E equipped with alternative indoor fan motor ZKFP-58-8-1 (Welling).</b>					P
	Test voltage (V) .....	1,06 x 240 V = 254,4 V			---	
	Ambient (°C) .....	See supplementary information			---	
Thermocouple locations	Max. temperature measured, T (°C)				Max. temperature limit, T (°C)	
	Cooling mode		Heating mode			
<b>Indoor unit</b>						
Indoor fan motor	35,2	31,4			150	
Relay	46,6	44,5			T70	
Terminal block	33,6	30,1			For cl.30.1 / 85	
PCB	34,1	31,0			145	
Power cord	33,0	29,2			75	

<b>IEC 60335-2-40</b>			
Air outlet	22,5	54,8	90
Transformer winding	45,2	41,3	110 (class B)
X2 capacitor	39,6	35,8	T85
Varistor	38,3	35,9	T85
Test corner	31,8	27,7	90
Step motor	31,2	27,9	105 (Class E)
<b>Outdoor unit</b>			
Discharge pipe	76,9	73,5	Ref.
Motor compressor, side	74,9	72,9	140
X2 capacitor	52,7	25,3	T85
Relay	54,8	28,7	T70
Outdoor fan motor	67,2	25,2	150
Electrolytic capacitor	58,3	37,4	Ref.
IPM	65,1	53,5	Ref.
Bridge rectifier	62,2	47,6	Ref.
Terminal block	52,5	25,1	85 / for cl.30.1
4-way valve	53,6	50,4	110 (Class B)
Internal wire to compressor	66,5	52,4	T105
PCB	63,2	43,1	145
Power cord	52,4	25,2	75
Enclosure	51,2	25,7	85
Transformer winding	56,8	34,3	110 (Class B)
Varistor	52,7	25,0	T85
Test corner	52,8	24,9	90
<b>Supplementary information:</b>			
<b>Cooling mode:</b> Indoor unit: DB 35 °C, WB: 23 °C, outdoor unit: DB 50 °C, WB: 32 °C;			
<b>Heating mode:</b> Indoor unit: DB 30 °C, WB: 19 °C, outdoor unit: DB 30 °C, WB: 19 °C			
The alternative components with the appliance were also conducted; the most unfavourable test results were recorded.			
<b>11.8-17</b>	<b>TABLE: Heating test, resistance method</b>		N/A
	Test voltage (V) .....	---	---
	Ambient, t1 (°C) .....	---	---
	Ambient, t2 (°C) .....	---	---

## IEC 60335-2-40

Temperature rise of winding	R1 ( $\Omega$ )		R2 ( $\Omega$ )		T ( $^{\circ}\text{C}$ )	Max. T ( $^{\circ}\text{C}$ )	Insulation class
	Main	Sub	Main	Sub			

Supplementary information:

11.8-18	TABLE: Heating test Model H equipped with indoor fan motor (Welling) and outdoor fan motor (Welling).			P
	Test voltage (V) .....	1,06 x 240 V = 254,4 V		—
	Ambient ( $^{\circ}\text{C}$ ) .....	See supplementary information		—
Thermocouple locations		Max. temperature measured, T ( $^{\circ}\text{C}$ )		Max. temperature limit, T ( $^{\circ}\text{C}$ )
		Cooling mode	Heating mode	
<b>Indoor unit</b>				
Indoor fan motor		33,2	31,7	105 (Class E)
Relay		44,0	42,7	T70
Terminal block		33,7	31,5	85/ for cl. 30
PCB		32,2	29,4	140
Supply cord		32,4	30,1	75
Air outlet		21,6	50,2	90
Transformer		48,8	47,7	110 (Class B)
X2 capacitor		42,1	40,1	T85
Varistor		38,9	37,7	T85
Step motor		31,9	29,9	105 (Class E)
Test corner		32,3	29,3	90
Enclosure		32,3	29,0	85/ for cl. 30
<b>Outdoor unit</b>				
Motor compressor (top)		77,5	70,3	150
Refrigerant pipe		84,8	80,2	150
X2 capacitor		54,0	30,7	T85
Relay		50,6	26,1	T70
Outdoor fan motor		58,7	22,9	105 (Class E)
Electrolytic capacitor		53,1	31,2	T105
IPM		62,8	34,8	Ref.
Bridge rectifier		64,8	36,9	Ref.

## IEC 60335-2-40

Terminal block	48,6	23,5	85/ for cl. 30
4-way valve	53,9	60,2	110 (Class B)
Internal wire to compressor	53,3	33,0	T105
PCB	50,6	24,7	145
Interconnection cord	50,2	24,4	75
Enclosure	48,8	23,1	85/ for cl. 30
Transformer	54,6	31,1	110 (Class B)
Varistor	54,5	30,7	T85
Test corner	53,6	19,9	90

**Supplementary information:**

**Cooling mode:** Indoor unit: DB 35 °C, WB: 23 °C, outdoor unit: DB 50 °C, WB: 32 °C;

**Heating mode:** Indoor unit: DB 30 °C, WB: 19 °C, outdoor unit: DB 30 °C, WB: 19 °C

The alternative components with the appliance were also conducted; the most unfavourable test results were recorded.

<b>11.8-18</b>	<b>TABLE: Heating test, resistance method</b>					N/A	
	Test voltage (V) .....	---			---		
	Ambient, t1 (°C) .....	---			---		
	Ambient, t2 (°C) .....	---			---		
Temperature rise of winding	R1 (Ω)		R2 (Ω)		T (°C)	Max. T (°C)	Insulation class
	Main	Sub	Main	Sub			

Supplementary information:

<b>11.8-19</b>	<b>TABLE: Heating test</b> Model H equipped with indoor fan motor (Sanjiang) and outdoor fan motor (Broad-Ocean).					P
	Test voltage (V) .....	1,06 x 240 V = 254,4 V			---	
	Ambient (°C) .....	See supplementary information			---	
Thermocouple locations	Max. temperature measured, T (°C)				Max. temperature limit, T (°C)	
	Cooling mode		Heating mode			
<b>Indoor unit</b>						
Indoor fan motor	33,1	31,4	105 (Class E)			
Relay	44,2	42,5	T70			
Terminal block	33,7	31,3	85/ for cl. 30			
PCB	32,0	29,0	140			
Supply cord	32,2	29,7	75			

<b>IEC 60335-2-40</b>			
Air outlet	21,4	49,7	90
Transformer	48,7	47,5	110 (Class B)
X2 capacitor	42,1	40,1	T85
Varistor	38,6	37,4	T85
Step motor	31,9	29,4	105 (Class E)
Test corner	32,2	28,9	90
Enclosure	32,2	29,0	85/ for cl. 30
<b>Outdoor unit</b>			
Motor compressor (top)	77,5	71,3	150
Refrigerant pipe	85,0	81,9	150
X2 capacitor	53,9	30,3	T85
Relay	50,9	25,8	T70
Outdoor fan motor	59,0	23,8	105 (Class E)
Electrolytic capacitor	53,4	31,0	T105
IPM	62,8	34,5	Ref.
Bridge rectifier	65,3	37,5	Ref.
Terminal block	48,7	23,8	85/ for cl. 30
4-way valve	55,2	62,9	110 (Class B)
Internal wire to compressor	53,5	33,3	T105
PCB	50,9	25,1	145
Interconnection cord	50,6	24,6	75
Enclosure	48,3	23,5	85/ for cl. 30
Transformer	55,1	31,0	110 (Class B)
Varistor	54,4	29,4	T85
Test corner	53,5	19,5	90
<b>Supplementary information:</b>			
<b>Cooling mode:</b> Indoor unit: DB 35 °C, WB: 23 °C, outdoor unit: DB 50 °C, WB: 32 °C;			
<b>Heating mode:</b> Indoor unit: DB 30 °C, WB: 19 °C, outdoor unit: DB 30 °C, WB: 19 °C			
The alternative components with the appliance were also conducted; the most unfavourable test results were recorded.			
<b>11.8-19</b>	<b>TABLE: Heating test, resistance method</b>		N/A
	Test voltage (V) .....	---	—
	Ambient, t1 (°C) .....	---	—

## IEC 60335-2-40

Ambient, t2 (°C) .....		---		---		---	
Temperature rise of winding	R1 (Ω)		R2 (Ω)		T (°C)	Max. T (°C)	Insulation class
	Main	Sub	Main	Sub			
Supplementary information:							

<b>11.8-20</b>	<b>TABLE: Heating test</b> Model H equipped with indoor fan motor (Tongda) and outdoor fan motor (Tongda).			P
	Test voltage (V) .....	1,06 x 240 V = 254,4 V		---
	Ambient (°C) .....	See supplementary information		---
Thermocouple locations	Max. temperature measured, T (°C)		Max. temperature limit, T (°C)	
	Cooling mode	Heating mode		
<b>Indoor unit</b>				
Indoor fan motor	32,7	31,4	105 (Class E)	
Relay	43,8	42,7	T70	
Terminal block	33,4	31,5	85/ for cl. 30	
PCB	31,7	29,1	140	
Supply cord	31,9	29,8	75	
Air outlet	21,1	49,5	90	
Transformer	48,4	47,6	110 (Class B)	
X2 capacitor	41,8	40,3	T85	
Varistor	38,3	37,6	T85	
Step motor	31,4	29,9	105 (Class E)	
Test corner	31,8	28,9	90	
Enclosure	31,8	28,9	85/ for cl. 30	
<b>Outdoor unit</b>				
Motor compressor (top)	78,0	72,3	150	
Refrigerant pipe	85,0	83,0	150	
X2 capacitor	54,4	31,0	T85	
Relay	51,1	26,5	T70	
Outdoor fan motor	59,8	24,0	105 (Class E)	
Electrolytic capacitor	53,9	31,1	T105	
IPM	61,4	35,8	Ref.	

## IEC 60335-2-40

Bridge rectifier	64,7	38,2	Ref.
Terminal block	47,7	22,4	85/ for cl. 30
4-way valve	56,4	66,2	110 (Class B)
Internal wire to compressor	53,7	33,4	T105
PCB	50,8	25,2	145
Interconnection cord	51,2	26,3	75
Enclosure	49,6	24,7	85/ for cl. 30
Transformer	54,9	31,4	110 (Class B)
Varistor	54,8	30,5	T85
Test corner	53,6	19,3	90

**Supplementary information:**

**Cooling mode:** Indoor unit: DB 35 °C, WB: 23 °C, outdoor unit: DB 50 °C, WB: 32 °C;

**Heating mode:** Indoor unit: DB 30 °C, WB: 19 °C, outdoor unit: DB 30 °C, WB: 19 °C

The alternative components with the appliance were also conducted; the most unfavourable test results were recorded.

<b>11.8-20</b>	<b>TABLE: Heating test, resistance method</b>					N/A	
	Test voltage (V) .....	---			---		
	Ambient, t1 (°C) .....	---			---		
	Ambient, t2 (°C) .....	---			---		
Temperature rise of winding	R1 (Ω)		R2 (Ω)		T (°C)	Max. T (°C)	Insulation class
	Main	Sub	Main	Sub			

**Supplementary information:**

<b>11.8-21</b>	<b>TABLE: Heating test Model H equipped with outdoor fan motor (Nidec).</b>					P
	Test voltage (V) .....	1,06 x 240 V = 254,4 V			---	
	Ambient (°C) .....	See supplementary information			---	
Thermocouple locations	Max. temperature measured, T (°C)			Max. temperature limit, T (°C)		
	Cooling mode		Heating mode			
<b>Indoor unit</b>						
Indoor fan motor	34,4	34,9	105 (Class E)			
Relay	32,8	30,6	T70			
Terminal block	32,8	30,5	85/ for cl. 30			
PCB	31,6	29,0	140			
Supply cord	32,2	29,5	75			

<b>IEC 60335-2-40</b>			
Air outlet	18,6	47,8	90
Transformer	47,3	46,4	110 (Class B)
X2 capacitor	40,5	39,0	T85
Varistor	36,8	34,7	T85
Step motor	31,7	28,9	105 (Class E)
Test corner	32,0	28,6	90
Enclosure	32,0	28,7	85/ for cl. 30
<b>Outdoor unit</b>			
Motor compressor (top)	86,8	75,8	150
Refrigerant pipe	90,3	79,5	150
X2 capacitor	54,3	29,6	T85
Relay	50,4	25,5	T70
Outdoor fan motor	62,3	24,9	105 (Class E)
Electrolytic capacitor	52,1	29,3	T105
IPM	67,1	34,9	Ref.
Bridge rectifier	64,7	33,7	Ref.
Terminal block	49,3	25,6	85/ for cl. 30
4-way valve	56,0	64,4	110 (Class B)
Internal wire to compressor	56,3	35,7	T105
PCB	50,3	24,7	145
Interconnection cord	50,6	25,0	75
Enclosure	48,7	24,6	85/ for cl. 30
Transformer	54,7	31,0	110 (Class B)
Varistor	55,7	29,6	T85
Test corner	55,0	20,0	90
<b>Supplementary information:</b>			
<b>Cooling mode:</b> Indoor unit: DB 35 °C, WB: 23 °C, outdoor unit: DB 50 °C, WB: 32 °C;			
<b>Heating mode:</b> Indoor unit: DB 30 °C, WB: 19 °C, outdoor unit: DB 30 °C, WB: 19 °C			
The alternative components with the appliance were also conducted; the most unfavourable test results were recorded.			
<b>11.8-21</b>	<b>TABLE: Heating test, resistance method</b>		N/A
	Test voltage (V) .....	---	—
	Ambient, t1 (°C) .....	---	—

## IEC 60335-2-40

Ambient, t <sub>2</sub> (°C) .....		---				—	
Temperature rise of winding	R1 (Ω)		R2 (Ω)		T (°C)	Max. T (°C)	Insulation class
	Main	Sub	Main	Sub			
Supplementary information:							

<b>11.8-22</b>	<b>TABLE: Heating test</b> Model C equipped with indoor fan motor ZKFP-13-8-4 (Shibaura) and outdoor fan motor ZKFN-20-8-1 (JEAMO).			P
	Test voltage (V) .....	1,06 x 240 V = 254,4 V		—
	Ambient (°C) .....	See supplementary information		—
Thermocouple locations		Max. temperature measured, T (°C)		Max. temperature limit, T (°C)
		Cooling mode	Heating mode	
<b>Indoor unit</b>				
Indoor fan motor		37,6	38,8	105 (Class E)
Relay		41,8	42,8	T70
Terminal block		32,8	31,9	85/ for cl. 30
PCB		39,4	40,5	140
Interconnector cord		32,8	32,3	75
Air outlet		20,0	54,2	90
Transformer		47,9	47,8	110 (Class B)
X2 capacitor		45,2	44,6	T85
Varistor		37,2	38,8	T85
Step motor		40,4	42,4	105 (Class E)
Test corner		32,3	30,1	90
Enclosure		32,7	31,1	85/ for cl. 30
<b>Outdoor unit</b>				
Motor compressor (top)		83,0	67,3	150
Refrigerant pipe		86,7	72,8	150
X2 capacitor		53,7	26,1	T85
Relay		53,8	26,4	T70
Outdoor fan motor		63,8	27,9	105 (Class E)
Electrolytic capacitor		54,0	27,4	T105
IPM		59,4	30,0	Ref.

## IEC 60335-2-40

Bridge rectifier	61,1	31,8	Ref.
Terminal block	52,2	24,6	85/ for cl. 30
4-way valve	55,5	53,5	110 (Class B)
Internal wire to compressor	63,6	43,1	T105
PCB	52,4	24,8	145
Power cord	52,4	24,8	75
Enclosure	52,8	24,6	85/ for cl. 30
Transformer	52,6	26,2	110 (Class B)
Varistor	52,8	25,4	T85
Test corner	51,7	25,0	90

**Supplementary information:**

**Cooling mode:** Indoor unit: DB 35 °C, WB: 23 °C, outdoor unit: DB 50 °C, WB: 32 °C;

**Heating mode:** Indoor unit: DB 30 °C, WB: 19 °C, outdoor unit: DB 30 °C, WB: 19 °C

The alternative components with the appliance were also conducted; the most unfavourable test results were recorded.

<b>11.8-22</b>	<b>TABLE: Heating test, resistance method</b>					N/A	
	Test voltage (V) .....	---			---		
	Ambient, t1 (°C) .....	---			---		
	Ambient, t2 (°C) .....	---			---		
Temperature rise of winding	R1 (Ω)		R2 (Ω)		T (°C)	Max. T (°C)	Insulation class
	Main	Sub	Main	Sub			

Supplementary information:

<b>11.8-23</b>	<b>TABLE: Heating test Model C equipped with indoor fan motor ZKFP-13-8-4 (Wolong) and outdoor fan motor ZKFN-20-8-1 (JEAMO)</b>					P
	Test voltage (V) .....	1,06 x 240 V = 254,4 V			---	
	Ambient (°C) .....	See supplementary information			---	
Thermocouple locations	Max. temperature measured, T (°C)				Max. temperature limit, T (°C)	
	Cooling mode		Heating mode			
<b>Indoor unit</b>						
Indoor fan motor	35,0	35,6	105 (Class E)			
Relay	51,3	52,9	T70			
Terminal block	32,7	31,4	85/ for cl. 30			
PCB	34,8	34,3	140			

<b>IEC 60335-2-40</b>			
Interconnector cord	32,3	31,1	75
Air outlet	19,4	52,7	90
Transformer	44,7	45,9	110 (Class B)
X2 capacitor	43,4	43,1	T85
Varistor	36,1	36,6	T85
Step motor	31,8	30,5	105 (Class E)
Test corner	32,6	30,1	90
Enclosure	32,4	30,8	85/ for cl. 30
<b>Outdoor unit</b>			
Motor compressor (top)	87,3	66,6	150
Refrigerant pipe	91,3	71,4	150
X2 capacitor	53,8	26,5	T85
Relay	54,1	26,7	T70
Outdoor fan motor	63,3	28,2	105 (Class E)
Electrolytic capacitor	54,3	27,8	T105
IPM	59,9	30,3	Ref.
Bridge rectifier	62,2	32,4	Ref.
Terminal block	52,0	25,0	85/ for cl. 30
4-way valve	56,5	53,8	110 (Class B)
Internal wire to compressor	65,7	43,3	T105
PCB	52,2	24,8	145
Power cord	52,4	25,2	75
Enclosure	52,9	24,9	85/ for cl. 30
Transformer	52,6	26,8	110 (Class B)
Varistor	53,0	25,8	T85
Test corner	51,7	24,8	90
<b>Supplementary information:</b>			
<b>Cooling mode:</b> Indoor unit: DB 35 °C, WB: 23 °C, outdoor unit: DB 50 °C, WB: 32 °C;			
<b>Heating mode:</b> Indoor unit: DB 30 °C, WB: 19 °C, outdoor unit: DB 30 °C, WB: 19 °C			
The alternative components with the appliance were also conducted; the most unfavourable test results were recorded.			
<b>11.8-22</b>	<b>TABLE: Heating test, resistance method</b>		N/A
	Test voltage (V) .....	---	—

## IEC 60335-2-40

Ambient, t1 (°C) .....		---		---			
Ambient, t2 (°C) .....		---		---			
Temperature rise of winding	R1 (Ω)		R2 (Ω)		T (°C)	Max. T (°C)	Insulation class
	Main	Sub	Main	Sub			
Supplementary information: ---							

<b>13.2</b>	<b>TABLE: Leakage current</b>					P
	Heating appliances: 1,15 x rated input (W).....:		----		---	
	Motor-operated and combined appliances: 1,06 x rated voltage (V).....:		1,06 x 240 V = 254,4 V		---	
Leakage current between			I (mA)	Max. allowed I (mA)		
L/N and earthed metal parts			0,49	3,5		
L/N and accessible plastic parts			0,045 peak	0,35 (peak)		
Supplementary information: ---						

<b>13.3</b>	<b>TABLE: Dielectric strength</b>					P
Test voltage applied between:			Test potential applied (V)	Breakdown / flashover (Yes/No)		
L/N and plastic enclosure			3000	No		
L/N and earthed metal enclosure			1000	No		
Supplementary information: ---						

<b>14</b>	<b>TABLE: Transient overvoltages</b>					N/A
Clearance between:		Cl (mm)	Required Cl (mm)	Rated impulse voltage (V)	Impulse test voltage (V)	Flashover (Yes/No)
Supplementary information: ---						

<b>16.2</b>	<b>TABLE: Leakage current</b>					P
	Single phase appliances: 1,06 x rated voltage (V).....:		1,06 x 240 V = 254,4 V		---	
	Three phase appliances 1,06 x rated voltage divided by $\sqrt{3}$ (V).....:		----		---	
Leakage current between			I (mA)	Max. allowed I (mA)		
L/N and earthed metal parts			0,54	3,5		
L/N and accessible plastic parts			0,18	0,25		
Supplementary information: ---						

## IEC 60335-2-40

16.3	TABLE: Dielectric strength		P
Test voltage applied between:	Test potential applied (V)	Breakdown / flashover (Yes/No)	
L/N and plastic enclosure	3000	No	
L/N and earthed metal enclosure	1250	No	
Supplementary information: ---			

17	TABLE: Overload protection		P
Thermocouple locations	Max. temperature rise measured, $\Delta T$ (K)	Max. temperature rise limit, $\Delta T$ (K)	
Transformer winding EE2515K222(EE25(5+5)2/P5-0.547L1) (Jiayang)	68,3°C	225°C	
Transformer winding EE2515K222(EE25(5+5)2/P5-0.547L1) (Weimei)	83,2°C	225°C	
Transformer winding EE2515K222(EE25(5+5)2/P5-0.547L1) (Jewel)	89,5°C	225°C	
Transformer winding EE2515K222(EE25(5+5)2/P5-0.547L1) (Zhanliang)	89,0°C	225°C	
Transformer winding E22084(EE22(5+5)2/P4-1.52L2) (Phoenix)	71,6°C	225°C	
Transformer winding E22084(EE22(5+5)2/P4-1.52L2) (Jiayang)	67,5°C	225°C	
Transformer winding E22084(EE22(5+5)2/P4-1.52L2) (Jewel)	68,3°C	225°C	
Transformer winding EE22(5+4)3P4-1.1L5 (Zhanliang)	84,0°C	225°C	
Transformer winding EE22(5+4)3P4-1.1L5 (Jewel)	84,6°C	225°C	
Transformer winding EE22(5+4)3P4-1.1L5 (Jiayang)	83,0°C	225°C	
Transformer winding EE22(5+4)3P4-1.1L5 (Weimei)	83,2°C	225°C	
Transformer winding EE22(5+4)3P4-1.1L5 (Ruichuang)	84,5°C	225°C	
Supplementary information: ---			

17	TABLE: Overload protection, resistance method			N/A
Test voltage (V) .....				—
Ambient, t1 (°C) .....				—
Ambient, t2 (°C) .....				—
Temperature of winding	R1 ( $\Omega$ )	R2 ( $\Omega$ )	$\Delta T$ (K)	T (°C)
Supplementary information:				

19	Abnormal operation conditions		P
Operational characteristics	YES/NO	Operational conditions	
Are there electronic circuits to control the appliance operation?	YES	19.7: 23 °C $\pm$ 5 °C, rated frequency and voltage. For others: under the most sever operating conditions specified by the manufacturer	

## IEC 60335-2-40

Are there "off" or "stand-by" position?		YES	19.7: 23 °C ± 5 °C, rated frequency and voltage. For others: under the most sever operating conditions specified by the manufacturer				
The unintended operation of the appliance results in dangerous malfunction?		NO	---				
Sub-clause	Operating conditions description	Test results description	PEC description	EMP 19.11.4	Software type required	19.11.3 PEC	Final result
19.2	(1)	No hazard observed, measured temperature below limit	N.A	N.A	N.A	N.A	P
19.3	N.A	N.A	N.A	N.A	N.A	N.A	N.A
19.4	N.A	N.A	N.A	N.A	N.A	N.A	N.A
19.5	(4)	No hazard observed, measured temperature below limit	N.A	N.A	N.A	N.A	P
19.6	N.A	N.A	N.A	N.A	N.A	N.A	N.A
19.7	(5)	No hazard observed, measured temperature below limit	N.A	N.A	N.A	N.A	P
19.8	N.A	N.A	N.A	N.A	N.A	N.A	N.A
19.9	N.A	N.A	N.A	N.A	N.A	N.A	N.A
19.10	(2)	No hazard observed, measured temperature below limit	N.A	N.A	N.A	N.A	P
19.11.2	(3)	No hazard observed, measured temperature below limit	N.A	N.A	N.A	N.A	P
19.11.4.8	N.A	N.A	N.A	N.A	N.A	N.A	N.A
19.10X	N.A	N.A	N.A	N.A	N.A	N.A	N.A
Supplementary information: (1) Locked the fan motor rotor and operated for 15 days; (2) OC and SC fan motor running capacitor and compressor running capacitor; (3) Simulated every one fault at a time and until steady condition or ended if a interruption occur; (4) Restricted the air inlet of outdoor exchanger and indoor exchanger; (5) Dry-bulb temperature increased 10K above the maximum temperature in cooling mode Dry-bulb temperature reduced 5K below the minimum temperature in heating mode							

## IEC 60335-2-40

19.2	Abnormal operation conditions – locked rotor test other than motor-compressors				P
	Ambient, t1 (°C):	25,0 °C			—
	Ambient, t2 (°C):	25,0 °C			—
	Test voltage (V):	240V / DC12V			—
Temperature limit T of winding:	R <sub>1</sub> (Ω)	R <sub>2</sub> (Ω)	Measured T (°C)	Limit T (°C)	Insulation class
Fan motor winding ZKFP-20-8-6 (Tongda)	—	—	30,0	215	E
Fan motor enclosure ZKFP-20-8-6 (Tongda)	—	—	30,0	150	E
Fan motor winding ZKFP-20-8-6 (Sanjiang)	—	—	83,2	215	E
Fan motor enclosure ZKFP-20-8-6 (Sanjiang)	—	—	60,2	150	E
Fan motor winding ZKFP-20-8-6 (Welling)	—	—	26,2	215	E
Fan motor enclosure ZKFP-20-8-6 (Welling)	—	—	24,5	150	E
Fan motor winding ZKFP-13-8-4 (Welling)	—	—	63,0	215	E
Fan motor enclosure ZKFP-13-8-4 (Welling)	—	—	58,4	150	E
Fan motor winding ZKFP-13-8-4 (Sanjiang)	—	—	101,7	215	E
Fan motor enclosure ZKFP-13-8-4 (Sanjiang)	—	—	75,6	150	E
Fan motor winding ZKFP-13-8-4 (Tongda)	—	—	52,0	215	E
Fan motor enclosure ZKFP-13-8-4 (Tongda)	—	—	51,0	150	E
Fan motor winding ZKFP-30-8-3 (Broad-Ocean)	—	—	26,5	215	E
Fan motor enclosure ZKFP-30-8-3 (Broad-Ocean)	—	—	25,5	150	E
Fan motor winding ZKFP-30-8-3 (Welling)	—	—	26,1	215	E
Fan motor enclosure ZKFP-30-8-3 (Welling)	—	—	24,3	150	E
Fan motor winding ZKFP-30-8-3 (Shibaura)	—	—	26,8	215	E
Fan motor enclosure ZKFP-30-8-3 (Shibaura)	—	—	25,7	150	E
Fan motor winding ZKFP-58-8-1 (Broad-Ocean)	—	—	27,7	215	E
Fan motor enclosure ZKFP-58-8-1 (Broad-Ocean)	—	—	25,8	150	E
Fan motor winding ZKFP-58-8-1 (Shibaura)	—	—	26,8	215	E
Fan motor enclosure ZKFP-58-8-1 (Shibaura)	—	—	25,5	150	E
Fan motor winding ZKFN-20-8-1 (Broad-Ocean)	—	—	25,7	215	E
Fan motor enclosure ZKFN-20-8-1 (Broad-Ocean)	—	—	25,6	150	E
Fan motor winding ZKFN-20-8-1 (Welling)	—	—	26,1	215	E
Fan motor enclosure ZKFN-20-8-1 (Welling)	—	—	25,6	150	E

## IEC 60335-2-40

Fan motor winding ZKFN-20-8-1 (Tongda)	—	—	25,8	215	E
Fan motor enclosure ZKFN-20-8-1 (Tongda)	—	—	25,5	150	E
Fan motor winding ZKFN-34-10-1 (Welling)	—	—	74,9	215	E
Fan motor enclosure ZKFN-34-10-1 (Welling)	—	—	74,9	150	E
Fan motor winding ZKFN-34-10-1 (Tongda)	—	—	33,0	215	E
Fan motor enclosure ZKFN-34-10-1 (Tongda)	—	—	31,0	150	E
Fan motor winding ZKFN-34-10-1 (Shibaura)	—	—	105,8	215	E
Fan motor enclosure ZKFN-34-10-1 (Shibaura)	—	—	85,4	150	E
Fan motor winding ZKFN-80-8-3 (Broad-Ocean)	—	—	32,4	215	E
Fan motor enclosure ZKFN-80-8-3 (Broad-Ocean)	—	—	33,5	150	E
Fan motor winding ZKFN-80-8-3 (Welling)	—	—	47,9	215	E
Fan motor enclosure ZKFN-80-8-3 (Welling)	—	—	41,7	150	E
Fan motor winding ZKFN-80-8-3 (Tongda)	—	—	34,0	215	E
Fan motor enclosure ZKFN-80-8-3 (Tongda)	—	—	31,0	150	E
Fan motor winding ZKFP-58-8-1 (Welling)	—	—	30,6	215	E
Fan motor enclosure ZKFP-58-8-1 (Welling)	—	—	31,3	150	E
Fan motor winding ZKFN-34-10-1 (Welling)	—	—	74,9	215	E
Fan motor enclosure ZKFN-34-10-1 (Welling)	—	—	74,9	150	E
Fan motor winding ZKFN-34-10-1 (Tongda)	—	—	33,0	215	E
Fan motor enclosure ZKFN-34-10-1 (Tongda)	—	—	31,0	150	E
Fan motor winding ZKFN-34-10-1 (Shibaura)	—	—	105,8	215	E
Fan motor enclosure ZKFN-34-10-1 (Shibaura)	—	—	85,4	150	E
Fan motor winding ZKFN-34-10-1 (Broad-Ocean)	—	—	60,5	215	E
Fan motor enclosure ZKFN-34-10-1 (Broad-Ocean)	—	—	59,4	150	E
Fan motor winding (ZKFP-13-8-4) NIDEC	—	—	86,1	215	E
Fan motor enclosure (ZKFP-13-8-4) NIDEC	—	—	77,8	150	E
Fan motor winding (ZKFP-13-8-4) Wolong	—	—	50,8	215	E
Fan motor enclosure (ZKFP-13-8-4) Wolong	—	—	44,4	150	E
Fan motor winding ZKFN-20-8-1 (JEAMO)	—	—	41,9	215	E
Fan motor enclosure ZKFN-20-8-1 (JEAMO)	—	—	37,7	150	E
Step motor (Max.)	—	—	54,7	150	E

## IEC 60335-2-40

19.2	TABLE: electric strength measurements after 72 hours		P
Test voltage applied between:		Test voltage (V)	Breakdown Yes / No
B/W winding and fan motor enclosure		1250	No

19.2	TABLE: leakage current measurements after 72 hours		P
A voltage equal to twice the rated voltage (V):		480 V	—
Leakage current I between:		I (mA)	Required I (mA)
B/W winding and fan motor enclosure		0,52	2

19.3	Abnormal operation conditions – Locked rotor test motor-compressor				P
	Motor-compressor .....	KSK103D33UEZ3			
	Start device .....	--			
	Protector .....	--			
	Start capacitor .....	--			
	Run capacitor .....	--			
	Cooling; (static); (fan-m <sup>3</sup> /h); (oil); .....	--			
	Thermal motor-protection system .....	--			
		Self-resetting			Manually reset
	Rated voltage	Vn max (V)			Vn min (V)
		After 72 h	After 288 h	After 360 h	After 363 h
	High-voltage test (see 16.3)	--	--	--	--
	Leakage current (mA) (see 16.2)	--	--	--	--
	Electric strength (see 13.3)	--	--	--	--
	Room temperature (°C) (20 ± 5°C)	--	--	--	--
	Number of cycles (≥ 2000 or 50)	--	--	--	--
	Housing temperature (°C) (≤ 150°C)	--	--	--	--
supplementary information: The compressor locked with the protective electronic circuit disabled, then the resistance and fuse on the main controller broken					

19.3	Abnormal operation conditions – Locked rotor test motor-compressor		P
	Motor-compressor .....	KSN98D22UFZ	
	Start device .....	--	
	Protector .....	--	
	Start capacitor .....	--	
	Run capacitor .....	--	

## IEC 60335-2-40

	Cooling; (static); (fan-m <sup>3</sup> /h); (oil); .....	--			
	Thermal motor-protection system .....	--			
		Self-resetting			Manually reset
Rated voltage		Vn max (V)			Vn min (V)
		After 72 h	After 288 h	After 360 h	After 363 h
		After 72 h	After 288 h	After 360 h	After 50 cycles
High-voltage test (see 16.3)		--	--	--	--
Leakage current (mA) (see 16.2)		--	--	--	--
Electric strength (see 13.3)		--	--	--	--
Room temperature (°C) (20 ± 5°C)		--	--	--	--
Number of cycles (≥ 2000 or 50)		--	--	--	--
Housing temperature (°C) (≤ 150°C)		--	--	--	--
supplementary information: The compressor locked with the protective electronic circuit disabled, then the resistance and fuse on the main controller broken					

<b>19.3</b>	<b>Abnormal operation conditions – Locked rotor test motor-compressor</b>				P
	Motor-compressor.....	KSN140D21UFZ			
	Start device .....	--			
	Protector.....	--			
	Start capacitor .....	--			
	Run capacitor .....	--			
	Cooling; (static); (fan-m <sup>3</sup> /h); (oil); .....	--			
	Thermal motor-protection system .....	--			
		Self-resetting			Manually reset
Rated voltage		Vn max (V)			Vn min (V)
		After 72 h	After 288 h	After 360 h	After 363 h
		After 72 h	After 288 h	After 360 h	After 50 cycles
High-voltage test (see 16.3)		--	--	--	--
Leakage current (mA) (see 16.2)		--	--	--	--
Electric strength (see 13.3)		--	--	--	--
Room temperature (°C) (20 ± 5°C)		--	--	--	--
Number of cycles (≥ 2000 or 50)		--	--	--	--
Housing temperature (°C) (≤ 150°C)		--	--	--	--
supplementary information: The compressor locked with the protective electronic circuit disabled, then the resistance and fuse on the main controller broken					

## IEC 60335-2-40

19.3	Abnormal operation conditions – Locked rotor test motor-compressor				P
	Motor-compressor .....	KTM240D57UMT			
	Start device .....	--			
	Protector .....	--			
	Start capacitor .....	--			
	Run capacitor .....	--			
	Cooling; (static); (fan-m <sup>3</sup> /h); (oil); .....	--			
	Thermal motor-protection system .....	--			
		Self-resetting			Manually reset
Rated voltage		Vn max (V)			Vn min (V)
		After 72 h	After 288 h	After 360 h	After 363 h
High-voltage test (see 16.3)		--	--	--	--
Leakage current (mA) (see 16.2)		--	--	--	--
Electric strength (see 13.3)		--	--	--	--
Room temperature (°C) (20 ± 5°C)		--	--	--	--
Number of cycles (≥ 2000 or 50)		--	--	--	--
Housing temperature (°C) (≤ 150°C)		--	--	--	--
supplementary information: The compressor locked with the protective electronic circuit disabled, then the resistance and fuse on the main controller broken					

## IEC 60335-2-40

<b>19.3</b>	<b>Abnormal operation conditions – Locked rotor test motor-compressor</b>				P
	Motor-compressor .....	KSN98D64UFZ3			
	Start device .....	--			
	Protector .....	--			
	Start capacitor .....	--			
	Run capacitor .....	--			
	Cooling; (static); (fan-m <sup>3</sup> /h); (oil); .....	--			
	Thermal motor-protection system .....	--			
		Self-resetting			Manually reset
Rated voltage		Vn max (V)			Vn min (V)
		After 72 h	After 288 h	After 360 h	After 363 h
		After 50 cycles			
High-voltage test (see 16.3)	--	--	--	--	--
Leakage current (mA) (see 16.2)	--	--	--	--	--
Electric strength (see 13.3)	--	--	--	--	--
Room temperature (°C) (20 ± 5°C)	--	--	--	--	--
Number of cycles (≥ 2000 or 50)	--	--	--	--	--
Housing temperature (°C) (≤ 150°C)	--	--	--	--	--
supplementary information: The compressor locked with the protective electronic circuit disabled, then the resistance and fuse on the main controller broken					

<b>19.5-19.9</b>	<b>Abnormal operation conditions</b>		P
Subclause	Effect	Verdict	
19.5	No hazard was found	P	
19.6	/	N/A	
19.7	No hazard was found	P	
19.8	/	N/A	
19.9	/	N/A	
Supplementary information:			

<b>19.10</b>	<b>Abnormal operation conditions</b>		N/A
Failure description	Effect	Verdict	
Supplementary information:			

## IEC 60335-2-40

19.11.2		Abnormal Operation			P
Fault condition	Short circuit	Open circuit	Effect	Verdict	
Indoor controller for A, B, C, D, F, G, H					
ZR1	X		No hazard, fuse broken	P	
BR1 pin1-pin2	X		No hazard, not normal operation	P	
BR1 pin1-pin4	X		No hazard, not normal operation	P	
IC491 pin 2-pin3	X		No hazard, not normal operation	P	
IC491 pin 4-pin3	X		No hazard, not normal operation	P	
IC491 pin 5-pin3	X		No hazard, not normal operation	P	
IC491 pin 7-pin3	X		No hazard, not normal operation	P	
D492	X		No hazard, not normal operation	P	
E491	X		No hazard, not normal operation	P	
IC492 pin1-pin2	X		No hazard, not normal operation	P	
IC492 pin3-pin4	X		No hazard, not normal operation	P	
IC492 pin3	X		No hazard, not normal operation	P	
T491 pin1-pin3	X		No hazard, not normal operation	P	
T491 pin4-pin5	X		No hazard, not normal operation	P	
T491 pin6-pin9	X		No hazard, not normal operation	P	
D494	X		No hazard, not normal operation	P	
E494	X		No hazard, not normal operation	P	
D493	X		No hazard, not normal operation	P	
E499	X		No hazard, not normal operation	P	
E494	X		No hazard, not normal operation		
E499	X		No hazard, not normal operation		
Indoor controller for E					
ZR1	X		No hazard, fuse broken	P	
BR1 pin 1-3	X		No hazard, not normal operation	P	
BR1 pin 1-4	X		No hazard, not normal operation	P	
E1	X		No hazard, not normal operation	P	
T1 pin 1-pin 3	X		No hazard, not normal operation	P	
T1 pin 4-pin 5	X		No hazard, not normal operation	P	
T1 pin 6-pin 7	X		No hazard, not normal operation	P	

## IEC 60335-2-40

T1 pin 9- pin 10	X		No hazard, not normal operation	P
D2	X		No hazard, not normal operation	P
E3	X		No hazard, not normal operation	P
IC1 pin 4-pin 5	X		No hazard, not normal operation	P
IC1 pin 2-pin 5	X		No hazard, not normal operation	P
IC1 pin 1-pin 5	X		No hazard, not normal operation	P
IC9 pin 1- pin 2	X		No hazard, not normal operation	P
IC9 pin 3-pin 4	X		No hazard, not normal operation	P
IC9 pin3	X		No hazard, not normal operation	P
D3	X		No hazard, not normal operation	P
E2	X		No hazard, not normal operation	P
D12	X		No hazard, not normal operation	P
E16	X		No hazard, not normal operation	
Outdoor controller for A, B, C, D, F, G, H				
ZR1	X		No hazard, fuse broken	P
ZR2	X		No hazard, fuse broken	P
BR1 pin 1-2	X		No hazard, not normal operation	P
BR1 pin 1-4	X		No hazard, not normal operation	P
Q601 pin b -pin e	X		No hazard, not normal operation	P
Q601 pin b -pin g	X		No hazard, not normal operation	P
Q601 pin e -pin g	X		No hazard, not normal operation	P
E1	X		No hazard, fuse broken	P
T401 pin 1-pin 3	X		No hazard, not normal operation	P
T401 pin 4-pin 5	X		No hazard, not normal operation	P
T401 pin 6-pin 7	X		No hazard, not normal operation	P
T401 pin 9- pin 10	X		No hazard, not normal operation	P
D402	X		No hazard, not normal operation	P
E401	X		No hazard, not normal operation	P
IC 401 pin5-pin2	X		No hazard, not normal operation	P
IC 401 pin7-pin2	X		No hazard, not normal operation	P
IC 401 pin4-pin2	X		No hazard, not normal operation	P
IC402 pin 1- pin 2	X		No hazard, not normal operation	P

## IEC 60335-2-40

IC402 pin 3-pin 4	X		No hazard, not normal operation	P
IC402 pin3	X		No hazard, not normal operation	P
D404	X		No hazard, not normal operation	P
E402	X		No hazard, not normal operation	P
D403	X		No hazard, not normal operation	P
E403	X		No hazard, not normal operation	P
IPM301 pin2-pin16	X		No hazard, not normal operation	P
IPM301 pin3-pin16	X		No hazard, not normal operation	P
IPM301 pin4-pin16	X		No hazard, not normal operation	P
IPM301 pin5-pin16	X		No hazard, not normal operation	P
IPM301 pin6-pin16	X		No hazard, not normal operation	P
IPM301 pin7-pin16	X		No hazard, not normal operation	P
IPM301 pin8-pin16	X		No hazard, not normal operation	P
IPM301 pin10-pin16	X		No hazard, not normal operation	P
IPM301 pin11-pin16	X		No hazard, not normal operation	P
IPM301 pin12-pin16	X		No hazard, not normal operation	P
IPM301 pin13-pin16	X		No hazard, not normal operation	P
IPM301 pin14-pin16	X		No hazard, not normal operation	P
IPM301 pin15-pin16	X		No hazard, not normal operation	P
IPM301 pin17-pin16	X		No hazard, not normal operation	P
IPM301 pin18-pin16	X		No hazard, not normal operation	P
IPM301 pin21-pin16	X		No hazard, not normal operation	P
IPM301 pin22-pin16	X		No hazard, not normal operation	P
IPM301 pin23-pin16	X		No hazard, not normal operation	P
IPM301 pin24-pin16	X		No hazard, not normal operation	P
IPM301 pin21-pin22	X		No hazard, not normal operation	P
IPM301 pin21-pin23	X		No hazard, not normal operation	P
IPM301 pin22-pin23	X		No hazard, not normal operation	P
IPM501 pin4-pin8	X		No hazard, not normal operation	P
IPM501 pin5-pin8	X		No hazard, not normal operation	P
IPM501 pin6-pin8	X		No hazard, not normal operation	P
IPM501 pin7-pin8	X		No hazard, not normal operation	P

## IEC 60335-2-40

IPM501 pin9-pin8	X		No hazard, not normal operation	P
IPM501 pin10-pin8	X		No hazard, not normal operation	P
IPM501 pin11-pin8	X		No hazard, not normal operation	P
IPM501 pin12-pin8	X		No hazard, not normal operation	P
IPM501 pin13-pin8	X		No hazard, not normal operation	P
IPM501 pin14-pin8	X		No hazard, not normal operation	P
IPM501 pin15-pin8	X		No hazard, not normal operation	P
IPM501 pin20-pin8	X		No hazard, not normal operation	P
IPM501 pin21-pin8	X		No hazard, not normal operation	P
IPM501 pin22-pin8	X		No hazard, not normal operation	P
IPM501 pin23-pin8	X		No hazard, not normal operation	P
IPM501 pin25-pin8	X		No hazard, not normal operation	P
IPM501 pin26-pin8	X		No hazard, not normal operation	P
IPM501 pin29-pin8	X		No hazard, not normal operation	P
IPM501 pin30-pin8	X		No hazard, not normal operation	P
IPM501 pin30-pin21	X		No hazard, not normal operation	P
IPM501 pin30-pin26	X		No hazard, not normal operation	P
IPM501 pin21-pin26	X		No hazard, not normal operation	P
Outdoor controller for E				
ZR1	X		No hazard, fuse broken	P
ZR2	X		No hazard, fuse broken	P
BR1 pin 1-2	X		No hazard, not normal operation	P
BR1 pin 1-4	X		No hazard, not normal operation	P
Q601 pin b -pin e	X		No hazard, not normal operation	P
Q601 pin b -pin g	X		No hazard, not normal operation	P
Q601 pin e -pin g	X		No hazard, not normal operation	P
E2	X		No hazard, fuse broken	P
T1 pin 1-pin 3	X		No hazard, not normal operation	P
T1 pin 4-pin 5	X		No hazard, not normal operation	P
T1 pin 6-pin 7	X		No hazard, not normal operation	P
T1 pin 9- pin 10	X		No hazard, not normal operation	P
D402	X		No hazard, not normal operation	P

## IEC 60335-2-40

E401	X		No hazard, not normal operation	P
IC 401 pin5-pin2	X		No hazard, not normal operation	P
IC 401 pin7-pin2	X		No hazard, not normal operation	P
IC 401 pin4-pin2	X		No hazard, not normal operation	P
IC403 pin 1- pin 2	X		No hazard, not normal operation	P
IC403 pin 3-pin 4	X		No hazard, not normal operation	P
IC403 pin3	X		No hazard, not normal operation	P
D404	X		No hazard, not normal operation	P
E409	X		No hazard, not normal operation	P
D403	X		No hazard, not normal operation	P
E404	X		No hazard, not normal operation	P
IPM1 pin2-pin16	X		No hazard, not normal operation	P
IPM1 pin3-pin16	X		No hazard, not normal operation	P
IPM1 pin4-pin16	X		No hazard, not normal operation	P
IPM1 pin5-pin16	X		No hazard, not normal operation	P
IPM1 pin6-pin16	X		No hazard, not normal operation	P
IPM1 pin7-pin16	X		No hazard, not normal operation	P
IPM1 pin10-pin16	X		No hazard, not normal operation	P
IPM1 pin11-pin16	X		No hazard, not normal operation	P
IPM1 pin12-pin16	X		No hazard, not normal operation	P
IPM1 pin14-pin16	X		No hazard, not normal operation	P
IPM1 pin15-pin16	X		No hazard, not normal operation	P
IPM1 pin18-pin16	X		No hazard, not normal operation	P
IPM1 pin21-pin16	X		No hazard, not normal operation	P
IPM1 pin22-pin16	X		No hazard, not normal operation	P
IPM1 pin23-pin16	X		No hazard, not normal operation	P
IPM1 pin24-pin16	X		No hazard, not normal operation	P
IPM1 pin22-pin21	X		No hazard, not normal operation	P
IPM1 pin22-pin23	X		No hazard, not normal operation	P
IPM1 pin21-pin23	X		No hazard, not normal operation	P
IPM501 pin1-pin12	X		No hazard, not normal operation	P
IPM501 pin3-pin12	X		No hazard, not normal operation	P

## IEC 60335-2-40

IPM501 pin4-pin12	X		No hazard, not normal operation	P
IPM501 pin5-pin12	X		No hazard, not normal operation	P
IPM501 pin6-pin12	X		No hazard, not normal operation	P
IPM501 pin7-pin12	X		No hazard, not normal operation	P
IPM501 pin8-pin12	X		No hazard, not normal operation	P
IPM501 pin9-pin12	X		No hazard, not normal operation	P
IPM501 pin13-pin12	X		No hazard, not normal operation	P
IPM501 pin14-pin12	X		No hazard, not normal operation	P
IPM501 pin15-pin12	X		No hazard, not normal operation	P
IPM501 pin19-pin12	X		No hazard, not normal operation	P
IPM501 pin20-pin12	X		No hazard, not normal operation	P
IPM501 pin23-pin12	X		No hazard, not normal operation	P
IPM501 pin24-pin12	X		No hazard, not normal operation	P
IPM501 pin26-pin12	X		No hazard, not normal operation	P
IPM501 pin28-pin12	X		No hazard, not normal operation	P
IPM501 pin30-pin12	X		No hazard, not normal operation	P
IPM501 pin31-pin12	X		No hazard, not normal operation	P
IPM501 pin31-pin35	X		No hazard, not normal operation	P
IPM501 pin31-pin24	X		No hazard, not normal operation	P
IPM501 pin35-pin24	X		No hazard, not normal operation	P

<b>19.14-1</b>	<b>TABLE: Abnormal operation, temperature rises Model A</b>		P
Thermocouple locations	Max. temperature rise measured, $\Delta T$ (K)	Max. temperature rise limit, $\Delta T$ (K)	
Enclosure	42,7°C	175°C	
Test corner	43,3°C	175°C	
Supplementary information:			
1. For 19.5, the fault condition will render the protection of compressor protector and interrupt of operation or normal operation, no hazard was found.			
2. For 19.7, the appliances were operated normally and no hazard was found			
3. For 19.10/19.11, the fault conditions:			
1) Open/ short-circuit fan motor capacitor and motor compressor were simulated; the most unfavorable test results were recorded.			
2) Short-circuit the cut-out sensors or communication lines, appliance can not operate, no hazard was found.			
The most unfavourable test results were recorded.			

## IEC 60335-2-40

19.14-2	TABLE: Abnormal operation, temperature rises Model B		P
Thermocouple locations	Max. temperature rise measured, $\Delta T$ (K)	Max. temperature rise limit, $\Delta T$ (K)	
Enclosure	43,6°C	175°C	
Test corner	42,3°C	175°C	
<p>Supplementary information:</p> <ol style="list-style-type: none"> <li>1. For 19.5, the fault condition will render the protection of compressor protector and interrupt of operation or normal operation, no hazard was found.</li> <li>2. For 19.7, the appliances were operated normally and no hazard was found</li> <li>3. For 19.10/19.11, the fault conditions:               <ol style="list-style-type: none"> <li>1) Open/ short-circuit fan motor capacitor and motor compressor were simulated; the most unfavorable test results were recorded.</li> <li>2) Short-circuit the cut-out sensors or communication lines, appliance can not operate, no hazard was found.</li> </ol> </li> </ol> <p>The most unfavourable test results were recorded.</p>			

19.14-3	TABLE: Abnormal operation, temperature rises Model C		P
Thermocouple locations	Max. temperature rise measured, $\Delta T$ (K)	Max. temperature rise limit, $\Delta T$ (K)	
Enclosure	34,0°C	175°C	
Test corner	42,1°C	175°C	
<p>supplementary information:</p> <ol style="list-style-type: none"> <li>1. For 19.5, the fault condition will render the protection of compressor protector and interrupt of operation or normal operation, no hazard was found.</li> <li>2. For 19.7, the appliances could not operate in low-temp. ambient and operated normally in high-temp. ambient according to standard and no hazard was found.</li> <li>3. For 19.10/ 19.11, the fault conditions:               <ol style="list-style-type: none"> <li>1) Open/ short-circuit fan motor capacitor and motor compressor were simulated; the most unfavorable test results were recorded.</li> <li>2) Short-circuit the cut-out sensors or communication lines, appliance cannot operate, no hazard was found.</li> </ol> </li> </ol> <p>The most unfavourable test results were recorded.</p>			

## IEC 60335-2-40

19.14-4	TABLE: Abnormal operation, temperature rises Model D		P
Thermocouple locations	Max. temperature rise measured, $\Delta T$ (K)	Max. temperature rise limit, $\Delta T$ (K)	
Enclosure	41,3°C	175°C	
Test corner	42,3°C	175°C	
<p>supplementary information:</p> <ol style="list-style-type: none"> <li>1. For 19.5, the fault condition will render the protection of compressor protector and interrupt of operation or normal operation, no hazard was found.</li> <li>2. For 19.7, the appliances could not operate in low-temp. ambient and operated normally in high-temp. ambient according to standard and no hazard was found.</li> <li>3. For 19.10/ 19.11, the fault conditions:               <ol style="list-style-type: none"> <li>1) Open/ short-circuit fan motor capacitor and motor compressor were simulated; the most unfavorable test results were recorded.</li> <li>2) Short-circuit the cut-out sensors or communication lines, appliance cannot operate, no hazard was found.</li> </ol> </li> </ol> <p>The most unfavourable test results were recorded.</p>			

19.14-5	TABLE: Abnormal operation, temperature rises Model E		P
Thermocouple locations	Max. temperature rise measured, $\Delta T$ (K)	Max. temperature rise limit, $\Delta T$ (K)	
Enclosure	42,3°C	175°C	
Test corner	42,6°C	175°C	
<p>supplementary information:</p> <ol style="list-style-type: none"> <li>1. For 19.5, the fault condition will render the protection of compressor protector and interrupt of operation or normal operation, no hazard was found.</li> <li>2. For 19.7, the appliances could not operate in low-temp. ambient and operated normally in high-temp. ambient according to standard and no hazard was found.</li> <li>3. For 19.10/ 19.11, the fault conditions:               <ol style="list-style-type: none"> <li>1) Open/ short-circuit fan motor capacitor and motor compressor were simulated; the most unfavorable test results were recorded.</li> <li>2) Short-circuit the cut-out sensors or communication lines, appliance cannot operate, no hazard was found.</li> </ol> </li> </ol> <p>The most unfavourable test results were recorded.</p>			

## IEC 60335-2-40

19.14-6	TABLE: Abnormal operation, temperature rises Model H		P
Thermocouple locations	Max. temperature rise measured, $\Delta T$ (K)	Max. temperature rise limit, $\Delta T$ (K)	
Enclosure	59,8°C	175°C	
Test corner	59,4°C	175°C	
supplementary information: 1. For 19.5, the fault condition will render the protection of compressor protector and interrupt of operation or normal operation, no hazard was found. 2. For 19.7, the appliances could not operate in low-temp. ambient and operated normally in high-temp. ambient according to standard and no hazard was found. 3. For 19.10/ 19.11, the fault conditions: 1) Open/ short-circuit fan motor capacitor and motor compressor were simulated; the most unfavorable test results were recorded. 2) Short-circuit the cut-out sensors or communication lines, appliance cannot operate, no hazard was found. The most unfavourable test results were recorded.			

21.1	TABLE: Impact resistance			P
Impacts per surface	Surface tested	Impact energy (Nm)	Comments	
3	Enclosure	0,5 J	Pass	
3	Display PCB box	0,5 J	Pass	
3	Handle	0,5 J	Pass	
3	Fan guard	0,5 J	Pass	
Supplementary information:				

24.1	TABLE: Critical components information					P
Object / part No.	Manufacturer/ trademark	Type / model	Technical data	Standard	Mark(s) of conformity <sup>1)</sup>	
Indoor controller for A, A1, B, B1, C, C1, D, D1, F, F1, G, H, G1, H1	GD Midea Air-Conditioning Equipment Co., Ltd.	KFR-26G/BP3DN1Y-AG.JD.GN.WX NK.NP1	220-240VAC; 50Hz	EN 60335-2-40 EN 60335-1	Test with appliance	
Indoor controller for E, E1	GD Midea Air-Conditioning Equipment Co., Ltd.	EU-KFR70G/BP3N 8Y-AGD(C5)-GW.JD.GN.WX NK.NK2.2(0.5W /EE0/DY-BUZ)	220-240VAC; 50Hz	EN 60335-2-40 EN 60335-1	Test with appliance	
Outdoor controller for A, A1, B, B1, C, C1, D, D1, F, F1	GD Midea Air-Conditioning Equipment Co., Ltd.	KFR-35W/BP3N-(RX24Tmini+ST R6A161+GIB10 CH60TS-L+TDP4204F). D.13.WP2-1	220-240VAC; 50Hz	EN 60335-2-40 EN 60335-1	Test with appliance	

## IEC 60335-2-40

Outdoor controller for E, E1	GD Midea Air-Conditioning Equipment Co., Ltd.	KFR-72W/BP3-(RX24Tmini+6A161+PSS30S92 F6-AG+6822+LMS R).D.13.WP2-1	220-240VAC; 50Hz	EN 60335-2-40 EN 60335-1	Test with appliance
Outdoor controller for G, H, G1, H1	GD Midea Air-Conditioning Equipment Co., Ltd.	KFR-35W/BP3N-(RX24Tmini+STR6A161+GIB10CH60TS-L+TPD4204F).D.13.WP2-1	220-240VAC; 50Hz	EN 60335-2-40 EN 60335-1	Test with appliance
Compressor for A, A1, C1, C	Guangdong Meizhi Compressor Co., Ltd. (GMCC)	KSK103D33UE Z3	DC 180 V; at 180Hz; R32	EN 60335-2-34 EN 60335-2-40 EN 60335-1	TUV R 50393252 Test with appliance
Compressor for B, B1, F, F1	Guangdong Meizhi Compressor Co., Ltd. (GMCC)	KSN98D22UFZ	DC 170 V; at 180Hz; R32	EN 60335-2-34 EN 60335-2-40 EN 60335-1	CCC 2013010704 637836 Test with appliance
Compressor for D, D1	Guangdong Meizhi Compressor Co., Ltd. (GMCC)	KSN140D21UF Z	DC 160 V; at 180Hz; R32	EN 60335-2-34 EN 60335-2-40 EN 60335-1	TUV R 50393252 Test with appliance
Compressor for E, E1	Guangdong Meizhi Compressor Co., Ltd. (GMCC)	KTM240D57UM T	DC 156 V; at 180Hz; R32	EN 60335-2-34 EN 60335-2-40 EN 60335-1	TUV R 50393252 Test with appliance
Compressor for G, H, G1, H1	Guangdong Meizhi Compressor Co., Ltd. (GMCC)	KSN98D64UFZ 3	275 V; at 180 Hz; R32	EN 60335-2-34 EN 60335-2-40 EN 60335-1	TUV R 50393252 Test with appliance
Indoor fan motor for A, A1	Guangdong Welling Motor Manufacturing Co., Ltd. (Welling)	WZDK20-38G (ZKFP-20-8-6)	DC280V; 20W; Class E	EN 60335-2-40 EN 60335-1	Test with appliance
(Alternative)	Jiangsu Sanjiang Electric Group Co., Ltd.	ZKFP-20-8-6 (MDZW003/ZW D-20)	DC310V, 20W, ClassE	EN 60335-2-40 EN 60335-1	Test with appliance
(Alternative)	Shishishi Tongda Motor Co., Ltd	ZKFP-20-8-6 (ZYTM93-3100024A)	DC310V, 20W, ClassE	EN 60335-2-40 EN 60335-1	Test with appliance
Indoor fan motor for B, B1, C, C1, F, F1, G, H, G1, H1	Guangdong Welling Motor Manufacturing Co., Ltd. (Welling)	WZDK13-38G-1 (RD-310-13-8) (ZKFP-13-8-4)	DC310V; 13W; Class E	EN 60335-2-40 EN 60335-1	Test with appliance
(Alternative)	Jiangsu Sanjiang Electric Group Co., Ltd.	ZKFP-13-8-4	DC310V; 13W; Class E	EN 60335-2-40 EN 60335-1	Test with appliance
(Alternative)	Shishishi Tongda Motor Co., Ltd	ZKFP-13-8-4	DC310V; 13W; Class E	EN 60335-2-40 EN 60335-1	Test with appliance
(Alternative)	NIDEC SHIBAURA(ZHEJIAN)CO.,LTD	ZKFP-13-8-4	DC310V; 13W; Class E	EN 60335-2-40 EN 60335-1	Test with appliance

## IEC 60335-2-40

(Alternative)	Wolong Electric Group Co., Ltd	ZKFP-13-8-4	DC310V; 13W; Class E	EN 60335-2-40 EN 60335-1	Test with appliance
Indoor fan motor for D, D1	Zhongshan Broad-Ocean Motor Co., Ltd	WZDK30-38G (ZWK465A00302) (ZKFP-30-8-3)	DC310V; 30W; Class E	EN 60335-2-40 EN 60335-1	Test with appliance
(Alternative)	Guangdong Welling Motor Manufacturing Co., Ltd. (Welling)	WZDK30-38G (RD-310-30-8T) (ZKFP-30-8-3)	DC310V; 30W; Class E	EN 60335-2-40 EN 60335-1	Test with appliance
(Alternative)	Nidec Shibaura (Zhejiang) Corp.	ZKFP-30-8-3	DC310V; 30W; Class E	EN 60335-2-40 EN 60335-1	Test with appliance
Indoor fan motor for E, E1	Zhongshan Broad-Ocean Motor Co., Ltd	WZDK58-38G (ZKFP-58-8-1)	DC310V; 60W; Class E	EN 60335-2-40 EN 60335-1	Test with appliance
(Alternative)	Nidec Shibaura (Zhejiang) Corp.	WZDK58-38G (ZKFP-58-8-1)	DC310V; 58W; Class E	EN 60335-2-40 EN 60335-1	Test with appliance
(Alternative)	Guangdong Welling Motor Manufacturing Co., Ltd.	WZDK58-38G (ZKFP-58-8-1)	DC310V; 58W; class E	EN 60335-1 EN 60335-2-40	Test with appliance
Outdoor fan motor for A, A1, C, C1	Zhongshan Broad-Ocean Motor Co., Ltd	ZKFN-20-8-1 (WZDK20-38G-W) (ZW465A003)	DC310V,20W Class E	EN 60335-2-40 EN 60335-1	Test with appliance
(Alternative)	Guangdong Welling Motor Manufacturing Co., Ltd. (Welling)	ZKFN-20-8-1 (WZDK20-38G-W) (RDN-310-20-8)	DC310V; 20W; Class E	EN 60335-2-40 EN 60335-1	Test with appliance
(Alternative)	Shishishi Tongda Motor Co., Ltd.	ZKFN-20-8-1 (WZDK20-38G-W)	DC310V; 20W; Class E	EN 60335-2-40 EN 60335-1	Test with appliance
(Alternative)	JEAMO MOTOR CO.,LTD.	ZKFN-20-8-1	DC310V; 20W; Class E	EN 60335-2-40 EN 60335-1	Test with appliance
Outdoor fan motor for B, B1, D, D1, F, F1	Guangdong Welling Motor Manufacturing Co., Ltd. (Welling)	ZKFN-34-10-1	DC310V; 80W; Class E	EN 60335-2-40 EN 60335-1	Test with appliance
(Alternative)	Shishishi Tongda Motor Co., Ltd.	ZKFN-34-10-1	DC310V; 80W; Class E	EN 60335-2-40 EN 60335-1	Test with appliance
(Alternative)	Nidec Shibaura (Zhejiang) Corp.	ZKFN-34-10-1	DC310V; 80W; Class E	EN 60335-2-40 EN 60335-1	Test with appliance
Outdoor fan motor for E, E1	Zhongshan Broad-Ocean Motor Co., Ltd	ZKFN-80-8-3 (WZDK80-38G-W(A))(RDN-310-80-8B)	DC310V,80W Class E	EN 60335-2-40 EN 60335-1	Test with appliance
(Alternative)	Guangdong Welling Motor Manufacturing Co., Ltd. (Welling)	ZKFN-80-8-3 (WZDK80-38G-W(A))(RDN-310-80-8B)	DC310V; 80W; Class E	EN 60335-2-40 EN 60335-1	Test with appliance
(Alternative)	Shishishi Tongda Motor Co., Ltd.	ZKFN-80-8-3(WZDK80-38G-W(A))	DC310V; 80W; Class E	EN 60335-2-40 EN 60335-1	Test with appliance
Outdoor fan motor for G, H, G1, H1	Guangdong Welling Motor Manufacturing Co., Ltd.	ZKFN-34-10-1	DC310V; 34W; Class B	EN 60335-2-40 EN 60335-1	Test with appliance
(Alternative)	Zhongshan Broad-Ocean Motor Co., Ltd.	ZKFN-34-10-1	DC310V; 34W; Class B	EN 60335-2-40 EN 60335-1	Test with appliance

## IEC 60335-2-40

(Alternative)	Shishishi Tongda Motor Co., Ltd	ZKFN-34-10-1	DC310V; 34W; Class B	EN 60335-2-40 EN 60335-1	Test with appliance
(Alternative)	Nidec Shibaura (Zhejiang) Corp.	ZKFN-34-10-1	DC310V; 34W; Class B	EN 60335-2-40 EN 60335-1	Test with appliance
Indoor transformer for A, A1, B, B1, C, C1, D, D1, F, F1, G, H, G1, H1	Hui Zhou Jia Yang Core New-Tech Co., Ltd. /Wu Han Chen Yang Core New-Tech Co., Ltd.	EE2515K222(E E25(5+5)2/P5-0.547L1)	EE25; input: 85VAC-265VAC; output: 12V/1200mA; 17V/100mA; Class B	EN 60335-2-40 EN 60335-1	Test with appliance
(Alternative)	Weimei Electronics Factory Dong Guan City (Wm)	EE25(5+5)2/P5-0.547L1	EE25; input: 85VAC-265VAC; output: 12V/1200mA; 17V/100mA; Class B	EN 60335-2-40 EN 60335-1	Test with appliance
(Alternative)	Shekou Jewel Electronic Co., Ltd. Guangxi Rongxian Jewel Electronic Co., Ltd.	EE25(5+5)2/P5-0.547L1	EE25; input: 85VAC-265VAC; output: 12V/1200mA; 17V/100mA; Class B	EN 60335-2-40 EN 60335-1	Test with appliance
(Alternative)	Shunde Zhanliang Industrial Co., Ltd	EE25(5+5)2/P5-0.547L1 (EE2515K222)	EE25; input: 85VAC-265VAC; output: 12V/1200mA; 17V/100mA; Class B	EN 60335-2-40 EN 60335-1	Test with appliance
Indoor transformer for E, E1	Huizhou Jiayang Core New-Tech Co., Ltd. Wuyan Chenyang Core New-Tech Co., Ltd.	E22084(EE22(5+5)2/P4-1.52L2)	EE22; input: 212,1~373,3 VDC; output: 12~21V; 12V; 1000mA; 18,5~19,5V/200mA Class B	EN 60335-2-40 EN 60335-1	Test with appliance
(Alternative)	Shekou Jewel Electronic Co., Ltd. Guangxi Rongxian Jewel Electronic Co., Ltd.	E22084(EE22(5+5)2/P4-1.52L2)	EE22; input: 212,1~373,3VDC; output: 12~21V; 12V 1000mA; 18,5~19,5V/200mA Class B	EN 60335-2-40 EN 60335-1	Test with appliance
(Alternative)	Hefei Phoenix Electronics Technology Co., Ltd.	E22084(EE22(5+5)2/P4-1.52L2)	EE22; input: 212,1~373,3VDC; output: 12~21V; 12V 1000mA; 18,5~19,5V/200mA Class B	EN 60335-2-40 EN 60335-1	Test with appliance
Outdoor transformer for A, A1, B, B1, C, C1, D, D1, E, E1, F, F1	Shunde Zhanliang Industrial Co., Ltd Foshan City Shunde District Zhanliang Industrial Co., Ltd	EE22(5+4)3P4-1.1L5	EE22; input: 110V~264V; output: 12V±5% 800mA; 12V±5% 400mA; 15V±5% 100mA; Class B	EN 60335-2-40 EN 60335-1	Test with appliance

## IEC 60335-2-40

(Alternative)	Guangxi Rongxian Jewel Electronic Co., Ltd. / Shekou Jewel Electronic Co., Ltd.	EE22(5+4)3P4-1.1L5	EE22; input: 110V~264V; output: 12V±5% 800mA; 12V±5% 400mA; 15V±5% 100mA; Class B	EN 60335-2-40 EN 60335-1	Test with appliance
(Alternative)	Hui Zhou Jia Yang Core New-Tech Co., Ltd. Wu Han Chen Yang Core New-Tech Co., Ltd.	EE22(5+4)3P4-1.1L5	EE22; input: 110V~264V; output: 12V±5% 800mA; 12V±5% 400mA; 15V±5% 100mA; Class B	EN 60335-2-40 EN 60335-1	Test with appliance
(Alternative)	Weimei Electronics Factory Dong Guan City (Wm)	EE22(5+4)3P4-1.1L5	EE22; input: 110V~264V; output: 12V±5% 800mA; 12V±5% 400mA; 15V±5% 100mA; Class B	EN 60335-2-40 EN 60335-1	Test with appliance
Outdoor transformer for G, H, G1, H1	Guangxi Rongxian Jewel Electronic Co., Ltd.	EE22(5+4)3P4-1.1L5	EE22; input: 110V~264V; output: 12V±5% 800mA; 12V±5% 400mA; 15V±5% 100mA; Class B	EN 60335-2-40 EN 60335-1	Test with appliance
(Alternative)	Mingguang City Ruichuang Electrica Co., Ltd.	EE22(5+4)3P4-1.1L5	EE22; input: 110V~264V; output: 12V±5% 800mA; 12V±5% 400mA; 15V±5% 100mA; Class B	EN 60335-2-40 EN 60335-1	Test with appliance
(Alternative)	Huizhou Jiayang Electronic Core New-Tech Co., Ltd.	EE22(5+4)3P4-1.1L5	EE22; input: 110V~264V; output: 12V±5% 800mA; 12V±5% 400mA; 15V±5% 100mA; Class B	EN 60335-2-40 EN 60335-1	Test with appliance
(Alternative)	Weimei Electronics Factory Guan City (Wm)	EE22(5+4)3P4-1.1L5	EE22; input: 110V~264V; output: 12V±5% 800mA; 12V±5% 400mA; 15V±5% 100mA; Class B	EN 60335-2-40 EN 60335-1	Test with appliance
(Alternative)	Foshan City Shunde District Zhanliang Industrial Co., Ltd.	EE22(5+4)3P4-1.1L5	EE22; input: 110V~264V; output: 12V±5% 800mA; 12V±5% 400mA; 15V±5% 100mA; Class B	EN 60335-2-40 EN 60335-1	Test with appliance
Step motor I for A, A1, B, B1, C, C1, F, F1, G, H, G1, H1	Jiangsu Leili Motor Co., Ltd.	SM-24-19-16-8 (MP24GA5)	DC12V; Class E	EN 60335-2-40 EN 60335-1	Test with appliance
(Alternative)	Guangdong Whilip Intelligent Technology Co., Ltd.	SM-24-19-16-8 (MP24GA5)	DC12V; Class E	EN 60335-2-40 EN 60335-1	Test with appliance

## IEC 60335-2-40

(Alternative)	Hefei Huilipu Motor Co., Ltd	SM-24-19-16-8 (MP24GA5)	DC12V; Class E	EN 60335-2-40 EN 60335-1	Test with appliance
(Alternative)	Changzhou Ouck Electric Co., Ltd.	SM-24-19-16-8 (MP24GA5)	DC12V; Class E	EN 60335-2-40 EN 60335-1	Test with appliance
(Alternative)	Jiangsu Huayang Electric Co., Ltd.	SM-24-19-16-8 (MP24GA5)	DC12V; Class E	EN 60335-2-40 EN 60335-1	Test with appliance
(Alternative)	Shen Zhen City Oncetop Motor Manufacture Co., Ltd.	SM-24-19-16-8/MP24GA5/24B YJ48-D1	DC12V; Class E	EN 60335-2-40 EN 60335-1	Test with appliance
Step motor II for A, A1, B, B1, C, C1, F, F1, G, H, G1, H1	Jiangsu Huayang Electric Co., Ltd.	SM-24-19-16-89	DC12V; Class E	EN 60335-2-40 EN 60335-1	Test with appliance
(Alternative)	Guangdong Whilip Intelligent Technology Co., Ltd.	SM-24-19-16-89	DC12V; Class E	EN 60335-2-40 EN 60335-1	Test with appliance
(Alternative)	Guangdong Whilip Intelligent Technology Co., Ltd.	SM-24-19-16-89	DC12V; Class E	EN 60335-2-40 EN 60335-1	Test with appliance
(Alternative)	Huayang Intelligent Equipment Co., Ltd.	SM-24-19-16-89	DC12V; Class E	EN 60335-2-40 EN 60335-1	Test with appliance
(Alternative)	Jiangsu Leili Motor Co., Ltd.	SM-24-19-16-89	DC12V; Class E	EN 60335-2-40 EN 60335-1	Test with appliance
(Alternative)	Changzhou Ouck Electric Co., Ltd.	SM-24-19-16-89	DC12V; Class E	EN 60335-2-40 EN 60335-1	Test with appliance
(Alternative)	Shen Zhen City Oncetop Motor Manufacture Co., Ltd.	SM-24-19-16-89	DC12V; Class E	EN 60335-2-40 EN 60335-1	Test with appliance
Step motor I for D, D1	Changzhou Ouck Electric Co., Ltd.	SM-30-17-12-15	DC12V; Class E	EN 60335-2-40 EN 60335-1	Test with appliance
(Alternative)	Jiangsu Huayang Electric Co., Ltd.	SM-30-17-12-15	DC12V; Class E	EN 60335-2-40 EN 60335-1	Test with appliance
(Alternative)	Jiangsu Leili Motor Co., Ltd.	SM-30-17-12-15	DC12V; Class E	EN 60335-2-40 EN 60335-1	Test with appliance
(Alternative)	Guangdong Whilip Intelligent Technology Co., Ltd.	SM-30-17-12-15	DC12V; Class E	EN 60335-2-40 EN 60335-1	Test with appliance
(Alternative)	Hefei Huilipu Motor Co., Ltd	SM-30-17-12-15	DC12V; Class E	EN 60335-2-40 EN 60335-1	Test with appliance
(Alternative)	Shen Zhen City Oncetop Motor Manufacture Co., Ltd	SM-30-17-12-15	DC12V; Class E	EN 60335-2-40 EN 60335-1	Test with appliance
Step motor II for D, D1	Guangdong Whilip Intelligent Technology Co., Ltd.	SM-24-19-16-42 /MP24GA16	DC12V; Class E	EN 60335-2-40 EN 60335-1	Test with appliance
(Alternative)	Changzhou Ouck Electric Co., Ltd.	SM-24-19-16-42 /MP24GA16	DC12V; Class E	EN 60335-2-40 EN 60335-1	Test with appliance
(Alternative)	Jiangsu Huayang Electric Co., Ltd.	SM-24-19-16-42 /MP24GA16	DC12V; Class E	EN 60335-2-40 EN 60335-1	Test with appliance
(Alternative)	Shen Zhen City Oncetop Motor Manufacture Co., Ltd.	SM-24-19-16-42 (MP24GA16) (24BYJ48-D2)	DC12V; Class E	EN 60335-2-40 EN 60335-1	Test with appliance

## IEC 60335-2-40

(Alternative)	Jiangsu Leili Motor Co., Ltd.	SM-24-19-16-42 /MP24GA16	DC12V; Class E	EN 60335-2-40 EN 60335-1	Test with appliance
(Alternative)	Hefei Huilipu Motor Co., Ltd	SM-24-19-16-42 /MP24GA16	DC12V; Class E	EN 60335-2-40 EN 60335-1	Test with appliance
Step motor I for E, E1	Guangdong Whilip Intelligent Technology Co., Ltd.	SM-30-17-12-14 (MP30EA10)	DC12V; Class E	EN 60335-2-40 EN 60335-1	Test with appliance
(Alternative)	Hefei Whilip Intelligent Technology Co., Ltd.	SM-30-17-12-14 (30BYJ46-A08)	DC12V; Class A	EN 60335-2-40 EN 60335-1	Test with appliance
(Alternative)	Changzhou Ouck Electric Co., Ltd.	SM-30-17-12-14 (MP30EA10)	DC12V; Class E	EN 60335-2-40 EN 60335-1	Test with appliance
(Alternative)	Jiangsu Huayang Electric Co., Ltd.	SM-30-17-12-14(MP30EA10)	DC12V; Class E	EN 60335-2-40 EN 60335-1	Test with appliance
(Alternative)	Shen Zhen City Oncetop Motor Manufacture Co., Ltd.	SM-30-17-12-14 (MP30EA10)	DC12V; Class E	EN 60335-2-40 EN 60335-1	Test with appliance
(Alternative)	Jiangsu Leili Motor Co., Ltd.	SM-30-17-12-14 (MP30EA10)	DC12V; Class E	EN 60335-2-40 EN 60335-1	Test with appliance
(Alternative)	Hefei Huilipu Motor Co., Ltd	SM-30-17-12-14 (MP30EA10)	DC12V; Class E	EN 60335-2-40 EN 60335-1	Test with appliance
Step motor II for E, E1	Guangdong Whilip Intelligent Technology Co., Ltd.	SM-24-19-16-42 (MP24GA16)	DC12V; Class E	EN 60335-2-40 EN 60335-1	Test with appliance
(Alternative)	Changzhou Ouck Electric Co., Ltd.	SM-24-19-16-42 (MP24GA16)	DC12V; Class E	EN 60335-2-40 EN 60335-1	Test with appliance
(Alternative)	Jiangsu Huayang Electric Co., Ltd.	SM-24-19-16-42 (MP24GA16)	DC12V; Class E	EN 60335-2-40 EN 60335-1	Test with appliance
(Alternative)	Shen Zhen City Oncetop Motor Manufacture Co., Ltd.	SM-24-19-16-42 (MP24GA16) (24BYJ48-D2)	DC12V; Class E	EN 60335-2-40 EN 60335-1	Test with appliance
(Alternative)	Jiangsu Leili Motor Co., Ltd.	SM-24-19-16-42 (MP24GA16)	DC12V; Class E	EN 60335-2-40 EN 60335-1	Test with appliance
(Alternative)	Hefei Huilipu Motor Co., Ltd	SM-24-19-16-42 (MP24GA16)	DC12V; Class E	EN 60335-2-40 EN 60335-1	Test with appliance
Indoor fuse for A, A1, C, C1, D, D1, E, E1	Hollyland (China) Electronics Technology Corporation Ltd.	50CT	T 5A; 250V	EN 60127-1 EN 60127-2	VDE 40014896
(Alternative)	Dongguan Better Electronic Technology Co., Ltd.	524	T 5A; 250VAC	EN 60127-1 EN 60127-2	VDE 40025424
(Alternative)	Hollyland (Xiamen) Technology Corporation Limited	50CT	T 5A; 250V	EN 60127-1 EN 60127-2	VDE 40014896
(Alternative)	XC Electronics (Shenzhen) Corporation Limited	5H	T 5A; 250V	EN 60127-1 EN 60127-2	VDE: 40037020
Indoor fuse for B, B1, F, F1, G, H, G1, H1	Hollyland (China) Electronics Technology Corporation Limited.	50CT	T 3,15A; 250V	EN 60127-1 EN 60127-2	VDE 40014869
(Alternative)	Dongguan Better Electronic Technology Co., Ltd.	334	T 3,15A; 250V	EN 60127-1 EN 60127-2	VDE 40025428

## IEC 60335-2-40

(Alternative)	Xucheng Electronics (Shenzhen) Co., Ltd	4T	T 3,15A; 250V	IEC 60127-1 IEC 60127-2	VDE: 40029295
(Alternative)	Hollyland (Xiamen) Technology Corporation Limited	50CT	T 3,15A; 250V	EN 60127-1 EN 60127-2	VDE 40014869
Outdoor fuse for A, A1, B, B1, C, C1, D, D1, F, F1	Dongguan Better Electronic Technology Co., Ltd.	614	T 20A; 250V	EN 60335-2-40 EN 60335-1	Test with appliance
(Alternative)	Shanghai Songshan Electronics Co., Ltd.	326	T 20A, 250VAC	EN 60335-2-40 EN 60335-1	Test with appliance
(Alternative)	XC Electronics (Shenzhen) Corporation Limited	6H	T 20A; 250VAC	EN 60335-2-40 EN 60335-1	Test with appliance
(Alternative)	Hollyland (Xiamen) Technology Corporation Limited	65TS	T 20A; 250VAC	EN 60335-2-40 EN 60335-1	Test with appliance
Outdoor fuse for G, H, G1, H1	Hollyland (Xiamen) Technology Corporation Limited	65TS	T 20A; 250VAC	EN 60335-2-40 EN 60335-1	Test with appliance
(Alternative)	Dongguan Better Electronic Technology Co., Ltd.	614	T 20A; 250VAC	EN 60335-2-40 EN 60335-1	Test with appliance
(Alternative)	Dongguan Better Electronic Technology Co., Ltd.	614	T 20A; 250VAC	EN 60335-2-40 EN 60335-1	Test with appliance
(Alternative)	Xucheng Electronics (Shenzhen) Co., Ltd	6H	T 20A; 250VAC	EN 60335-2-40 EN 60335-1	Test with appliance
(Alternative)	Shanghai Songshan Electronics Co., Ltd.	326	T 20A; 250VAC	EN 60335-2-40 EN 60335-1	Test with appliance
Outdoor fuse for E, E1	Hollyland (China) Electronics Technology Corporation Limited.	65TS	T 30A; 250VAC	EN 60335-2-40 EN 60335-1	Test with appliance
(Alternative)	Dongguan Better Electronic Technology Co., Ltd.	614	T 30A; 250V	EN 60335-2-40 EN 60335-1	Test with appliance
(Alternative)	Hollyland (Xiamen) Technology Corporation Limited	65TS	T 30A; 250VAC	EN 60335-2-40 EN 60335-1	Test with appliance
(Alternative)	XC Electronics (Shenzhen) Corporation Limited	6H	T 30A; 250VAC	EN 60335-2-40 EN 60335-1	Test with appliance
Indoor relay I for A, A1, B, B1, C, C1, D, D1, E, E1, F, F1, G, H, G1, H1	Dongguan Churod Electronics Co., Ltd.	A1-S-112DA	5A; 250V~/30V-; 100000 cycles; T85°C	EN 61810-1 GB 3836.1 GB 3836.8 EN 60079-0 EN 60079-15	TUV R50174892 CNEx15.04 86U
(Alternative)	Wangrong Electronics (Shenzhen) Co., Ltd.	RJ-SS-112DM-S	5A; 250VAC; 100000 cycles; T85°C	EN 61810-1 EN 60079-0 EN 60079-15	TUV R50222701 TUV SUD NO.64.105. 15.01733.01

## IEC 60335-2-40

(Alternative)	Dongguan Sanyou Electrical Appliances Co., Ltd	SJ-SH-112DM2	5A; 250VAC; 100000 cycles; T85°C	EN 61810-1 GB 3836.1 GB 3836.8 EN 60079-0 EN 60079-15	VDE 40002146 CNEx15.15 06U
(Alternative)	Omron Corporation Safety Standards Group	G5NB-1A4-E-HA	5A;250VAC; T85°C; operation cycles:100000	EN 61810-1 GB 3836.1 GB 3836.8 EN 60079-0 EN 60079-15	VDE 137575 CNEX15.26 82U
(Alternative)	Omron Electronic Components (Shenzhen) Ltd.	G5NB-1A4-E	5A, 250VAC, 100,000 cycles; T85°C	EN 61810-1 GB 3836.1 GB 3836.8 EN 60079-0 EN 60079-15	VDE 137575 CNEx15.26 82U
(Alternative)	Zhejiang Meishuo Electric Technology Co., Ltd	MPD-S-112-A	5A; 250VAC; 100000 cycles; T85°C	EN 61810-1 GB 3836.1 GB 3836.8 EN 60079-0 EN 60079-15	TUV R50184948 CNEx15.19 82U
(Alternative)	Wangrong Electronics (Shenzhen) Co., Ltd.	RC-112DM1H	5A 250VAC; 100000 cycle; T85°C	EN 61810-1 EN 60079-0 EN 60079-15	VDE 40034781
(Alternative)	TYCO Electronics (Shenzhen) Co., Ltd.	OJE-SH-112DM	5A; 250VAC; 100000 cycles; T85°C	EN 61810-1 GB 3836.1 GB 3836.8 EN 60079-0 EN 60079-15	VDE 40007630 CNEx15.11 12U
(Alternative)	Yueqing Meishuo Electric Co., Ltd	MPD-S-112-A	5A; 250VAC; T85°C; operation cycles:100000	EN 61810-1 GB 3836.1 GB 3836.8 EN 60079-0 EN 60079-15	CNEx15.198 2U TUV Rh R50184948
(Alternative)	Yueqing Meishuo Electric Co., Ltd	MPR-S-112-A	5A;250VAC; T85°C; operation cycles:100000	EN 61810-1 GB 3836.1 GB 3836.8 EN 60079-0 EN 60079-15	CNEx15.198 3U TUV Rh R50217035
(Alternative)	Dongguan Churod Electronics Co., Ltd.	CHM-S-112DA3	5A; 250VAC; 100000 cycles; T85°C	EN 61810-1 GB 3836.1 GB 3836.8 EN 60079-0 EN 60079-15	TUV: R50196152 CNEx15.048 8U
(Alternative)	Dongguan Sanyou Electrical Appliances Co., Ltd	SRB-SH-112DM2	5A; 277VAC; 100000 cycles; T85°C	EN 61810-1 GB 3836.1 GB 3836.8 EN 60079-0 EN 60079-15	VDE 40033402 CNEx15.150 9U CNEx15.152 3U
(Alternative)	TYCO Electronics (Shenzhen) Co., Ltd.	PCJ-112D3MH-WG	5A 250VAC; 100000 cycle; T85°C	EN 61810-1 GB 3836.1 GB 3836.8 EN 60079-0 EN 60079-15	VDE 40009151 CNEx16.30 73U

## IEC 60335-2-40

Indoor relay II for A, A1, B, B1, C, C1, D, D1, E, E1, F, F1, G, H, G1, H1	Dongguan Churod Electronics Co., Ltd.	CHF-S-112DA2	20A; 250VAC; 100000 cycles; T85°C	EN 61810-1 GB 3836.1 GB 3836.8 EN 60079-0 EN 60079-15	TUV R50220099 CNEx15.04 87U
(Alternative)	Wangrong Electronics (Shenzhen) Co., Ltd.	RF-SS-112DMF	20A; 250VAC; 100000 cycles; T85°C	EN 61810-1 GB 3836.1 GB 3836.8 EN 60079-0 EN 60079-15	TUV 50194013 CNEx17.17 76U
(Alternative)	Dongguan Sanyou Electrical Appliances Co., Ltd	SFK-112DM	20A; 250VAC; 100000 cycles; T85°C	EN 61810-1 GB 3836.1 GB 3836.8 EN 60079-0 EN 60079-15	VDE 40007481 CNEx15.15 02U
(Alternative)	Zhejiang Meishuo Electric Technology Co., Ltd.	MPY-S-112-A	20A; 250VAC; 100000 cycles; T85°C	EN 61810-1 GB 3836.1 GB 3836.8 EN 60079-0 EN 60079-15	TUV R50204088 CNEx15.19 80U
(Alternative)	Sanyou Corporation Limited	SFK-112DM	20A; 250VAC; 100000 cycles; T85°C	EN 61810-1 GB 3836.1 GB 3836.8 EN 60079-0 EN 60079-15	VDE 40007481 CNEx15.15 02U
Outdoor relay I for A, A1, B, B1, C, C1, D, D1, F, F1	Dongguan Churod Electronics Co., Ltd.	CHZ02-S-112LA2	16A; 250VAC; 100000 cycles; T85°C	EN 61810-1 GB 3836.1 GB 3836.8 EN 60079-0 EN 60079-15	TUV R50212872 CNEx15.048 5U
(Alternative)	Wangrong Electronics (Shenzhen) Co., Ltd.	RMIH-SS-112LM-S	16A; 250VAC; 100000 cycles; T85°C	EN 61810-1 GB 3836.1 GB 3836.8 EN 60079-0 EN 60079-15	TUV: R50242245 CNEx15.144 0U
(Alternative)	Dongguan Sanyou Electrical Appliances Co., Ltd	SMIH-SH-112LM	17A; 250VAC; 100000 cycles; T85°C	EN 61810-1 GB 3836.1 GB 3836.8 EN 60079-0 EN 60079-15	VDE 40034054 CNEx15.151 3U CNEx15.152 0U
(Alternative)	Tyco Electronics (Shenzhen) Co., Ltd.	OMIH-SH-112LM	16A; 250VAC; 100000 cycles; T85°C	EN 61810-1 GB 3836.1 GB 3836.8 EN 60079-0 EN 60079-15	TUV R50139138 CNEx15.111 3U
(Alternative)	Zhejiang Meishuo Electric Technology Co., Ltd.	MPJ-S-112-A-2	16A; 250VAC; 100000 cycles; T85°C	EN 61810-1 GB 3836.1 GB 3836.8 EN 60079-0 EN 60079-15	CNEx15.37 75U TÜV Rh R50294981

## IEC 60335-2-40

(Alternative)	Wangrong Electronics (Shenzhen) Co., Ltd.	RMIH-SS-112LM	16A; 250VAC; 100000 cycles; T105°C	EN 61810-1 GB 3836.1 GB 3836.8 EN 60079-0 EN 60079-15	TUV: R50242245 CNEx15.144 0U CNEx19.300 1U TUV AK5041995 0
Outdoor relay II for A, A1, B, B1, C, C1, D, D1, E, E1, F, F1	Dongguan Churod Electronics Co., Ltd.	A1-S-112DA	5A; 250V~/30V~; 100000 cycles; T85°C	EN 61810-1 GB 3836.1 GB 3836.8 EN 60079-0 EN 60079-15	TUV R50174892 CNEx15.04 86U
(Alternative)	Wangrong Electronics (Shenzhen) Co., Ltd.	RJ-SS-112DM-S	5A; 250VAC; 100000 cycles; T85°C	EN 61810-1 EN 60079-0 EN 60079-15	TUV R50222701 TUV SUD NO.64.105. 15.01733.01
(Alternative)	Dongguan Sanyou Electrical Appliances Co., Ltd	SJ-SH-112DM2	5A; 250VAC; 100000 cycles; T85°C	EN 61810-1 GB 3836.1 GB 3836.8 EN 60079-0 EN 60079-15	VDE 40002146 CNEx15.15 06U
(Alternative)	Omron Corporation Safety Standards Group	G5NB-1A4-E-HA	5A;250VAC; T85°C; operation cycles:100000	EN 61810-1 GB 3836.1 GB 3836.8 EN 60079-0 EN 60079-15	VDE 137575 CNEX15.26 82U
(Alternative)	Omron Electronic Components (Shenzhen) Ltd.	G5NB-1A4-E	5A, 250VAC, 100,000 cycles; T85°C	EN 61810-1 GB 3836.1 GB 3836.8 EN 60079-0 EN 60079-15	VDE 137575 CNEx15.26 82U
(Alternative)	Zhejiang Meishuo Electric Technology Co., Ltd	MPD-S-112-A	5A; 250VAC; 100000 cycles; T85°C	EN 61810-1 GB 3836.1 GB 3836.8 EN 60079-0 EN 60079-15	TUV R50184948 CNEx15.19 82U
(Alternative)	Wangrong Electronics (Shenzhen) Co., Ltd.	RC-112DM1H	5A 250VAC; 100000 cycle; T85°C	EN 61810-1 EN 60079-0 EN 60079-15	VDE 40034781
(Alternative)	TYCO Electronics (Shenzhen) Co., Ltd.	OJE-SH-112DM	5A; 250VAC; 100000 cycles; T85°C	EN 61810-1 GB 3836.1 GB 3836.8 EN 60079-0 EN 60079-15	VDE 40007630 CNEx15.11 12U
(Alternative)	Yueqing Meishuo Electric Co., Ltd	MPD-S-112-A	5A; 250VAC; T85°C; operation cycles:100000	EN 61810-1 GB 3836.1 GB 3836.8 EN 60079-0 EN 60079-15	CNEx15.198 2U TUV Rh R50184948
(Alternative)	Yueqing Meishuo Electric Co., Ltd	MPR-S-112-A	5A;250VAC; T85°C; operation cycles:100000	EN 61810-1 GB 3836.1 GB 3836.8 EN 60079-0 EN 60079-15	CNEx15.198 3U TUV Rh R50217035

## IEC 60335-2-40

(Alternative)	Dongguan Churod Electronics Co., Ltd.	CHM-S-112DA3	5A; 250VAC; 100000 cycles; T85°C	EN 61810-1 GB 3836.1 GB 3836.8 EN 60079-0 EN 60079-15	TUV: R50196152 CNEx15.048 8U
(Alternative)	Dongguan Sanyou Electrical Appliances Co., Ltd	SRB-SH-112DM2	5A; 277VAC; 100000 cycles; T85°C	EN 61810-1 GB 3836.1 GB 3836.8 EN 60079-0 EN 60079-15	VDE 40033402 CNEx15.150 9U CNEx15.152 3U
(Alternative)	TYCO Electronics (Shenzhen) Co., Ltd.	PCJ-112D3MH-WG	5A 250VAC; 100000 cycle; T85°C	EN 61810-1 GB 3836.1 GB 3836.8 EN 60079-0 EN 60079-15	VDE 40009151 CNEx16.30 73U
(Alternative)	Zhejiang Meishuo Electric Technology Co., Ltd.	MPY-S-112-A-P	20A; 250VAC/25A; 250VAC; 100000 cycles; T85°C	EN 61810-1 GB 3836.1 GB 3836.8 EN 60079-0 EN 60079-15	TUV R50204088 CNEx15.19 80U
(Alternative)	Dongguan Churod Electronics Co., Ltd.	CHFN-S-112DA2	20A; 250VAC; 100000 cycles; T85°C	EN 61810-1 GB 3836.1 GB 3836.8 EN 60079-0 EN 60079-15	TUV R50220099 CNEx15.04 87U
(Alternative)	Wangrong Electronics (shenzhen) Co., Ltd.	RF-SS-112DM	20A; 250VAC/25A; 250VAC; 100000 cycles; T85°C	EN 61810-1 EN 60079-0 EN 60079-15	TUV R50194013 TUV SUD NO.64.105. 15.01548.01
(Alternative)	Dongguan Sanyou Electrical Appliances Co., Ltd	SFK-112DMP	20A; 250VAC; 100000 cycles; T85°C	EN 61810-1 GB 3836.1 GB 3836.8 EN 60079-0 EN 60079-15	VDE 40007481 CNEx15.15 02U
(Alternative)	Wangrong Electronics (Shenzhen) Co., Ltd.	RF-SS-112DMF	20A 250VAC; 100000 cycle; T85°C	EN 61810-1 GB 3836.1 GB 3836.8 EN 60079-0 EN 60079-15	TUV 50194013 CNEx17.17 76U
(Alternative)	Dongguan Churod Electronics Co., Ltd.	CHF-S-112DA2	20A; 250VAC; 100000 cycles; T85°C	EN 61810-1 GB 3836.1 GB 3836.8 EN 60079-0 EN 60079-15	TUV R50220099 CNEx15.04 87U
(Alternative)	Dongguan Sanyou Electrical Appliances Co., Ltd	SFK-112DM	20A; 250VAC; 100000 cycles; T85°C	EN 61810-1 GB 3836.1 GB 3836.8 EN 60079-0 EN 60079-15	VDE 40007481 CNEx15.15 02U
(Alternative)	Zhejiang Meishuo Electric Technology Co., Ltd.	MPY-S-112-A	20A; 250VAC; 100000 cycles; T85°C	EN 61810-1 GB 3836.1 GB 3836.8 EN 60079-0 EN 60079-15	TUV R50204088 CNEx15.19 80U

## IEC 60335-2-40

(Alternative)	Dongguan Sanyou Electrical Appliances Co., Ltd	SFK-112DMP-E	25A 250VAC	EN 61810-1 GB 3836.1 GB 3836.8 EN 60079-0 EN 60079-15	VDE: 40007481 CNEx20.34 89U
Outdoor relay for G, H, G1, H1	Dongguan Sanyou Electrical Appliances Co., Ltd	SMIH-SH-112LM	17A; 277VAC; 100000 cycle; T85°C	EN 61810-1 GB 3836.1 GB 3836.8 EN 60079-0 EN 60079-15	VDE 40034054 CNEx15.151 3U CNEx15.152 0U
(Alternative)	Tyco Electronics (Shenzhen) Co., Ltd.	OMIH-SH-112LM	16A; 250VAC; 100000 cycle; T85°C	EN 61810-1 GB 3836.1 GB 3836.8 EN 60079-0 EN 60079-15	TUV R50139138 CNEx15.111 3U
(Alternative)	Dongguan Churod Electronics Co., Ltd.	CHZ02-S-112LA2	16A; 250VAC; 100000 cycle; T85°C	EN 61810-1 GB 3836.1 GB 3836.8 EN 60079-0 EN 60079-15	TUV R50212872 CNEx15.048 5U
(Alternative)	Zhejiang Meishuo Electric Technology Co., Ltd.	MPJ-S-112-A-2	16A; 250VAC; 100000 cycle; T85°C	EN 61810-1 GB 3836.1 GB 3836.8 EN 60079-0 EN 60079-15	CNEx15.37 75U TÜV Rh R50294981
(Alternative)	Wangrong Electronics (Shenzhen) Co., Ltd.	RMIH-SS-112LM-S	16A; 250VAC; 100000 cycle; T85°C	EN 61810-1 GB 3836.1 GB 3836.8 EN 60079-0 EN 60079-15	TUV: R50242245 CNEx15.144 0U
(Alternative)	Tyco Electronics (Shenzhen) Co., Ltd.	PCJ-112D3MH-WG	5A; 250VAC; 100000 cycle; T85°C	EN 61810-1 GB 3836.1 GB 3836.8 EN 60079-0 EN 60079-15	VDE 40009151 CNEx16.30 73U
(Alternative)	Wangrong Electronics (Shenzhen) Co., Ltd.	RC-112DM1H	5A 250VAC; 100000 cycle; T85°C	EN 61810-1 EN 60079-0 EN 60079-15	VDE 40034781
(Alternative)	Dongguan Sanyou Electrical Appliances Co., Ltd	SRB-SH-112DM2	5A; 277VAC; 100000 cycle; T85°C	EN 61810-1 GB 3836.1 GB 3836.8 EN 60079-0 EN 60079-15	VDE 40033402 CNEx15.150 9U CNEx15.152 3U
(Alternative)	Zhejiang Meishuo Electric Technology Co., Ltd.	MPR-S-112-A	5A; 250VAC; 100000 cycle; T85°C	EN 61810-1 GB 3836.1 GB 3836.8 EN 60079-0 EN 60079-15	CNEx15.198 3U TUV Rh R50217035
(Alternative)	Dongguan Churod Electronics Co., Ltd.	CHM-S-112DA3	5A; 250VAC; operation cycles: 100000cycle; T85°C	EN 61810-1 GB 3836.1 GB 3836.8 EN 60079-0 EN 60079-15	TUV: R50196152 CNEx15.048 8U

## IEC 60335-2-40

Indoor bridge rectifier for A, A1, B, B1, C, C1, D, D1, E, E1, F, F1	Yangzhou Yangjie Electronic Technology Co., Ltd.	GBU410A	1000V;4A	EN 60335-2-40 EN 60335-1	Test with appliance
(Alternative)	Jiangsu Dongchen Electronics Technology Co., Ltd.	GBU410	1000V;4A	EN 60335-2-40 EN 60335-1	Test with appliance
(Alternative)	Huixin Electronics Technology Co., Ltd.	GBU410	1000V;4A	EN 60335-2-40 EN 60335-1	Test with appliance
(Alternative)	Leshan Radio Company, Ltd.	GBU4K	1000V;4A	EN 60335-2-40 EN 60335-1	Test with appliance
(Alternative)	Microsemi Shanghai Co., Ltd.	GBU410	1000V;4A	EN 60335-2-40 EN 60335-1	Test with appliance
(Alternative)	Leshan Share Electronic Co., Ltd.	GBU410	1000V;4A	EN 60335-2-40 EN 60335-1	Test with appliance
(Alternative)	Lite-On Semiconductor Corp.	GBU410	1000V;4A	EN 60335-2-40 EN 60335-1	Test with appliance
(Alternative)	Taiwan Semiconductor	GBU407	1000V;4A	EN 60335-2-40 EN 60335-1	Test with appliance
(Alternative)	Panjit International Inc.	GBU4M	1000V;4A	EN 60335-2-40 EN 60335-1	Test with appliance
(Alternative)	Suzhou Good-Ark Electronics Co., Ltd.	GBU410	1000V;4A	EN 60335-2-40 EN 60335-1	Test with appliance
Outdoor bridge rectifier for A, A1, B, B1, C, C1, F, F1	Yangzhou Yangjie Electronic Technology Co., Ltd.	GBJ2510	1000V;25A	EN 60335-2-40 EN 60335-1	Test with appliance
(Alternative)	Jiangsu Dongchen Electronics Technology Co., Ltd.	GBJ2510	1000V;25A	EN 60335-2-40 EN 60335-1	Test with appliance
(Alternative)	Huixin Electronics Technology Co., Ltd.	GBJ2510	1000V;25A	EN 60335-2-40 EN 60335-1	Test with appliance
(Alternative)	Microsemi Shanghai Co., Ltd.	GBJ25J	1000V;25A	EN 60335-2-40 EN 60335-1	Test with appliance
(Alternative)	Shindengen Electric Mfg. Co., Ltd.	D25X100	1000V;25A	EN 60335-2-40 EN 60335-1	Test with appliance
(Alternative)	Leshan Share Electronic Co., Ltd.	D25SB100	1000V;25A	EN 60335-2-40 EN 60335-1	Test with appliance
(Alternative)	Lite-On Semiconductor Corp.	GBJ2510-F or GBJ2510	1000V;25A	EN 60335-2-40 EN 60335-1	Test with appliance
(Alternative)	Leshan Radio Company, Ltd.	D25SB100	1000V;25A	EN 60335-2-40 EN 60335-1	Test with appliance
(Alternative)	Panjit International Inc.	KBJ2510	1000V;25A	EN 60335-2-40 EN 60335-1	Test with appliance
(Alternative)	Suzhou Good-Ark Electronics Co., Ltd.	GBJ25M	1000V;25A	EN 60335-2-40 EN 60335-1	Test with appliance
(Alternative)	Taiwan Semiconductor	TS25P07G	1000V; 25A	EN 60335-2-40 EN 60335-1	Test with appliance
Outdoor bridge rectifier for D, D1, E, E1	Yangzhou Yangjie Electronic Technology Co., Ltd.	GBJ3510	1000V;35A	EN 60335-2-40 EN 60335-1	Test with appliance

## IEC 60335-2-40

(Alternative)	Jiangsu Dongchen Electronics Technology Co., Ltd.	GBJ3510	1000V;35A	EN 60335-2-40 EN 60335-1	Test with appliance
(Alternative)	Huixin Electronics Technology Co., Ltd.	GBJ3510	1000V;35A	EN 60335-2-40 EN 60335-1	Test with appliance
(Alternative)	Leshan Share Electronic Co., Ltd.	D35SB100A	1000V;35A	EN 60335-2-40 EN 60335-1	Test with appliance
(Alternative)	Microsemi Shanghai Co., Ltd.	GBJ35M	1000V;35A	EN 60335-2-40 EN 60335-1	Test with appliance
(Alternative)	Lite-On Semiconductor Corp.	GBJ3510	1000V;35A	EN 60335-2-40 EN 60335-1	Test with appliance
(Alternative)	Taiwan Semiconductor	TS35P07G	1000V;35A	EN 60335-2-40 EN 60335-1	Test with appliance
(Alternative)	Panjit International Inc.	KBJ3510	1000V;35A	EN 60335-2-40 EN 60335-1	Test with appliance
(Alternative)	Suzhou Good-Ark Electronics Co., Ltd.	GBJ35M	1200V;35A	EN 60335-2-40 EN 60335-1	Test with appliance
Outdoor bridge rectifier for G, H, G1, H1	Shindengen Electric Mfg. Co., Ltd.	D25X100	1000V;25A	EN 60335-2-40 EN 60335-1	Test with appliance
(Alternative)	Suzhou Good-Ark Electronics Co., Ltd.	GBJ25M	1000V;25A	EN 60335-2-40 EN 60335-1	Test with appliance
(Alternative)	Lite-On Semiconductor Corp.	GBJ2510-F or GBJ2510	1000V;25A	EN 60335-2-40 EN 60335-1	Test with appliance
(Alternative)	Leshan Share Electronic Co., Ltd.	D25SB100	1000V;25A	EN 60335-2-40 EN 60335-1	Test with appliance
(Alternative)	Panjit International Inc.	KBJ2510	1000V;25A	EN 60335-2-40 EN 60335-1	Test with appliance
(Alternative)	Microsemi Shanghai Co., Ltd.	GBJ25J	1000V;25A	EN 60335-2-40 EN 60335-1	Test with appliance
(Alternative)	Huixin Electronics Technology Co., Ltd.	GBJ2510	1000V;25A	EN 60335-2-40 EN 60335-1	Test with appliance
(Alternative)	Taiwan Semiconductor	TS25P07G	1000V; 25A	EN 60335-2-40 EN 60335-1	Test with appliance
(Alternative)	Yangzhou Yangjie Electronic Technology Co., Ltd.	GBJ2510	1000V;25A	EN 60335-2-40 EN 60335-1	Test with appliance
(Alternative)	Jiangsu Dongchen Electronics Technology Co., Ltd.	GBJ2510	1000V;25A	EN 60335-2-40 EN 60335-1	Test with appliance
(Alternative)	Leshan Radio Company, Ltd.	D25SB100	1000V;25A	EN 60335-2-40 EN 60335-1	Test with appliance
Surge absorber for A, A1, B, B1, C, C1, D, D1, E, E1, F, F1	Tyco Electronics (Shenzhen) Co., Ltd.	GRA-362-D7(N)	3600V	EN 60335-2-40 EN 60335-1	Test with appliance
(Alternative)	Okaya Electric America	RA-362MS-V7(RA)	3600V	EN 60335-2-40 EN 60335-1	Test with appliance
(Alternative)	Epcos Ag	EM3600X6S	3600V	EN 60335-2-40 EN 60335-1	Test with appliance
(Alternative)	Acpa Technology Co., Ltd.	ACPA2R3600	3600V	EN 60335-2-40 EN 60335-1	Test with appliance

## IEC 60335-2-40

(Alternative)	Mitsubishi Electric	DA38-362M	3600V	EN 60335-2-40 EN 60335-1	Test with appliance
(Alternative)	Brightking (Shenzhen) Co., Ltd. China	2RK3600L-5	3600V	EN 60335-2-40 EN 60335-1	Test with appliance
(Alternative)	Bencent	B5G3600-6	3600V	EN 60335-2-40 EN 60335-1	Test with appliance
Surge absorber for G, H, G1, H1	Mitsubishi Electric	DA38-362M	3600V	EN 60335-2-40 EN 60335-1	Test with appliance
(Alternative)	Acpa Technology Co., Ltd.	ACPA2R3600	3600V	EN 60335-2-40 EN 60335-1	Test with appliance
(Alternative)	Brightking (Shenzhen) Co., Ltd. China	2RK3600L-5	3600V	EN 60335-2-40 EN 60335-1	Test with appliance
(Alternative)	Okaya Electric America	RA-362MS-V7(RA)	3600V	EN 60335-2-40 EN 60335-1	Test with appliance
(Alternative)	Epcos Ag	EM3600X6S	3600V	EN 60335-2-40 EN 60335-1	Test with appliance
(Alternative)	Shenzhen Bencent Electronics Co., Ltd.	B5G3600-6	3100-4200V	EN 60335-2-40 EN 60335-1	Test with appliance
(Alternative)	Tyco Electronics (Shenzhen) Co., Ltd.	GRA-362-D7(N)	3600V	EN 60335-2-40 EN 60335-1	Test with appliance
Indoor optocoupler for A, A1, B, B1, C, C1, D, D1, F, F1, G, H, G1, H1	Everlight Electronics., Ltd.	EL851	IF:80 mA; IFM:1A; VR: 6V; VCEO:350V; VECO:7V; IC:100mA	EN 60335-2-40 EN 60335-1	Test with appliance
(Alternative)	Sharp Corp Electronic Components Group	PC851	IF:50 mA; IFM:1A; VR: 6V; VCEO:350V; VECO:6V; IC:50mA	EN 60335-2-40 EN 60335-1	Test with appliance
(Alternative)	Toshiba Semiconductor Company	P628	IF:50 mA; IFM:1A; VR: 6V; VCEO:350V; VECO:6V; IC:50mA	EN 60335-2-40 EN 60335-1	Test with appliance
(Alternative)	Lite-On Electronics, Inc.	851MD	IF:60mA; VR: 6V; VCEO:350V; VECO:6V; IC:50mA	EN 60335-2-40 EN 60335-1	Test with appliance
(Alternative)	Wuxi China Resources Semico Co., Ltd.	HK851Y	IF:50 mA; VR: 6V; VCEO:350V; VECO:7V; IC:50mA	EN 60335-2-40 EN 60335-1	Test with appliance
(Alternative)	Everlight Electronics., Ltd.	EL816	IF:60mA; IFM:1A; VR: 6V; VCEO:80V; VECO:6V; IC:50mA	EN 60335-2-40 EN 60335-1	Test with appliance
(Alternative)	Lite-On Electronics, Inc.	816 B	IF:50mA; VR: 6V; VCEO:80V; VECO:6V; IC:50mA	EN 60335-2-40 EN 60335-1	Test with appliance

## IEC 60335-2-40

(Alternative)	Toshiba Semiconductor Company	P785	IF:60mA; VR: 5V; VCEO:80V; VECO:7V; IC:50mA	EN 60335-2-40 EN 60335-1	Test with appliance
(Alternative)	Sharp Corp Electronic Components Group	PC817	IF:50 mA; IFM:1A; VR: 6V; VCEO:80V; VECO:6V; IC:50mA	EN 60335-2-40 EN 60335-1	Test with appliance
(Alternative)	Wuxi China Resources Semico Co., Ltd.	HK817B	IF:50 mA; VR: 6V; VCEO:80V; VECO:6V; IC:50mA	EN 60335-2-40 EN 60335-1	Test with appliance
Indoor optocoupler for E, E1	Everlight Electronics., Ltd.	EL816	IF:60 mA; IFM:1A; VR: 6V; VCEO:80V; VECO:6V; IC:50mA	EN 60335-2-40 EN 60335-1	Test with appliance
(Alternative)	Lite-On Electronics, Inc.	816 B	IF:50 mA; VR: 6V; VCEO:80V; VECO:6V; IC:50mA	EN 60335-2-40 EN 60335-1	Test with appliance
(Alternative)	Sharp Corp Electronic Components Group	PC817	IF:50 mA; IFM:1A; VR: 6V; VCEO:80V; VECO:6V; IC:50mA	EN 60335-2-40 EN 60335-1	Test with appliance
(Alternative)	Wuxi China Resources Semico Co., Ltd.	HK817B	IF:50 mA; VR: 6V; VCEO:80V; VECO:6V; IC:50mA	EN 60335-2-40 EN 60335-1	Test with appliance
(Alternative)	Everlight Electronics., Ltd.	EL851	IF:60 mA; IFM:1A; VR: 6V; VCEO:350V; VECO:7V; IC:50mA	EN 60335-2-40 EN 60335-1	Test with appliance
(Alternative)	Toshiba Semiconductor Company	P628	IF:60 mA; IFP:1A; VR: 5V; VCEO:350V; VECO:7V; IC:50mA	EN 60335-2-40 EN 60335-1	Test with appliance
(Alternative)	Sharp Corp Electronic Components Group	PC851	IF:50 mA; IFM:1A; VR: 6V; VCEO:350V; VECO:6V; IC:50mA	EN 60335-2-40 EN 60335-1	Test with appliance
(Alternative)	Lite-On Electronics, Inc.	851MD or 851	IF:60 mA; VR: 6V; VCEO:350V; VECO:6V; IC:50mA	EN 60335-2-40 EN 60335-1	Test with appliance
(Alternative)	Wuxi China Resources Semico Co., Ltd.	HK851Y	IF:50 mA; VR: 6V; VCEO:350V; VECO:7V; IC:50mA	EN 60335-2-40 EN 60335-1	Test with appliance

## IEC 60335-2-40

Outdoor optocoupler for A, A1, B, B1, C, C1, D, D1, E, E1, F, F1	Everlight Electronics., Ltd.	EL816	IF:60 mA; IFM:1A; VR: 6V; VCEO:80V; VECO:6V; IC:50mA	EN 60335-2-40 EN 60335-1	Test with appliance
(Alternative)	Lite-On Electronics, Inc.	816 B	IF:50 mA; VR: 6V; VCEO:80V; VECO:6V; IC:50mA	EN 60335-2-40 EN 60335-1	Test with appliance
(Alternative)	Sharp Corp Electronic Components Group	PC817	IF:50 mA; IFM:1A; VR: 6V; VCEO:80V; VECO:6V; IC:50mA	EN 60335-2-40 EN 60335-1	Test with appliance
(Alternative)	Wuxi China Resources Semico Co., Ltd.	HK817B	IF:50 mA; VR: 6V; VCEO:80V; VECO:6V; IC:50mA	EN 60335-2-40 EN 60335-1	Test with appliance
(Alternative)	Everlight Electronics., Ltd.	EL851	IF:60 mA; IFM:1A; VR: 6V; VCEO:350V; VECO:7V; IC:50mA	EN 60335-2-40 EN 60335-1	Test with appliance
(Alternative)	Toshiba Semiconductor Company	P628	IF:60 mA; IFP:1A; VR: 5V; VCEO:350V; VECO:7V; IC:50mA	EN 60335-2-40 EN 60335-1	Test with appliance
(Alternative)	Sharp Corp Electronic Components Group	PC851	IF:50 mA; IFM:1A; VR: 6V; VCEO:350V; VECO:6V; IC:50mA	EN 60335-2-40 EN 60335-1	Test with appliance
(Alternative)	Lite-On Electronics, Inc.	851MD or 851	IF:60 mA; VR: 6V; VCEO:350V; VECO:6V; IC:50mA	EN 60335-2-40 EN 60335-1	Test with appliance
(Alternative)	Wuxi China Resources Semico Co., Ltd.	HK851Y	IF:50 mA; VR: 6V; VCEO:350V; VECO:7V; IC:50mA	EN 60335-2-40 EN 60335-1	Test with appliance
Outdoor optocoupler for G, H, G1, H1	Everlight Electronics., Ltd.	EL816	IF:60 mA; IFM:1A; VR: 6V; VCEO:80V; VECO:6V; IC:50mA	EN 60335-2-40 EN 60335-1	Test with appliance
(Alternative)	Lite-On Electronics, Inc.	816 B	IF:50 mA; VR: 6V; VCEO:80V; VECO:6V; IC:50mA	EN 60335-2-40 EN 60335-1	Test with appliance
(Alternative)	Sharp Corp Electronic Components Group	PC817	IF:50 mA; IFM:1A; VR: 6V; VCEO:80V; VECO:6V; IC:50mA	EN 60335-2-40 EN 60335-1	Test with appliance
(Alternative)	Wuxi China Resources Semico Co., Ltd.	HK817B	IF:50 mA; VR: 6V; VCEO:80V; VECO:6V; IC:50mA	EN 60335-2-40 EN 60335-1	Test with appliance

## IEC 60335-2-40

(Alternative)	Everlight Electronics., Ltd.	EL851	IF:60 mA; IFM:1A; VR: 6V; VCEO: 350V; VECO:7V; IC:50mA	EN 60335-2-40 EN 60335-1	Test with appliance
(Alternative)	Lite-On Electronics, Inc.	851MD or 851	IF:60 mA; VR: 6V; VCEO:350V; VECO: 6V; IC: 50mA	EN 60335-2-40 EN 60335-1	Test with appliance
(Alternative)	Wuxi China Resources Semico Co., Ltd.	HK851Y	IF:50 mA; VR: 6V; VCEO:350V; VECO:7V; IC:50mA	EN 60335-2-40 EN 60335-1	Test with appliance
(Alternative)	Toshiba Semiconductor Company	P628	IF:60 mA; IFP:1A; VR: 5V; VCEO: 350V; VECO:7V; IC:50mA	EN 60335-2-40 EN 60335-1	Test with appliance
(Alternative)	Sharp Corp Electronic Components Group	PC851	IF:50 mA; IFM:1A; VR: 6V; VCEO: 350V; VECO:6V; IC:50mA	EN 60335-2-40 EN 60335-1	Test with appliance
IPM for A, A1, B, B1, C, C1, F, F1	Fuji Electric	6MBP15XSF06 0-5	15A; 600V	EN 60335-2-40 EN 60335-1	Test with appliance
(Alternative)	Mitsubishi Electric	PSS15S92F6-AG	15A; 600V	EN 60335-2-40 EN 60335-1	Test with appliance
(Alternative)	Mitsubishi Electric	PSS15S92E6-AG	15A; 600V	EN 60335-2-40 EN 60335-1	Test with appliance
(Alternative)	Toshiba	TPD4204F		EN 60335-2-40 EN 60335-1	Test with appliance
(Alternative)	Hangzhou Silan Microelectronics Co., Ltd.	SDM15G60FB	600V; 15A	EN 60335-2-40 EN 60335-1	Test with appliance
IPM for D, D1	Fuji Electric	6MBP20XSF06 0-50	20A; 600V	EN 60335-2-40 EN 60335-1	Test with appliance
(Alternative)	Toshiba	TPD4204F/PIN 30-FAN	2,5A; 600V	EN 60335-2-40 EN 60335-1	Test with appliance
IPM for G, H, G1, H1	MITSUBISHI ELECTRIC	PSS15S92F6-AG	15A; 600V	EN 60335-2-40 EN 60335-1	Test with appliance
(Alternative)	Toshiba	TPD4204F	2,5A; 600V	EN 60335-2-40 EN 60335-1	Test with appliance
IPM for E, E1	Sanken Electric Co., Ltd.	SIM6822M	5A; 600V	EN 60335-2-40 EN 60335-1	Test with appliance
(Alternative)	Sanken Electric Co., Ltd.	SIM6822MV	5A; 600V	EN 60335-2-40 EN 60335-1	Test with appliance
(Alternative)	Fuji Electric	6MBP30XSF06 0-50	30A; 600V	EN 60335-2-40 EN 60335-1	Test with appliance
Indoor terminal block for A, A1, B, B1, C, C1, D, D1, E, E1, F, F1, G, H, G1, H1	Nantong Huaguan Electric Co., Ltd.	JXW-5-R	600V 4mm <sup>2</sup>	EN 60335-2-40 EN 60335-1	Test with appliance
(Alternative)	Changzhou Kaidu Electrical Co., Ltd.	JXG-5E	450VAC; 4mm <sup>2</sup>	EN 60335-2-40 EN 60335-1	Test with appliance

## IEC 60335-2-40

(Alternative)	Foshan Shunde Yuanfeng Metal Electricrical Appliances Co., Ltd.	YF2001C	450VAC; 4mm <sup>2</sup>	EN 60335-2-40 EN 60335-1	Test with appliance
(Alternative)	Wenzhou Lizijia Electric Co., Ltd.	JXZ-2205E	450V~ 4mm <sup>2</sup>	EN 60335-2-40 EN 60335-1	Test with appliance
Outdoor terminal block for A, A1, B, B1, C, C1, D, D1, E, E1, F, F1, G, H, G1, H1	Changzhou Kaidu Electrical Co., Ltd.	JX-B6	450V 4mm <sup>2</sup>	EN 60335-2-40 EN 60335-1	Test with appliance
(Alternative)	Foshan Shunde Yuanfeng Metal Electricrical Appliances Co., Ltd.	YF2004A	660V 4mm <sup>2</sup>	EN 60335-2-40 EN 60335-1	Test with appliance
(Alternative)	Wenzhou Lizijia Electric Co., Ltd.	JXZ-1206A	660V~ 4mm <sup>2</sup>	EN 60335-2-40 EN 60335-1	Test with appliance
Indoor electrolytic capacitor for A, A1, B, B1, C, C1, D, D1, E, E1, F, F1, G, H, G1, H1	Shenzhen Jianghao Electronics Co., Ltd.	CD289A	450VDC; 82μF VENT 105°C	EN 60335-2-40 EN 60335-1	Test with appliance
(Alternative)	Epcos (Xiamen) Co., Ltd.	B3252-S5826-M1	450V, 82μF VENT 105°C	EN 60335-2-40 EN 60335-1	Test with appliance
(Alternative)	Nichicon Corporation Co., Ltd.	GG(M)	400VAC or 450VAC; 82μF; VENT 105°C	EN 60335-2-40 EN 60335-1	Test with appliance
(Alternative)	Hunan Aihua Group Co., Ltd.	LH (E-82uM450)	450V, 82μF 105°C	EN 60335-2-40 EN 60335-1	Test with appliance
(Alternative)	Capxon Electronic (Shen-Zhen) Co., Ltd.	UJ	82μF 450V 105°C	EN 60335-2-40 EN 60335-1	Test with appliance
(Alternative)	Samxon Electronics (Dongguan) Co., Ltd.	HP	82μF 450V 105°C	EN 60335-2-40 EN 60335-1	Test with appliance
Outdoor electrolytic capacitor for A, A1, B, B1, C, C1, F, F1	Shenzhen Jianghao Electronics Co., Ltd.	CD291A	450VDC; 470μF VENT 105°C	EN 60335-2-40 EN 60335-1	Test with appliance
(Alternative)	Hunan Aihua Group Co., Ltd.	LH	450V, 470μF 105°C	EN 60335-2-40 EN 60335-1	Test with appliance
(Alternative)	Nichicon Corporation Co., Ltd.	GG(M)	400VAC or 450VAC; 470μF; VENT 105°C	EN 60335-2-40 EN 60335-1	Test with appliance
(Alternative)	Samxon Electronics (Dongguan) Co., Ltd.	HP(M)	450VAC; 470μF; VENT 105°C	EN 60335-2-40 EN 60335-1	Test with appliance
(Alternative)	Epcos (Xiamen) Co., Ltd.	B43252-S5477-M7(B43252S5477M007)	450V, 470μF VENT 105°C	EN 60335-2-40 EN 60335-1	Test with appliance

## IEC 60335-2-40

(Alternative)	Capxon Electronic (Shen-Zhen) Co., Ltd.	UJ471M450P45 0A00A or UJ	470µF-450v UJ VENT 105°C	EN 60335-2-40 EN 60335-1	Test with appliance
Outdoor electrolytic capacitor for D, D1	Shenzhen Jianghao Electronics Co., Ltd.	CD291A	450VDC; 680µF VENT 105°C	EN 60335-2-40 EN 60335-1	Test with appliance
(Alternative)	Nippon Chemi-Con Corporation	KMQ	450V, 680µF 105°C	EN 60335-2-40 EN 60335-1	Test with appliance
(Alternative)	Hunan Aihua Group Co., Ltd.	LH	450V, 680µF 105°C	EN 60335-2-40 EN 60335-1	Test with appliance
(Alternative)	Nichicon Corporation Co., Ltd.	GG(M)	400VAC or 450VAC; 680µF; VENT 105°C	EN 60335-2-40 EN 60335-1	Test with appliance
(Alternative)	Samxon Electronics (Dongguan) Co., Ltd.	HP(M)	450VAC; 680µF; VENT 105°C	EN 60335-2-40 EN 60335-1	Test with appliance
(Alternative)	Capxon Electronic (Shen-Zhen) Co., Ltd.	UJ681M450P50 0A000ADI or UJ	680µF-450v UJ VENT 105°C	EN 60335-2-40 EN 60335-1	Test with appliance
Outdoor electrolytic capacitor for E, E1	Shenzhen Jianghao Electronics Co., Ltd.	CD289A	450VDC 820µF VENT 105°C	EN 60335-2-40 EN 60335-1	Test with appliance
(Alternative)	Epcos (Xiamen) Co., Ltd.	B43641-S5827-M1	450V, 820µF VENT 105°C	EN 60335-2-40 EN 60335-1	Test with appliance
(Alternative)	Nippon Chemi-Con Corporation	KMW	450V, 820µF 105°C	EN 60335-2-40 EN 60335-1	Test with appliance
(Alternative)	Hunan Aihua Group Co., Ltd.	LH	450V, 820µF 105°C	EN 60335-2-40 EN 60335-1	Test with appliance
(Alternative)	Shenzhen Jianghao Electronics Co., Ltd.	CD291A	450VDC; 820µF; VENT 105°C	EN 60335-2-40 EN 60335-1	Test with appliance
(Alternative)	Samxon Electronics (Dongguan) Co., Ltd.	HP(M)	450VAC; 820µF; VENT 105°C	EN 60335-2-40 EN 60335-1	Test with appliance
Outdoor electrolytic capacitor for G, H, G1, H1	Capxon Electronic (Shen-Zhen) Co., Ltd.	UJ471M450P45 0A00A	CapXON 470µF- 450v UJ VENT 105°C	EN 60335-2-40 EN 60335-1	Test with appliance
(Alternative)	Shenzhen Jianghao Electronics Co., Ltd.	CD291A	450VDC; 470µF VENT 105°C	EN 60335-2-40 EN 60335-1	Test with appliance
(Alternative)	Epcos (Xiamen) Co., Ltd.	B43252-S5477-M7	450V, 470µF VENT 105°C	EN 60335-2-40 EN 60335-1	Test with appliance
(Alternative)	Samxon Electronics (Dongguan) Co., Limited	HP(M)	450VAC; 470µF; VENT 105°C	EN 60335-2-40 EN 60335-1	Test with appliance
(Alternative)	Nichicon Corporation Co., Ltd.	GG(M) 470µF 450V CE 105°C	400VAC or 450VAC; 470µF; VENT 105°C	EN 60335-2-40 EN 60335-1	Test with appliance
(Alternative)	Hunan Aihua Group Co., Ltd.	LH	450V, 470µF 105°C	EN 60335-2-40 EN 60335-1	Test with appliance
Indoor varistor for A, A1, B, B1, C, C1, D, D1, E, E1, F, F1, G, H, G1, H1	Guangxi New Future Information Industry Co., Ltd.	NFC14D681KM / NFC14D681K	680V; 50A; T85°C	EN 61051-1 EN 61051-2 EN 61051-2-2	VDE 40030322

## IEC 60335-2-40

(Alternative)	Shenzhen Chenju Electric Technology Co., Ltd	CNJU 14D681K-M / CNJU 14D681K/ CNJU 14D681KM	680V; 50A; T85°C	EN 61051-1 EN 61051-2 EN 61051-2-2	VDE 40034186
(Alternative)	Nanjing Shagon Electronics Co., Ltd.	MYG14K681N / MYG14K681	680V, T85°C, 4,5KA*1	EN 61051-1 EN 61051-2 EN 61051-2-2	TUV: Z116067971 2002
(Alternative)	Chengdu Tieda Electronic Co., Ltd.	MYN15- 681K/MYN15- 681K	680V; 50A; T125°C	EN 61051-1 EN 61051-2 EN 61051-2-2	VDE 40008571
(Alternative)	Guangdong Welkin Thinking Electronic Co., Ltd.	TVR14681 /TVR14681	Φ14; 680V, T85°C	EN 61051-1 EN 61051-2 EN 61051-2-2	VDE 005944
(Alternative)	Nanjing Shagon Electronics Co., Ltd.	MYG14K681N/ MYG14K681	680V T85°C	EN 61051-1 EN 61051-2 EN 61051-2-2	TUV SUD Z118017971 2003
(Alternative)	Success Electronics (Huizhou) Co., Ltd	SVR14D681K	680V T85°C	EN 61051-1 EN 61051-2 EN 61051-2-2	VDE 123677
Outdoor varistor for A, A1, B, B1, C, C1, D, D1, E, E1, F, F1	Guangxi New Future Information Industry Co., Ltd.	NFC14D621K /NFC14D621K	620V;50A; T85°C	EN 61051-1 EN 61051-2 EN 61051-2-2	VDE 40030322
(Alternative)	Shenzhen Chenju Electric Technology Co., Ltd	14D621K	620V; 50A; T85°C	EN 61051-1 EN 61051-2 EN 61051-2-2	VDE: 40008220
(Alternative)	Pt. Panasonic Industrial Devices Batam	E11621	558V ~ 682V, 50A; T85°C	EN 61051-1 EN 61051-2 EN 61051-2-2	VDE 40035231
(Alternative)	Success Electronics Co., Ltd.	10D621KH /SVR10D621KX XXXH(VDE)	620V; In=3KA; T85°C	EN 61051-1 EN 61051-2 EN 61051-2-2	VDE 40030401
(Alternative)	Chengdu Tieda Electronic Co., Ltd.	MYN15- 621K/MYN15- 621K	620V; 50A; T125°C	EN 61051-1 EN 61051-2 EN 61051-2-2	VDE 40008571
(Alternative)	Guangdong Fenghua Advanced Technology (Holding) Co., Ltd.	FNR- 14K621/FNR- 14K621TBT	558V~682V T85°C	EN 61051-1 EN 61051-2 EN 61051-2-2	VDE 40008242
(Alternative)	Huizhou Songlong Lishang Electronics Co., Ltd.	VDR-14D621K	620V±10% T85°C	EN 61051-1 EN 61051-2 EN 61051-2-2	VDE 40028836
Outdoor varistor for G, H, G1, H1	Huizhou Songlong Lishang Electronics Co., Ltd.	VDR-14D621K	620V±10% T85°C	EN 61051-1 EN 61051-2 EN 61051-2-2	VDE 40028836
(Alternative)	Shenzhen Chenju Electric Technology Co., Ltd	14D621K	620V; 50A; T85°C	EN 61051-1 EN 61051-2 EN 61051-2-2	VDE 40008220
(Alternative)	Guangdong Fenghua Advanced Technology (Holding) Co., Ltd	FNR- 14K621/FNR- 14K621TBT	558V~682V T85°C	EN 61051-1 EN 61051-2 EN 61051-2-2	VDE 40008242

## IEC 60335-2-40

(Alternative)	Pt. Panasonic Industrial Devices Batam	E11621	558V ~ 682V, 50A; T85°C	EN 61051-1 EN 61051-2 EN 61051-2-2	VDE 40035231
(Alternative)	Success Electronics Co., Ltd.	10D621KH /SVR10D621KX XXXH	620V; In=3KA; T85°C	EN 61051-1 EN 61051-2 EN 61051-2-2	VDE 40030401
(Alternative)	Guangxi New Future Information Industry Co., Ltd.	NFC14D621K	620V; 50A; T85°C	EN 61051-1 EN 61051-2 EN 61051-2-2	VDE 40030322
(Alternative)	Chengdu Tieda Electronic Co., Ltd.	MYN15-621K/MYN15-621K	620V; 50A; T125°C	EN 61051-1 EN 61051-2 EN 61051-2-2	VDE 40008571
(Alternative)	Pt. Panasonic Industrial Devices Batam	E11621	558V ~ 682V, T85°C	EN 61051-1 EN 61051-2 EN 61051-2-2	VDE 40035231
Indoor X2 capacitor I for A, A1, B, B1, C, C1, D, D1, F, F1, G, H, G1, H1	Ultra Tech Xiphi Enterprise Co., Ltd.	HQX	X2, 275 Vac; 0,47µF,40/110/56/B	EN 60384-14	VDE 0024534
(Alternative)	Okaya Electric Industries Co., Ltd.	LE474-MX	AC310V; 50/60Hz; 0,47µF; T110°C	EN 60384-14	ENEC SE/0142-1
(Alternative)	Xiamen Faratronic Co., Ltd.	MKP62	X2; AC 275V; 0,47µF; K; 40/110/56; B	EN 60384-14	VDE: 0000358
(Alternative)	Foshan City Xin Yuan Electronic Co., Ltd.	MKP-X2	AC275V; 0,47µF; 40/100/21	EN 60384-14	VDE: 40027433
(Alternative)	Changzhou Jiaguan Electronics Co., Ltd.	MKP-X2	AC275/300V, 0,47µF, 40/110/21/C	EN 60384-14	VDE: 0037250
(Alternative)	Ultra Tech Xiphi Enterprise Co., Ltd.	HQX474K275N	275vac; 0,47µF	EN 60384-14	VDE 40024534
(Alternative)	Guangdong Fengming Electronic Tech. Co., Ltd.	MKP-X2	275VAC; 0,47µF M 40/110/56B	EN 60384-14	VDE 40025702
(Alternative)	Nistronics(Jiangxi) Co Ltd	MPRV0275K47 4M2V8H210	X2; 275VAC 0,47µF,40/100/21	EN 60384-14	VDE 40032056
(Alternative)	HUZHOU YILI ELECTRONICS CO., LTD	EE922AA3224K 169:	0.47µF±10%,275V	EN 60384-14	VDE 40050002
(Alternative)	Nistronics(Jiangxi) Co Ltd	MPRV0275K47 4M2V8H210	X2; 275VAC 0,47µF,40/100/21	EN 60384-14	VDE 40032056
(Alternative)	HUZHOU YILI ELECTRONICS CO., LTD	EE922AA3224K 169:	0,47µF±10%,275V, 40/100/21	EN 60384-14	VDE 40050002
(Alternative)	Dong Guan Ultra New Tech Electronics Co., Ltd  KUNSHAN UTX VALUE ENTERPRISE CO.,LTD	HQX474K275	275vac; 0,47µF,40/100/21	EN 60384-14	VDE 40024534

## IEC 60335-2-40

Indoor X2 capacitor II for A, A1, B, B1, C, C1, D, D1, F, F1, G, H, G1, H1	Ultra Tech Xiphi Enterprise Co., Ltd.	HQX	275 Vac; 0,22µF, 40/110/56/B	EN 60384-14	VDE 0024534
(Alternative)	Okaya Electric Industries Co., Ltd.	LE224-MX	AC310V; 50/60Hz; 0,22µF; T110°C	EN 60384-14	ENEC SE/0142-1
(Alternative)	Xiamen Faratronic Co., Ltd.	MKP62	X2; AC 275V; 0,22µF; K; 40/110/56; B	EN 60384-14	VDE: 0000358
(Alternative)	Foshan City Xin Yuan Electronic Co., Ltd.	MKP-X2	AC275V; 0,22µF; 40/100/21	EN 60384-14	VDE: 40027433
(Alternative)	Shanghai Xiangriya Electronic Co., Ltd. (Xry)	MPX/MKP X2	224K; 275VAC; T 85°C or above; X2	EN 60384-14	VDE 40001876
(Alternative)	Guangdong Fengming Electronic Tech. Co., Ltd.	MKP-X2	275VAC; 0,22µF K 40/110/56 B	EN 60384-14	VDE 40025702
(Alternative)	HUZHOU YILI ELECTRONICS CO., LTD	EE922AA3224K 169	0,22µF±10%,275V 40/100/21	EN 60384-14	VDE 40050002
Indoor X2 capacitor I for E, E1	Ultra Tech Xiphi Enterprise Co., Ltd.	HQX	X2,275 Vac; 0,1µF, 40/110/56/B	EN 60384-14	VDE 0024534
(Alternative)	Okaya Electric Industries Co., Ltd.	LE104-MX	AC310V; 50/60Hz; 0,1µF; T110°C	EN 60384-14	ENEC SE/0142-1
(Alternative)	Xiamen Faratronic Co., Ltd.	MKP62	X2; AC 275V; 0,10µF; K; 40/110/56; B	EN 60384-14	VDE: 0000358
(Alternative)	Foshan City Xin Yuan Electronic Co., Ltd.	MKP-X2	AC275V;0,1µF;40/100/21	EN 60384-14	VDE: 40027433
(Alternative)	Shanghai Xiangriya Electronic Co., Ltd. (Xry)	MPX/MKP X2	104K; 275VAC; T 85°C or above; X2	EN 60384-14	VDE 40001876
(Alternative)	Guangdong Fengming Electronic Tech. Co., Ltd.	MKP-X2	275VAC; 0,1µF K 40/110/56B	EN 60384-14	VDE 40025702
(Alternative)	Nistrionics(Jiangxi) Co Ltd	MPRV0275K10 4M000H210	X2; 275VAC 0,1µF,40/100/21	EN 60384-14	VDE 40032056
Indoor X2 capacitor II for E, E1	Ultra Tech Xiphi Enterprise Co., Ltd.	HQX	X2, 275 Vac; 0,033µF,40/110/56 /B	EN 60384-14	VDE 0024534
(Alternative)	Xiamen Faratronic Co., Ltd.	MKP62	X2; AC 275V; 0,033µF; M; 40/110/56; B	EN 60384-14	VDE: 0000358
(Alternative)	Foshan City Xin Yuan Electronic Co., Ltd.	MKP-X2	AC275V; 0,033µF; 40/100/21	EN 60384-14	VDE: 40027433
(Alternative)	Shanghai Xiangriya Electronic Co., Ltd. (Xry)	MPX/MKP X2	333M; 275VAC; T 85°C or above; X2	EN 60384-14	VDE 40001876
(Alternative)	Guangdong Fengming Electronic Tech. Co., Ltd.	MKP-X2	275VAC; 0,033µF K 40/110/56 B	EN 60384-14	VDE 40025702

## IEC 60335-2-40

(Alternative)	Nistronics(Jiangxi) Co Ltd	MPRV 0275K3330220 H210	X2; 275VAC 0,033μF,40/100/21	EN 60384-14	VDE 40032056
Outdoor X2 capacitor I for A, A1, B, B1, C, C1, D, D1, E, E1, F, F1	Ultra Tech Xiphi Enterprise Co., Ltd.	HQX	X2,310 Vac; 1,5μF, 40/110/56/B	EN 60384-14	VDE 0024534
(Alternative)	Xiamen Faratronic Co., Ltd.	MKP62	AC 275V; 1,5μF; M; 40/110/56; B	EN 60384-14	VDE: 0000358
(Alternative)	Foshan City Xin Yuan Electronic Co., Ltd.	MKP-X2	AC275V; 1,5μF; 40/100/21	EN 60384-14	VDE: 40027433
(Alternative)	Changzhou Jiaguan Electronics Co., Ltd.	MKP-X2	AC275/300V, 1,5μF, 40/110/21/C	EN 60384-14	VDE: 0037250
(Alternative)	Shanghai Xiangriya Electronic Co., Ltd. (Xry)	MPX/MKP X2	155M; 275VAC; T 85°C or above; X2	EN 60384-14	VDE 40001876
(Alternative)	Guangdong Fengming Electronic Tech. Co., Ltd.	MKP-X2	275VAC; 1,5μF M 40/110/56B	EN 60384-14	VDE 40025702
(Alternative)	Nistronics (Jiangxi) Co., Ltd.	MPRC 0275K155C000 0037	X2; 275VAC; 1,5μF, 40/100/21	EN 60384-14	VDE 40032056
(Alternative)	Changzhou Jiaguan Electronics Co., Ltd.	MKPX2-275/300VAC-155K P22.5	275/300V; 155K 110	EN 60384-14	VDE: 40037250
Outdoor X2 capacitor II for A, A1, B, B1, C, C1, D, D1, E, E1, F, F1	Ultra Tech Xiphi Enterprise Co., Ltd.	HQX	275 VAC; 0,47μF, 40/110/56/B	EN 60384-14	VDE 40024534
(Alternative)	Okaya Electric Industries Co., Ltd.	LE474-MX	AC310V; 50/60Hz; 0,47μF; T110°C	EN 60384-14	ENEC SE/0142-1
(Alternative)	Xiamen Faratronic Co., Ltd.	MKP62	X2; AC 275V; 0,47μF; 40/110/56; B	EN 60384-14	VDE: 0000358
(Alternative)	Foshan City Xin Yuan Electronic Co., Ltd.	MKP-X2	AC275V; 0,47μF; 40/100/21	EN 60384-14	VDE: 40027433
(Alternative)	Changzhou Jiaguan Electronics Co., Ltd.	MKP-X2	AC275/300V, 0,47μF, 40/110/21/C	EN 60384-14	VDE: 0037250
(Alternative)	Shanghai Xiangriya Electronic Co., Ltd. (Xry)	MPX/MKP X2	474M; 275VAC; T 85°C or above; X2	EN 60384-14	VDE 40001876
(Alternative)	Guangdong Fengming Electronic Tech. Co., Ltd.	MKP-X2	275VAC; 0,47μF M 40/110/56B	EN 60384-14	VDE 40025702
(Alternative)	Nistronics(Jiangxi) Co., Ltd.	MPRV0275K47 4M2V8H210	X2 275VAC 0,47μF, 40/100/21	EN 60384-14	VDE 40032056
(Alternative)	Huzhou Yili Electronics Co., Ltd	EE922AA3224K 169	0,47μF±10%, 275V, 40/100/21	EN 60384-14	VDE 40050002
(Alternative)	Nistronics(Jiangxi) Co., Ltd.	MPRV0275K47 4M2V8H210	X2 275VAC 0,47μF, 40/100/21	EN 60384-14	VDE 40032056
(Alternative)	Huzhou Yili Electronics Co., Ltd	EE922AA3224K 169:	0,47μF±10%, 275V, 40/100/21	EN 60384-14	VDE 40050002

## IEC 60335-2-40

(Alternative)	Dong Guan Ultra New Tech Electronics Co., Ltd. Kunshan Utx Value Enterprise Co., Ltd	HQX474K275	275VAC, 0,47 $\mu$ F, 40/100/21	EN 60384-14	VDE 40024534
Outdoor X2 capacitor III for A, A1, B, B1, C, C1, D, D1, E, E1, F, F1	Ultra Tech Xiphi Enterprise Co., Ltd.	HQX	275 VAC; 0,033 $\mu$ F, 40/110/56/B	EN 60384-14	VDE 0024534
(Alternative)	Xiamen Faratronic Co., Ltd.	MKP62	X2; AC 275V; 0,033 $\mu$ F; M; 40/110/56; B	EN 60384-14	VDE: 0000358
(Alternative)	Foshan City Xin Yuan Electronic Co., Ltd.	MKP-X2	AC275V; 0,033 $\mu$ F; 40/100/21	EN 60384-14	VDE: 40027433
(Alternative)	Shanghai Xiangriya Electronic Co., Ltd. (Xry)	MPX/MKP X2	333M; 275VAC; T 85°C or above; X2	EN 60384-14	VDE 40001876
(Alternative)	Guangdong Fengming Electronic Tech. Co., Ltd.	MKP-X2	275VAC; 0,033 $\mu$ F K 40/110/56 B	EN 60384-14	VDE 40025702
(Alternative)	Nistronics (Jiangxi) Co., Ltd.	MPRV 0275K3330220 H210	X2 275VAC 0,033 $\mu$ F, 40/100/21	EN 60384-14	VDE 40032056
Outdoor X2 capacitor IV for A, A1, B, B1, C, C1, D, D1, E, E1, F, F1	Ultra Tech Xiphi Enterprise Co., Ltd.	HQX	X2,275 Vac; 0,1 $\mu$ F,40/110/56/B	EN 60384-14	VDE 0024534
(Alternative)	Okaya Electric Industries Co., Ltd.	LE104-MX	AC310V; 50/60Hz; 0,1 $\mu$ F; T110°C	EN 60384-14	ENEC SE/0142-1
(Alternative)	Xiamen Faratronic Co., Ltd.	MKP62	X2; AC 275V; 0,10 $\mu$ F; K; 40/110/56; B	EN 60384-14	VDE: 0000358
(Alternative)	Foshan City Xin Yuan Electronic Co., Ltd.	MKP-X2	AC275V;0,1 $\mu$ F;40/100/21	EN 60384-14	VDE: 40027433
(Alternative)	Shanghai Xiangriya Electronic Co., Ltd. (Xry)	MPX/MKP X2	104K;275VAC; T 85°C or above; X2	EN 60384-14	VDE 40001876
(Alternative)	Guangdong Fengming Electronic Tech. Co., Ltd.	MKP-X2	275VAC; 0,1 $\mu$ F K 40/110/56B	EN 60384-14	VDE 40025702
(Alternative)	Nistronics (Jiangxi) Co., Ltd.	MPRV0275K10 4M000H210	X2 275VAC 0,1 $\mu$ F, 40/100/21	EN 60384-14	VDE 40032056
(Alternative)	Guangdong Fengming Electronic Tech. Co., Ltd.	MKP-X2	275VAC 0,033 $\mu$ F K 40/110/56 B	EN 60384-14	CQC040010 10677
(Alternative)	Foshan City Xin Yuan Electronic Co., Ltd.	MKP-X2	AC275V; 0,033 $\mu$ F; 40/100/21	EN 60384-14	VDE: 40027433
(Alternative)	Okaya Electric Industries Co., Ltd.	LE104-MX	AC310V; 50/60Hz; 0,1 $\mu$ F; T110°C	EN 60384-14	ENEC SE/0142-1

## IEC 60335-2-40

(Alternative)	Guangdong Fengming Electronic Tech. Co., Ltd.	MKP-X2	275VAC; 0,1 $\mu$ F; K 40/110/56 B	EN 60384-14	VDE 40025702
(Alternative)	Xiamen Faratronic Co., Ltd.	MKP62	X2; AC 275V; 0,10 $\mu$ F; K; 40/110/56; B	EN 60384-14	VDE: 40000358
Outdoor X2 capacitor I for G, H, G1, H1	Xiamen Faratronic Co., Ltd.	MKP62	X2; AC 275V; 1,5 $\mu$ F; M; 40/110/56; B	EN 60384-14	VDE: 40000358
(Alternative)	Changzhou Jiaguan Electronics Co., Ltd.	MKP-X2	AC275/300V, 1,5 $\mu$ F, 40/110/21/C	EN 60384-14	VDE: 40037250
(Alternative)	Shanghai Xiangriya Electronic Co., Ltd. (Xry)	MPX/MKP X2	155M; 275VAC; T 85°C or above; X2	EN 60384-14	VDE 40001876
(Alternative)	Foshan City Xin Yuan Electronic Co., Ltd.	MKP-X2	AC275V; 1,5 $\mu$ F; 40/100/21	EN 60384-14	VDE: 40027433
(Alternative)	Guangdong Fengming Electronic Tech. Co., Ltd.	MKP-X2	275VAC 1,5 $\mu$ F M 40/110/56B	EN 60384-14	VDE 40025702
(Alternative)	Ultra Tech Xiphi Enterprise Co., Ltd.	HQX	X2, 250/275/280/300/305/310 Vac; 50/60Hz; 0,001 $\mu$ F to 10 $\mu$ F, 40/110/56/B J( $\pm$ 5%), K( $\pm$ 10%) or M( $\pm$ 20%),	EN 60384-14	VDE 40024534
(Alternative)	Guangdong Fengming Electronic Tech. Co., Ltd.	MKP-X2	275VAC 1,5 $\mu$ F M 40/110/56B	EN 60384-14	VDE: 40027433
(Alternative)	Ultra Tech Xiphi Enterprise Co., Ltd.	HQX	X2, 310 Vac; 1,5 $\mu$ F, 40/110/56/B K	EN 60384-14	VDE 40024534
(Alternative)	Guangdong Fengming Electronic Tech. Co., Ltd.	MKP-X2	275VAC 1,5 $\mu$ F M 40/110/56B	EN 60384-14	CQC 04001010677
(Alternative)	Shanghai Xiangriya Electronic Co., Ltd. (Xry)	MPX/MKP X2	333M; 275VAC; T 85°C or above; X2	EN 60384-14	VDE 40001876
(Alternative)	Guangdong Fengming Electronic Tech. Co., Ltd.	MKP-X2	275VAC 0,033 $\mu$ F K 40/110/56 B	EN 60384-14	VDE 40025702
(Alternative)	Ultra Tech Xiphi Enterprise Co., Ltd.	HQX	X2,275 Vac; 0,033 $\mu$ F,40/110/56 /B K	EN 60384-14	VDE 40024534
(Alternative)	Ultra Tech Xiphi Enterprise Co., Ltd.	HQX	X2, 250/275/280/300/305/310 Vac; 50/60Hz; 0,001 $\mu$ F to 10 $\mu$ F, 40/110/56/B J( $\pm$ 5%), K( $\pm$ 10%) or M( $\pm$ 20%),	EN 60384-14	VDE 40024534
(Alternative)	Xiamen Faratronic Co., Ltd.	MKP62	X2; AC 275V; 0,033 $\mu$ F; M; 40/110/56; B	EN 60384-14	VDE: 40000358

## IEC 60335-2-40

(Alternative)	Guangdong Fengming Electronic Tech. Co., Ltd.	MKP-X2	275VAC 0,033μF K 40/110/56 B	EN 60384-14	VDE: 40027433
(Alternative)	Guangdong Fengming Electronic Tech. Co., Ltd.	MKP-X2	275VAC 0,033μF K 40/110/56 B	EN 60384-14	CQC040010 10677
(Alternative)	Foshan City Xin Yuan Electronic Co., Ltd.	MKP-X2	AC275V; 0,033μF; 40/100/21	EN 60384-14	VDE: 40027433
(Alternative)	Okaya Electric Industries Co., Ltd.	LE104-MX	AC310V; 50/60Hz; 0,1μF; T110°C	EN 60384-14	ENEC SE/0142-1
(Alternative)	Guangdong Fengming Electronic Tech. Co., Ltd.	MKP-X2	275VAC; 0,1μF; K 40/110/56 B	EN 60384-14	CQC 0400101067 7
(Alternative)	Guangdong Fengming Electronic Tech. Co., Ltd.	MKP-X2	275VAC; 0,1μF; K 40/110/56 B	EN 60384-14	VDE 40025702
(Alternative)	Xiamen Faratronic Co., Ltd.	MKP62	X2; AC 275V; 0,10μF; K; 40/110/56; B	EN 60384-14	VDE: 40000358
(Alternative)	Guangdong Fengming Electronic Tech. Co., Ltd.	MKP-X2	275VAC; 0,1μF K 40/110/56 B	EN 60384-14	VDE: 40027433
(Alternative)	Shanghai Xiangriya Electronic Co., Ltd. (Xry)	MPX/MKP X2	104K; 275VAC; T 85°C or above; X2	EN 60384-14	VDE 40001876
(Alternative)	Foshan City Xin Yuan Electronic Co., Ltd.	MKP-X2	AC275V; 0,1μF; 40/100/21	EN 60384-14	VDE: 40027433
(Alternative)	Ultra Tech Xiphi Enterprise Co., Ltd.	HQX	X2, 250/275/280/300/305/310 Vac; 50/60Hz; 0,001μF to 10μF, 40/110/56/B J(±5%), K(±10%) or M(±20%),	EN 60384-14	VDE 40024534
(Alternative)	Ultra Tech Xiphi Enterprise Co., Ltd.	HQX	X2,275 Vac; 0,1μF, 40/110/56/B K	EN 60384-14	VDE 40024534
(Alternative)	Shanghai Xiangriya Electronic Co., Ltd. (Xry)	MPX/MKP X2	474M; 275VAC; T 85°C or above; X2	EN 60384-14	VDE 40001876
(Alternative)	Changzhou Jiaguan Electronics Co., Ltd.	MKP-X2	AC275/300V, 0,47μF, 40/110/21/C	EN 60384-14	VDE: 40037250
(Alternative)	Guangdong Fengming Electronic Tech. Co., Ltd.	MKP-X2	275VAC; 0,47μF; M 40/110/56B	EN 60384-14	VDE: 40027433
(Alternative)	Okaya Electric Industries Co., Ltd.	LE474-MX	AC310V; 50/60Hz; 0,47μF; T110°C	EN 60384-14	ENEC SE/0142-1
(Alternative)	Guangdong Fengming Electronic Tech. Co., Ltd.	MKP-X2	275VAC 0,47μF M 40/110/56B	EN 60384-14	VDE 40025702
(Alternative)	Guangdong Fengming Electronic Tech. Co., Ltd.	MKP-X2	275VAC 0,47μF M 40/110/56B	EN 60384-14	CQC040010 10677

## IEC 60335-2-40

(Alternative)	Ultra Tech Xiphi Enterprise Co., Ltd.	HQX	X2,275 Vac; 0,47µF,40/110/56/ B K	EN 60384-14	VDE 40024534
(Alternative)	Foshan City Xin Yuan Electronic Co., Ltd.	MKP-X2	AC275V; 0,47µF; 40/100/21	EN 60384-14	VDE: 40027433
(Alternative)	Xiamen Faratronic Co., Ltd.	MKP62	X2; AC 275V; 0,47µF; M; 40/110/56; B	EN 60384-14	VDE: 40000358
(Alternative)	Ultra Tech Xiphi Enterprise Co., Ltd.	HQX	X2, 250/275/280/300/3 05/310 Vac; 50/60Hz; 0,001µF to 10µF, 40/110/56/B J(±5%), K(±10%) or M(±20%),	EN 60384-14	VDE 40024534
4-way valve for A, A1, B, B1, C, C1, F, F1	Zhongshan City Gangli Refrigeration Fittings Co., Ltd.	SHF-4 R410A	AC220-240V; 50/60Hz; 4,5/3,5W; Class B	EN 60730-1	VDE 40026249
(Alternative)	Zhejiang Dunan Hetian Metal Co., Ltd.	DSF-4-R410A	AC220-240V; 50/60Hz; 7/5W; Class B	EN 60730-1	VDE 0013212
(Alternative)	Zhejiang Sanhua Climate & Appliance Controls Group Co., Ltd.	SHF-4H-23U- PM or SHF-4H- 23U-P	AC220-240V; 50/60Hz; 4,5/3,5W; Class F	EN 60730-1	VDE 40003240
(Alternative)	Okayama Seiko (Zhong Shan) Co., Ltd.	DSF-C4-23- 1/STF-01N1 VHR	AC220~240V; 4,5/3,5W; 50/60Hz, IP54; Class B	EN 60730-1	VDE: 40044501
4-way valve for D, D1, E, E1	Zhongshan City Gangli Refrigeration Fittings Co., Ltd.	SHF-7 R410A	AC220-240V; 50/60Hz; 4,5/3,5W; Class B	EN 60730-1	VDE 40026249
(Alternative)	Zhejiang Dunan Hetian Metal Co., Ltd.	DSF-9-R410A	AC220-240V; 50/60Hz; 7/5W; Class B	EN 60730-1	VDE 0013212
(Alternative)	Zhejiang Sanhua Climate & Appliance Controls Group Co., Ltd.	SHF-7H-34U-P	AC220-240V; 50/60Hz; 4,5/3,5W Class F	EN 60730-1	VED 40003240
4-way valve for G, H, G1, H1	Zhejiang Sanhua Climate & Appliance Controls Group Co., Ltd.	SHF-4H-23U- PM_SHF-4- 10L3	AC220-240V 50/60Hz 4,5/3,5W Class F	EN 60730-1	VDE 40003240
(Alternative)	Zhejiang Dunan Hetian Metal Co., Ltd.	DSF-4-R410A	AC220-240V; 50/60Hz; 7/5W; Class B	EN 60730-1	VDE 40013212
(Alternative)	Okayama Seiko (Zhong Shan) Co., Ltd.	DSF-C4-23- 1/STF-01N1 VHR	AC220~240V; 4,5/3,5W; 50/60Hz, IP54	EN 60730-1	VDE: 40044501
(Alternative)	Zhongshan City Gangli Refrigeration Fittings Co., Ltd.	SHF-4 R410A	AC220-240V; 50/60Hz; 4,5/3,5W; Class B	EN 60730-1	VDE 40026249

## IEC 60335-2-40

(Alternative)	Zhejiang Dun'an Artificial Environment Co., Ltd.	DSF-4-R410A	AC220-240V; 50/60Hz; 7/5W; Class B	EN 60730-1	VDE 40013212
Outdoor crankshaft heater for B, B1, D, D1, E, E1, F, F1 (optional)	Anhui Dubang Electrical Products Co., Ltd.	DJRD-358A-1000-20W-5	220VAC; 20W $\pm$ 7%	EN 60335-2-40 EN 60335-1	Test with appliance
(Alternative)	Zhenjiang Dongfang Electric Heating Technology Co., Ltd.	DJRD-358A-1000-20W-5	AC220V; 20W $\pm$ 7%	EN 60335-2-40 EN 60335-1	Test with appliance
Outdoor crankshaft heater for G, H	Zhenjiang Dongfang Electric Heating Technology Co., Ltd.	DJRD-358A-1000-20W-5	AC220V; 20W $\pm$ 7%	EN 60335-2-40 EN 60335-1	Test with appliance
(Alternative)	Anhui Dubang Electrical Products Co., Ltd.	DJRD-358A-1000-20W-5	220VAC; 20W $\pm$ 7%	EN 60335-2-40 EN 60335-1	Test with appliance
Outdoor chassis heater for G, H, G1, H1	Anhui Suli Technology Co., Ltd.	DJRG-150W-030-2	230VAC 150W	EN 60335-2-40 EN 60335-1	Test with appliance
(Alternative)	Zhenjiang Dongfang Electric Heating Technology Co., Ltd.	DJRG-150W-030-2	230VAC 150W	EN 60335-2-40 EN 60335-1	Test with appliance
Outdoor chassis heater for B, B1, D, D1, F, F1 (optional)	Zhenjiang Dongfang Electric Heating Technology Co., Ltd.	DJRG-150W-030-2	230VAC; 150W	EN 60335-2-40 EN 60335-1	Test with appliance
(Alternative)	Anhui Suli Technology Co., Ltd.	DJRG-150W-030-2	230VAC; 150W	EN 60335-2-40 EN 60335-1	Test with appliance
Outdoor chassis heater for E, E1 (optional)	Zhenjiang Dongfang Electric Heating Technology Co., Ltd.	DJRG-150W-350-2	220-240VAC; 150W	EN 60335-2-40 EN 60335-1	Test with appliance
(Alternative)	Anhui Suli Technology Co., Ltd.	DJRG-150W-350-2	230VAC; 150W	EN 60335-2-40 EN 60335-1	Test with appliance
(Alternative)	Anhui Suli Technology Co., Ltd.	DJRG-150W-X4-1	230VAC 150W	EN 60335-2-40 EN 60335-1	Test with appliance
(Alternative)	Zhenjiang Dongfang Electric Heating Technology Co., Ltd.	DJRG-150W-X4-1	230VAC 150W	EN 60335-2-40 EN 60335-1	Test with appliance
Anion generator for A, A1, B, B1, C, C1, F, F1 (optional)	Zhenjiang Hanbang Technology Co., Ltd.	ZFLZ-07 (HB-202D10M)	220-240V; 50/60Hz 1W	EN 60335-2-65 EN 60335-1 EN 60079	TUV B13044131 9022 GZES18010 0065731
(Alternative)	Dongguan Nanbai Electronic Technology Co., Ltd.	ZFLZ-07 (NB-S)	220-240V; 50/60Hz 1W	EN 60335-2-65 EN 60335-1 EN 60079	TUV B17038321 0008 GZES18010 0099931

## IEC 60335-2-40

(Alternative)	Dongguan Nanbai Electronic Technology Co., Ltd.	ZFLZ-07 (NB-G)	220V; 50/60HZ 1W	EN 60335-2-65 EN 60335-1 EN 60079	TUV B17038321 0008 GZES18010 0099931
Anion generator for D, D1, E, E1 (optional)	Zhenjiang Hanbang Technology Co., Ltd.	ZFLZ-08 (HB-202D10N)	220-240V; 50/60Hz 1W	EN 60335-2-65 EN 60335-1 EN 60079	TUV B13044131 9022 GZES18010 0065731
(Alternative)	Dongguan Nanbai Electronic Technology Co., Ltd.	ZFLZ-08 (NB-A)	220-240V; 50/60Hz 1W	EN 60335-2-65 EN 60335-1 EN 60079	TUV B17038321 0008 GZES18010 0099931
Internal wire	Yueqing Guoxin Electric Wire Factory	UL1015	AWG12-22#; 600VAC; 105°C	EN 60335-2-40 EN 60335-1	UL E247528 Test with appliance
(Alternative)	Changzhou Hongchang Electronics Co., Ltd.	UL1015	AWG12-22#; 600VAC; 105°C	EN 60335-2-40 EN 60335-1	UL E212395 Test with appliance
(Alternative)	Huasheng Eletrical Industrial Co., Ltd.	UL1015	AWG12-22#; 600VAC; 105°C	EN 60335-2-40 EN 60335-1	UL E230918 Test with appliance
(Alternative)	Guangdong Province Guangzhou Panyu Cable Works Co., Ltd. Panyu Cable Factory	UL1015	AWG12-22#; 600VAC; 105°C	EN 60335-2-40 EN 60335-1	UL E216775 Test with appliance
(Alternative)	Guangdong Xinya Electronics Technology Co., Ltd.	UL1015	AWG12-22#; 600VAC; 105°C	EN 60335-2-40 EN 60335-1	UL E170689 Test with appliance
(Alternative)	Zhongshan City Shenbao Electric Co., Ltd.	UL1015	AWG12-22#; 600VAC; 105°C;	EN 60335-2-40 EN 60335-1	UL E199818 Test with appliance
(Alternative)	Lichang Connector Industry Co., Ltd.	UL1015	AWG12-22#; 600VAC; 105°C	EN 60335-2-40 EN 60335-1	UL E228858 Test with appliance
(Alternative)	Huizhou Ltk Electronic Cable Ltd.	UL1015	AWG12-22#; 600VAC; 105°C	EN 60335-2-40 EN 60335-1	UL E148000 Test with appliance
(Alternative)	Heshan City Tehsing Huanchiu Electric Cable Co., Ltd.	UL1015	AWG12-22#; 600VAC; 105°C	EN 60335-2-40 EN 60335-1	UL E229340 Test with appliance
(Alternative)	Guangdong Linoya Electronic Technology Co., Ltd.	UL1015	AWG12-22#; 600VAC; 105°C	EN 60335-2-40 EN 60335-1	UL E315619 Test with appliance
(Alternative)	Guangzhou Kaiheng Enterprise Group	UL1015	AWG12-22#; 600VAC; 105°C	EN 60335-2-40 EN 60335-1	UL E248582 Test with appliance
(Alternative)	Shenzhen Qifurui Electronics Co., Ltd.	UL1015	AWG12-22#; 600VAC; 105°C	EN 60335-2-40 EN 60335-1	UL E211048 Test with appliance
(Alternative)	Foshan Zhuo Sheng Green Wire Co., Ltd.	UL1015	AWG12-22#; 600VAC; 105°C	EN 60335-2-40 EN 60335-1	UL E251755 Test with appliance

## IEC 60335-2-40

(Alternative)	Ls Cable (Wuxi) Co., Ltd.	UL1015	AWG12-22#; 600VAC; 105°C	EN 60335-2-40 EN 60335-1	UL E52853 Test with appliance
(Alternative)	Guangzhou Zhongte Electrical Material Co., Ltd.	UL1015	AWG12-22#; 600VAC; 105°C	EN 60335-2-40 EN 60335-1	UL E307902 Test with appliance
(Alternative)	Chau'S Electrical Co., Ltd.	UL1015	AWG12-22#; 600VAC; 105°C	EN 60335-2-40 EN 60335-1	UL E114082 Test with appliance
(Alternative)	Wuhu Shuncheng Electronics Co., Ltd	UL1015	AWG12-22#; 600VAC; 105°C	EN 60335-2-40 EN 60335-1	UL E314693 Test with appliance
(Alternative)	Foshan Shunde Yonggaolian Wire & Cable Co., Ltd.	UL1015	AWG12-22#; 600VAC; 105°C	EN 60335-2-40 EN 60335-1	UL E314925 Test with appliance
(Alternative)	Zhongshan Dongfeng Zhoushishenlong Electronic Wire Co., Ltd.	UL1015	AWG12-22#; 600VAC; 105°C	EN 60335-2-40 EN 60335-1	UL E257280 Test with appliance
(Alternative)	Dongguan Jinlong Electronics Co., Ltd.	UL1015	AWG12-22#; 600VAC; 105°C	EN 60335-2-40 EN 60335-1	UL E333717 Test with appliance
(Alternative)	Jiangmen Huayuan Enterprise Co., Ltd.	UL1015	AWG12-22#; 600VAC; 105°C	EN 60335-2-40 EN 60335-1	UL E341507 Test with appliance
(Alternative)	Foshan Shunde Zhanliang Industrialist	UL1015	AWG12-22#; 600VAC; 105°C	EN 60335-2-40 EN 60335-1	UL E330864 Test with appliance
(Alternative)	Anhui Xinke New Materials Stock Co., Ltd. Cable & Wires Branch Co	UL1015	AWG12-22#; 600VAC; 105°C	EN 60335-2-40 EN 60335-1	UL E220455 Test with appliance
(Alternative)	Jiangyin Jiangzhou Copper Product Co., Ltd.	UL1015	AWG12-22#; 600VAC; 105°C	EN 60335-2-40 EN 60335-1	UL E341212 Test with appliance
(Alternative)	Guangdong Yong Roi Cable Technology Co., Ltd.	UL1015	AWG12-22#; 600VAC; 105°C	EN 60335-2-40 EN 60335-1	UL E204893 Tested with appliance
(Alternative)	Wuxi Huahao Electric Co., Ltd.	UL1015	AWG12-22#; 600VAC; 105°C	EN 60335-2-40 EN 60335-1	UL E231903 Tested with appliance
(Alternative)	Foshan Shunde Huakun Electric Co., Ltd.	UL1015	AWG12-22#; 600VAC; 105°C	EN 60335-2-40 EN 60335-1	UL E305878 Tested with appliance
(Alternative)	Jiaying Tition Wire Co., Ltd.	UL1015	600VAC; 105°C; AWG 12-22	EN 60335-2-40 EN 60335-1	UL E320271 (Test with appliance)
(Alternative)	Jiaying Tition Wire Co., Ltd.	UL1007	300VAC; 80°C; AWG16-32	EN 60335-2-40 EN 60335-1	UL E320271 (Test with appliance)
(Alternative)	Foshan Shunde Huakun Electric Co., Ltd.	UL1007	AWG16-32#; 300VAC; 80°C	EN 60335-2-40 EN 60335-1	UL E305878 Test with appliance

## IEC 60335-2-40

(Alternative)	Anhui Xinke New Materials Stock Co., Ltd. Cable & Wires Branch Co	UL1007	AWG16-32#; 300VAC; 80°C	EN 60335-2-40 EN 60335-1	UL E220455 Test with appliance
(Alternative)	Jiangyin Jiangzhou Copper Product Co., Ltd.	UL1007	AWG16-32#; 300VAC; 80°C	EN 60335-2-40 EN 60335-1	UL E341212 Test with appliance
(Alternative)	Guangdong Yong Roi Cable Technology Co., Ltd.	UL1007	AWG16-32#; 300VAC; 80°C	EN 60335-2-40 EN 60335-1	UL E204893 Tested with appliance
(Alternative)	Wuxi Huahao Electric Co., Ltd.	UL1007	AWG16-32#; 300VAC; 80°C	EN 60335-2-40 EN 60335-1	UL E231903 Tested with appliance
(Alternative)	Yueqing Guoxin Electric Wire Factory	UL1007	AWG16-32#; 300VAC; 80°C;	EN 60335-2-40 EN 60335-1	UL E247528 Test with appliance
(Alternative)	Changzhou Hongchang Electronics Co., Ltd.	UL1007	AWG16-32#; 300VAC; 80°C	EN 60335-2-40 EN 60335-1	UL E212395 Test with appliance
(Alternative)	Huasheng Eletrical Industrial Co., Ltd.	UL1007	AWG16-32#; 300VAC; 80°C	EN 60335-2-40 EN 60335-1	UL E230918 Test with appliance
(Alternative)	Guangdong Province Guangzhou Panyu Cable Works Co., Ltd. Panyu Cable Factory	UL1007	AWG16-32#; 300VAC; 80°C	EN 60335-2-40 EN 60335-1	UL E216775 Test with appliance
(Alternative)	Guangdong Xinya Electronics Technology Co., Ltd.	UL1007	AWG16-32#; 300VAC; 80°C	EN 60335-2-40 EN 60335-1	UL E170689 Test with appliance
(Alternative)	Zhongshan City Shenbao Electric Co., Ltd.	UL1007	AWG16-32#; 300VAC; 80°C	EN 60335-2-40 EN 60335-1	UL E199818 Test with appliance
(Alternative)	Foshan Shunde Baosheng Electronics Co., Ltd.	UL1007	AWG16-32#; 300VAC; 80°C	EN 60335-2-40 EN 60335-1	UL E257286 Test with appliance
(Alternative)	Lichang Connector Industry Co., Ltd.	UL1007	AWG16-32#; 300VAC; 80°C	EN 60335-2-40 EN 60335-1	UL E228858 Test with appliance
(Alternative)	Huizhou Ltk Electronic Cable Ltd.	UL1007	AWG16-32#; 300VAC; 80°C	EN 60335-2-40 EN 60335-1	UL E148000 Test with appliance
(Alternative)	Heshan City Tehsing Huanchiu Electric Cable Co., Ltd.	UL1007	AWG16-32#; 300VAC; 80°C	EN 60335-2-40 EN 60335-1	UL E229340 Test with appliance
(Alternative)	Guangdong Linoya Electronic Technology Co., Ltd.	UL1007	AWG16-32#; 300VAC; 80°C	EN 60335-2-40 EN 60335-1	UL E315619 Test with appliance
(Alternative)	Guangzhou Kaiheng Enterprise Group	UL1007	AWG16-32#; 300VAC; 80°C	EN 60335-2-40 EN 60335-1	UL E248582 Test with appliance
(Alternative)	Shenzhen Qifurui Electronics Co., Ltd.	UL1007	AWG16-32#; 300VAC; 80°C	EN 60335-2-40 EN 60335-1	UL E211048 Test with appliance
(Alternative)	Foshan Zhuo Sheng Green Wire Co., Ltd.	UL1007	AWG16-32#; 300VAC; 80°C	EN 60335-2-40 EN 60335-1	UL E251755 Test with appliance

## IEC 60335-2-40

(Alternative)	Ls Cable (Wuxi) Co., Ltd.	UL1007	AWG16-32#; 300VAC; 80°C	EN 60335-2-40 EN 60335-1	UL E52853 Test with appliance
(Alternative)	Guangzhou Zhongte Electrical Material Co., Ltd.	UL1007	AWG16-32#; 300VAC; 80°C	EN 60335-2-40 EN 60335-1	UL E307902 Test with appliance
(Alternative)	Chau'S Electrical Co., Ltd.	UL1007	AWG16-32#; 300VAC; 80°C	EN 60335-2-40 EN 60335-1	UL E114082 Test with appliance
(Alternative)	Wuhu Shuncheng Electronics Co., Ltd.	UL1007	AWG16-32#; 300VAC; 80°C	EN 60335-2-40 EN 60335-1	UL E314693 Test with appliance
(Alternative)	Foshan Shunde Yonggaolian Wire & Cable Co., Ltd.	UL1007	AWG16-32#; 300VAC; 80°C	EN 60335-2-40 EN 60335-1	UL E314925 Test with appliance
(Alternative)	Zhongshan Dongfeng Zhoushi Shenlong Electronic Wire Co., Ltd.	UL1007	AWG16-32#; 300VAC; 80°C	EN 60335-2-40 EN 60335-1	UL E257280 Test with appliance
(Alternative)	Dongguan Jinlong Electronics Co., Ltd.	UL1007	AWG16-32#; 300VAC; 80°C	EN 60335-2-40 EN 60335-1	UL E333717 Test with appliance
(Alternative)	Jiangmen Huayuan Enterprise Co., Ltd.	UL1007	AWG16-32#; 300VAC; 80°C	EN 60335-2-40 EN 60335-1	UL E341507 Test with appliance
(Alternative)	Foshan Shunde Zhanliang Industrialist	UL1007	AWG16-32#; 300VAC; 80°C	EN 60335-2-40 EN 60335-1	UL E330864 Test with appliance
(Alternative)	Yong Hao Electrical Industry Co., Ltd.	UL1015	AWG12-22#; 600VAC; 105°C	EN 60335-2-40 EN 60335-1	UL E240426 Test with appliance
(Alternative)	Yong Hao Electrical Industry Co., Ltd.	UL1007	AWG16-32#; 300VAC; 80°C;	EN 60335-2-40 EN 60335-1	UL E240426 Test with appliance
(Alternative)	Guangdong Linoya Electronic Technology Co., Ltd.	UL1430	300VAC; 105°C; AWG16-30	EN 60335-2-40 EN 60335-1	UL E315619 (Test with appliance)
(Alternative)	3A PVC Wire & Cable Co., Ltd	UL3286	300VAC; 105°C; AWG16-30	EN 60335-2-40 EN 60335-1	UL E209277 (Test with appliance)
(Alternative)	Shenzhen Mysun Insulation Materials Co., Ltd.	UL3071	300VAC; 105°C; AWG14	EN 60335-2-40 EN 60335-1	UL E239689 (Test with appliance)
(Alternative)	Yonghao Electrical Industry Co., Ltd.	UL3271	300VAC,125°C AWG10-30#	EN 60335-2-40 EN 60335-1	UL E240426 (Test with appliance)
PVC tube	Dae Chang Eleccom Co., Ltd	DC-6	600VAC; 105°C	EN 60335-2-40 EN 60335-1	UL E120268 (Test with appliance)
(Alternative)	Zhejiang Zhongtian Electrical Jacket Co., Ltd.	ZT300	300VAC; 105°C	EN 60335-2-40 EN 60335-1	UL E317046 (Test with appliance)
(Alternative)	Foshan Shunde Kaidaxin Plastic Industry Co., Ltd.	KDS01	600VAC; 105°C	EN 60335-2-40 EN 60335-1	UL E314911 (Test with appliance)

## IEC 60335-2-40

(Alternative)	Guangzhou Kaiheng Enterprise Group	S-2	600VAC; 105°C	EN 60335-2-40 EN 60335-1	UL E214175 (Test with appliance)
(Alternative)	Guangzhou Pu Sheng Electronics Insulating Material Co., Ltd.	GX-600	600VAC; 105°C	EN 60335-2-40 EN 60335-1	UL E248681 (Test with appliance)
(Alternative)	Heng Hui Chang Insulation Material Co., Ltd.	HHC-01 (GX-600V)	600VAC; 105°C	EN 60335-2-40 EN 60335-1	UL E327311 (Test with appliance)
(Alternative)	Lianda Co., Ltd	LHX-01	600VAC; 105°C	EN 60335-2-40 EN 60335-1	UL E218446 (Test with appliance)
(Alternative)	Nissei Eco Co., Ltd.	NH-3 (NIS-S-SE1)	600VAC; 105°C	EN 60335-2-40 EN 60335-1	UL E199505 (Test with appliance)
(Alternative)	Shenzhen Woer Heat-Shrinkable Material Co., Ltd.	RSFR-H or SBRS	600VAC; 125°C	EN 60335-2-40 EN 60335-1	UL E203950 (Test with appliance)
(Alternative)	Suzhou Fuchen Electric Material Co., Ltd.	FC-600	600VAC; 105°C	EN 60335-2-40 EN 60335-1	UL E304705 (Test with appliance)
(Alternative)	Wenzhou Hongxin Plastic Co., Ltd.	HXT-600 (GX-600)	600VAC; 105°C	EN 60335-2-40 EN 60335-1	UL E305314 (Test with appliance)
(Alternative)	Zhangjiagang City Yilida Electronics Co., Ltd.	CSGV-600	600VAC; 105°C	EN 60335-2-40 EN 60335-1	UL E301348 (Test with appliance)
(Alternative)	Zhejiang Zhongtian Electrical Jacket Co., Ltd.	ZT600	600VAC; 105°C	EN 60335-2-40 EN 60335-1	UL E317046 (Test with appliance)
(Alternative)	Changzhou Shi Yu Wang Plastic Co., Ltd	WS3-14	600VAC; 105°C	EN 60335-2-40 EN 60335-1	UL E238569 (Test with appliance)
(Alternative)	Wuhu Donghe Electron Co., Ltd.	PVC-DHB	600VAC; 105°C	EN 60335-2-40 EN 60335-1	UL E352940 (Test with appliance)
(Alternative)	Kunshan Shengda Plastic Products Co., Ltd.	SDT-105	600VAC; 105°C	EN 60335-2-40 EN 60335-1	UL E340362 (Test with appliance)
(Alternative) only for fan motor	Lianda Co., Ltd.	HB	750VAC; 105°C; VW-1	EN 60335-2-40 EN 60335-1	UL (Test with appliance)
(Alternative) only for fan motor	Lianda Co., Ltd.	SH	750VAC; 105°C; VW-1	EN 60335-2-40 EN 60335-1	UL (Test with appliance)
(Alternative) only for fan motor	Kai Da Xin	Φ6, Φ8, Φ10, Φ12	750VAC; 105°C; VW-1	EN 60335-2-40 EN 60335-1	UL (Test with appliance)
(Alternative)	Dongguan Quanxin Plastic Co., Ltd.	VW-1	600VAC; 105°C	EN 60335-2-40 EN 60335-1	UL E361235 (Test with appliance)
(Alternative)	Yi Li Da	Φ4, Φ6, Φ8, Φ14, Φ10, Φ12	600VAC; 105°C	EN 60335-2-40 EN 60335-1	UL (Test with appliance)
(Alternative)	Wen Shi Da	VAST-600	600VAC; 105°C	EN 60335-2-40 EN 60335-1	UL (Test with appliance)

## IEC 60335-2-40

(Alternative)	Dongguan City Zhengfeng Wire & Cable Co., Ltd.	ZF-600	600VAC; 105°C	EN 60335-2-40 EN 60335-1	UL E342662 (Test with appliance)
(Alternative)	Zhongshan Fengyu Electrical Parts Co., Ltd.	FY-600	600VAC; 105°C	EN 60335-2-40 EN 60335-1	UL E314739 (Test with appliance)
(Alternative)	HAI SHENG	QS1-600	600VAC; 105°C;	EN 60335-2-40 EN 60335-1	UL E238728 (Tested with appliance)
PCB board	Baoyuejia Electronics (Zhongshan) Co., Ltd	BYJ-3	94V-0; thickness: 1,6mm	EN 60335-2-40 EN 60335-1	UL E230225 (Test with appliance)
(Alternative)	Chang Chun Plastics Co., Ltd.	CCP-508SW/ CCP-508/CCP-3400	94V-0; thickness: 1,6mm	EN 60335-2-40 EN 60335-1	UL E108591 (Test with appliance)
(Alternative)	Changzhou Haihong Electronics Co., Ltd.	HDCEM1	94V-0; thickness: 1,6mm	EN 60335-2-40 EN 60335-1	UL E166702 (Test with appliance)
(Alternative)	Shengyi Technology Co., Ltd.	S3110/S1141/S3116/S1600	94V-0; thickness: 1,6mm	EN 60335-2-40 EN 60335-1	UL E109769 (Test with appliance)
(Alternative)	Guangzhou Panyu Cali-Tech Electronics Co., Ltd.	CT-101&CT-101A	94V-0; thickness: 1,6mm	EN 60335-2-40 EN 60335-1	UL E216635 (Test with appliance)
(Alternative)	Ht Circuits Ltd	1294V0	94V-0; thickness: 1,6mm	EN 60335-2-40 EN 60335-1	UL E56334 (Test with appliance)
(Alternative)	Huizhou Xingzhiguang technology Co., Ltd	XZG-P1 or KB-6160C	94V-0; thickness: 1,6mm	EN 60335-2-40 EN 60335-1	UL E246887 (Test with appliance)
(Alternative)	International Laminate Material Ltd.	ILM-R1##	94V-0; thickness: 1,6mm	EN 60335-2-40 EN 60335-1	UL E134893 (Test with appliance)
(Alternative)	Kingboard Laminates Holdings Ltd.	KB-6150/KB-6160/KB-5150/KB-6150C/KB-6160C /KB-6164F	94V-0; thickness: 1,6mm	EN 60335-2-40 EN 60335-1	UL E123995 (Test with appliance)
(Alternative)	Shenzhen Wuzhu Tech Co., Ltd.	KB-6150/KB-6160/KB-5150/KB-6150C/KB-6160C	94V-0; thickness: 1,6mm	EN 60335-2-40 EN 60335-1	UL E170968 (Test with appliance)
(Alternative)	Shanghai Nanya Copper Clad Laminates Co., Ltd.	SN-L4 or FR-4-86PY or FR-4-11PY or NP-140TL	94V-0; thickness: 1,6mm	EN 60335-2-40 EN 60335-1	UL E213990 (Test with appliance)
(Alternative)	Shunde Junda Electronic Co., Ltd.	JD-D1orJD-D or JD-E	94V-0; thickness: 1,6mm	EN 60335-2-40 EN 60335-1	UL E173873 (Test with appliance)
(Alternative)	Guang Dong Xing Da Hong Ye Electronic Co., Ltd.	XD-102	94V-0; thickness: 1,6mm	EN 60335-2-40 EN 60335-1	UL E193079 (Test with appliance)

## IEC 60335-2-40

(Alternative)	Zhuhai Jointek Electric Co., Ltd.	JK-004	94V-0; thickness: 1,6mm	EN 60335-2-40 EN 60335-1	UL E214852 (Test with appliance)
(Alternative)	Ronghui Electronics (Huizhou) Co., Ltd.	RH-3	94V-0; thickness: 1,6mm	EN 60335-2-40 EN 60335-1	UL E252098 (Test with appliance)
(Alternative)	Victory Giant Technology (Huizhou) Co., Ltd.	SH1&SH6	94V-0; thickness: 1,6mm	EN 60335-2-40 EN 60335-1	UL E346395 (Test with appliance)
(Alternative)	Hangzhou Baolin Printed Circuit Co., Ltd.	BL2 or BL1	94V-0; thickness: 1,6mm	EN 60335-2-40 EN 60335-1	UL E207143 (Test with appliance)
(Alternative)	Express Electronics Co., Ltd.	EP or 10V0	94V-0; thickness: 1,6mm/2,0mm	EN 60335-2-40 EN 60335-1	UL E157925 (Test with appliance)
(Alternative)	Changzhou Aohong Electronics Co., Ltd	AOH-2	94V-0; thickness: 1,6mm/2,0mm	EN 60335-2-40 EN 60335-1	UL E303981 (Test with appliance)
(Alternative)	International Laminate Material Ltd	GF111T6/GF112T6, GF21/22	94V-0; thickness: 1,6mm/2,0mm	EN 60335-2-40 EN 60335-1	UL E134893 (Test with appliance)
(Alternative)	Guangdong Chengde Electronic Technology Co., Ltd.	D-12	94V-0; thickness: 1,6mm/2,0mm	EN 60335-2-40 EN 60335-1	UL E346273 (Test with appliance)
(Alternative)	Guangzhou Panyu Cali-tech Electronics Co., Ltd.	CT-101A	94V-0; Thickness:1,6mm	EN 60335-2-40 EN 60335-1	UL E216635; (Tested with appliance)
(Alternative)	Gold Max International Co., Ltd	GF122, GF112T6, GF222, GF212	94V-0; thickness: 1,0-2,0mm	EN 60335-2-40 EN 60335-1	UL E224772; (Tested with appliance)
(Alternative)	Express Electronics Co., Ltd.	EP, 10V0, 13MV0	94V-0; thickness: 1,6mm/2,0mm;	EN 60335-2-40 EN 60335-1	UL E157925 (Tested with appliance)
(Alternative)	Guangdong Hongtai Electronic Incorporated Co., Ltd	HH-2, HH-3	94V-0; thickness: 1,6mm/2,0mm;	EN 60335-2-40 EN 60335-1	UL E315852 (Tested with appliance)
(Alternative)	Zhongshan Running Electronics Technology Co., Ltd	RN-D, RN-M, RN-D1	94V-0; thickness: 1,6mm/2,0mm;	EN 60335-2-40 EN 60335-1	UL E342015 (Tested with appliance)
(Alternative)	Mei Zhou Li Yu Da Cricuit Board Co., Ltd.	LYD-2	94V-0; thickness: 1,6mm/2,0mm;	EN 60335-2-40 EN 60335-1	UL E320265 (Tested with appliance)
(Alternative)	Mei Zhou Li Yu Da Cricuit Board Co., Ltd.	LYD-3	94V-0; thickness: 1,6mm/2,0mm;	EN 60335-2-40 EN 60335-1	UL E320265 (Tested with appliance)
(Alternative)	Mei Zhou Li Yu Da Cricuit Board Co., Ltd.	LYD-4	94V-0; thickness: 1,6mm/2,0mm;	EN 60335-2-40 EN 60335-1	UL E320265 (Tested with appliance)
(Alternative)	Mei Zhou Li Yu Da Cricuit Board Co., Ltd.	LYD-3A	94V-0; thickness: 1,6mm/2,0mm;	EN 60335-2-40 EN 60335-1	UL E320265 (Tested with appliance)
(Alternative)	Hangzhou Linan Pengyu Electronics Co., Ltd.	PY-2	94V-0; thickness: 1,6mm/2,0mm;	EN 60335-2-40 EN 60335-1	UL E229910 (Tested with appliance)

## IEC 60335-2-40

(Alternative)	Dong Guan New Energy Printed Circuit Board Co., Ltd.	NE5000, NE5000A, NE1000, NE2000	94V-0; thickness: 1,6mm/2,0mm;	EN 60335-2-40 EN 60335-1	UL E206420 (Tested with appliance)
(Alternative)	Victory Giant Technology (Hui Zhou) Co., Ltd	SH1, SH4, SH9, SH13, SH38	94V-0; thickness: 1,6mm/2,0mm;	EN 60335-2-40 EN 60335-1	UL E248779 (Tested with appliance)
(Alternative)	Guang Zhou Xuanhao (Hop Shing) Electronic Products Co., Ltd.	EC-2	94V-0; thickness: 1,6mm/2,0mm;	EN 60335-2-40 EN 60335-1	UL E188100 (Tested with appliance)
(Alternative)	Mei Zhou Li Yu Da PCB Co., Ltd	LYD-4	94V-0; Thickness: 1,6mm,2,0mm	EN 60335-2-40 EN 60335-1	UL E320265 (Test with appliance)
(Alternative)	Victory Giant Technology (Hui Zhou) Co., Ltd.	SH1	94V-0; Thickness: 1,6mm,2,0mm	EN 60335-2-40 EN 60335-1	UL E248779 (Test with appliance)
(Alternative)	Hangzhou Lin'an Pengyu Electronics Co., Ltd.	PY-2	94V-0; thickness:1,6mm	EN 60335-2-40 EN 60335-1	UL E229910 (Test with appliance)
(Alternative)	Dong Guan New Energy Printed Circuit Board Co., Ltd.	NE	94V-0; thickness:1,6mm	EN 60335-2-40 EN 60335-1	UL E206420 (Test with appliance)
(Alternative)	Guangdong Hongtai Electronic Incorporated Co., Ltd.	HH-2	94V-0; thickness:1,6mm;	EN 60335-2-40 EN 60335-1	UL E315852 (Test with appliance)
(Alternative)	Hangzhou Pengrun Electronics Co., Ltd.	PR-1	94V-0; thickness:1,6mm;	EN 60335-2-40 EN 60335-1	UL E484637 (Test with appliance)
(Alternative)	Victory Giant Technology (Huizhou) Co., Ltd.	SHI	94V-0; thickness:1,6mm;	EN 60335-2-40 EN 60335-1	UL E248779 (Test with appliance)
(Alternative)	Express Electronics Co., Ltd.	EP	10V0; 94V-0; thickness:1,6mm;	EN 60335-2-40 EN 60335-1	UL E157925 (Test with appliance)
(Alternative)	Changzhou Aohong Electronics Co., Ltd.	AOH-2/AOH-3	94V-0; thickness:1,6mm;	EN 60335-2-40 EN 60335-1	UL E303981 (Test with appliance)
(Alternative)	HuiZhou XingZhiGuang Technology Company Limited	XZG-P1	94V-0; thickness: 1,6mm	EN 60335-2-40 EN 60335-1	UL (Tested with appliance)
(Alternative)	HANGZHOU LINAN PENGYU ELECTRONICS CO LTD	PY-2	94V-0; thickness: 1,6mm	EN 60335-2-40 EN 60335-1	UL E229910 (Test with appliance)

Supplementary information: ---

## IEC 60335-2-40

28.1	TABLE: Threaded part torque test			P
Threaded part identification	Diameter of thread (mm)	Column number (I, II, or III)	Applied torque (Nm)	
Earthed screw	3,9	II	1,2	
Screw of terminal block cover	4,0	II	1,2	
Supplementary information: ---				

29.1	TABLE: Clearances					P
Overvoltage category .....		II			—	
		Type of insulation:				
Rated impulse voltage (V):	Min. cl (mm)	Basic (mm)	Supplementary (mm)	Reinforced (mm)	Functional (mm)	Verdict / Remark
330	0,2* / 0,5 / 0,8**	—	—	—	—	N/A
500	0,2* / 0,5 / 0,8**	—	—	—	—	N/A
800	0,2* / 0,5 / 0,8**	—	—	—	—	N/A
1 500	0,5 / 0,8** / 1,0***	—	—	—	—	N/A
2 500	<b>1,5 / 2,0***</b>	<b>a, e</b>	<b>b</b>	—	<b>d</b>	P
4 000	<b>3,0 / 3,5***</b>	—	—	<b>c</b>	—	P
6 000	5,5 / 6,0***	—	—	—	—	N/A
8 000	8,0 / 8,5***	—	—	—	—	N/A
10 000	11,0 / 11,5***	—	—	—	—	N/A
Supplementary information:						
*) For tracks on printed circuit boards if pollution degree 1 and 2						
**) For pollution degree 3						
***) If the construction is affected by wear, distortion, movement of the parts or during assembly						
a. B/W live parts and earthed metal: 4,1 mm;						
b. B/W internal wire and accessible surfaces: 6,3 mm;						
c. B/W live part and accessible surfaces: 11,5 mm;						
d. B/W L and N on main PCB: 3,5 mm;						
e. B/W motor winding and iron core: 2,8 mm						

## IEC 60335-2-40

29.2	TABLE: Creepage distances, basic, supplementary and reinforced insulation										P
Working voltage (V)	Creepage distance (mm) Pollution degree							Type of insulation			Verdict
	1	2			3						
		Material group			Material group						
		I	II	IIIa/IIIb	I	II	IIIa/IIIb*	B**	S**	R**	
≤50	0,18	0,6	0,85	1,2	1,5	1,7	1,9		—	—	N/A
≤50	0,18	0,6	0,85	1,2	1,5	1,7	1,9	—		—	N/A
≤50	0,36	1,2	1,7	2,4	3,0	3,4	3,8	—	—		N/A
125	0,28	0,75	1,05	1,5	1,9	2,1	2,4		—	—	N/A
125	0,28	0,75	1,05	1,5	1,9	2,1	2,4	—		—	N/A
125	0,56	1,5	2,1	3,0	3,8	4,2	4,8	—	—		N/A
250	0,56	1,25	1,8	2,5	3,2	3,6	<b>4,0</b>	<b>a</b>	—	—	P
250	0,56	1,25	1,8	2,5	3,2	3,6	<b>4,0 (limit: 2,0)</b>	<b>e</b>			P
250	0,56	1,25	1,8	2,5	3,2	3,6	<b>4,0</b>	—	<b>b</b>	—	P
250	1,12	2,5	3,6	5,0	6,4	7,2	<b>8,0</b>	—	—	<b>c</b>	P
400	1,0	2,0	2,8	4,0	5,0	5,6	6,3		—	—	N/A
400	1,0	2,0	2,8	4,0	5,0	5,6	6,3	—		—	N/A
400	2,0	4,0	5,6	8,0	10,0	11,2	12,6	—	—		N/A
500	1,3	2,5	3,6	5,0	6,3	7,1	8,0		—	—	N/A
500	1,3	2,5	3,6	5,0	6,3	7,1	8,0	—		—	N/A
500	2,6	5,0	7,2	10,0	12,6	14,2	16,0	—	—		N/A
>630 and ≤800	1,8	3,2	4,5	6,3	8,0	9,0	10,0		—	—	N/A
>630 and ≤800	1,8	3,2	4,5	6,3	8,0	9,0	10,0	—		—	N/A
>630 and ≤800	3,6	6,4	9,0	12,6	16,0	18,0	20,0	—	—		N/A

Supplementary information:

\*) Material group IIIb is allowed if the working voltage does not exceed 50 V

\*\*) B = Basic insulation, S = Supplementary insulation, R = Reinforced insulation

a. B/W live parts and earthed metal: 4,3 mm;

b. B/W internal wire and accessible surfaces: 6,3 mm;

c. B/W live part and accessible surfaces: 11,5 mm;

e. B/W motor winding and iron core: 2,8 mm

## IEC 60335-2-40

29.2	TABLE: Creepage distances, functional insulation							P
Working voltage (V)	Creepage distance (mm) Pollution degree							Verdict / Remark
	1	2			3			
		Material group			Material group			
		I	II	IIIa/IIIb	I	II	IIIa/IIIb*	
≤10	0,08	0,4	0,4	0,4	1,0	1,0	1,0	N/A
50	0,16	0,56	0,8	1,1	1,4	1,6	1,8	N/A
125	0,25	0,71	1,0	1,4	1,8	2,0	2,2	N/A
250	0,42	1,0	1,4	<b>2,0</b>	2,5	2,8	3,2	<b>P</b>
400	0,75	1,6	2,2	3,2	4,0	4,5	5,0	N/A
500	1,0	2,0	2,8	4,0	5,0	5,6	6,3	N/A
>630 and ≤800	1,8	3,2	4,5	6,3	8,0	9,0	10,0	N/A
>800 and ≤1000	2,4	4,0	5,6	8,0	10,0	11,0	12,5	N/A
>1000 and ≤1250	3,2	5,0	7,1	10,0	12,5	14,0	16,0	N/A
>1250 and ≤1600	4,2	6,3	9,0	12,5	16,0	18,0	20,0	N/A
>1600 and ≤2000	5,6	8,0	11,0	16,0	20,0	22,0	25,0	N/A
>2000 and ≤2500	7,5	10,0	14,0	20,0	25,0	28,0	32,0	N/A
>2500 and ≤3200	10,0	12,5	18,0	25,0	32,0	36,0	40,0	N/A
>3200 and ≤4000	12,5	16,0	22,0	32,0	40,0	45,0	50,0	N/A
>4000 and ≤5000	16,0	20,0	28,0	40,0	50,0	56,0	63,0	N/A
>5000 and ≤6300	20,0	25,0	36,0	50,0	63,0	71,0	80,0	N/A
>6300 and ≤8000	25,0	32,0	45,0	63,0	80,0	90,0	100,0	N/A
>8000 and ≤10000	32,0	40,0	56,0	80,0	100,0	110,0	125,0	N/A
>10000 and ≤12500	40,0	50,0	71,0	100,0	125,0	140,0	160,0	N/A

Supplementary information:

\*) Material group IIIb is allowed if the working voltage does not exceed 50 V

d. B/W L and N on main PCB: 3,5 mm;

## IEC 60335-2-40

30																				TABLE: Resistance to heat and fire																			
Object/ part No.	Manufacturer / trademark	Type/ model	Ball pressure test °C				Glow wire test (GWT) °C						Glow-wire flammability index (GWFI) °C				Glow- wire ignition temp. (GWIT) °C		Needle- flame test (NFT)	Verdict																			
			75	125	cl. 11 +40	cl. 19 +25	550	650		750		850	550	650	750	850	675	775																					
							te		ti																														
Terminal block*	—	—	—	x	—	—	—	—	—	0s	0s	x	—	—	—	—	—	—	—	P																			
Fan motor bobbin*	—	—	—	—	—	—	x	—	—	—	—	—	—	—	—	—	—	—	—	P																			
Bobbin of step motor*	—	—	—	x	—	—	—	0s	0s	—	—	—	—	—	—	—	—	—	—	P																			
Transformer bobbin*	—	—	—	x	—	—	—	—	—	0s	0s	x	—	—	—	—	—	—	—	P																			
Plastic enclosure*	—	—	x	—	—	—	x	—	—	—	—	—	—	—	—	—	—	—	—	P																			
Relays*	—	—	—	—	—	—	—	—	—	0s	0s	x	—	—	—	—	—	—	—	P																			
PCB*	—	—	—	—	—	—	—	—	—	—	—	—	—	—	—	—	—	—	x	P																			
Wire connector*	—	—	—	x	—	—	—	—	—	0s	0s	x	—	—	—	—	—	—	—	P																			
4-way valve*	—	—	—	x	—	—	—	—	—	0s	0s	x	—	—	—	—	—	—	—	P																			
Terminal sleeving*	—	—	—	—	—	—	—	—	—	0s	0s	x	—	—	—	—	—	—	—	P																			

## IEC 60335-2-40

Anion generator*	—	—	—	x	—	—	—	0s	0s	—	—	—	—	—	—	—	—	—	P
X2 capacitor*	—	—	—	—	—	—	—	—	—	0s	0s	x	—	—	—	—	—	—	P

Supplementary information: \* Only the unfavourable result for this component was displayed.

- 1) Parts of material classified at least HB40 or if relevant HBF
- 2) Parts of material classified as V-0 or V-1
- 3) Flame persisting longer than 2 s (=  $t_e - t_i$ ) need only be reported for unattended appliances
- 4) Surrounding parts subjected to the needle-flame test of annex E
- 5) Base material classified as V-0 or if relevant VTM-0
- 6) The GWIT pre-selection option, the 850 °C GWF1 pre-selection option, and the 850 °C GWT are not applicable for attended appliances

## IEC 60335-2-40

<b>Appendix EMF</b>		P	
	<b>TEST: Evaluation of the magnetic fields</b>	—	
Applied standards:	IEC 62233:2005, EN 62233:2008 (incl. Corr.1:2008)	—	
Method	Used method: 5.5.2 Time domain evaluation	—	
Applied Limit	ICNIRP Guidelines	—	
Identification of the appliance	Type of apparatus		
	Rated Voltage	220 V – 240 V	
	Rated Frequency	50 Hz	
Parameters required prior to the test	Laboratory Ambient Temperature	25 °C ± 10 °C	
	Supply Voltage	(Rated Voltage ± 2 %) V	
	Supply Frequency	(Rated Frequency ± 2 %) Hz	
Parameters recorded during the test	Laboratory Ambient Temperature	23 °C	
	Supply Voltage	240 V	
	Supply Frequency	50 HZ	
Operating Mode			
Method 5.5.2			
Measuring Positions	Measuring Distance	Coupling Factor	Measurement Uncertainty
Around	30 cm	0,16	---
Frequency (kHz)	Limit (%)	Measured Maximum Value (%)	
0,01 to 400	100	10,8	
Supplementary information:			
The measured maximum value in this table may be weighted with the coupling factor if applicable, and the measurement uncertainty is applied if the measured result is more than 75 % of the limit.			

--- End of Report ---

IEC60335_2_40J - ATTACHMENT			
Clause	Requirement - Test	Result - Remark	Verdict

<b>ATTACHMENT TO TEST REPORT IEC 60335-2-40</b> <b>EUROPEAN GROUP DIFFERENCES AND NATIONAL DIFFERENCES</b> Part-2-40: Particular requirements for electrical heat pumps, air conditioners and dehumidifiers	
<b>Differences according to :</b>	EN 60335-2-40:2003 (incl. Corr.:2006) + A11:2004 + A12:2005 + A1:2006 + A2:2009 + A13:2012 (incl. Corr.:2013) EN 60335-1:2012 (incl. Corr.:2014)
<b>Attachment Form No. :</b>	EU_GD_IEC60335_2_40J
<b>Attachment Originator :</b>	VDE
<b>Master Attachment :</b>	2014-06
<b>Copyright © 2014 IEC System for Conformity Testing and Certification of Electrical Equipment (IECEE), Geneva, Switzerland. All rights reserved.</b>	

CENELEC COMMON MODIFICATIONS			
6.1	Delete "class 0" and "class 01"		N/A
7.1	Single-phase appliances to be connected to the supply mains: 230 V covered		P
	Multi-phase appliances to be connected to the supply mains: 400 V covered		N/A
7.10	Devices used to start/stop operational functions of the appliance distinguished from other manual devices by means of shape, size, surface texture, position, etc.		P
	An indication that the device has been operated is given by:		—
	- a tactile feedback, or		N/A
	- an audible and visual feedback		P
7.12	The instructions include the substance of the following:		—
	- this appliance can be used by children aged from 8 years and above and persons with reduced physical, sensory or mental capabilities or lack of experience and knowledge if they have been given supervision or instruction concerning use of the appliance in a safe way and understand the hazards involved		P
	- children shall not play with the appliance		P
	- cleaning and user maintenance shall not be made by children without supervision		P
7.12.1	Installation instructions for appliances intended to be permanently connected to fixed wiring, and have leakage current exceed 10 mA, state that installation of residual current device (RCD) having rated residual operating current not exceeding 30 mA is advisable (EN 60335-2-40)		N/A

IEC60335_2_40J - ATTACHMENT			
Clause	Requirement - Test	Result - Remark	Verdict
	For appliances not accessible to the general public and which are intended to be permanently connected to fixed wiring and which may have leakage currents exceeding 10 mA, the installation instructions shall specify the rating of the residual current device (RCD) to be installed (EN 60335-2-40/A12)		N/A
7.12.Z1	The specific instructions related to the safe operation of this appliance is collated together in the front section of the user instructions		P
	The height of the characters, measured on the capital letters, is at least 3 mm		P
	These instructions are also available in an alternative format, e.g. on a website		P
8.1.1	Also test probe 18 of EN 61032 is applied		P
	The appliance being in every possible position, except that appliances normally used on the floor and having a mass exceeding 40 kg are not tilted. (EN 60335-1:2012/AC:2014)		P
	The force on the probe in the straight position is increased to 10 N when probe 18 is used		P
	When using test probe 18 the appliance is fully assembled as in normal use without any parts removed, and		P
	parts intended to be removed for user maintenance are also not removed		P
8.2	Compliance is checked by applying the test probes of EN 61032		P
	For built-in appliances and fixed appliances, the test probe B and probe 18 of EN 61032 are applied only after installation		P
11.8	Footnotes to "External enclosure of motor-operated appliances" to be taken into account		P
13.2	Leakage current measurements (EN 60335-2-40)	(See appended table)	P
15.1.2	Appliances with an automatic cord reel tested with the cord in the most unfavourable position so that the reeling of the wet cord may affect electrical insulation during operation, the cord not being dried before reeling		N/A
15.2	Drain pan filled to brim and subjected to continuous overflow and fan(s) switched on (EN 60335-2-40)		P
16.2	Leakage current measurements (EN 60335-2-40)	(See appended table)	P

IEC60335_2_40J - ATTACHMENT			
Clause	Requirement - Test	Result - Remark	Verdict
20.2	When using the test probe similar to test probe B with a circular stop face, the accessories and detachable covers are removed		P
	Test probe 18 applied with a force of 2,5 N on the appliance fully assembled		P
24.1	Components comply with the safety requirements specified in the relevant standards as far as they reasonably apply		P
	The requirements of clause 29 of this standard apply between live parts of components and accessible parts of the appliance.		P
	The requirements of 30.2 of this standard apply to parts of non-metallic material in components including parts of non-metallic material supporting current-carrying connections inside components		P
	Components that have not been previously tested or do not comply with the standard for the relevant component are tested according to the requirements of 30.2		P
	Components that have been previously tested and shown to comply with the resistance to fire requirements in the standard for the relevant component need not be retested provided that:		—
	- the severity specified in the component standard is not less than the severity specified in 30.2, and		N/A
	- the test report for the component states whether it complied with the standard for the relevant component with or without flame, flames not exceeding 2 s during the test are ignored		N/A
	Unless components have been previously tested and found to comply with the relevant standard for the number of cycles specified, they are tested in accordance with 24.1.1 to 24.1.9		N/A
	For components mentioned in 24.1.1 to 24.1.9, no additional tests specified in the relevant standard for the component are necessary other than those specified in 24.1.1 to 24.1.9		P
	Components that have not been separately tested and found to comply with the relevant standard, and		P
	components that are not marked or not used in accordance with their marking,		P
	are tested in accordance with the conditions occurring in the appliance, the number of samples being that required by the relevant standard		P

IEC60335_2_40J - ATTACHMENT			
Clause	Requirement - Test	Result - Remark	Verdict
	Lamp holders and starter holders that have not been previously tested and found to comply with the relevant standard are tested as a part of the appliance and additionally comply with the gauging and interchangeability requirements of the relevant standard under the conditions occurring in the appliance		N/A
	Where the relevant standard specifies these gauging and interchangeability requirements at elevated temperatures, the temperatures measured during the tests of clause 11 are used		P
	Plugs and socket-outlets and other connecting devices of interconnection cords are not interchangeable with plugs and socket-outlets listed in IEC/TR 60083 or IEC 60906-1, or		P
	with connectors and appliance inlets complying with the standard sheets of IEC 60320-1,		N/A
	if direct supply to these parts from the supply mains gives rise to a hazard		N/A
24.1.7	If the remote operation of the appliance is via a telecommunication network, the relevant standard for the telecommunication interface circuitry in the appliance is EN 41003		N/A
	Compliance with clause 8 of this standard is not impaired by connecting the appliance to a device covered by EN 41003		N/A
24.Z1	For motor running capacitors (IEC 60252-1 type P2) with a metallic enclosure having an overpressure fuse the flame testing of internal plastic parts supporting current carrying connections as required in 30.2.2 and 30.2.3.1 is not necessary		N/A
25.6	Supply cords of single-phase portable appliances having a rated current not exceeding 16 A, fitted with a plug complying with the following standard sheets of IEC/TR 60083:		—
	- for class I appliances: standard sheet C2b, C3b or C4 .....		N/A
	- for class II appliances: standard sheet C5 or C6 .....		N/A
25.7	Rubber sheathed cords (60245 IEC 53) are not suitable for appliances intended to be used outdoors or when they are liable to be exposed to significant amount of ultraviolet radiation		N/A
	Halogen-free thermoplastic compound sheathed supply cords have properties at least those of:		—

IEC60335_2_40J - ATTACHMENT			
Clause	Requirement - Test	Result - Remark	Verdict
	- halogen-free thermoplastic compound sheathed cords (H03Z1Z1H2-F or H03Z1Z1-F), for appliances having a mass not exceeding 3 kg		N/A
	- halogen-free thermoplastic compound sheathed cords (H05Z1Z1H2-F or H05Z1Z1-F), for other appliances		N/A
	Cross-linked halogen-free compound sheathed supply cords have properties at least those of cross-linked halogen-free compound sheathed cords (H07ZZ-F)		N/A
26.11	Conductors connected by soldering are not considered to be positioned or fixed so that reliance is not placed upon the soldering alone to maintain them in position unless they are held in place near the terminals independently of the solder		P
29.3.Z1	Appliance constructed so that if there is a possibility of damaging the insulation during installation, the insulation withstands the scratch and penetration test of 21.2		P
32	Compliance regarding electromagnetic fields is checked according to EN 62233		P
GG.2	Requirements for charge limits in unventilated areas (EN 60335-2-40/A1)		N/A
GG.Z1	Non-fixed factory sealed single package units with a charge amount of $m_1 < M \leq 2 \times m_1$ (EN 60335-2-40/A1)		N/A
Annex I, 19.1.101	The appliance is supplied at rated voltage and operated under normal operation with each of the fault conditions specified		N/A
	The duration of the test is as specified in 19.7		N/A

<b>ZA</b>	<b>ANNEX ZA (NORMATIVE) SPECIAL NATIONAL CONDITIONS</b>		—
	<b>Norway</b>		—
19.5	The test is also applicable to appliances intended to be permanently connected to fixed wiring		Not check
	<b>Norway</b>		—
22.2	The second paragraph of this subclause, dealing with single-phase, permanently connected class I appliances having heating elements, is not applicable due to the supply system		Not check
	<b>All CENELEC countries</b>		—

IEC60335_2_40J - ATTACHMENT			
Clause	Requirement - Test	Result - Remark	Verdict
25.6 and 25.25	Information concerning National plug and socket-outlets is available from the CENELEC website. Normative national requirements concerning plug and socket-outlets are shown in the relevant National standard		P
	<b>Ireland and United Kingdom</b>		—
25.8	In the table, the lines for 10 A and 16 A are replaced by:		—
	> 10 and ≤ 13 1,25 (1,0) <sup>b</sup> (EN 60335-1:2012/AC:2014)		Not check
	> 13 and ≤ 16 1,5 (1,0) <sup>b</sup> (EN 60335-1:2012/AC:2014)		Not check
<b>ZB</b>	<b>ANNEX ZB (INFORMATIVE) A-DEVIATIONS</b>		—
	<b>Ireland</b>		—
25.6	These regulations apply to all plugs for domestic use at a voltage of not less than 200 V and in general allow only plugs complying with I.S. 401:1997, or equivalent, to be fitted to domestic appliances		Not check
	<b>United Kingdom</b>		—
25.6	These regulations apply to all plugs for domestic use at a voltage of not less than 200 V and in general allow only plugs to BS 1363 to be fitted to domestic appliances. It also allows plugs to BS 4573 and EN 50075 to be fitted to shavers and toothbrushes		Not check
<b>ZC</b>	<b>ANNEX ZC (NORMATIVE) NORMATIVE REFERENCES TO INTERNATIONAL PUBLICATIONS WITH THEIR CORRESPONDING EUROPEAN PUBLICATIONS</b>		—
	A list of referenced documents in this standard		P
<b>ZD</b>	<b>ANNEX ZD (INFORMATIVE) IEC and CENELEC CODE DESIGNATIONS FOR FLEXIBLE CORDS</b>		—
	A table with IEC and CENELEC code designations for flexible cords		P
<b>ZE</b>	<b>ANNEX ZE (NORMATIVE) SPECIFIC ADDITIONAL REQUIREMENTS FOR APPLIANCES AND MACHINES INTENDED FOR COMMERCIAL USE</b>		—
7.1	Business name and full address of the manufacturer and, where applicable, his authorized representative.....:		N/A
	Model or type reference .....		N/A
	Serial number, if any .....		N/A
	Production year		N/A

IEC60335_2_40J - ATTACHMENT			
Clause	Requirement - Test	Result - Remark	Verdict
	Designation of the appliance .....		N/A
7.12	Instructions provided with the appliance so that the appliance can be used safely		N/A
	The instructions contain at least the following information:		—
	- the business name and full address of the manufacturer and, where applicable, his authorized representative		N/A
	- model or type reference of the appliance as marked on the appliance itself, except for the serial number		N/A
	- the designation of the appliance together with its explanation in case it is given by a combination of letters and/or numbers		N/A
	- the general description of the appliance, when needed due to the complexity of the appliance		N/A
	- specific precautions if required during installation, operation, adjusting, user maintenance, cleaning, repairing or moving		N/A
	- when needed drawings, diagrams, descriptions and explanations necessary for the safe use and user maintenance of the appliance		N/A
	- the possible reasonably foreseeable misuse and, whenever relevant, a warning against the effects it may have on the safe use of the appliance		N/A
	The words "Original instructions" appear on the language version(s) verified by the manufacturer or by the authorized representative		N/A
	When a translation of the original instructions has been provided by a person introducing the appliance on the market; the meaning of the sentence "Translation of the original instructions" appear in the relevant instructions delivered with the appliance		N/A
	The instructions for maintenance/service to be done by specialized personnel, mandated by the manufacturer or the authorized representative may be supplied in only one Community language which the specialized personnel understand		N/A
	The instructions indicate the type and frequency of inspections and maintenance required for safe operation including the preventive maintenance measures		N/A

IEC60335_2_40J - ATTACHMENT			
Clause	Requirement - Test	Result - Remark	Verdict
	"This appliance is intended to be used by expert or trained users in shops, in light industry and on farms, or for commercial use by lay persons". (EN 60335-2-40/A13)		N/A
7.12.ZE1	If needed for specific appliances, the following information to be given:		—
	- on use, transportation, assembly, dismantling when out of service, testing or foreseeable breakdowns, if these operations have consequences on stability of the appliance in order to avoid overturning, falling or uncontrolled movements of the appliance or of its component parts		N/A
	- on how to maintain adequate mechanical stability when in use, during transportation, assembly, dismantling, scrapping and any other action involving the appliance		N/A
	- on the protective measures to be taken by the user, including, where appropriate, the personal protective equipment to be provided		N/A
	- on the operating method to be followed in the event of accident or breakdown; if a blockage is likely to occur the operating method to safely unblock the appliance		N/A
	- on the specifications on the spare parts to be used, when these affect the health and safety of the operator		N/A
	- on airborne noise emissions, determined and declared in accordance with the Annex ZAB, which includes: (EN 60335-2-40/A13)		—
	- the A-weighted emission sound pressure level at workstations, where this exceeds 70 dB(A) .....; (EN 60335-2-40/A13)		N/A
	- where this level does not exceed 70 dB(A), no value needs to be given, but the instructions shall state that the A-weighted sound pressure level is below 70 dB. (EN 60335-2-40/A13)		N/A
	- the peak C-weighted instantaneous sound pressure value at workstations, where this exceeds 63 Pa (130 dB in relation to 20 µPa) :		N/A
	- the A-weighted sound power level emitted by the machinery, where the A-weighted emission sound pressure level at workstations exceeds 80 dB(A) .....		N/A

IEC60335_2_40J - ATTACHMENT			
Clause	Requirement - Test	Result - Remark	Verdict
7.12.ZE2	The instructions includes a warning to disconnect the appliance from its power source during service and when replacing parts		N/A
	If the removal of the plug is foreseen, it is clearly indicated that the removal of the plug has to be such that an operator can check from any of the points to which he has access that the plug remains removed		N/A
	If this is not possible, due to the construction of the appliance or its installation, a disconnection with a locking system in the isolated position is provided		N/A
19.11.4.8	The appliance continues to operate, without causing any hazard to the user, from the same point in its operating cycle at which the voltage fluctuation occurred, or		N/A
	a manual operation is required to restart it		N/A
20.1	Appliances and their components and fittings have adequate mechanical stability during transportation, assembly, dismantling and any other action involving the appliance		N/A
20.2	Dangerous moving transmission parts safeguarded either by design or guards		N/A
	When guards are used, they are fixed guards, interlocking movable guards or protective devices		N/A
	Moving parts directly involved in the function of the appliance which cannot be made completely inaccessible fitted with:		—
	- fixed guards or interlocking movable guards preventing access to those sections of the parts that are not used in the work, and		N/A
	- adjustable guards restricting access to those sections of the moving parts where access is necessary		N/A
	Interlocking movable guards used where frequent access is required		N/A
21.1	Appliances and their components and fittings have adequate mechanical strength and is constructed to withstand such rough handling that may be expected in normal use, during transportation, assembly, dismantling, scrapping and any other action involving the appliance		N/A
22.ZE.1	For appliances provided with a seat, the seat gives adequate stability		N/A
	The distance between the seat and the control devices capable of being adapted to the operator		N/A

IEC60335_2_40J - ATTACHMENT			
Clause	Requirement - Test	Result - Remark	Verdict
22.ZE.2	For appliances provided with separate devices for the start and the stop functions, the stop function is unambiguously identifiable and does always override the start function		N/A
	For appliances provided with one device performing the start and the stop function, the stop function is unambiguously identifiable and does always override the start function		N/A
22.ZE.3	Appliances designed in such a way that incorrect mounting is avoided, if this can lead to an unsafe situation		N/A
	If this is not possible, information on the correct mounting is given directly on the part and/or the enclosure		N/A
22.ZE.4	Where the weight, size or shape prevents appliances from being moved manually, they are fitted with attachments for lifting gear, or		N/A
	so designed that they can be fitted with such attachments, or		N/A
	be shaped in such a way that standard lifting gear can easily be used		N/A
	Appliances to be moved manually are constructed or equipped so that they can be moved easily and safely		N/A
22.ZE.5	The fixing systems of fixed guards which prevent access to dangerous moving transmission parts only removable with the use of tools		N/A
	If such guards have to be removed by the user for routine cleaning or maintenance their fixing systems remain attached to the fixed guards or to the machine after removal		N/A
	Where possible, guards are incapable of remaining in place without their fixings		N/A
	This does not apply if, after removal of the screws, or if the component is incorrectly repositioned, the appliance becomes inoperative		N/A
	Movable guards are interlocked		N/A
	The interlocking devices prevent the start of hazardous appliance functions until the guards are fixed in their position, and give a stop command whenever they are no longer closed		N/A
	Where it is possible for an operator to reach the danger zone before the risk due to hazardous appliance functions has ceased, movable guards associated with a guard locking device in addition to an interlocking device that:		—

IEC60335_2_40J - ATTACHMENT			
Clause	Requirement - Test	Result - Remark	Verdict
	- prevents the start of hazardous appliance functions until the guard is closed and locked, and		N/A
	- keeps the guard closed and locked until the risk of injury from the hazardous appliance functions has ceased		N/A
	Interlocking movable guards remain attached to the appliance when open, and		N/A
	they are designed and constructed in such a way that they can be adjusted only by means of an intentional action		N/A
22.ZE.6	Interlocking movable guards designed in such a way that the absence or failure of one of their components prevents starting or stops the hazardous appliance functions		N/A
	The guard is opened at the extent needed to cause the interlocking to operate and is then closed. This operation is carried out for 5 000 cycles at a rate of 5 cycles per min. (EN 60335-2-40/A13/AC)		N/A
	After this test any defect that may be expected in normal use is applied to the interlock system, including interruption of the supply, only one defect being simulated at a time		N/A
	After these tests the interlock system is fit for further use		N/A
22.ZE.7	Adjustable guards restricting access to areas of the moving parts strictly necessary for the work are:		—
	- adjustable manually or automatically, depending on the type of work involved, and		N/A
	- readily adjustable without the use of tools		N/A
22.ZE.8	In case of interruption, re-establishment after an interruption or fluctuation in whatever manner of the power supply, the appliance does not restart		N/A
	However, automatic restarting of the operation is allowed if the appliance may continue to operate, without causing any hazard to the user, from the same point in its operating cycle at which the voltage interruption or fluctuation occurred		N/A
22.ZE.9	Appliances fitted with means to isolate them from all energy sources		N/A
	Such isolators are clearly identified, and		N/A
	they are capable of being locked if reconnection endanger persons		N/A

IEC60335_2_40J - ATTACHMENT			
Clause	Requirement - Test	Result - Remark	Verdict
	After the energy source is disconnected, it is possible to dissipate any energy remaining or stored in the circuits of the appliance without risk to persons		N/A
<b>ZF</b>	<b>ANNEX ZF (INFORMATIVE) CRITERIA APPLIED FOR THE ALLOCATION OF PRODUCTS COVERED BY STANDARDS IN THE EN 60335 SERIES UNDER LVD OR MD</b>		—
	List of standards under CENELEC/TC61 with the allocation under the LVD (Low Voltage Directive) or the MD (Machinery Directive).....:	LVD	P
<b>ZG</b>	<b>ANNEX ZG (NORMATIVE) UV APPLIANCES</b>		—
	The following modifications to this standard apply to appliances having UV emitters		N/A
	This annex is not applicable to appliances covered by the scopes of IEC 60335-2-27, IEC 60335-2-59 or IEC 60335-2-109		N/A
7.12.ZG	The instructions for appliances incorporating UVC emitters include the substance of the following: WARNING — This appliance contains a UV emitter. Do not stare at the light source		N/A
32	For appliances incorporating UV emitters the manufacturer delivers a declaration providing evidence that the plastic material exposed to the radiation is UV resistant		N/A
<b>ZZ</b>	<b>ANNEX ZZ (INFORMATIVE) COVERAGE OF ESSENTIAL REQUIREMENTS OF EC DIRECTIVES</b>		—
	Description of the relation between this European standard and the LVD (Low Voltage Directive, 2006/95/EC) and the MD (Machinery Directive, 2006/42/EC)		P
<b>ZAA</b>	<b>ANNEX ZAA (INFORMATIVE) (EN 60335-2-40/A11) THE RELEVANCE OF THE PRESSURE EQUIPMENT DIRECTIVE</b>		—
	Refrigerating systems having a pressure greater than 0,05 MPa are considered to be assemblies falling within the scope of the Pressure Equipment Directive, 97/23/EC. However, according to Article 1, item 3.6 of the directive, equipment classified no higher than category I and covered by the low voltage directive is excluded from its scope. (EN 60335-2-40/A11)		P

IEC60335_2_40J - ATTACHMENT			
Clause	Requirement - Test	Result - Remark	Verdict
	According to guideline 1/39 of the directive, this exclusion applies to both components and assemblies (refrigerant circuits). This applies to appliances containing vessels (e.g. compressors, receivers) or piping with limits in accordance with the following (EN 60335-2-40/A11):		P
	Vessels (EN 60335-2-40/A11)		—
	- dangerous refrigerants (Annex II, Table 1) (EN 60335-2-40/A11):		—
	- volume not exceeding 1 l, or (EN 60335-2-40/A11)		P
	- pressure x volume not exceeding 5 MPa l (EN 60335-2-40/A11)		N/A
	- non-dangerous refrigerants (Annex II, Table 2) (EN 60335-2-40/A11):		—
	- volume not exceeding 1 l, or (EN 60335-2-40/A11)		N/A
	- pressure x volume not exceeding 20 MPa l (EN 60335-2-40/A11)		N/A
	Piping (EN 60335-2-40/A11)		—
	- dangerous refrigerants (Annex II, Table 6) (EN 60335-2-40/A11):		—
	- numerical designation not exceeding 25, or (EN 60335-2-40/A11)		P
	- pressure not exceeding 1 MPa and numerical designation not exceeding 100, or (EN 60335-2-40/A11)		N/A
	- pressure exceeding 1 MPa and pressure x numerical designation not exceeding 100 MPa (EN 60335-2-40/A11).		N/A
	- non-dangerous refrigerants (Annex II, Table 7) (EN 60335-2-40/A11):		—
	- numerical designation not exceeding 100, or (EN 60335-2-40/A11)		N/A
	- pressure x numerical designation not exceeding 350 MPa (EN 60335-2-40/A11).		N/A
	For other components, the most onerous limit of the two applies (EN 60335-2-40/A11)		P
	The volume is the internal volume of the vessel and includes the volume of pipework up to the first connection. It excludes the volume of fixed internal parts (EN 60335-2-40/A11)		P
	The pressure is the maximum pressure the vessel or piping system is exposed to, as specified by the manufacturer of the appliance (EN 60335-2-40/A11)		P

IEC60335_2_40J - ATTACHMENT			
Clause	Requirement - Test	Result - Remark	Verdict
	The numerical designation designates the size common to all components in the piping system (EN 60335-2-40/A11)		P
	If any component exceeds the limits given above, the appliance has to comply with the directive. The technical requirements are given in Annex I and the conformity assessment tables and procedures in Annexes II and III of the directive (EN 60335-2-40/A11)		P
	Commonly used dangerous refrigerants, identified as Group 1 in the directive, are listed in table ZAA.1 (EN 60335-2-40/A11)		P
	Commonly used non-dangerous refrigerants, identified as Group 2 in the directive, are listed in table ZAA.2 (EN 60335-2-40/A11)		N/A
<b>ZAB</b>	<b>ANNEX ZAA (NORMATIVE) (EN 60335-2-40/A13) EMISSION OF ACOUSTICAL NOISE FROM APPLIANCES COVERED BY ANNEX ZE</b>		<b>—</b>
ZAB.1	Noise reduction is an integral part of the design process and achieved by particularly applying measures at source to control noise, see for example EN ISO 11688-1. (EN 60335-2-40/A13)		N/A
	Success of the applied noise reduction measures is assessed on the basis of the actual noise emission values in relation to other machines of the same type with comparable non-acoustical technical data. (EN 60335-2-40/A13)		N/A
ZAB.2.1	A-weighted emission sound pressure level determined in accordance with EN 11203:2009, 6.2.3 d) with the surface S being the measurement surface used for the sound power level determination. (EN 60335-2-40/A13)		N/A
	If the sound power level determination is based on a measurement method requiring a reverberant sound field, the surface S to define Q, shall be a parallelepiped measurement surface at a distance of 1 m from the reference box enclosing the source and assuming only one reflecting surface. (EN 60335-2-40/A13)		N/A
ZAB.2.2	A-weighted sound power level determined in accordance with EN 12102 applying a measurement method of at least grade 2. (EN 60335-2-40/A13)		N/A
	If a grade 3 measurement method used for determining the A-weighted sound power level, the reasons are explicitly mentioned (EN 60335-2-40/A13)		N/A

IEC60335_2_40J - ATTACHMENT			
Clause	Requirement - Test	Result - Remark	Verdict
ZAB.2.3	Total measurement uncertainty is depending on the standard deviation of reproducibility $\sigma_{R0}$ of the measurement method and the standard deviation $\sigma_{omc}$ representing the instability of the operating and mounting conditions. (EN 60335-2-40/A13)		N/A
	$\sigma_{R0}$ has an upper value for a grade 2 measurement method of about 1,5 dB, whereas $\sigma_{omc}$ may have values between 0,5 dB for small variations of the sound power due on the mounting and operating conditions or 4 dB for very instable sources (EN 60335-2-40/A13)		N/A
	Total measurement uncertainty for the A-weighted emission sound pressure level is of the same order as the one for the respective sound power level measurement. (EN 60335-2-40/A13)		N/A
ZAB.2.4	Information to be recorded covers all the technical requirements of this noise test code. (EN 60335-2-40/A13)		N/A
	Any deviations from this noise test code or from the basic standards upon which it is based are to be recorded together with the technical justification for such deviations. (EN 60335-2-40/A13)		N/A
ZAB.2.5	Information to be given in the test report includes : (EN 60335-2-40/A13)		N/A
	- the data required by the manufacturer for inclusion in the noise declaration. (EN 60335-2-40/A13)		N/A
	- the data required by the user to verify the declared values. (EN 60335-2-40/A13)		N/A
	Thus the following information shall be included...: (EN 60335-2-40/A13)		N/A
	- reference to the noise test code and the basic noise emission standards used; (EN 60335-2-40/A13)		N/A
	- description of the installation and operation conditions used; (EN 60335-2-40/A13)		N/A
	- location of the work station(s) and other specified positions; (EN 60335-2-40/A13)		N/A
	- the noise emission values obtained (EN 60335-2-40/A13)		N/A
	Test report states that all requirements of the noise test code have been fulfilled, or, if this is not the case, it shall identify any unfulfilled requirements. (EN 60335-2-40/A13)		N/A

IEC60335_2_40J - ATTACHMENT			
Clause	Requirement - Test	Result - Remark	Verdict
	Deviations from the requirements stated and a technical justification for these deviations shall be given. (EN 60335-2-40/A13)		N/A
ZAB.2.6	Noise emission declaration is made according to EN ISO 4871 (EN 60335-2-40/A13)		N/A
	Emission sound pressure level $L_{pA}$ is made as a dual number noise emission declaration, thus declaring the determined value for $L_{pA}$ and the respective uncertainty $K_{pA}$ . (EN 60335-2-40/A13)		N/A
	Sound power level $L_{WA}$ is declared as single number noise emission declaration declaring the sum of the measured sound power level and its uncertainty $K_{WA}$ . (EN 60335-2-40/A13)		N/A
	Noise declaration states that the noise emission values have been obtained according to this noise test code. (EN 60335-2-40/A13)		N/A
	Any deviations from this noise test code or from the basic standards upon which it is based are clearly indicated. (EN 60335-2-40/A13)		N/A
	Additional noise emission values are given in the declaration. (EN 60335-2-40/A13)		N/A
	If undertaken, verification of the noise emission values shall be conducted according to EN ISO 4871, using the same mounting and operating conditions as those used for the initial determination. (EN 60335-2-40/A13)		N/A

---End of this attachment---

## Attachment 2

Clause	Requirement - Test	Result - Remark	Verdict
--------	--------------------	-----------------	---------

<b>ATTACHMENT TO TEST REPORT IEC 60335-1</b> <b>Household and similar electrical appliances – Safety –</b> <b>Part 1: General requirements</b>	
<b>Differences according to:</b>	EN 60335-1:2012/ A11: 2014
<b>Attachment Form No.:</b>	EN 60335-1/A11
<b>Attachment Originator:</b>	SGS-CSTC
<b>Master Attachment:</b>	Date 2014-09

7.14	In NOTE Z1, replace "IEC 82079-1" by "EN 82079-1".		P
Annex ZF	In Table ZF.1 – List of standards under CLC/TC 61, replace line of EN 60335-2-38 by the following: EN 60335-2-38, Commercial electric griddles and griddle grills with moving parts		N/A

---End of the attachment---

EN 60335-1: 2012 /A13: 2017			
Clause	Requirement - Test	Result - Remark	Verdict

<b>ATTACHMENT TO TEST REPORT EN 60335-1</b> <b>Household and similar electrical appliances – Safety –</b> <b>Part 1: General requirements</b>	
<b>Differences according to .....</b>	<b>EN 60335-1: 2012 /A13: 2017</b>
<b>Attachment Form No.....</b>	EN 60335_1
<b>Attachment Originator .....</b>	SGS-CSTC
<b>Master Attachment.....</b>	Date 2018-01

Annex ZC	Replace Annex ZC of EN 60335-1:2012	P
<b>Replace Annex ZZ of EN 60335-1:2012 with Annex ZZA&amp; ZZB</b>		—
Annex ZZA	(informative) Relationship between this European standard and the safety objectives of Directive 2014/35/EU [2014 OJ L96] aimed to be covered	P
Annex ZZB	(informative) Relationship between this European standard and the essential requirements of Directive 2006/42/EC aimed to be covered	P

--End of this Attachment--

# Attachment 4 Circuit diagram documentation

Circuit diagram of indoor unit (Model A, A1, B, B1, C, C1, D, D1, F, F1, G, H)

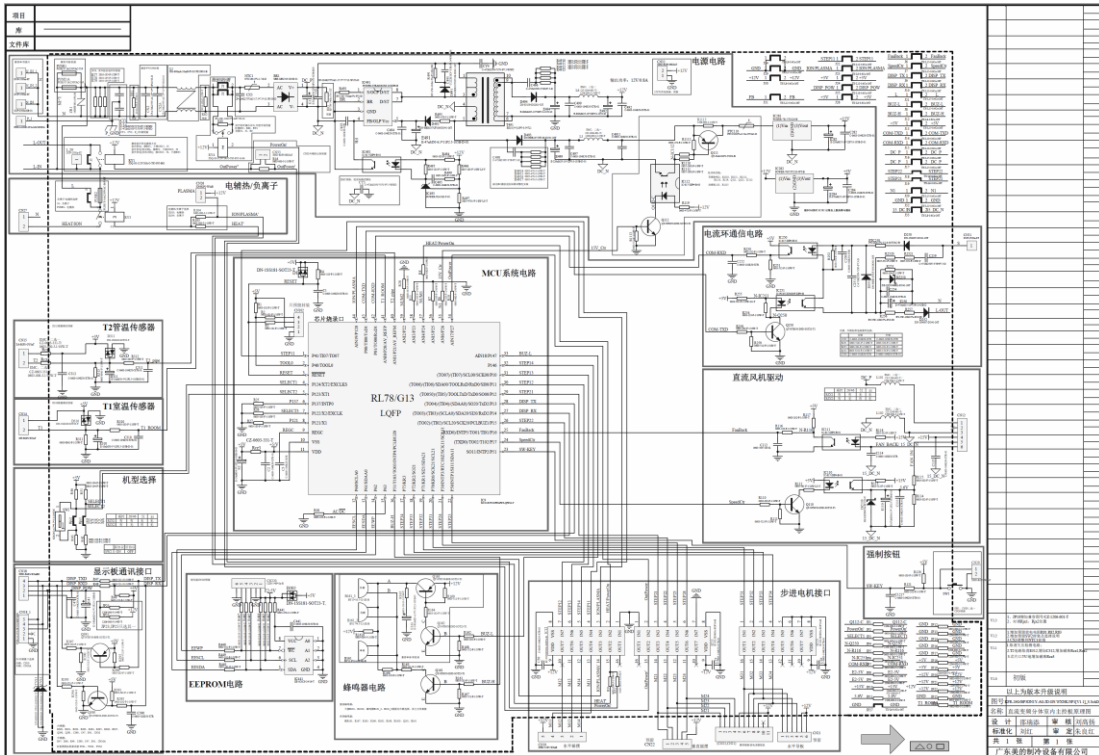

Circuit diagram of indoor unit (Model E, E1)

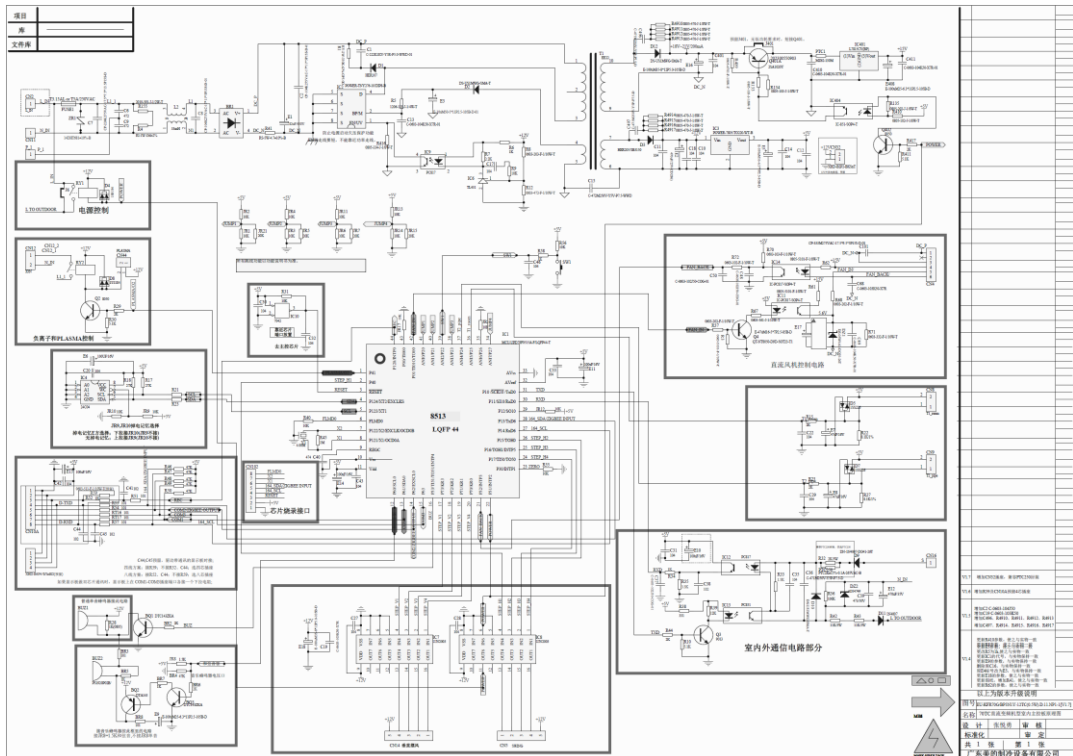

### Attachment 4 Circuit diagram documentation

Circuit diagram of outdoor unit of model A, A1, B, B1, C, C1, D, D1, F, F1, G, H

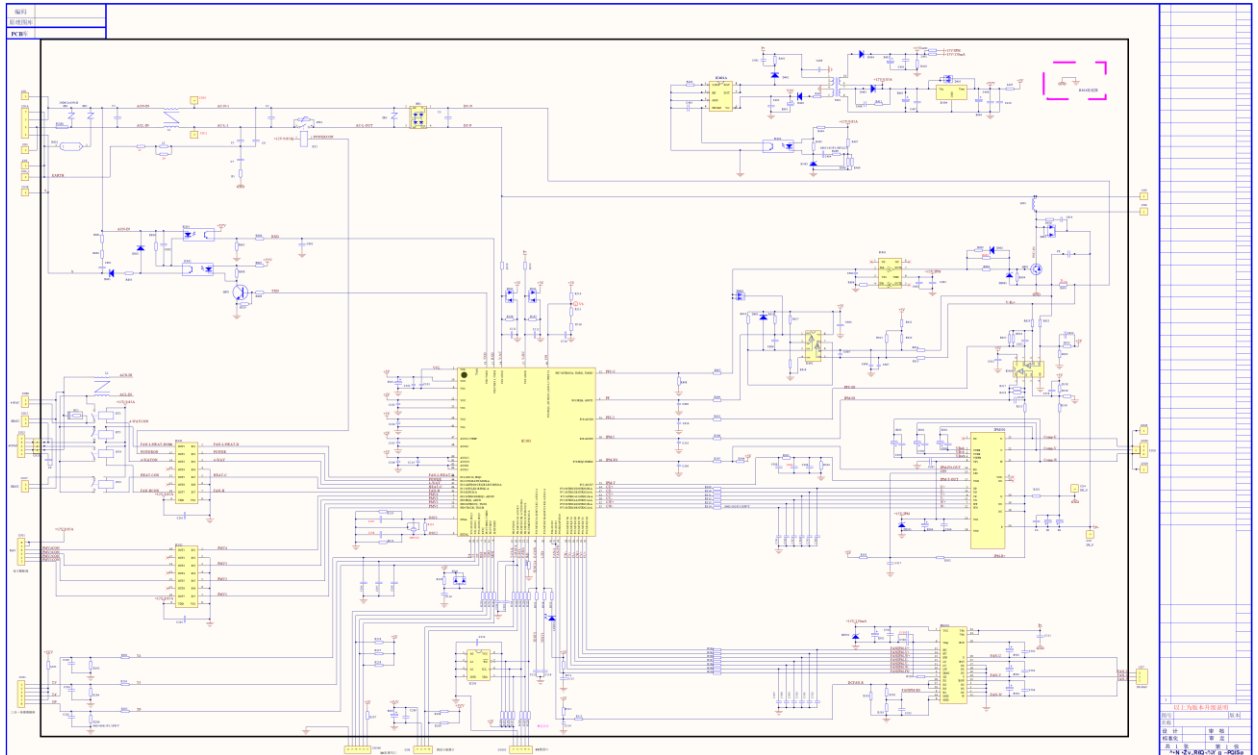

Circuit diagram of outdoor unit of model E, E1

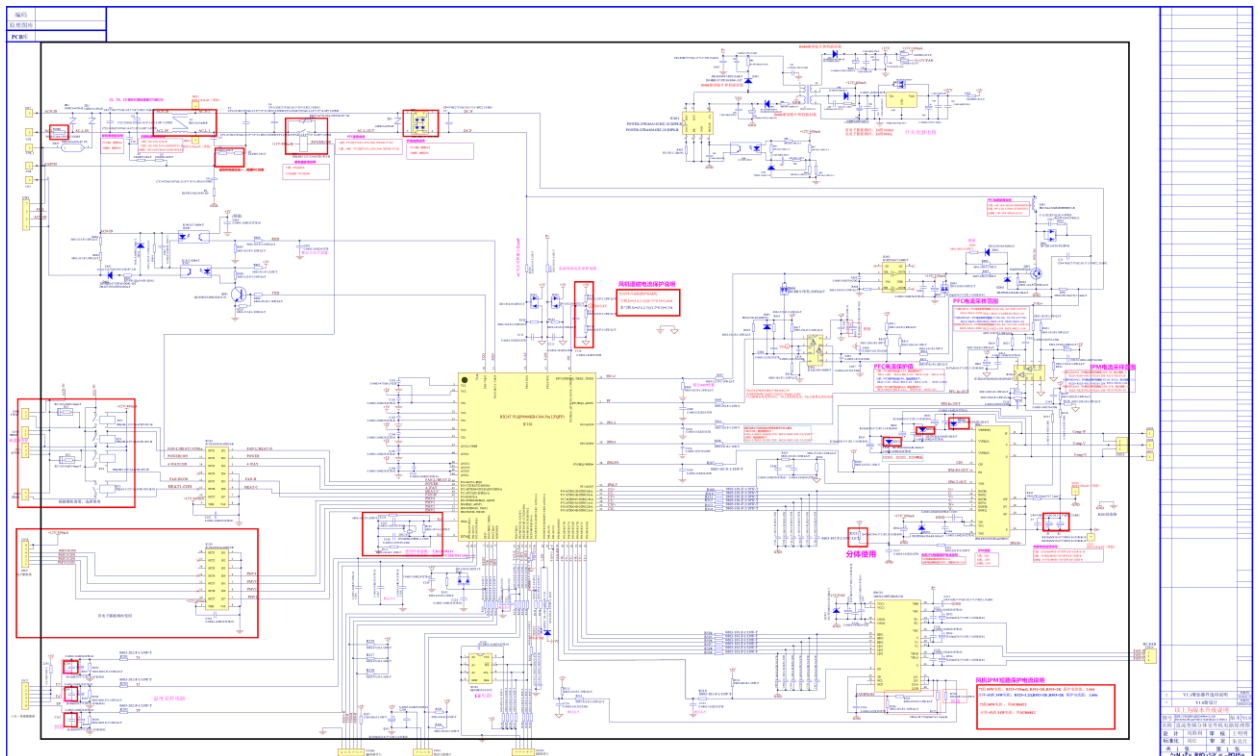

---End of Attachment 4---

### Attachment 5 photo documentation

Type of equipment, model: Split-Type Air Conditioner / See TRF

Details of: Indoor unit appearance for model A



Details of: Indoor unit appearance for model A



**Attachment 5 photo documentation**

Details of: Indoor unit appearance for model A

View:

general

front

rear

right

left

top

bottom



Details of: Indoor unit appearance for model A

View:

general

front

rear

right

left

top

bottom



### Attachment 5 photo documentation

Details of: Inner view for model A

View:

- general
- front
- rear
- right
- left
- top
- bottom



Details of: Inner view for model A

View:

- general
- front
- rear
- right
- left
- top
- bottom



**Attachment 5 photo documentation**

Details of: Inner view for model A

View:

- general
- front
- rear
- right
- left
- top
- bottom



Details of: Terminal block, earthing symbol and Cord anchorage for model A

View:

- general
- front
- rear
- right
- left
- top
- bottom

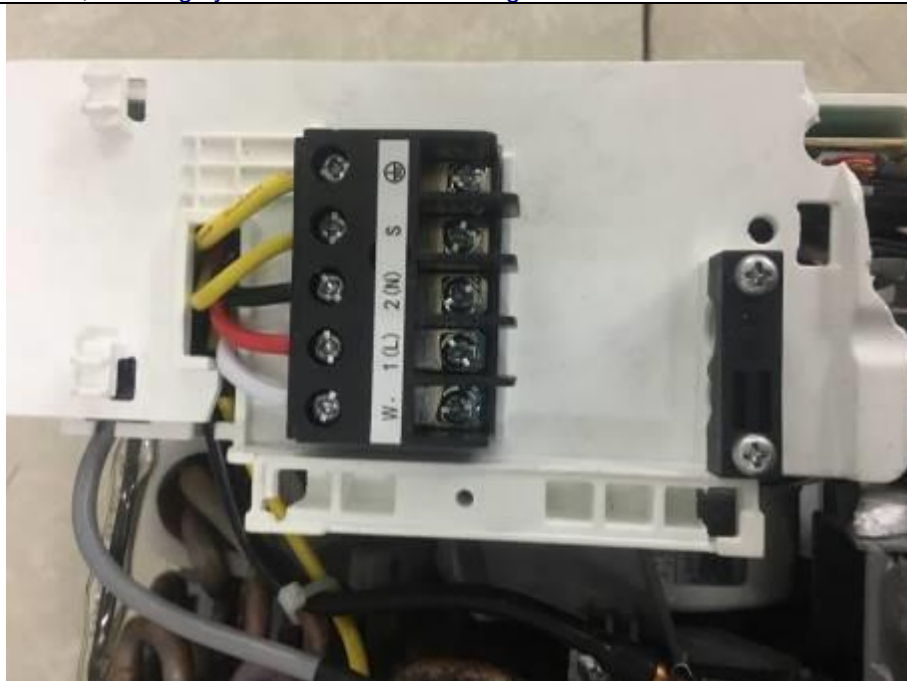

### Attachment 5 photo documentation

Details of: Fan motor for model A

View:

- general
- front
- rear
- right
- left
- top
- bottom



Details of: Main PCB for model A

View:

- general
- front
- rear
- right
- left
- top
- bottom



### Attachment 5 photo documentation

Details of: Main PCB lay-out for model A

View:

- general
- front
- rear
- right
- left
- top
- bottom



Details of: Control panel PCB for model A

View:

- general
- front
- rear
- right
- left
- top
- bottom



### Attachment 5 photo documentation

Details of: Control panel PCB lay-out for model A

View:

- general
- front
- rear
- right
- left
- top
- bottom

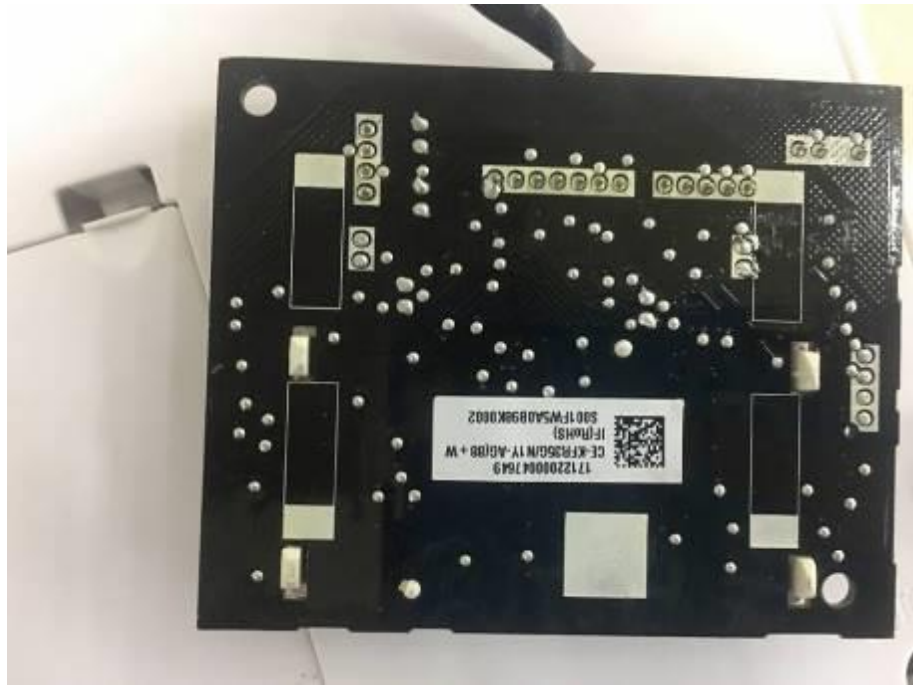

Details of: Outdoor unit appearance for model A

View:

- general
- front
- rear
- right
- left
- top
- bottom



### Attachment 5 photo documentation

Details of: Outdoor unit appearance for model A

View:

- general
- front
- rear
- right
- left
- top
- bottom



Details of: Outdoor unit appearance for model A

View:

- general
- front
- rear
- right
- left
- top
- bottom



### Attachment 5 photo documentation

Details of: Outdoor unit appearance for model A



Details of: Inner view for model A

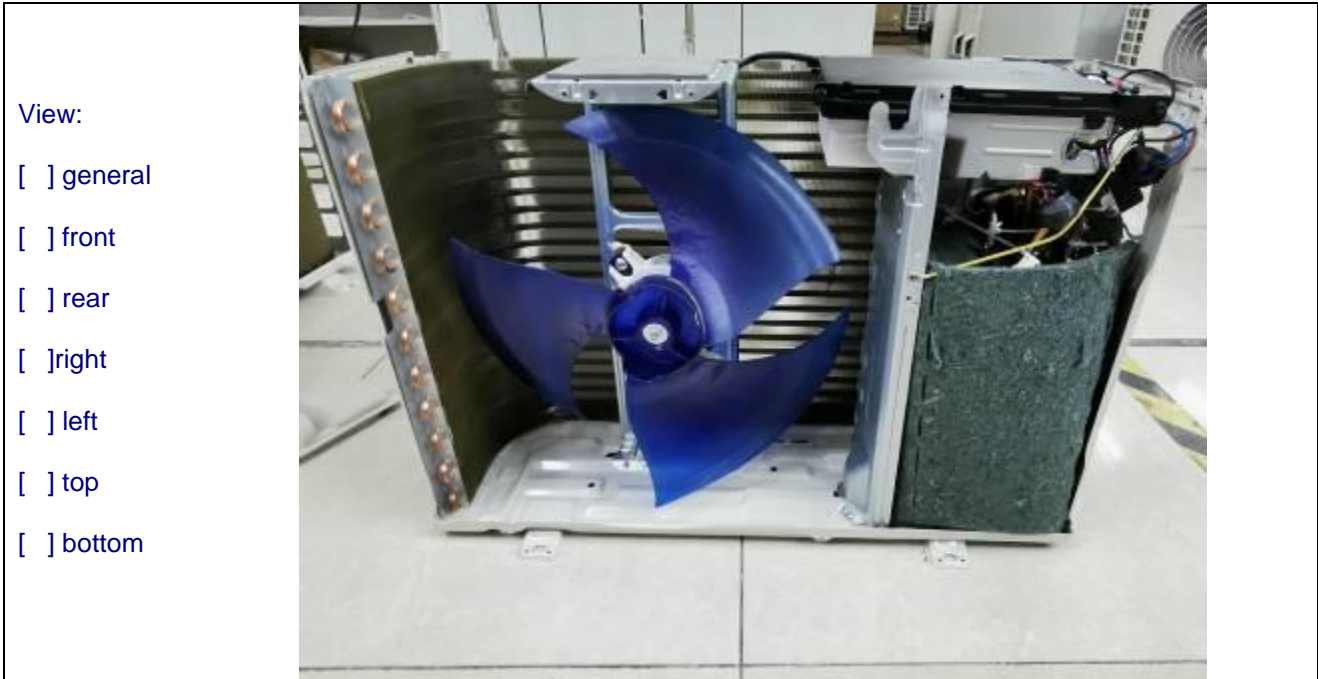

**Attachment 5 photo documentation**

Details of: Inner view for model A



Details of: Fan motor for model A



### Attachment 5 photo documentation

Details of: Terminal block, cord anchorage and earthing symbol for model A

View:

- general
- front
- rear
- right
- left
- top
- bottom



Details of: Compressor label for model A

View:

- general
- front
- rear
- right
- left
- top
- bottom



### Attachment 5 photo documentation

Details of: Main PCB for model A

View:

- general
- front
- rear
- right
- left
- top
- bottom



Details of: Main PCB layout for model A

View:

- general
- front
- rear
- right
- left
- top
- bottom

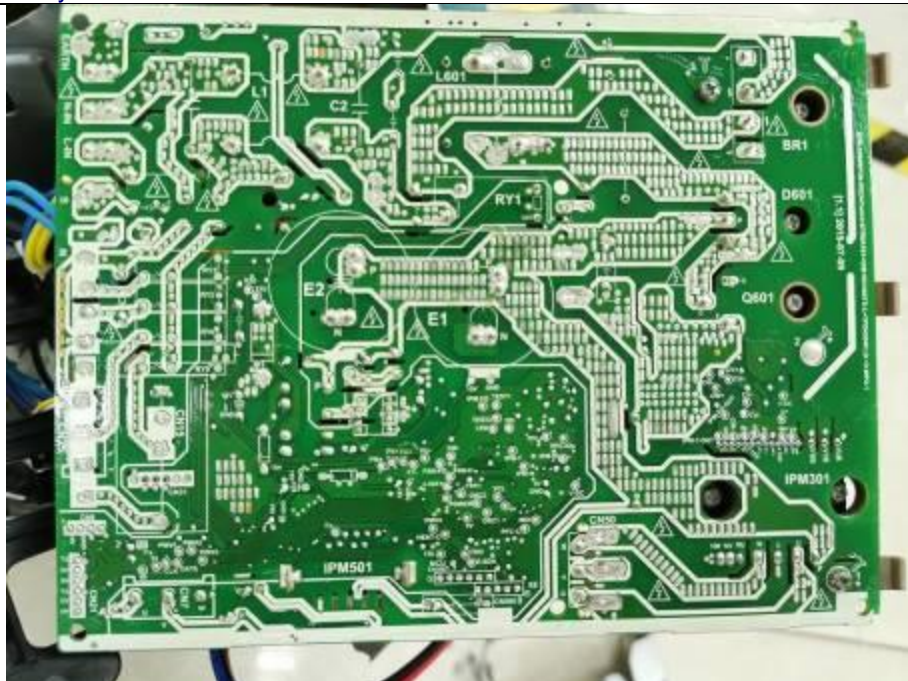

### Attachment 5 photo documentation

Details of: Indoor unit appearance for model B, F, G, H



Details of: Indoor unit appearance for model B, G, H



### Attachment 5 photo documentation

Details of: Indoor unit appearance for model B, F, G, H

View:

general

front

rear

right

left

top

bottom



Details of: Indoor unit appearance for model B, G, H

View:

general

front

rear

right

left

top

bottom



### Attachment 5 photo documentation

Details of: Inner view for model B, F, G, H

View:

general

front

rear

right

left

top

bottom



Details of: Inner view for model B, G, H

View:

general

front

rear

right

left

top

bottom



### Attachment 5 photo documentation

Details of: Inner view for model B, F, G, H

View:

- general
- front
- rear
- right
- left
- top
- bottom



Details of: Step motor and anion generator for model B

View:

- general
- front
- rear
- right
- left
- top
- bottom



### Attachment 5 photo documentation

Details of: Terminal block, earthing symbol and Cord anchorage for model B, F, G, H



Details of: Fan motor for model B, F, G, H



### Attachment 5 photo documentation

Details of: Main PCB for model B, F, G, H

View:

- general
- front
- rear
- right
- left
- top
- bottom



Details of: Main PCB lay-out for model B, F, G, H

View:

- general
- front
- rear
- right
- left
- top
- bottom



### Attachment 5 photo documentation

Details of: Control panel PCB for model B, F, G, H

View:

- general
- front
- rear
- right
- left
- top
- bottom



Details of: Control panel PCB lay-out for model B, F, G, H

View:

- general
- front
- rear
- right
- left
- top
- bottom

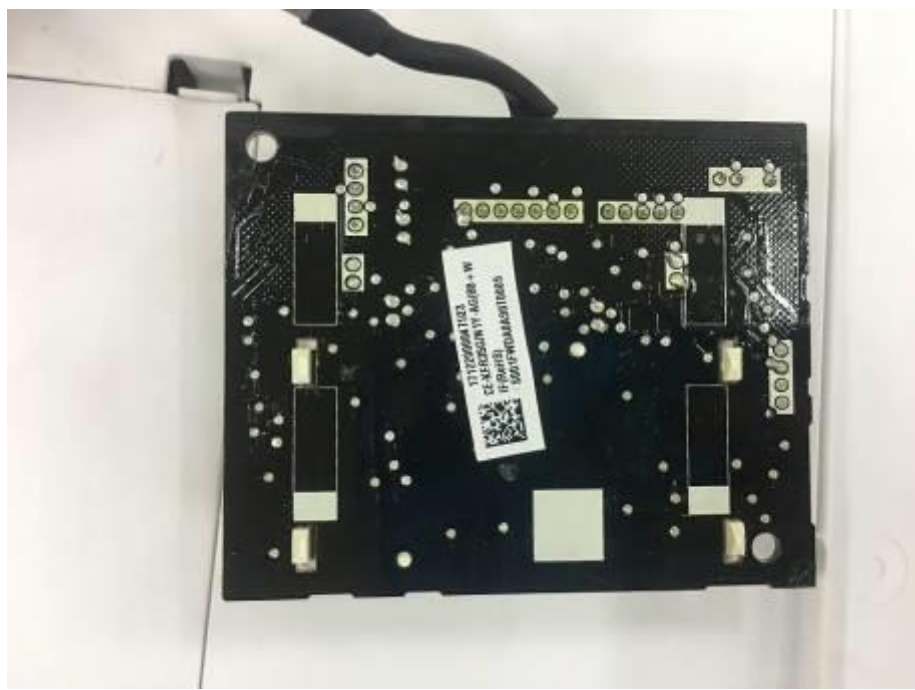

### Attachment 5 photo documentation

Details of: Outdoor unit appearance for model B, F

View:

general

front

rear

right

left

top

bottom



Details of: Outdoor unit appearance for model B, F

View:

general

front

rear

right

left

top

bottom



### Attachment 5 photo documentation

Details of: Outdoor unit appearance for model B, F

View:

general

front

rear

right

left

top

bottom



Details of: Outdoor unit appearance for model B, F

View:

general

front

rear

right

left

top

bottom



### Attachment 5 photo documentation

Details of: Inner view for model B, F

View:

general

front

rear

right

left

top

bottom

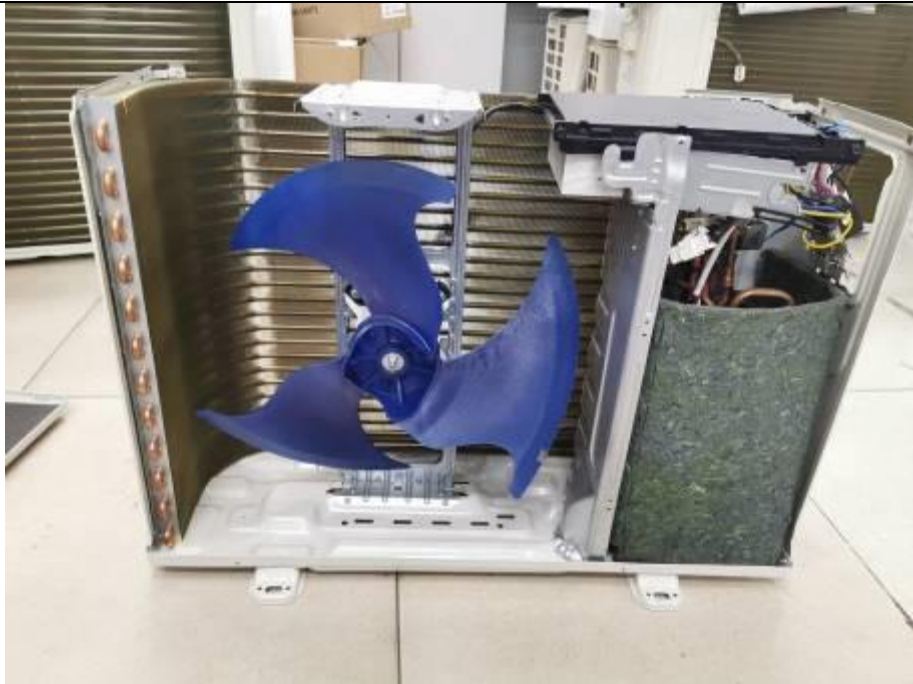

Details of: Inner view for model B, F

View:

general

front

rear

right

left

top

bottom





### Attachment 5 photo documentation

Details of: Compressor label for model B, F

View:

- general
- front
- rear
- right
- left
- top
- bottom



Details of: Main PCB for model B, F

View:

- general
- front
- rear
- right
- left
- top
- bottom



### Attachment 5 photo documentation

Details of: Main PCB layout for model B, F

View:

- general
- front
- rear
- right
- left
- top
- bottom



Details of: General view of indoor unit of model C

View:

- general
- front
- rear
- right
- left
- top
- bottom



**Attachment 5 photo documentation**

Details of: General view of indoor unit of model C

View:

- general
- front
- rear
- right
- left
- top
- bottom



Details of: General view of indoor unit of model C

View:

- general
- front
- rear
- right
- left
- top
- bottom



### Attachment 5 photo documentation

Details of: General view of indoor unit of model C

View:

- general
- front
- rear
- right
- left
- top
- bottom



Details of: Internal view of indoor unit of model C

View:

- general
- front
- rear
- right
- left
- top
- bottom



### Attachment 5 photo documentation

Details of: Internal view of indoor unit of model C

View:

- general
- front
- rear
- right
- left
- top
- bottom



Details of: Internal view of indoor unit of model C

View:

- general
- front
- rear
- right
- left
- top
- bottom



### Attachment 5 photo documentation

Details of: Indoor fan motor of model C

View:

- general
- front
- rear
- right
- left
- top
- bottom



Details of: Indoor unit main PCB of model C

View:

- general
- front
- rear
- right
- left
- top
- bottom

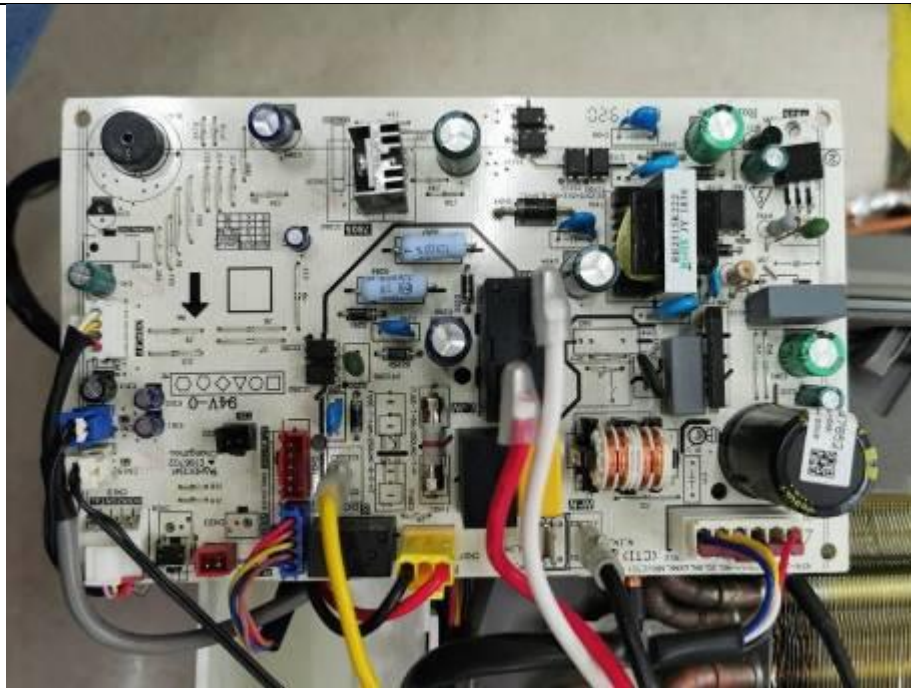

### Attachment 5 photo documentation

Details of: Indoor unit main PCB lay-out of model C

View:

- general
- front
- rear
- right
- left
- top
- bottom

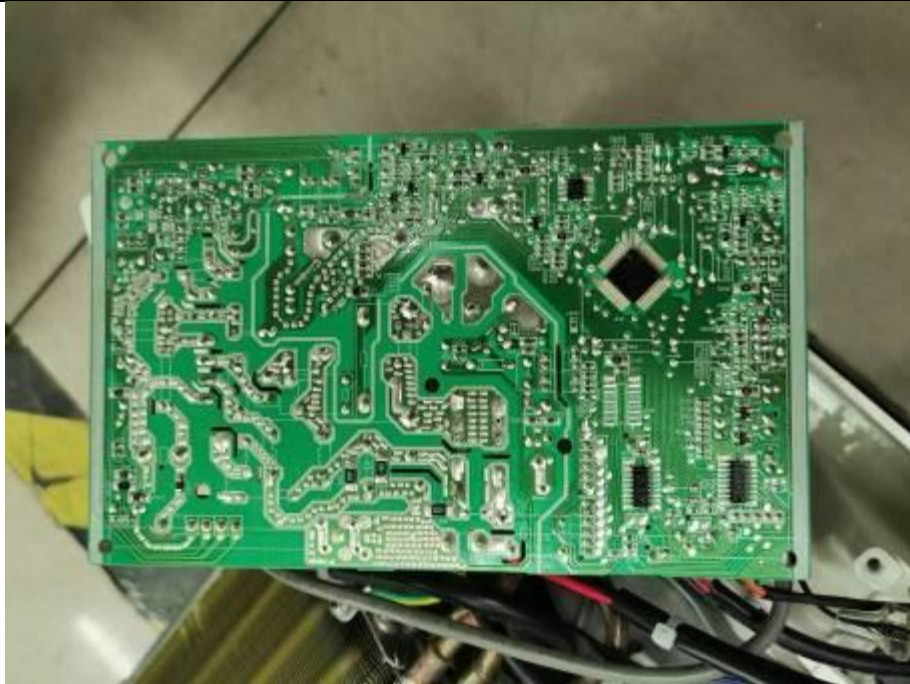

Details of: Indoor unit display PCB of model C

View:

- general
- front
- rear
- right
- left
- top
- bottom

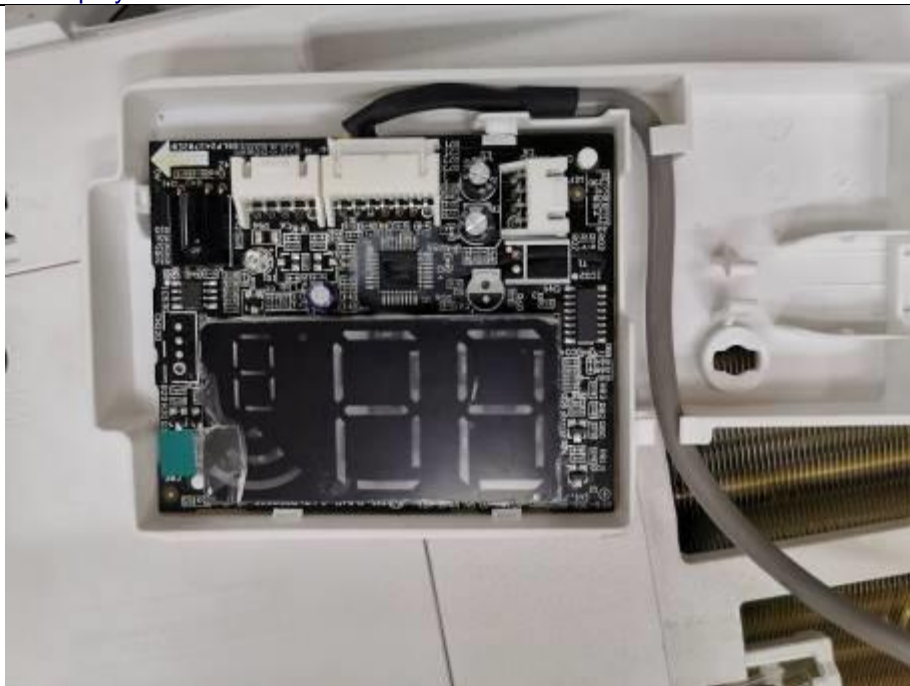

### Attachment 5 photo documentation

Details of: Indoor unit display PCB layout of model C

View:

general

front

rear

right

left

top

bottom



Details of: Step motor and anion generator of model C

View:

general

front

rear

right

left

top

bottom



### Attachment 5 photo documentation

Details of: Indoor terminal block and earthing terminal of model C

View:

- general
- front
- rear
- right
- left
- top
- bottom



Details of: General view of outdoor unit of model C

View:

- general
- front
- rear
- right
- left
- top
- bottom



### Attachment 5 photo documentation

Details of: General view of outdoor unit of model C

View:

general

front

rear

right

left

top

bottom



Details of: General view of outdoor unit of model C

View:

general

front

rear

right

left

top

bottom



### Attachment 5 photo documentation

Details of: General view of outdoor unit of model C

View:

general

front

rear

right

left

top

bottom



Details of: Internal view of outdoor unit of model C

View:

general

front

rear

right

left

top

bottom

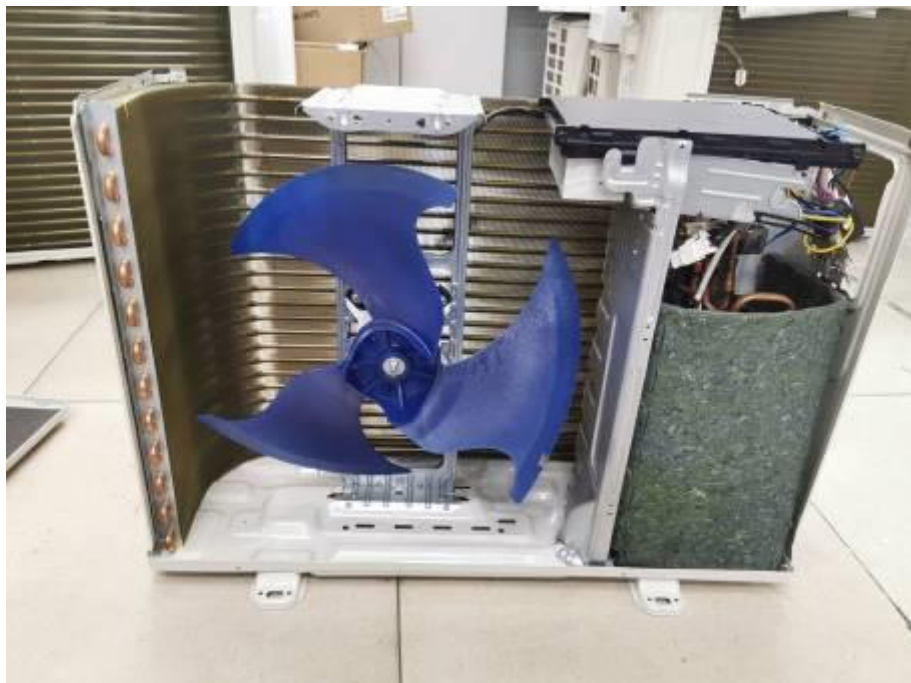

### Attachment 5 photo documentation

Details of: Internal view of outdoor unit of model C

View:

general

front

rear

right

left

top

bottom



Details of: Compressor of model C

View:

general

front

rear

right

left

top

bottom



### Attachment 5 photo documentation

Details of: Outdoor fan motor of model C

View:

general

front

rear

right

left

top

bottom



Details of: Outdoor unit main PCB of model C

View:

general

front

rear

right

left

top

bottom



### Attachment 5 photo documentation

Details of: Outdoor unit main PCB layout of model C

View:

general

front

rear

right

left

top

bottom



Details of: Outdoor unit terminal block of model C

View:

general

front

rear

right

left

top

bottom



### Attachment 5 photo documentation

Details of: General view of indoor unit of model D

View:

- general
- front
- rear
- right
- left
- top
- bottom



Details of: General view of indoor unit of model D

View:

- general
- front
- rear
- right
- left
- top
- bottom



### Attachment 5 photo documentation

Details of: General view of indoor unit of model D

View:

general

front

rear

right

left

top

bottom



Details of: General view of indoor unit of model D



### Attachment 5 photo documentation

Details of: Internal view of indoor unit of model D

View:

- general
- front
- rear
- right
- left
- top
- bottom



Details of: Internal view of indoor unit of model D

View:

- general
- front
- rear
- right
- left
- top
- bottom



**Attachment 5 photo documentation**

Details of: Internal view of indoor unit of model D

View:

- general
- front
- rear
- right
- left
- top
- bottom



Details of: Internal view of indoor unit of model D

View:

- general
- front
- rear
- right
- left
- top
- bottom



**Attachment 5 photo documentation**

Details of: Indoor fan motor of model D

View:

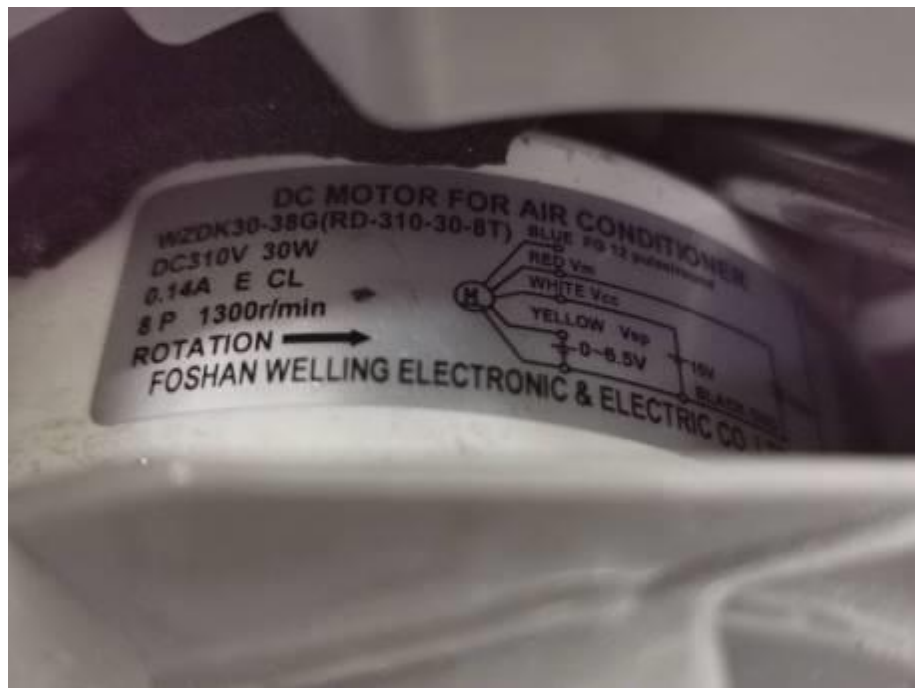
 general front rear right left top bottom

Details of: Indoor unit main PCB of model D

View:

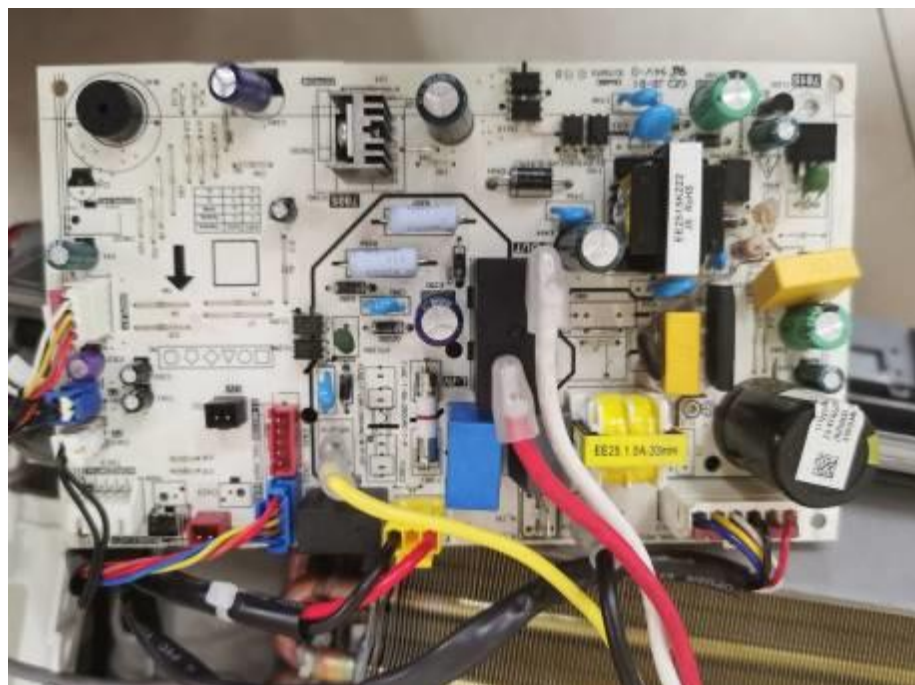
 general front rear right left top bottom

### Attachment 5 photo documentation

Details of: Indoor unit main PCB lay-out of model D

View:

general

front

rear

right

left

top

bottom



Details of: Indoor unit display PCB of model D

View:

general

front

rear

right

left

top

bottom





### Attachment 5 photo documentation

Details of: Indoor terminal block and earthing terminal of model D

View:

- general
- front
- rear
- right
- left
- top
- bottom

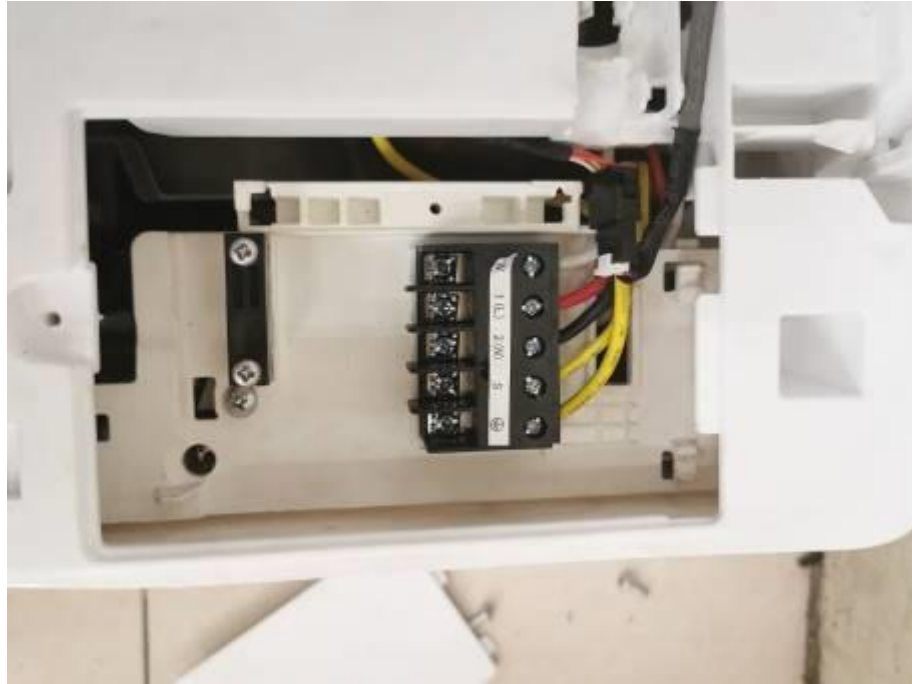

Details of: General view of outdoor unit of model D

View:

- general
- front
- rear
- right
- left
- top
- bottom



### Attachment 5 photo documentation

Details of: General view of outdoor unit of model D

View:

general

front

rear

right

left

top

bottom



Details of: General view of outdoor unit of model D

View:

general

front

rear

right

left

top

bottom



### Attachment 5 photo documentation

Details of: General view of outdoor unit of model D

View:

general

front

rear

right

left

top

bottom



Details of: Internal view of outdoor unit of model D

View:

general

front

rear

right

left

top

bottom



**Attachment 5 photo documentation**

Details of: Compressor of model D

View:

 general front rear right left top bottom

Details of: Outdoor fan motor of model D

View:

 general front rear right left top bottom

### Attachment 5 photo documentation

Details of: Outdoor unit main PCB of model D

View:

- general
- front
- rear
- right
- left
- top
- bottom



Details of: Outdoor unit main PCB layout of model D

View:

- general
- front
- rear
- right
- left
- top
- bottom



**Attachment 5 photo documentation**

Details of: Outdoor unit terminal block of model D

View:

 general front rear right left top bottom

Details of: General view of indoor unit of model E

View:

 general front rear right left top bottom

### Attachment 5 photo documentation

Details of: General view of indoor unit of model E

View:

- general
- front
- rear
- right
- left
- top
- bottom



Details of: General view of indoor unit of model E

View:

- general
- front
- rear
- right
- left
- top
- bottom



### Attachment 5 photo documentation

Details of: General view of indoor unit of model E

View:

- general
- front
- rear
- right
- left
- top
- bottom



Details of: Internal view of indoor unit of model E

View:

- general
- front
- rear
- right
- left
- top
- bottom



### Attachment 5 photo documentation

Details of: Internal view of indoor unit of model E

View:

- general
- front
- rear
- right
- left
- top
- bottom



Details of: Internal view of indoor unit of model E

View:

- general
- front
- rear
- right
- left
- top
- bottom



### Attachment 5 photo documentation

Details of: Indoor fan motor of model E

View:

- general
- front
- rear
- right
- left
- top
- bottom



Details of: Indoor unit main PCB of model E

View:

- general
- front
- rear
- right
- left
- top
- bottom



### Attachment 5 photo documentation

Details of: Indoor unit main PCB lay-out of model E

View:

general

front

rear

right

left

top

bottom

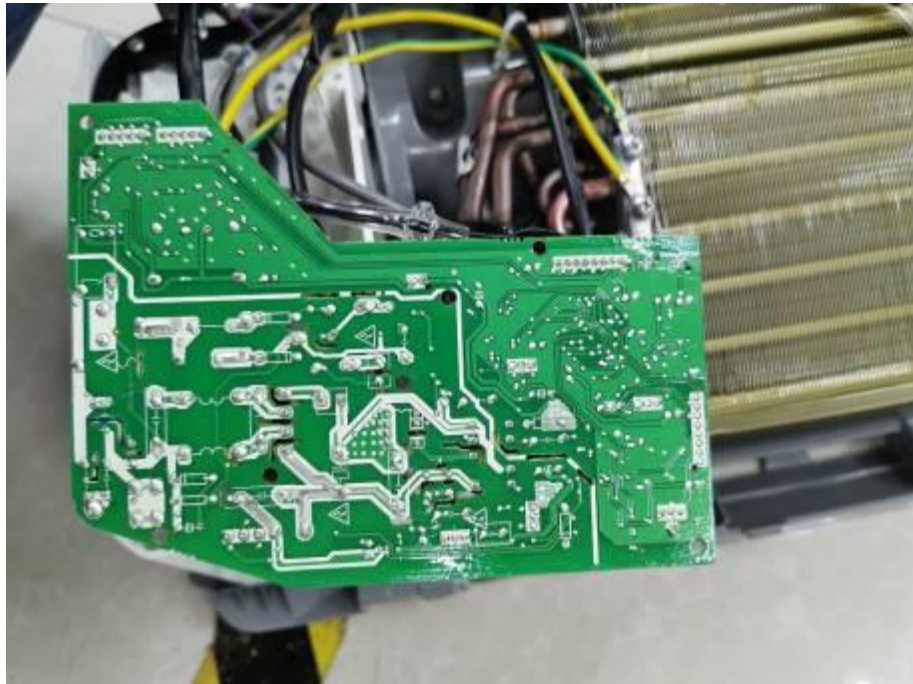

Details of: Indoor unit display PCB of model E

View:

general

front

rear

right

left

top

bottom

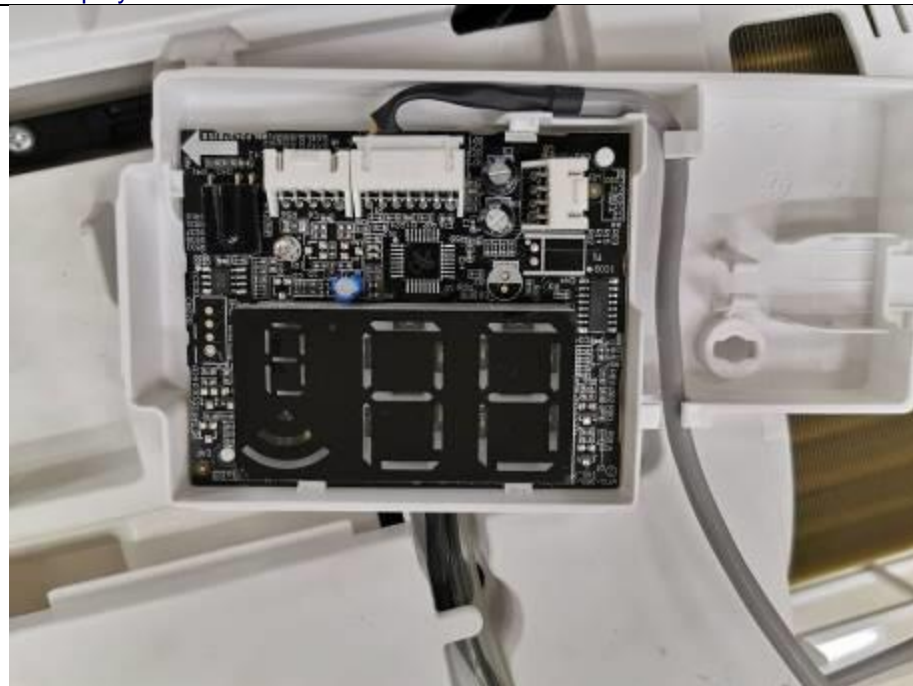



### Attachment 5 photo documentation

Details of: Indoor terminal block and earthing terminal of model E

View:

- general
- front
- rear
- right
- left
- top
- bottom

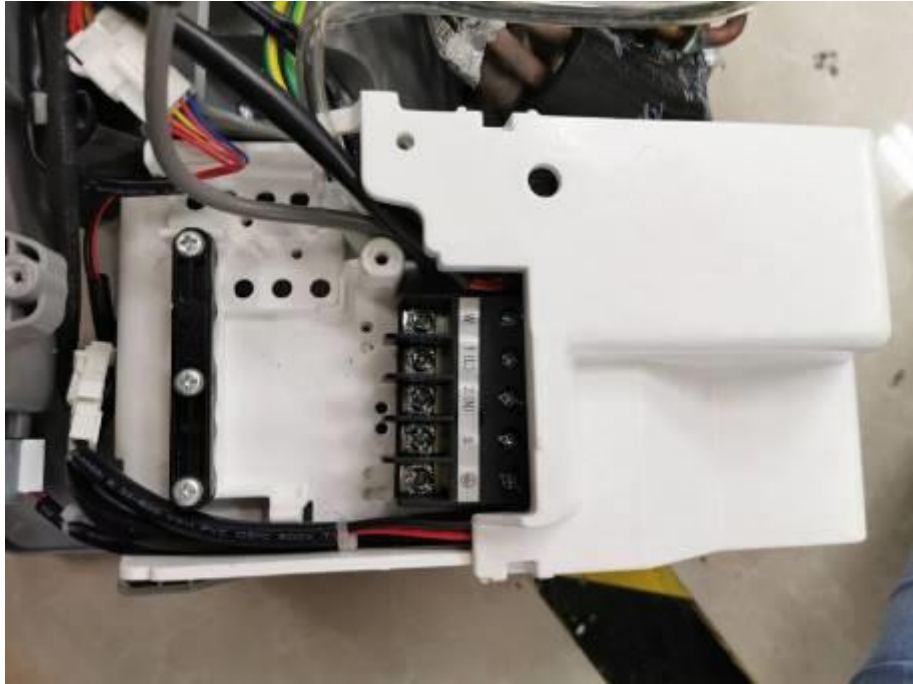

Details of: General view of outdoor unit of model E

View:

- general
- front
- rear
- right
- left
- top
- bottom



### Attachment 5 photo documentation

Details of: General view of outdoor unit of model E

View:

general

front

rear

right

left

top

bottom



Details of: General view of outdoor unit of model E

View:

general

front

rear

right

left

top

bottom



### Attachment 5 photo documentation

Details of: General view of outdoor unit of model E

View:

general

front

rear

right

left

top

bottom



Details of: Internal view of outdoor unit of model E

View:

general

front

rear

right

left

top

bottom



### Attachment 5 photo documentation

Details of: Compressor of model E

View:

general

front

rear

right

left

top

bottom



Details of: Outdoor fan motor of model E

View:

general

front

rear

right

left

top

bottom



### Attachment 5 photo documentation

Details of: Outdoor unit main PCB of model E

View:

- general
- front
- rear
- right
- left
- top
- bottom



Details of: Outdoor unit main PCB layout of model E

View:

- general
- front
- rear
- right
- left
- top
- bottom

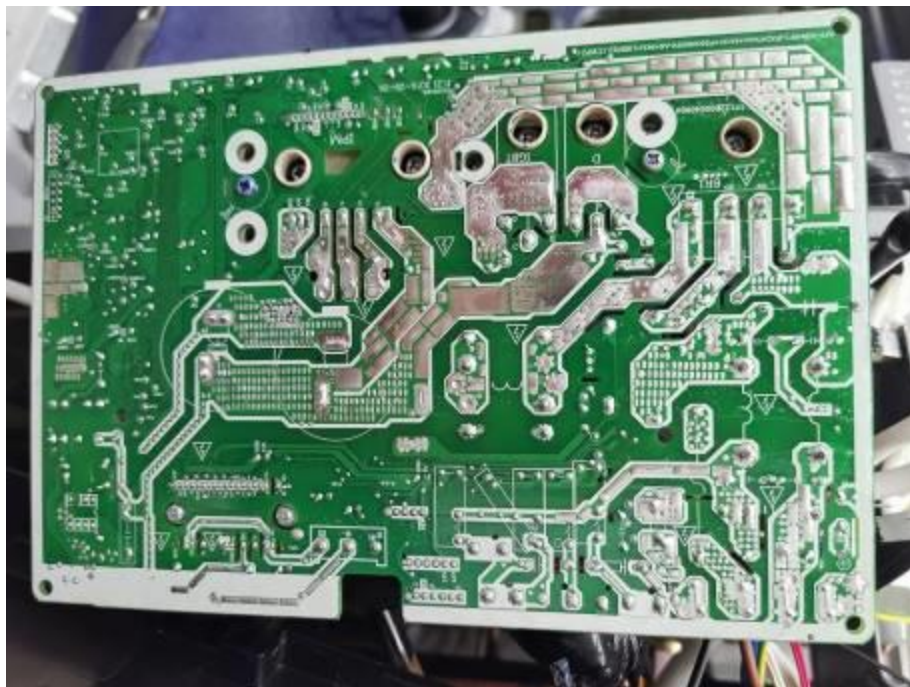

### Attachment 5 photo documentation

Details of: Outdoor unit terminal block of model E

View:

- general
- front
- rear
- right
- left
- top
- bottom



Details of: Electronic expansion valve of model F

View:

- general
- front
- rear
- right
- left
- top
- bottom



### Attachment 5 photo documentation

Details of: General view of outdoor unit of model G, H

View:

general

front

rear

right

left

top

bottom



Details of: General view of outdoor unit of model G, H

View:

general

front

rear

right

left

top

bottom



**Attachment 5 photo documentation**

Details of: General view of outdoor unit of model G, H

View:

general

front

rear

right

left

top

bottom



Details of: General view of outdoor unit of model G, H

View:

general

front

rear

right

left

top

bottom



### Attachment 5 photo documentation

Details of: Inner view of outdoor unit of model G, H

View:

general

front

rear

right

left

top

bottom



Details of: Inner view of outdoor unit of model G, H

View:

general

front

rear

right

left

top

bottom



**Attachment 5 photo documentation**

Details of: Compressor of outdoor unit of model G, H

View:

 general front rear right left top bottom

Details of: Fan motor of outdoor unit of model G, H

View:

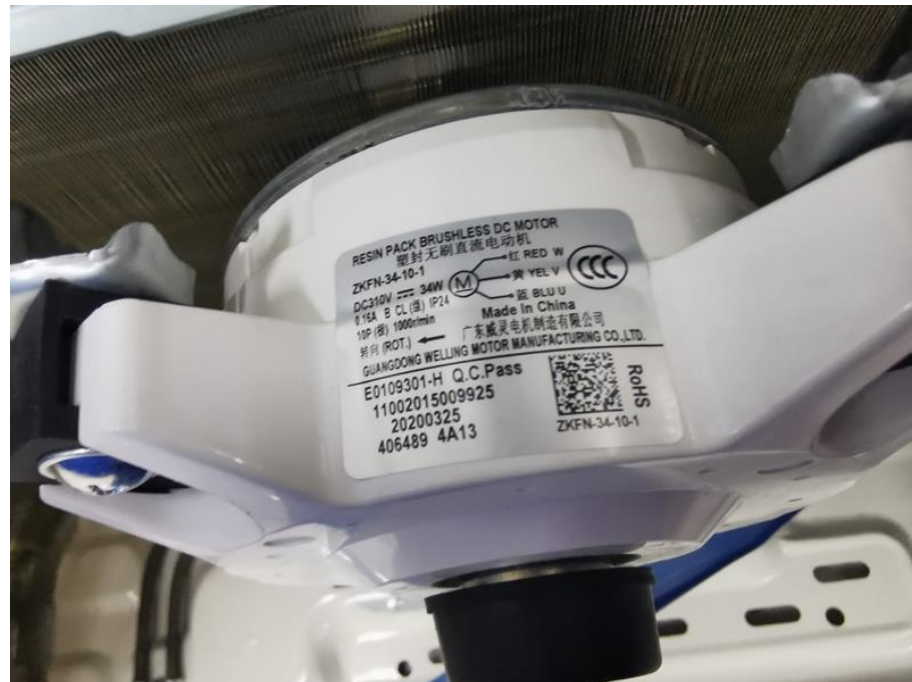
 general front rear right left top bottom

### Attachment 5 photo documentation

Details of: Terminal block of outdoor unit of model G, H

View:

general

front

rear

right

left

top

bottom



Details of: Main controller of outdoor unit of model G, H

View:

general

front

rear

right

left

top

bottom



### Attachment 5 photo documentation

Details of: Main controller PCB lay-out of outdoor unit of model G, H

View:

general

front

rear

right

left

top

bottom

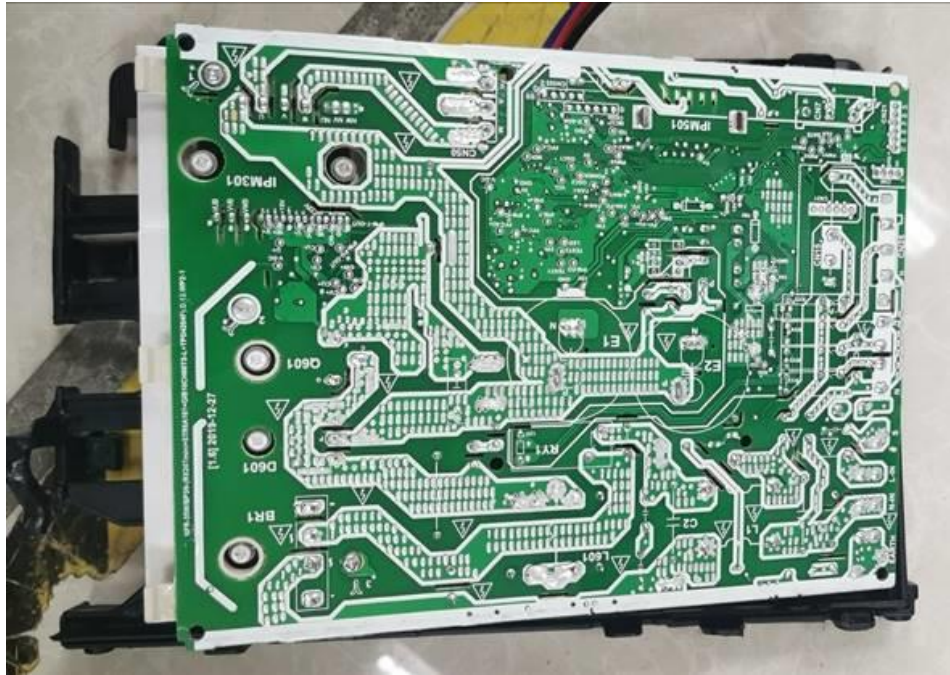

-- End of Attachment 5 ---

EN 60335-1: 2012/ A1 + A14+ A2 ATTACHMENT			
Clause	Requirement - Test	Result - Remark	Verdict

<b>ATTACHMENT TO TEST REPORT IEC 60335-1</b> <b>Household and similar electrical appliances – Safety –</b> <b>Part 1: General requirements</b>	
<b>Differences according to:</b>	EN 60335-1: 2012 /A1: 2019+ A14: 2019+A2: 2019 VS IEC 60335-1:2010/A1:2013+A2:2016
<b>Attachment Form No.:</b>	EN 60335_1
<b>Attachment Originator:</b>	SGS-CSTC
<b>Master Attachment:</b>	Date 2019-09

EN 60335-1: 2012 /A1: 2019			
<b>11</b>	<b>Heating</b>		--
11.8	Comment to be retained in the amendment: The deletion of the second sentence in the first paragraph was carried out in the existing common modifications.		P
	In Table 3 delete footnotes za, zb, zc, zd.		P
<b>24</b>	<b>Components</b>		--
	Comment to be retained in the amendment: The following text replaces common modification text in the existing standard by the IEC text including changes in A1. It also includes the paragraph from the EN 60335-1:2012 starting by "Plugs and socket-outlets and their connecting devices...." Replace the existing text by the following:		P
24.1	Components shall comply with the safety requirements specified in the relevant EN standards as far as they reasonably apply.		P
	Compliance with the EN standard for the relevant component does not necessarily ensure compliance with the requirements of this standard.		P
	Motors are not required to comply with EN 60034-1. They are tested as part of the appliance according to this standard.		P
	Relays shall be tested as part of the appliance according to this standard. They may be alternatively tested to EN 60730-1, in which case they shall also meet the additional requirements in EN 60335-1.		N/A

EN 60335-1: 2012/ A1 + A14+ A2 ATTACHMENT			
Clause	Requirement - Test	Result - Remark	Verdict
	Unless otherwise specified, the requirements of Clause 29 of this standard apply between live parts of components and accessible parts of the appliance.		P
	Unless otherwise specified, components may comply with the requirements for clearances and creepage distances for functional insulation as specified in the relevant component standard.		P
	Unless otherwise specified, the requirements of 30.2 of this standard apply to parts of non-metallic material in components including parts of non-metallic material supporting current-carrying connections inside components.		P
	Components that have not been previously tested and shown to comply with the EN standard for the relevant component are tested according to the requirements of 30.2 of this standard.		P
	Components that have been previously tested and shown to comply with the resistance to fire requirements in the EN standard for the relevant component need not be retested provided that		N/A
	— the severity specified in the component standard is not less than the severity specified in 30.2 of this standard, and		N/A
	— unless the pre-selection alternatives in 30.2 are used, the test report for the component states the values of $t_e$ and $t_i$ as required by EN 60695-2-11.		N/A
	If the above two conditions are not satisfied, the component is tested as part of the appliance		P
	Power electronic converter circuits are not required to comply with EN 62477-1. They are tested as part of the appliance according to this standard.		N/A
	Unless components have been previously tested and found to comply with the relevant EN standard for the number of cycles specified, they are tested in accordance with 24.1.1 to 24.1.9. For components mentioned in 24.1.1 to 24.1.9, no additional tests specified in the relevant EN standard for the component are necessary other than those specified in 24.1.1 to 24.1.9.		P

<b>EN 60335-1: 2012/ A1 + A14+ A2 ATTACHMENT</b>			
Clause	Requirement - Test	Result - Remark	Verdict
	Components that have not been separately tested and found to comply with the relevant EN standard and components that are not marked or not used in accordance with their marking, are tested in accordance with the conditions occurring in the appliance, the number of samples being that required by the relevant standard.		P
	Lamp-holders and starter-holders that have not been previously tested and found to comply with the relevant EN standard are tested as a part of the appliance and shall additionally comply with the gauging and interchangeability requirements of the relevant EN standard under the conditions occurring in the appliance. Where the relevant EN standard specifies these gauging and interchangeability requirements at elevated temperatures, the temperatures measured during the tests of Clause 11 are used.		N/A
	There are no additional tests specified for nationally standardized plugs such as those detailed in IEC/TR 60083 or connectors complying with the standard sheets of EN 60320-1 and EN 60309, unless they are specifically mentioned in the text of this standard.		P
	Plugs and socket-outlets and other connecting devices of interconnection cords shall not be interchangeable with plugs and socket-outlets listed in IEC/TR 60083 or IEC 60906-1 or with connectors and appliance inlets complying with the standard sheets of EN 60320-1, if direct supply to these parts from the supply mains could give rise to a hazard.		N/A
	When an EN standard does not exist for a component, there are no additional tests specified.		P
<b>EN 60335-1: 2012 /A14: 2019</b>			
<b>7</b>	<b>Marking and instructions</b>		--
7.10	Add the following text after the first paragraph of the addition:		P
	A push-push button switch used for start and stop the operation shall not be used for other functions such as changing the motor speed.		N/A

EN 60335-1: 2012/ A1 + A14+ A2 ATTACHMENT			
Clause	Requirement - Test	Result - Remark	Verdict
	For hand-held appliances with rated power input 50 W or lower it is acceptable to have a push-push button for different functions including on / off if there is an immediate feedback to the user e.g. by tactile feedback or audible and visible feedback.		N/A
	NOTE Z1 An example of such a function is: slow/ fast / off.		N/A
	Where a push button can cycle through various modes during a prolonged push this is allowed as long as the appliance will switch off with a single short push action.		N/A
	Renumber the current NOTE Z1 and NOTE Z2 by NOTE Z2 and NOTE Z3.		N/A
	Replace the first sentence of NOTE Z2 (was NOTE Z1) by the following:		N/A
	Audible feedback is any audible response got immediately after the operation of the switch. The click of a switch can be accepted as an audible feedback provided that it is originated inside the switch that is operated and can be heard at a distance of 77 cm from the switch. The sound of the motor is regarded as an audible feedback.		P
	Add the following text after the third paragraph of the addition:  Constructions with switches that have two different stable positions (meaning that it can be seen or felt when they have been pressed or rotated) are considered to have a tactile feedback.		P
<b>8</b>	<b>Protection against access to live parts</b>		--
8.1.1	Replace the first sentence of the replacement of the 3rd paragraph with the following:		P
	Test probe B and probe 18 of EN 61032 are applied with a force not exceeding 1 N, the appliance being in every possible position, except that appliances normally used on the floor and having a mass exceeding 40 kg are not tilted.3		P
8.1.3	Add the text “, test probe 18” after “test probe B,”		P
<b>15</b>	<b>Moisture resistance</b>		--
15.1.2	Put the text of the addition in italics.4		N/A

<b>EN 60335-1: 2012/ A1 + A14+ A2 ATTACHMENT</b>			
Clause	Requirement - Test	Result - Remark	Verdict
<b>20</b>	<b>Stability and mechanical hazards</b>		--
20.2	In the second paragraph replace the word "movable" by "moving" and replace "main function" by "working function".		P
<b>22</b>	<b>Construction</b>		--
22.12	Add to the first paragraph:		P
	Other parts that are intended to be detached during use, maintenance or cleaning (examples are batteries, battery covers, lids, attachments, steam nozzles) are not considered as parts providing a similar function as handles, knobs, grips, levers.		P
22.17	Add a new sentence to the requirement:		N/A
	This is not applicable to built-in appliances.		N/A
<b>24</b>	<b>Components</b>		--
24.1	Add before the last paragraph the following:		P
	NOTE Z3 For details of plugs used in CENELEC countries listed in IEC TR 60083 see Annex ZH.		P
<b>25</b>	<b>Supply connection and external flexible cords</b>		--
25.1	Addition Plugs and pins for insertion into socket outlets shall follow the relevant standards sheets in Annex ZH.		P
25.6	Delete the addition.		P
25.25	Replace the second sentence of the first paragraph and add the note: Dimensions of the pins and engagement face of plugs of appliances that are inserted into socket-outlets are to be in accordance with the dimensions of the relevant plug standard.		N/A
	NOTE Z1 Common plugs and socket-outlets types in CENELEC countries as shown in Annex ZH.		N/A
<b>32</b>	<b>Radiation, toxicity and similar hazards</b>		N/A
	Delete in the third paragraph "EN 50366 or"		P
<b>Annex ZA</b>	Special national conditions		N/A
<b>Annex ZB</b>	A-deviations		N/A
<b>Annex ZD</b>	IEC and CENELEC code designations for flexible cords		P

<b>EN 60335-1: 2012/ A1 + A14+ A2 ATTACHMENT</b>			
Clause	Requirement - Test	Result - Remark	Verdict
<b>Annex ZF</b>	Criteria applied for the allocation of products covered by standards in the EN 60335 series under LVD or MD		P
<b>Annex ZH</b>	Common plug and socket-outlet types in CENELEC countries		P
<b>Annex ZI</b>	Information on the application of A11:2014 to EN 60335-1:2012 CENELEC CLC/TC 61(SEC)2096A		N/A
<b>EN 60335-1: 2012 /A2: 2019</b>			
<b>7</b>	<b>Marking and instructions</b>		--
7.101	Delete the paragraphs starting with "Devices used to start/stop..." until the end of the requirement ".....by vulnerable persons.". This includes Notes Z1 and Z2.		P
7.12.Z12	Delete the sub clause.		P
7.14.	Delete Note Z1.		P
<b>22</b>	<b>Construction</b>		--
22.12	Delete Note Z1		P
<b>24</b>	<b>Components</b>		--
24.Z1	Replacement		N/A
	Type S2 and S3 capacitors according to EN 60252-1 are not required to undergo the testing as required by 30.2.2 and 30.2.3.1.		N/A
<b>25</b>	<b>Supply connection and external flexible cords</b>		--
25.7 <sup>3</sup>	Delete the existing text starting "Halogen free thermoplastic....." until ".....designation H07ZZ-F)."		N/A
<b>Annex ZC</b>	<b>Normative references to international publications with their corresponding European publications</b>		N/A

---End of the Attachment---