

User Guide

Bottle cooler controller ERC 111

This reference manual is intended to be used primarily by OEMs for the purposes of programming ERC 111. It may also be useful for technicians. It is not intended as a user guide for end users.



Introduction

Application Temperature control for refrigeration appliances.
Front panel mounting.

Advantages The latest generation CPU, plenty of memory and high-end electronic components allow for a uniquely versatile software. Three separate password-protected user levels can be used to control more than 300 different parameters to fit all individual requirements.



Approvals R290/R600a end-use applications employing in accordance to EN/IEC 60335-2-24, annex CC and EN/IEC 60335-2-89, annex BB
Glow wire according to EN/IEC 60335-1;
IEC/EN 60730;
UL60730;
NSF,
CQC;
GOST R 60730.

Password protected

The access level can be set separately for each parameter using "KoolProg Software".
There are three levels of access 1, 2, 3:
- level 1 is for shop access;
- level 2 for technicians;
- level 3 for OEMs.
The access levels cannot be set using the buttons. Passwords for the different levels can however be altered for the level of access you have, e.g. a level 2 user can change the password for level 1 and level 2 but not level 3.

Typical application

Glass Door Merchandiser

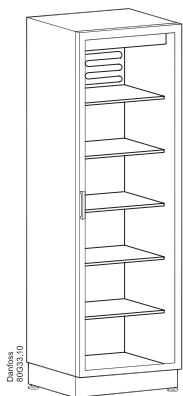

Danfoss
ERC111A

Outputs*:

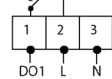

ERC 111 A
No. 080G3230
100-240Vac +/-10% 50/60Hz
Red display



Inputs*:

S1	S2	di
Analog /Digital		Comm.

* Other functions see instruction

Rating:

	c us		14
DO	240Vac	120Vac	240Vac
1	10A,10FLA/60LRA,0T55	16FLA/72LRA,0T55	16(16)A,0T45;10(10)A,0T55



Gastro cooler

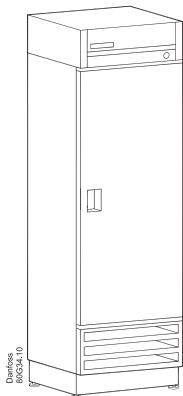

Danfoss
ERC111A

Outputs*:



ERC 111 A
No. 080G3235
100-240Vac +/-10% 50/60Hz
Red display



Inputs*:

S1	S2	di
Analog /Digital		Comm.

* Other functions see instruction

Rating:

	c us		14
DO	240Vac	120Vac	240Vac
1	10A,10FLA/60LRA,0T55	16FLA/72LRA,0T55	16(16)A,0T45;10(10)A,0T55



Product overview

Display



Buttons



The ERC 111 is an electronic refrigeration controller with an LED display especially developed for bottle coolers and commercial fridges and freezers. It is particularly suited for OEM customers where time, easy and reliable installation and high quality need to go hand in hand with flexibility.

The display can be ordered in red or blue. The controller is available with the upper left button as "Defrost". The lower left-button can be supplied with "Stand by".

Clips

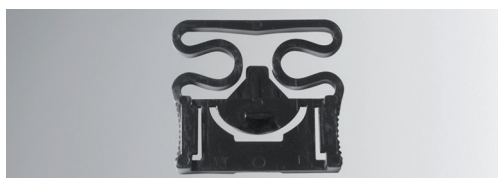

Are used to secure the controller in place in the case of rear mounting. They are not used with front mounting. There are two identical clips, one placed on either side of the controller.

Front frame



Controller without front frame

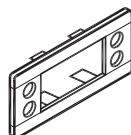

Front frame

At front mounting place the wired controller in the hole. Then press the front frame in position. The plastic lugs locks hereby the controller.

"S1"

Temperature sensor for cabinet

"S2"

Temperature sensor for defrost

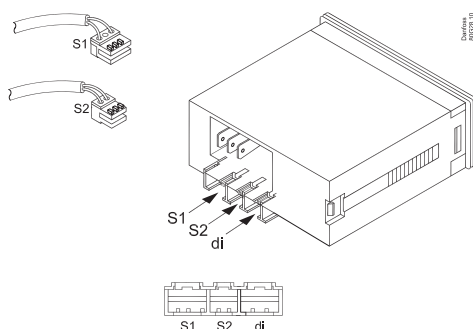

Control temperature sensor

There are different lengths.

Defrost temperature sensor

Should be mounted on the evaporator.

The function of an input can be reprogrammed, but the connector can not be moved. The connector is designed to only one location. "S1" to "S1", "S2" to "S2", etc.

Quick programming

Software for PC



KoolProg

Software from Danfoss for programming the ERC-controller via a PC rather than with the front panel buttons.

<https://www.danfoss.com/en/service-and-support/downloads/dcs/koolprog/>

USB gateway



USB gateway

The USB Gateway is a laboratory tool, offering fast and easy programming of any ERC controller connected directly to the PC. "KoolProg Software" installation kit is provided for the PC. The gateway is standard inventory for OEM labs.

USB programming key



Programming an individual unit in a laboratory

The USB key requires "KoolProg Software" running on a PC. It enables parameters to be set in real time and an array of status information to be read (bidirectional connection). Once the desired settings have been determined, a specific parameter file is saved to the USB key for later mass programming through the docking station.

Docking station

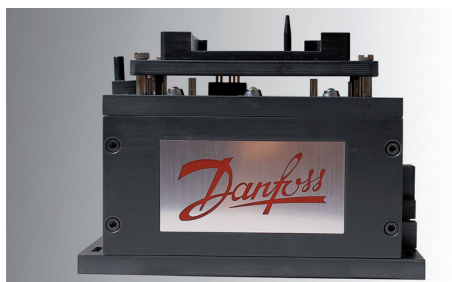

Mass programming on an assembly line:

The docking station is used for high volume programming of ERC controllers, for example on an assembly line. The docking station is a write-only device. The USB key, is to be inserted into the docking station. The settings are then loaded into each successive controller in a matter of seconds. "KoolProg Software" is not required for mass programming.

Technical specs

Power Supply	100 - 240 V AC Switch mode power supply. Average 0.7 W		
Input	3 inputs: 2 analogue (digital), 1 digital; user specific assignment • Air/evaporator/condenser		
Output		UL60730	EN60730
	"DO1" (Compressor relay)	120 V AC: 16 A resistive/FLA16/LRA72 240 V AC: 10 A resistive/FLA10/LRA60	16(16) A
Probes	Danfoss NTC sensors and Danfoss ERC accessories		
Connectors	Modular connector system for OEM customers, with optional output screw terminal adapter; Input connector type: Rast2 5 Edge connectors; output connector type: RAST 5 standard		
Programming	Programming with Danfoss KoolProg PC software, Docking station and Programming key		
Assembly	Front mounting; brackets; fully integrated solution (requires OEM specific design of mounting hole)		
Display	LED display, 3 digit, decimal point and multi functionality icons; °C/°F scale		
Keypad	4 buttons (integrated IP65 design), 2 left, 2 right; user programmable		
Operating Conditions	0 °C to 55 °C, 93% rH		
Storage Conditions	-40 °C to 85 °C, 93% rH		
Range of Measurement	-40 °C to 85 °C		
Protection	Front: IP65 Rear: water and dust protection corresponds to IP31, accessibility of connectors limit rear part rating to IP00		
Environmental	Pollution degree II, non-condensing		
Resistance to heat & fire	Category D (UL94-V0)		
EMC category	Category I		
Operating Cycles	Compressor relay: more than 175,000 at full load (16A(16A))		
Approvals	R290/R600a end-use applications employing in accordance to EN/IEC 60335-2-24, annex CC and EN/IEC 60335-2-89, annex BB Glow wire according to EN/IEC 60335-1 IEC/EN 60730 UL60730 NSF CQC GOST R 60730		These approvals are only valid when using the accessories listed in this document

IMPORTANT NOTE

The inputs are not galvanic separated and are connected directly to the mains supply!
For that reason, door-switches, sensors as well as the cables must fulfil the reinforced insulation requirements.

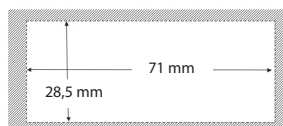
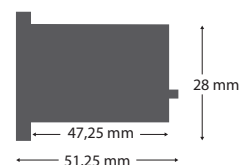
Dimensions

Front mounting
(Lock with frame)

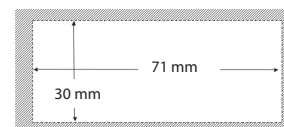

Rear mounting
(Lock with clips)

Connections

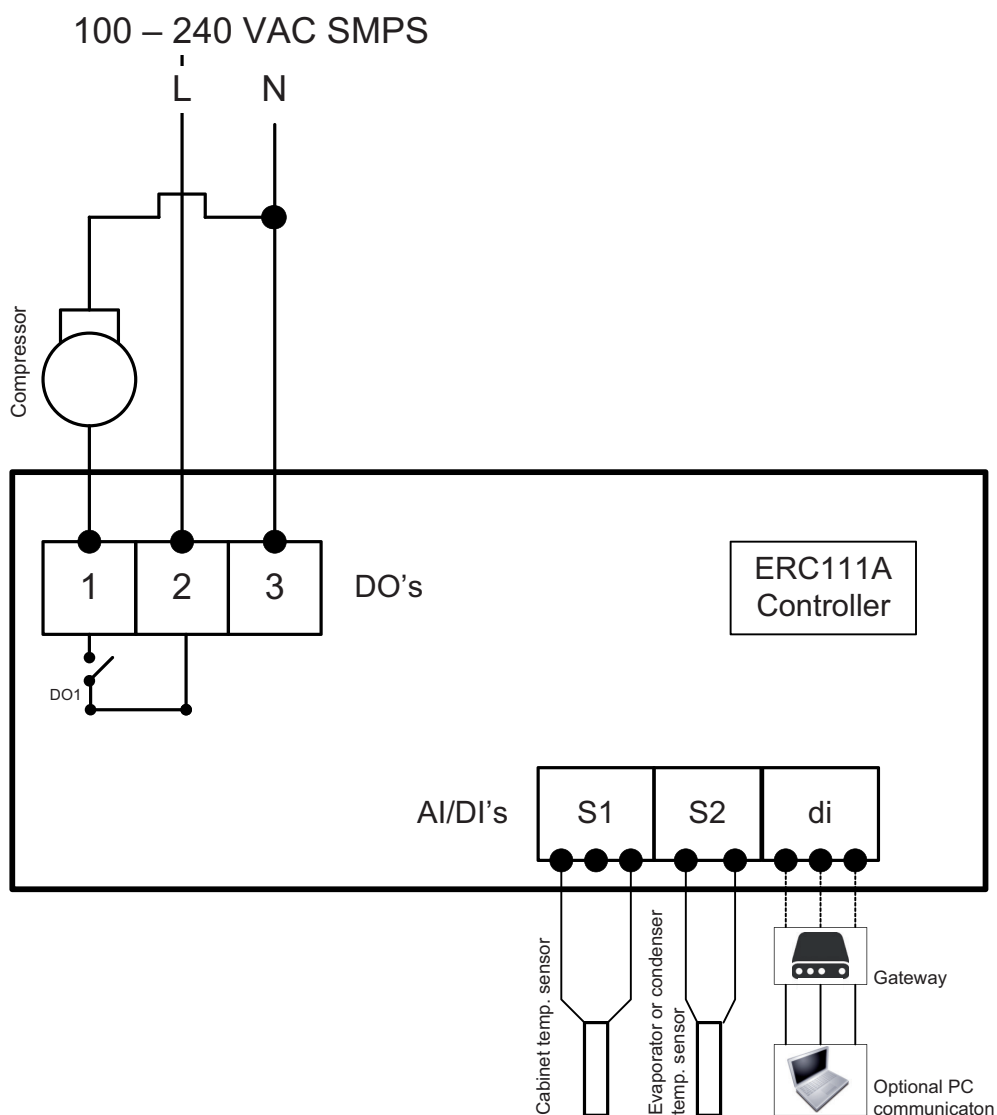

Code numbers

Type	Code no. I-Pack
ERC 111, Red LED, without buzzer	080G3230
ERC 111, Blue LED, without buzzer	080G3231
ERC 111, Red LED, with buzzer	080G3235
ERC 111, Blue LED, with buzzer	080G3236
Version with buzzer is available only on demand	
Temperature sensors	
<i>-40 – 85 °C, PVC Standard, NTC 5 K</i>	
S1, 470 mm, 3-pole	077F8751
S1, 1000 mm, 3-pole	077F8757
S1, 1500 mm, 3-pole	077F8761
S1, 2000 mm, 3-pole	077F8765
S1, 2200 mm, 3-pole	077F8767
S1, 3000 mm, 3-pole	077F8769
S1, 3500 mm, 3-pole	077F8723
S1, 6000 mm, 3-pole	080G2019
<i>-40 – 120 °C, TPE precision NTC 5 K, Santroprene</i>	
S1, 1500 mm, 3-pole	077F8726
S1, 2000 mm, 3-pole	077F8727
S1, 3000 mm, 3-pole	077F8729
<i>-20 – 175 °C, Silicone rubber cable, NTC 100 K</i>	
S1/S3, 1000 mm, 3-pole	080G2041
S1/S3, 2000 mm, 3-pole	080G2043
S1/S3, 3000 mm, 3-pole	080G2045
<i>-40 – 85 °C, PVC Standard, NTC 5 K</i>	
S2, 1000 mm, 2-pole	077F8786
S2, 1500 mm, 2-pole	077F8790
S2, 2000 mm, 2-pole	077F8794
S2, 3000 mm, 2-pole	077F8798
S2, 6000 mm, 2-pole	080G2029

Type	Code no. I-Pack
Clips	
Black (2 needed per controller)	080G3308
Programming	
OEM Docking station, production line	080G9701
Programming key EKA183A	080G9740
Gateway incl USB Cable for R&D	080G9711
Power Plug*	
3-pole with screw	080G3356
*available optional plugs with screw connection are limited to 16A	

Sx (di)= connector position.
Inputs are configurable.

NOTE: For more information about temperature sensor types and connectors, please refer to Danfoss' technical brochure "NTC type temperature sensors for ETC & ERC controllers".

Operation

KoolProg Software/Gateway

The controller can be controlled in three ways: Using "KoolProg Software", the Danfoss Docking Station or manually by means of the buttons on the front panel. "KoolProg Software" is licenced Danfoss software offering easy parameter set up via a USB gateway. This software is supplied separately; for technical literature and further information, please contact your local Danfoss representative.

Docking station

Docking station is supplied separately. For further information, please contact your local Danfoss representative.

Manual operation with buttons (Direct Access)

1 Press: variable direct function, e.g. defrost
Sub function: "back"

1 Press: variable direct function, e.g. ON/OFF
Sub function: "OK"

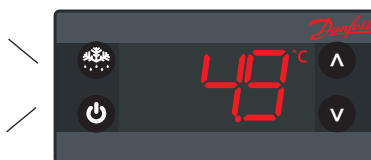

1 Press: temperature set point
Sub function: "up"

1 Press: temperature set point
Sub function: "down"

Examples

Changing the Desired Temperature Set point:

1. The display shows the current temperature.
 2. Press "up/down" to access set point.
 3. Press "up/down" to adjust set point.
- After 30 seconds, the display automatically reverts to showing the current temperature

Acknowledging Alarms:

1. Display Flashing the alarm message.
2. Press any button to acknowlege.

Password protection:

1. Press "up/down" and hold 5 seconds to access the menu.
2. The display shows "PAS".
3. Press "OK".
4. Press "Up/Down" to the code.
5. Press "OK".

Password protection on three levels:

1. Level 1: "shop" (daily use by shop personnel).
2. Level 2: "ser" (service technician).
3. Level 3: "OEM" (OEM programming).

Changing a Parameter

Some parameters may be hidden to you. When scrolling through menus, the parameters available will have been pre-determined using "KoolProg Software".

Your access level will determine which parameters you can view and edit:

1. Press "up/down" and hold 5 seconds to access the menu.
2. First parameter group is shown "tHE".
3. Press "up/down" to find the desired group.
4. Press "OK".
5. First parameter is shown.
6. Press "up/down" to find the desired parameter.
7. Press "OK".
8. Press "up/down" to find the desired setting.
9. Press "OK".

After 30 seconds, the display automatically reverts to showing the current temperature. Or Press 2 x "Back".

NOTE:

Incorrect parameter settings can lead to inadequate cooling, excessive energy consumption, unnecessary alarms and in the case of temperature-sensitive food storage, breaches in food hygiene principles and regulations.

Only a trained operator should make changes to parameters.

Menu/functions

ERC menu code		Description
"tHE"		Thermostat settings
"SEt" Min. -100.0°C Max. 200.0°C Default 2.0°C	Set point This parameter defines the desired temperature (set point) In standard operation the set point is changed by simply pressing the "temperature up/down" buttons on ERC 111; for laboratory and assembly line you may opt for software controlled set point adjustment (speed improvement)	
"SPr" Min. 0.0 Max. 1.0 Default 0.5	Current set point adjustment value diF * SPr The default value is set to 0.5 and the parameter is hidden by default. "Spr" defines the position of the set point in relation to cut-in and cut-out "Spr=0,5" sets the set point mid between cut-in and cut-out. "Spr=0" sets the set point at the cutout. "Spr=1" sets the set point at cut-in	
"diF" Min. 0.0 K Max. 20.0 K Default 2.0 K	Thermostat differential This defines the difference between the cut-out and the cut-in The desired temperature is determined by "SPr" and "diF"	
"HSE" Min. -100.0°C Max. 200.0°C Default 50.0°C	Upper limit of thermostat set point Define the temperature range limit of the controller Once set, the desired temperatue (set point) can not go above "HSE" or below "LSE"	
"LSE" Min. -100.0°C Max. 200°C Default -35.0°C	Lower limit of thermostat set point Define the temperature range limit of the controller Once set, the desired temperatue (set point) can not go below "LSE"	
"iC" Min. no Max. yes Default no	Initial cut in Comp relay action when Tair is between cut-in and cut-out at power-up: "yES": cut in the compressor "no": cut out the compressor	
Pud		Pull Down settings
		Pull down (sometimes known as Super Cool) is a procedure for improving cooling performance, accelerating the time used to reach the desired temperature. Pull down settings overrule all other settings.
"PCy" Min. 0 min Max. 360 min Default 30 min	Pull Down Cycling This is the duration in minutes of the compressor cycling at the reduced set point temperature. Once the desired pull down limit temperature "PLt" has been reached during pull down, the compressor will continue to cycle ON/OFF for the duration of "PCy". At the end of the period defined by "PCy", the set point temperature will return to normal and pull down will cease.	
"Pdi" Min. 0 hour Max. 48 hour Default 15 hour	Pull Down Defrost Interval Even though most applications do not need Defrost during pull down, an extended defrost during pull down can be applied. This is the time between defrost cycles during pull down. It is measured in hours and can be up to 48 hours. During pull down, this setting overrides the defrost interval and defrost time settings (see the defrost section).	
"Pdd" Min. 0 hour Max. 48 hour Default 24 hour	Pull Down Duration You can choose to limit the maximum pull down time. Once this time value (max. 48 hours) is reached, pull down will stop regardless of whether the desired pull-down temperature has been reached.	
"PLt" Min. -55.0°C Max. 55.0°C Default 0.0°C	Pull Down Limit Temperature This parameter sets the minimum allowed temperature during pull-down. In order to protect valuable contents you must always specify the absolute minimum temperature allowed in your application. For glass door merchandisers 0°C/32°F protects bottles from freezing; for commercial fridges you may opt for a slightly higher temperature (e.g. 2°C)	

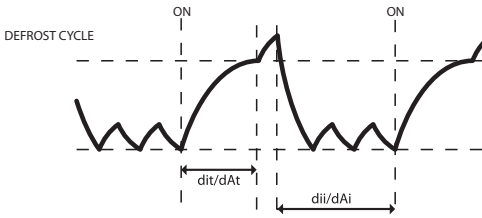
dEF		Defrost settings
	"dFt" Default no	Defrost Type "no": defrost function is disabled. "nat": OFF-cycle defrost (natural defrost).
	"Add" Min. no Max. yes Default no	Adaptive defrost "no": defrost controlled by time. "yES": automatic defrost control activated.
	"dtt" Min. 0.0°C Max. 25.0°C Default 6.0°C	Terminate Temperature This parameter defines at what temperature the defrost cycle will stop. The temperature is given by the evaporator sensor or by the cabinet temperature sensor if no evaporator sensor is used.
	"drt" Min. 0.0°C Max. 200.0°C Default 5.0°C	Defrost reset temperature The defrost counter is saved and restored at power-up, but if the temperature sensor, used for defrost, is higher than this value at power-up, it is assumed that the evaporator is free of ice and the defrost counter will be cleared.
	"dii" Min. 1 hour Max. 96 hour Default 6 hour	Defrost minimum Interval/dii Defines the minimum time period between the start of two defrost cycles. Once the minimum interval has expired, the defrost cycle will start at the following cut-out or once the maximum interval "dAi" has been reached. 
	"dAi" Min. 1 hour Max. 96 hour Default 7 hour	Maximum Interval Defines the maximum time period between the start of two defrost cycles.
	"dit" Min. 0 min Max. 240 min Default 5 min	Minimum Time Defines the minimum duration of a defrost cycle. During this period, the controller will not check the temperature. Once the minimum time has expired, the temperature will be checked and if the terminate temperature "dtt" has been reached, the defrost cycle will end. If dtt has not been reached, defrost will continue until either dtt is reached or the maximum time "dAt" reached, whichever occurs first.
	"dAt" Min. 0 min Max. 480 min Default 30 min	Maximum Time Defines the maximum duration of a defrost cycle. The controller will not allow a maximum time to be entered which is less than the minimum time, or a minimum time which is more than the maximum time.
	"dCt" Min. no Max. yes Default no	Defrost ON Compressor Time If this parameter is set to "yES", then defrost cycles are based on the total time the compressor has been running. If this parameter is set to no, then defrost cycles are related to elapsed time, regardless of how long and how often the compressor has been on.
	"doC" Min. 0 hour Max. 24 hour Default 0 hour	Defrost by Comp. running time Continuous compressor running can cause defrost. "0" = deactivated
	"dEt" Min. -50.0°C Max. 0.0°C Default -50.0°C	Defrost start evaporator temp Defrost start trigger for adaptive defrost.

<p>"ddt"</p> <p>Min. 0.0 K Max. 30.0 K Default 5.0 K</p>	<p>Defrost Δt</p> <p>Defrost Δt compare with evaporator temperature of first cut out after defrost to trigger defrost start. The defrost start if evaporator temperature has decreased</p>	
<p>"idd"</p> <p>Min. 0 hour Max. 96 hour Default 3 hour</p>	<p>Initial Defrost Interval</p> <p>The initial defrost interval determines the time for first defrost after power-up. The initial defrost is mainly intended for factory testing of the defrost functionality and can be set to expire after a number compressor cycles according to the setting of parameter idd. During normal operation, the defrost counter will be saved in memory and restored after power loss, making the initial defrost unnecessary.</p>	
<p>"idd"</p> <p>Min. 0 Max. 999 Default 100</p>	<p>Initial Defrost Duration</p> <p>The initial defrost duration is the number of compressor cycles before the initial defrost is deactivated.</p> <p>"0": "idd" No initial defrost. "1-998": number of compressor cycles before deactivation. "999": initial defrost always active.</p>	
<p>CoP Compressor settings</p>		
<p>"uPt"</p> <p>Min. no Max. yes Default no</p>	<p>Voltage protection</p> <p>"no": no voltage protection. "yES": voltage protection activated based on voltage related settings.</p>	
<p>"uLi"</p> <p>Min. 0 V AC Max. 270 V AC Default 0 V</p>	<p>Minimum cut-in voltage/uLi. Minimum cut-out voltage/uLo. Maximum voltage/uHi</p> <p>These three parameters provide voltage protection to the compressor. Start by setting "uHi", followed by "uLo" and "uLi".</p>	
<p>"uLo"</p> <p>Min. 0 V AC Max. 270 V AC Default 0 V</p>	<p>"uLi": when the compressor is due to start, the voltage of the power supply will be checked and the compressor will only be allowed to start if it is at least the value given in this parameter.</p> <p>"uLo": when the compressor is running, it will be switched OFF if the voltage goes below that given in this parameter.</p>	
<p>"uHi"</p> <p>Min. 0 V AC Max. 270 V AC Default 270 V</p>	<p>"uHi": when the compressor is running, it will be switched OFF if the voltage exceeds that given in this parameter. If the compressor is already stopped, it will remain switched OFF.</p>	
<p>"EHd"</p> <p>Default no</p>	<p>Sensor Error Type</p> <p>"no": no sensor error handling. "SEt": in case of control sensor error, follow error run/stop time. "Aut": automatical sensor error handling.</p>	
<p>"Ert"</p> <p>Min. 0 min Max. 60 min Default 0 min</p>	<p>Error Run Time</p> <p>The parameter only become active in the unlikely event of a broken temperature sensor. It is used to run the application in safety mode. At the same time the sensor error will be shown in the display.</p> <p>"Ert" define the duration the compressor will run.</p> <p>Example: "Ert=4" [min] and "ESt=16" [min] will provide an average cooling system activity of 20%. Ert and "ESt" values are based on OEM experience and are by default inactive.</p>	
<p>"ESt"</p> <p>Min. 0 min Max. 60 min Default 1 min</p>	<p>Error Stop Time</p> <p>The parameter only become active in the unlikely event of a broken temperature sensor. It is used to run the application in safety mode. At the same time the sensor error will be shown in the display.</p> <p>"ESt" define the duration the compressor will be "idle".</p>	

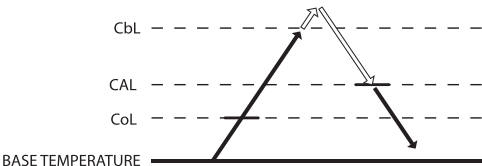
	<p>"CSt"</p> <p>Min. 0 min Max. 30 min Default 2 min</p>	<p>Minimum Stop Time</p> <p>It determines the minimum number of minutes the compressor must remain idle before a Temperature cut-in can take effect. For example, if the temperature sensor indicates that the cut-in temperature has been reached, but the number of minutes set in this parameter have not elapsed since the compressor last stopped, then the compressor will stay OFF. It will only start once the duration given by "CSt" has been reached provided the temperature is still high enough. "CSt" thus overrides the cut-in.</p>
	<p>"Crt"</p> <p>Min. 0 min Max. 30 min Default 0 min</p>	<p>Minimum Run Time</p> <p>It determines the minimum number of minutes the compressor must run before a Temperature cut-out can take effect. For example, if the temperature sensor indicated that the cut-out temperature has been reached, but the number of minutes set in this parameter have not elapsed since the compressor last started, then the compressor will continue. It will only stop once the duration given by "Crt" has been reached – provided the temperature is still low enough. "Crt" thus overrides the cut-out.</p>
	<p>"Cot"</p> <p>Min. 0 min Max. 480 min Default 0 min</p>	<p>Maximum OFF Time</p> <p>This is the maximum time in minutes the compressor is allowed to "idle" – up to 480 minutes. Cot is set to zero by default (inactive). If the controller is used on a draft beer (ice bank) application, this parameter can be used to control the ice thickness.</p>
	<p>"Pod"</p> <p>Min. 0 s Max. 300 s Default 300 s</p>	<p>Power ON Delay</p> <p>This is the delay in seconds between power-on and the compressor being activated. Depends on the power ON temperature setting.</p>
	<p>"PF1"</p> <p>Min. -90° Max. 90° Default 0°</p>	<p>Power Factor</p> <p>"PF1": relay 1.</p> <p>Power factor (phasic angle) is introduced in zero crossing function which is used for cut-in/out compressor at the proper timing for prolonging the lifespan of relay. (Can only be accessed by Danfoss).</p>
	<p>"Pot"</p> <p>Min. -100.0°C Max. 200.0°C Default -100.0°C</p>	<p>Power ON Temperature</p> <p>This parameter is used to accelerate the first application test on the OEM assembly line; if the cabinet temperature is higher than this parameter the power ON Delay is overruled and the outputs are activated without delay.</p>
<p>Con</p>		<p>Condenser Protection settings</p>
		<p>NOTE: A condenser temperature sensor is required to use these parameters. Condenser protection is generally used in dusty environments where the condenser may accumulate a layer of dust or dirt and therefore be at risk of overheating.</p>
	<p>"CAL"</p> <p>Min. 0°C Max. 200°C Default 80°C</p>	<p>Condenser Alarm Limit/CAL</p> <p>This parameter sets the temperature for the condenser at which an alarm will be generated.</p> 
	<p>"CbL"</p> <p>Min. 0°C Max. 200°C Default 85°C</p>	<p>Condenser Block Limit/CbL</p> <p>This parameter sets the temperature which if reached will cause the compressor to switch OFF.</p>
	<p>"CoL"</p> <p>Min. 0°C Max. 200°C Default 60°C</p>	<p>Condenser OK Limit/CoL</p> <p>This parameter sets the temperature at which the compressor is allowed to start again after the temperature set in "CbL" above has been exceeded and the compressor stopped.</p>

	"CLL" Min. -100°C Max. 20°C Default -5°C	Condenser Low Limit/CLL This parameter sets the lowest (condenser) temperature at which the compressor is allowed to start.
diS	Display settings	
	NOTE: some display parameters can be set in such a way that they may be illegal in some jurisdictions. Please check local legislation.	
	"din" Min. 2 Max. 10 Default 10	Display Intensity The controller can have its display intensity (brightness) set in one of two ways: A) With a Danfoss ambient light sensor attached, the brightness of the display is adjusted automatically according to the ambient light level (see the assignments section). B) When no ambient light sensor is attached, the display intensity can be set to a fixed intensity. Both options are on a scale of 1 to 10, where 10 is the brightest.
	"CFu" Min. °C Max. °F Default °C	Display Unit This parameter sets the display to Fahrenheit or Celsius. Switching from one to the other will cause all temperature settings to be automatically updated accordingly.
	"trS" Default SCo	Temp sensor to display "SCo": temperature control. "EuA": evaporator temperature. "Con": condenser temperature (condenser cleaning). "AuS": only for showing on display.
	"rES" Min. 0.1 Max. 1 Default 0.1	Display Resolution This parameter can be set to 0.1, 0.5 or 1 and affects the way the temperature is displayed. With the parameter set to 1, the display will only ever show temperatures rounded to the nearest whole degree. At 0.5, it will round the temperature to the nearest half degree for display. For example, 3.3 degrees will be shown in the display as 3.5 degrees and 3.9 as 4.0. With the parameter set to 0.1, no rounding occurs. This parameter does not affect the temperature itself, merely the display.
	"rLt" Min. no Max. yes Default no	Display Range Limit In some point of sales applications you may want to show the desired instead of the real temperature. This parameter sets whether the displayed temperature is the actual temperature or whether it is restricted to the cut-in / cut-out limits. Set to "no" means that the actual temperature will be displayed. The parameter is set to "no" by default.
	"ddl" Min. 0 s Max. 10 min Default 0 min	Display Delay In order to provide a realistic temperature appearance for an application, a display delay can be set. The parameter sets the time constant τ (tau) of the moving average filter for the display. Physically, one time constant represents the time it takes the system's step-response to reach 66% of its final value and five time-constants the time it takes to reach 99% of its final value.
	"doF" Min. -10.0 K Max. 10.0 K Default 0.0 K	Display Offset This parameter is a relative value and allows the temperature displayed to be different to the temperature measured. For instance, at a measured temperature of 7°C and "doF" set to -2K, the displayed temperature will be 5°C instead.

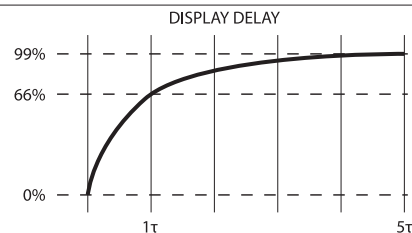

	"dLt" Min. 0 min Max. 60 min Default 15 min	Lock Time After Defrost In order not to show a rising temperature during defrosting, the displayed temperature is locked at the temperature shown at the start of the defrost cycle for the number of minutes set in this parameter. "0": no lock.
	"SSC" Min. no Max. yes Default no	Show Pull down state If set to "yES", this parameter causes the display to show SC when the system is in pull down mode. If set to "nO", the temperature continues to be displayed.
	"SHo" Min. no Max. yes Default no	Show Holiday "no": display will show temperature or ECO mode during holiday mode. "yES": display will show "HoL" during holiday mode.
	"SdF" Min. no Max. yes Default yes	Show Defrost If set to "yES", this parameter causes the display to show DEF when the system is in defrost mode. If set to "nO", the temperature continues to be displayed.
	"SCS" Min. no Max. yes Default yes	Show compressor symbol "no": compressor symbol will not show on display. "yES": show compressor symbol on display.
	"SdS" Min. no Max. yes Default yes	Show Defrost symbol "no": defrost symbol will not show on display. "yES": show defrost symbol on display.
	"idp" Min. 0 Max. 15 Default 15	Info Menu Display Item Switch of display items in Info menu. Visible on "KoolProg Software" ONLY. Data structure: 0,0,0,0, (alarm item), (average item), (low temp), (high temp)".
ALA		Alarm settings
	"HAt" Min. -100.0°C Max. 200°C Default 15.0°C	High Temp Alarm Absolute value. By setting "HAt" to the maximum alarms will be deactivated.
	"LAt" Min. -100.0°C Max. 200°C Default -50.0°C	Low Temp Alarm Absolute value. By setting "LAt" to the minimum value, alarms will be deactivated. In most situations, the low alarm delay will be set to 0 to warn about too low a temperature immediately.
	"Htd" Min. 0 min Max. 240 min Default 30 min	Alarm delay on high temperature alarm The number of minutes to wait before sounding an alarm once the high temperature alarm temperature is reached.
	"Ltd" Min. 0 min Max. 240 min Default 0 min	Alarm delay on low temperature alarm The number of minutes to wait before sounding an alarm once the low temperature alarm temperature is reached.
	"Pdd" Min. 0 min Max. 960 min Default 240 min	Pull down delay Normally, it is not necessary or desirable to sound an alarm during a pull down (the initial phase of reaching the desired temperature). This parameter prevents the high temperature alarm "HAt" sounding during pull down and after a defrost for the number of minutes set for the parameter. NOTE: it does not apply to the low temperature alarm "LAt".
	"uAL" Min. no Max. yes Default no	Voltage alarm "no": no voltage alarm. "yES": voltage alarm activated.
	"LEA" Min. 0 hour Max. 96 hour Default 0 hour	Leakage alarm Leakage detection for compressor protection. "0": disable

	<p>"Abd"</p> <p>Min. 0 min Max. 999 min Default 0 min</p>	<p>Alarm Buzzer Duration</p> <p>The alarm sounds for 10 seconds, followed by silence for 50 seconds. One alarm sequence therefore lasts 60 seconds. These values cannot be changed. This parameter determines how long in minutes an audible alarm will continue while there is still a reason to have an alarm. If set to 999, the alarm will continue to sound until the reason for the alarm is cleared – for example the temperature has dropped enough or the door closed. In some cases, it may be necessary for a user or technician to take action in order to clear the alarm. If set to 0, the alarm will never sound.</p>
	<p>"ACA"</p> <p>Min. no Max. yes Default yes</p>	<p>Auto Clear of Alarm/Error/ACA</p> <p>If this parameter is set to "nO": The alarm status will not disappear automatically even if the condition which caused the alarm is no longer valid or present.</p> <p>If set to "yES": As soon as the condition which caused the alarm is no longer valid or present, the alarm status will automatically change back to inactive. There will be no trace of the alarm having occurred. In general, glass door merchandise applications will be set to "yES" and commercial fridges and freezers set to "nO". For example, if the temperature goes too high for a period there may be food safety considerations in a freezer containing food but not in a fridge with cold drinks.</p> <div data-bbox="986 663 1477 819" style="float: right;"> </div>
ECS		ECO strategy
	<p>"tto"</p> <p>Min. 0 hour Max. 168 hour Default 0 hour</p>	<p>Time to pull down</p> <p>Time which ERC stay in holiday mode to decide to enter pull down or serving mode.</p>
ECA		ECO management
	<p>"Hto"</p> <p>Min. -25,0 K Max. 25,0 K Default 6,0 K</p>	<p>Holiday Temperature Offset</p> <p>Increase or decrease of temperature with respect to normal mode during holiday mode.</p>
ASi		Assignments settings
	<p>"uSA"</p> <p>Min. no Max. yes Default no</p>	<p>MODBUS Safety</p> <p>"on": MODBUS auto detection is enabled. "yES": MODBUS communication is deactivated.</p>
	<p>"t1A"</p> <p>Min. -20,0 K Max. 20,0 K Default 0,0 K</p>	<p>Air Temperature Adjustment (applies to non-Danfoss temperature sensors only)</p> <p>This parameter is a relative value and allows adjustment of the control sensor temperature.</p>
	<p>"t2A"</p>	<p>For instance, at a measured temperature of 7°C and "tAd" set to -2 K, the input from the control sensor will be 5°C instead.</p>
		<p>Inputs and outputs are configurable</p> <p>There are two steps:</p> <ol style="list-style-type: none"> Define the type of sensor attached to the input: <ul style="list-style-type: none"> temperature: light/digital. Define the application for the sensor: <ul style="list-style-type: none"> temperature: control/condenser/evaporator. light: ECO/display/both. motion digital: door sensor. <p>Please contact your local Danfoss representative for information about default settings.</p> <p>NOTE: coded sensors will impact on the number of possible configurations. For instance: Danfoss supplies only 2-pole defrost sensors, so input "S3" will most likely be used as a defrost/evaporator temperature sensor input.</p>

<p>"S1C" Default Stn</p>		<p>S1 Config/S1C S2 Config/S2C S3 Config/S3C</p>																									
<p>"S2C" Default Stn</p>		<p>S4 Config/S4C Available options are: "Stn": for a standard temperature sensor NTC 5 K @ 25°C and TPE precision. "Htn": for a high temperature sensor NTC 100 K @ 25°C.</p>																									
<p>"S1A" Default SCo</p>		<p>S1 Application/S1A S2 Application/S2A S3 Application/S3A S4 Application/S4A</p>																									
<p>"S2A" Default nC</p>		<p>Available options are: "nC": not connected. "SCo": temperature control. "EuA": evaporator temperature. "Con": condenser temperature (Condenser cleaning). "AuS": only for showing temperature on display.</p>																									
<p>"o1C" Default CoP</p>		<p>D01 Config "CoP": direct compressor control. "PiC": pilot Relay (no zero cross) – if using pilot relay to control a compressor, this option must be used instead of "CoP". "HEt": heating application, inverse output. "PiH": pilot heat relay (no zero cross).</p>																									
<p>"b1C" Default noP</p>		<p>Lower left button: Button 1 Config (short press)/b1C Button 1 Config (long press)/b1L</p>	<p>The buttons can be programmed as follows:</p> <table border="1" data-bbox="839 969 1477 1267"> <thead> <tr> <th>Short press function</th> <th>Long press function</th> </tr> </thead> <tbody> <tr> <td>"noP": not operating</td> <td>"noP": not operating</td> </tr> <tr> <td>"tP": increase set point</td> <td>"tP": increase set point</td> </tr> <tr> <td>"tn": decrease set point</td> <td>"tn": decrease set point</td> </tr> <tr> <td>"dEF": toggle defrost</td> <td>"dEF": toggle defrost</td> </tr> <tr> <td>"SuP": toggle super-cool/pull down</td> <td>"SuP": toggle super-cool/pull down</td> </tr> <tr> <td>"diP": increase display intensity</td> <td>"diP": increase display intensity</td> </tr> <tr> <td>"din": decrease display intensity</td> <td>"din": decrease display intensity</td> </tr> <tr> <td>"CFA": toggle °C and °F</td> <td>"CFA": toggle °C and °F</td> </tr> <tr> <td></td> <td>"PoF": ERC power ON/OFF</td> </tr> <tr> <td></td> <td>"HoL": enter holiday mode</td> </tr> <tr> <td></td> <td>"inF": enter info menu</td> </tr> </tbody> </table>	Short press function	Long press function	"noP": not operating	"noP": not operating	"tP": increase set point	"tP": increase set point	"tn": decrease set point	"tn": decrease set point	"dEF": toggle defrost	"dEF": toggle defrost	"SuP": toggle super-cool/pull down	"SuP": toggle super-cool/pull down	"diP": increase display intensity	"diP": increase display intensity	"din": decrease display intensity	"din": decrease display intensity	"CFA": toggle °C and °F	"CFA": toggle °C and °F		"PoF": ERC power ON/OFF		"HoL": enter holiday mode		"inF": enter info menu
Short press function	Long press function																										
"noP": not operating	"noP": not operating																										
"tP": increase set point	"tP": increase set point																										
"tn": decrease set point	"tn": decrease set point																										
"dEF": toggle defrost	"dEF": toggle defrost																										
"SuP": toggle super-cool/pull down	"SuP": toggle super-cool/pull down																										
"diP": increase display intensity	"diP": increase display intensity																										
"din": decrease display intensity	"din": decrease display intensity																										
"CFA": toggle °C and °F	"CFA": toggle °C and °F																										
	"PoF": ERC power ON/OFF																										
	"HoL": enter holiday mode																										
	"inF": enter info menu																										
<p>"b1L" Default PoF</p>		<p>Upper left button: Button 2 Config (short press)/b2C Button 2 Config (long press)/b2L</p>																									
<p>"b2C" Default dEF</p>		<p>Upper right button: Button 3 Config (short press)/b3C Button 3 Config (long press)/b3L</p>																									
<p>"b2L" Default inF</p>		<p>Lower right button: Button 4 Config (short press)/b4C Button 4 Config (long press)/b4L</p>	<p>NOTE: Your assignments may not be shown on the printed buttons. We advice to use this functionality together with the fully integrated mounting model only.</p>																								
<p>"b3C" Default tP</p>																											
<p>"b3L" Default ECo</p>																											
<p>"b4C" Default tn</p>																											
<p>"b4L" Default Lig</p>																											
<p>"PS1" Min. 0 Max. 999 Default 0</p>		<p>Password level 1 / PS1 Password Level 2 / PS2 Password Level 3 / PS3 These assign passwords to the three levels of access. The password is a three-digit number. Access levels are Shop, Service and OEM.</p>																									
<p>"PS2" Min. 0 Max. 999 Default 0</p>		<p>You may not therefore have access to change all the passwords. Passwords are entered by using the up and down arrow buttons. Danfoss advises against using passwords which are easy to remember or enter, for example 111, 222, 123 etc.</p>																									
<p>"PS3" Min. 0 Max. 999 Default 0</p>		<p>NOTE: When accessing the controller with 3 wrong password in a sequence ERC will automatically block access for 15 minutes.</p>																									

Ser		Service information settings
		<p>The parameters in the following section are READ ONLY and cannot be changed by the user. They provide information for technicians and OEM users.</p> <p>NOTE: the only parameters that can be configured are: "oEL", "oEn", "oEH". These parameters allow OEMs to enter their own product code.</p>
	"ACt"	Accumulated Comp. run time
	"AEt"	Accumulated ERC up time
	"uAC"	Voltage value Current main power supply voltage.
	"ouS"	DOs Status Current relay open closed status.
	"rL1"	Relay 1 counter Thousands of cycles of compressor relay since manufacture.
	"int"	Interval Counter Compressor run time since last defrost.
	"dnt"	Defrost time counter Duration of last defrost cycle [min].
	"Snu"	Serial number Serial number given at manufacturing.
	"Fir"	SW version Danfoss software version number.
	"HAr"	HW version Danfoss hardware version number.
	"onL"	OrderNoLow Danfoss order code number.
	"onH"	OrderNoHigh Danfoss order code number.
	"oEL"	OEM code Low
	"oEn"	OEM code Middle
	"oEH"	OEM code High
	"PAr"	Parameter version OEM parameter version number [requires EKA copy key update].
	"CHd"	Manufacturing date Programme date WWY: week number and year number (2010-19).
	"SFC"	Set as Default Resets all parameters to last good OEM settings.
	"Ctt"	Condenser Temp Temperature of the condensor sensor.
	"Et1"	Evaporator1 Temp Temperature of the evaporator sensor1.
	"AuS"	AUX Temp. Temperature of the AUX sensor. invisible.
	"att"	Raw Sair Temp

Display messages	
"unP"	Device is unprogrammed (relay output is lockt)
"Prg"	Device has not finished programming (relay output is lockt)
"SC"	Device is in pull-down mode (super-chill)
"dEF"	Device is defrosting

Troubleshooting

Problem	Probable cause	Remedy
Compressor does not start	Waiting for compressor delay timer Defrost in progress Line voltage to compressor too low or too high	Check CoP->CSt Check CoP ->Pot /Pod Check dEF ->dit, dot Check CoP->uLi, uLo, uHi
Defrost does not start	Controller in pull down mode	Defrost might be delayed during pull down Check parameter Pud->Pdi
Alarm does not sound	Alarm delayed	Check ALA->Htd, Abd Check Pud->Pdd
Display alternates between condenser and temperature	Condenser too hot	Clean condenser Check Con ->CAL, CbL
Display alternates between high and temperature	Temperature too high	Check ALA->HAt
Display alternates between low and temperature	Temperature too low	Check ALA -> LAT
Display shows "dEF"	Defrost in progress	Check diS ->SdF

Alarm code	Trigger	Automatic clearance	Outputs	Comments
"Hi"	Air temperature is higher than "ALA->Hat" for "ALA->Htd"	User configured	Blink "Hi" with the highest temperature; If configured: cut in alarm relay, beep the buzzer	High temperature alarm
"Lo"	Air temperature is lower than "LAT" for "Ltd"	User configured	Blink "Lo" with the lowest temperature. If configured: cut in alarm relay, beep the buzzer	Low temperature alarm
"Con"	Condenser temperature is too high or too low	User configured	Blink "Con". If configured: cut in alarm relay, beep the buzzer	Condenser alarm
"uHi"	Line voltage is higher than "Cop->uHi"	Always	Blink "uHi". If configured: cut in alarm relay, beep the buzzer	High voltage alarm
"uLi"	Line voltage is lower than "Cop->uLi"	Always	Blink "uLo". If configured: cut in alarm relay, beep the buzzer.	Low voltage alarm
"LEA"	Compressor continuous running for more than "ALA->LEA"	Always	Blink "LEA". If configured: cut in alarm relay, beep the buzzer	Leakage alarm
"E01"	"S1" error	Always	Blink "E01". If configured: cut in alarm relay, beep the buzzer	"S1" sensor failure (short or open)
"E02"	"S2" error	Always	Blink "E02". If configured: cut in alarm relay, beep the buzzer	"S2" sensor failure (short or open)

Typical applications

Glass Door Merchandiser, No-frost freezer/sub-zero cooler

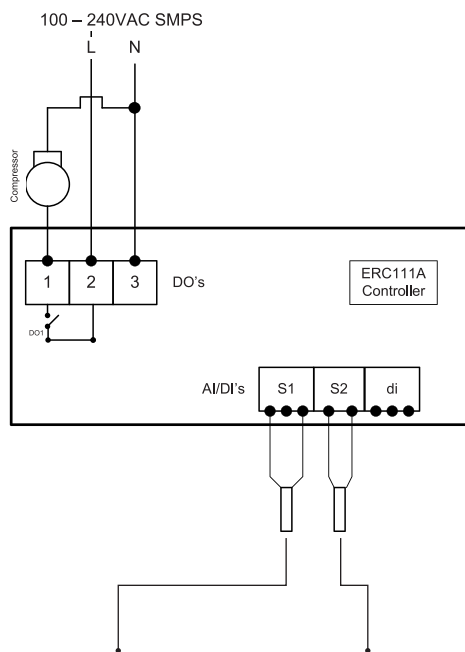
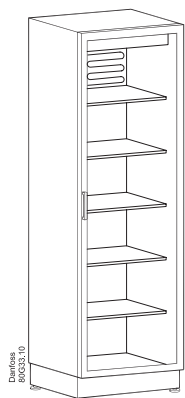

ERC 111	
ERC 111, Red LED, without buzzer	080G3230
ERC 111, Blue LED, without buzzer	080G3231

Temperature Sensor for Cabinet Temperature Control	
PVC Standard Connector type 3-pole	
470 mm	077F8751
1000 mm	077F8757
1500 mm	077F8761
2000 mm	077F8765
2200 mm	077F8767
3000 mm	077F8769
3500 mm	077F8723
6000 mm	077F2019

Temperature Sensor for Condenser Temperature Control	
PVC Standard Connector type 2-pole	
1000 mm	077F8786
1500 mm	077F8790
2000 mm	077F8794
3000 mm	077F8798
6000 mm	077F2029

Sensor placement

Control sensor

The control sensor must always be connected and is used for controlling the cut-in and cut-out of the compressor according to the set point. The sensor is also used for the displayed temperature.

Control sensor

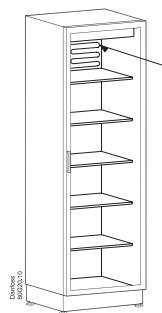

Vertical coolers with fan

Most common placement is in the return air to the evaporator. The sensor can be placed close to the fan – even when the fan is pulsed during compressor OFF periods: the updating of the temperature is blocked when the fan is stopped and only updated when the fan has been running for a while, so that the heat from the fan does not affect the temperature reading.

For applications sensitive to sub-zero temperatures, sensor placement in the evaporator outlet air can be considered.

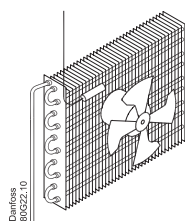

Vertical freezers with fan

Placement in the return air or in the freezer compartment.

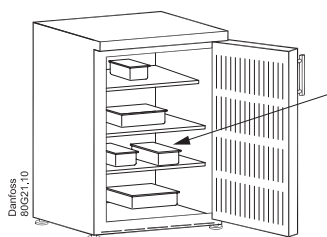

Coolers without fan

The best results are normally obtained when the sensor is placed at the side-wall, 10 cm from the back and approximately at 1/3 from the bottom or where the evaporator ends.

The control sensor must always be connected and is used for controlling the cut-in and cut-out of the compressor according to the set point. The sensor is also used for the displayed temperature.

Condenser sensor

The condenser sensor is used to protect the compressor against high pressure when the condenser is blocked or the condenser fan fails.

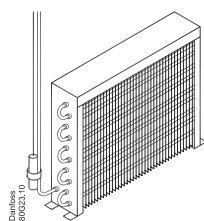

Placement of sensor

Place the sensor at the liquid side of the condenser. Use a metal bracket or metal tape to ensure good thermal conductivity. Be sure that the cable does not pass hot spots at the compressor or condenser that exceeds 80°C.

Application Matrix

ERC 111		Output	Input		
Application	Type	DO1	S1	S2	Di
Standard beverage cooler	ERC 111	Comp	Control	Defrost or condenser	-
Out-door beverage cooler	ERC 111	Comp	Control	Defrost or condenser	-
CFF refrigerator	ERC 111	Comp	Control	Defrost or condenser	-
CFF freezer static evaporator	ERC 111	Comp	Control	Condenser	-

NOTE:

- Select only one function per input, e.g. defrost or condenser sensor.
- Make sure that the accessory you select has a matching connector to the input, e.g. a sensor for input "S2" must have "S2" connector.
- Condenser sensor are optional and can be omitted.

ENGINEERING
TOMORROW

