

ENGINEERING
TOMORROW

Danfoss

User manual

Monitor a wide variety of refrigerants with your **Multi-zone gas monitor**

Easily programmed to monitor a variety of gases and independent leak, the evacuation levels may be designated for each zone

Index

1.0	Introduction	6
1.1	About this manual	6
1.2	Warning and caution conventions	6
1.3	Safety precautions	6
1.4	Key external hardware components	8
1.5	Functional overview	9
1.5.1	General description	9
1.5.2	Communications options	9
1.5.3	Understanding monitoring levels	9
1.5.4	Response to the presence of multiple refrigerants (HGM Only)	9
1.5.5	Suggested location of sampling points	10
1.5.6	Locating a remote display (optional)	11
1.6	Specifications	12
2.0	Installation	14
2.1	Installation considerations	14
2.1.1	Warnings and cautions	14
2.1.2	Inspection	14
2.1.3	Location of the monitor	14
2.1.4	Mounting instructions	15
2.2	Connecting gas sample lines	16
2.2.1	Overview	16
2.2.2	Tubing considerations	16
2.2.3	Connecting purge line	17
2.2.4	Connecting exhaust Line	17
2.2.5	Connecting sample intake lines	17
2.2.6	Installing an optional splitter kit	18
2.2.7	Connecting the water trap	18
2.3	Interior components	19
2.4	Electrical wiring	19
2.5	Connecting communications devices	20
2.5.1	Remote display module (RD) connection	20
2.5.2	Integrating with building management systems	21
2.5.3	Larger integrated systems	21
2.5.4	Changing terminator switch settings	22
2.5.5	Personal computer	22
2.6	Terminating multiple monitors	23
2.7	Connecting to a building management system	23
2.8	PC software	24
2.8.1	Operation	24
2.8.2	Saving and sending programs	25
2.8.3	Trend data	25
2.8.4	Converting the TREND text tile to an Excel file	26
2.8.5	Saving and printing screens and logs	26
2.8.6	USB type laptops	26
2.9	Optional current loop interfaces	26
2.9.1	Optional 4-20 mA DC outputs	26
2.9.2	4-20 mA DC connections	27
2.10	Connecting external alarms	29
2.10.1	Overview	29
2.10.2	Connection	29
3.0	Setup programming	31

3.1	Initial power up	31
3.2	Data display screen	31
3.3	Navigating to the 1st setup screen	31
3.4	Navigating to the 2nd setup screen	32
3.4.1	Location	32
3.4.2	Number of zones installed	32
3.4.3	Alarm acknowledge mode	32
3.4.4	Audible alarm	33
3.4.5	Zone hold	33
3.4.6	Detection limit	33
3.4.7	Loop mode	33
3.4.8	Loop2 factor	34
3.4.9	Re-zero mode	34
3.5	Navigating to the 3rd setup screen	34
3.5.1	Overview	34
3.5.2	Baud rate	35
3.5.3	Node address	35
3.5.4	Password	35
3.6	Additional service features	35
3.6.1	Service timeout	36
3.6.2	DET digipot	36
3.6.3	Node address	36
3.6.4	Sensor temperature coefficient (for factory use only)	36
3.6.5	Password	37
3.6.6	Acquiring temperature coefficient (for factory use only)	37
3.6.7	IR digipot	37
3.7	Establishing the CO ₂ sensor baseline	37
4.0	General operation	38
4.1	Functional overview	38
4.2	The zone setup screen	38
4.2.1	Location	38
4.2.2	Gas/refrigerant type	38
4.2.3	Distance + EXH	39
4.2.4	Temp @ zone	39
4.2.5	Current detection reading	39
4.2.6	Log interval	39
4.3	Navigating to the 2nd zone setup screen	39
4.3.1	Leak level	40
4.3.2	Spill level	40
4.3.3	Evacuation level	40
4.3.4	Re-setting the peak PPM value	40
4.4	Alarms	40
4.4.1	Functional overview	40
4.4.2	Responding to alarms	41
4.4.3	Alarm detail screen	41
4.4.4	Acknowledging alarms	42
4.4.5	Silencing an alarm	42
4.4.6	Clearing the alarm event log	43

4.5	System faults	43
4.5.1	Functional overview	43
4.5.2	Navigating to the fault screen	44
4.5.3	Critical faults	44
4.5.4	Reset to factory default settings	45
4.5.5	Clearing system faults	46
4.5.6	Viewing fault log	46
4.5.7	Viewing flow log	47
4.6	The trend screen	47
4.6.1	Navigating to the trend screen	47
4.7	The calibration screen	48
4.7.1	Overview	48
4.7.2	Navigating to the calibration screen	48
4.7.3	Calibration procedure (HGM and AGM only)	48
4.7.4	Adjusting calibration factor (HGM and AGM only)	49
4.7.5	CO ₂ atmospheric concentration	49
4.7.6	Programming new gases (HGM only)	50
4.8	Zone hold mode	51
4.9	The diagnostic screen	51
4.9.1	Navigating to the diagnostic screen	51
4.9.2	Diagnostic screen overview	52
5.0	Maintenance	53
5.1	Troubleshooting	53
6.0	APPENDIX A	55
7.0	APPENDIX B	56
7.1	Overview	56
7.2	MODbus RTU Protocol	56
7.3	Multi-zone MODbus RTU operation	56
7.3.1	Overview	56
7.3.2	Protocol details	56
7.3.3	Multi-zone monitor polling	57
7.3.4	Network topologies	57
7.3.5	Key comm protocol parameters	58
7.3.6	Summary of registers	58
7.3.7	System data register 0x0010 (16 Dec) (R/W, 54 Bytes)	59
7.3.8	Status register 0x0011 (17 Dec) (R/W, 10 Bytes)	60
7.3.9	Fault code table	60
7.3.10	Zone data register 0x12xx (R/W, 78 Bytes)	61
7.3.11	Alarms and alarm acknowledge	62
7.3.12	Date time register 0x0015 (21 Dec) (R/W, 14 Bytes)	63
7.3.13	Sensor data register 0x0016h (22 Dec) (R, 82 Bytes)	63
7.3.14	Release zone hold register 0x0017h (23 Dec) (W, 10 Bytes)	64
7.3.15	Hold zone register 0x0018h (23 Dec) (W, 10 Bytes)	64
7.3.16	Multi-zone hold mode	64
7.3.17	Fault log register 0x1900-01 (6400-6401 Dec) (R, 302 Bytes)	64
7.3.18	Flow log register 0x001F (31 Dec) (R, 142 Bytes)	65
7.3.19	Alarm log register 0x1A00-02 (6656-58 Dec) (R, 582 Bytes)	65
7.3.20	Service mode register 0x001B (27 Dec) (W, 10 Bytes)	65
7.3.21	Release service mode 0x001C (28 Dec) (W, 10 Bytes)	65
7.3.22	Multi-zone service mode	66
7.3.23	PPM register 0x001E (30 Dec) (R, 32 Bytes)	66
7.3.24	Zone log registers 0x3xyy (R, 1502 Bytes)	66
7.3.25	MODbus exception responses	67
7.3.26	MODbus gas enumeration	67

8.0	APPENDIX C	68
9.0	Replacement parts & optional accessories	70

1.0 Introduction

1.1 About this manual

To assure operator safety and the proper use of the monitor please read this manual. It provides important information on the installation, operation, maintenance, and servicing of the monitor and display module.

If you have a working knowledge of your gas monitor, you will find this manual useful as a reference tool. If you are new to the use of gas monitors, this document is educational in the principles of gas detection and the proper operation of this device.













1.2 Warning and caution conventions

When used in this manual or as labeled on the gas monitor, the following hazard symbols and/or associated words are defined as follows.

	WARNING: this symbol and/or the use of the word WARNING indicates a potential hazard associated with the use of this equipment. It calls attention to a procedure, practice, condition, or the like, which if not correctly performed or adhered to, could result in death or serious injury
	WARNING: this symbol and/or the use of the word WARNING indicates a potential hazard from electrical shock. It calls attention to a procedure, practice, condition, or the like, which if not correctly performed or adhered to, could result in death or serious injury
	CAUTION: this symbol and/or the use of the word CAUTION indicates a potential hazard associated with the use of this equipment. It calls attention to a procedure, practice, condition, or the like, which if not correctly performed or adhered to, could result in minor or moderate injury
	IMPORTANT: the use of the word IMPORTANT in this manual calls attention to a procedure, practice, condition, or the like, which if not correctly performed or adhered to, could result in incorrect performance of or damage to the equipment and may void the warranty

1.3 Safety precautions

	WARNING: this instrument has not been designed to be intrinsically safe for use in areas classified as hazardous locations. For your safety, DO NOT use it in hazardous (classified) locations
	WARNING: this is NOT a safety device. Some gases which this instrument can detect may be combustible/flammable. When properly configured, this instrument is designed to alarm at concentrations that are lower than the explosive limit of the gas. As such, it is the buyer's responsibility to initiate an immediate planned response to any gas leaks as soon as they are detected. This equipment should NEVER be used to measure or sample gases at or above their respective lower explosive limits
	IMPORTANT: the gas monitor uses a universal power supply that is capable of accepting inputs of 100 to 240VAC, 50/60Hz. The monitor's power consumption is 20Watts. It is highly recommended that the monitor be connected directly to the AC power source, preferably on its own circuit with UPS or surge protection
	WARNING: A switch or circuit breaker must be included in the building installation. The switch must be in close proximity to the monitor and within easy reach of the operator. The switch must be clearly marked as the disconnecting device for the equipment

	<p>WARNING: under no circumstances should the monitor be operated without connection to a protective ground. Doing so poses a potential shock hazard and is also a violation of electrical safety standards applicable to this type of equipment</p>
	<p>WARNING: do not operate this equipment in the presence of flammable liquids, vapors, or aerosols. Operation of any electrical instrument in such an environment constitutes a safety hazard</p>
	<p>WARNING: it is imperative that the exhaust port on this instrument be properly vented as described in this manual. Failure to do so may constitute a safety hazard</p>
	<p>WARNING: extreme care should be exercised when accessing the interior of the monitor. Only qualified electrical maintenance personnel should make connections and perform adjustments. Always remove AC power before opening the monitor's enclosure</p>
	<p>WARNING: the protection provided by the monitor may be impaired if the monitor is used in a manner not specified by Danfoss. Modifications to this monitor, not expressly approved, will void the warranty</p>
	<p>WARNING: do not continue to use this equipment if there are any symptoms of malfunction or failure. In the case of such occurrence, de-energize the power supply and contact a qualified repair technician or the nearest Danfoss Service Center.</p>
	<p>WARNING: this device uses type "F" fuses ("F1" and "F2") rated at 1.0A, 250VAC. Replace ONLY with Danfoss-approved fuses</p>
	<p>WARNING: electrical installation should be performed by a certified electrician, and must comply with all applicable NEC/CEC and local electrical safety codes</p>
	<p>IMPORTANT: use ONLY the provided knockouts for electrical and communications wiring. Drilling into the box will void the warranty</p>
	<p>IMPORTANT: this device is classified as Installation Category II, Pollution Degree II, as defined by UL</p>
	<p>IMPORTANT: this device is designed for operation at or below an altitude of 6.562ft (2,000 m). Do not operate this device above this altitude limit</p>
	<p>NOTE: to clean the outside of the case use a dry cloth. To avoid shock hazard and/or equipment damage, DO NOT use soap and water</p>

1.4 Key external hardware components

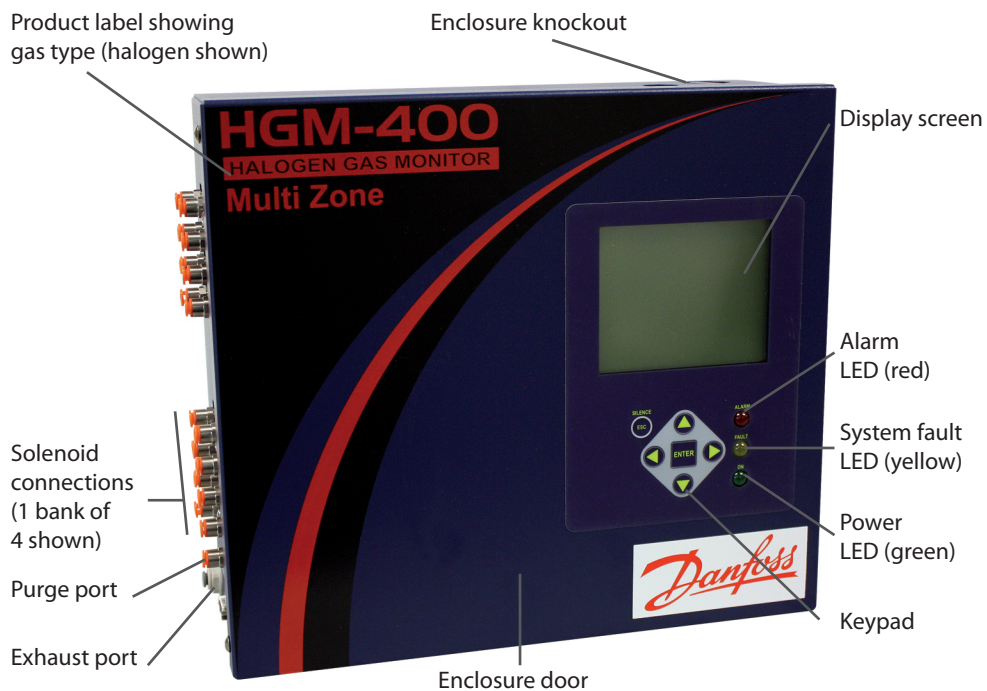

 **NOTE:** mounting cutouts are located on the back of the monitor, and are visible from inside the Multi-zone monitor. A mounting template is also shipped with the monitor. For mounting information, (see 2.1.4 "Mounting instruction")

1.5 Functional overview

1.5.1 General description

Gas monitors are specified to support compliance to federal, state and local safety codes governing emissions. Avoiding significant loss reduces equipment replacement costs, maintains equipment efficiency, promotes safety, and protects the environment.

The Danfoss Multi-zone monitor provides continuous monitoring of gas levels in up to 16 separate test zones. The instrument is easily programmed to monitor a variety of gases (dependent on particular model) and independent leak (small), spill (medium), and evacuation (large) levels may be designated for each zone. The instrument also retains a log of previous readings that can be easily accessed for analysis.

An audible alarm and front panel indicators are provided to signal alarm and fault conditions, and relay contacts are provided that can be used to trigger external alarm devices in the event of a system fault, or if a leak (small), spill (medium), or evacuation (large) level of gas is detected. The system also may be fitted with an optional two-channel 4-20mA current loop board for connection to remote monitoring equipment.

The Multi-zone monitor requires only minor periodic maintenance such as the occasional replacement of filters. The monitor incorporates active diagnostics that continuously check the system for proper operation. A front panel indicator is provided to alert an operator of system malfunctions, and fault codes are generated that enable the user to identify the cause of the fault.

1.5.2 Communications options

The Multi-zone monitor features full two-way communications via an RS-485 interface. MODbus RTU is the communications protocol standard. The instrument can be connected directly to a Building Management System or it may be operated as a stand-alone system.

An RS-232C port is also provided for connection to a PC. This enables the monitor to be setup from a personal computer. (See 7.0 "Appendix B").

1.5.3 Understanding monitoring levels

Effective use of this instrument requires an understanding of what constitutes reasonable alarm set points for the types of gas being monitored. Manufacturers define allowable exposure levels and threshold limit values in units of parts per million (ppm). In a good "tight" installation these background levels will be acceptably low and often do not require corrective action. You can reduce nuisance alarms and needless service calls if the alarm levels are set at practical limits. Danfoss has developed recommended monitoring refrigerant gas levels based on compliance to ANSI/BSR ASHRAE 15-2007 and ASHRAE Safety Code 34-2007. (See 6.0 "Appendix A").

Setting the monitor at these recommended alarm levels will satisfy the needs of most users. However, the ppm levels generated by system leaks into the environment are greatly influenced by the volume of air in the sampling area, air circulation, size of the leak, distance to the monitoring point, and a host of other variables. In some cases the set points may need to be adjusted either up or down to achieve effective monitoring.

1.5.4 Response to the presence of multiple refrigerants (HGM Only)

The HGM-400 multi-zone is a refrigerant level monitor, not a gas analyzer. You must program the monitor to test for a specific refrigerant, and it will only return accurate concentration readings for that particular refrigerant. If a leak occurs of another refrigerant gas type, the monitor may return incorrect readings.

Most applications only require detection of a single refrigerant and the problems that are associated with monitoring multiple gases are rarely an issue. If there is a possibility of multiple refrigerants leaking in the same sampling zone, then you should carefully consider which refrigerant compound you program the unit to monitor.

1.5.5 Suggested location of sampling points

At the point of a leak the gas is nearly pure. As the gas is dispersed into the air, the gas molecules diffuse, causing a dilution of the original concentration. The monitor measures the concentration at the sample collection point. Therefore, if the termination of the collection line is not at the exact point of the leak, the unit will read a diluted mixture of the gas and air.

It should also be noted that gases of interest are heavier than air and tend to collect below the point of a leak. Therefore a sample taken near the floor will have a greater concentration of gas than that collected above the source of a leak. Therefore, sampling points should be located as close as possible to the sources of potential leaks. If this is impractical, then the alarm set points should be adjusted for that zone to compensate for the dilution of the gas. Sample inlet filters should be mounted 12-18" (30.5-45.7cm) above the floor.

DO NOT block any of the zones, unused zones may be disabled by setting the distance parameter to zero feet in the zone setup screen.

The Multi-zone monitor should be centrally located in the mechanical room and be readily accessible for easy visual monitoring and servicing. The combined length of sample tubing plus exhaust tubing should not exceed 1200 ft (366m) for any zone. The fresh air purge line should draw from an area that does not contain any gas. The exhaust line should run to an outside location if possible.

	<p>NOTE: the combined length of the purge line and the exhaust line cannot exceed 500ft</p>
---	--

Ideally, two to three pick up points spaced around each chiller will provide sufficient coverage. It may be necessary to perform a smoke test of the mechanical room to determine the best locations. The smoke test provides the pattern of air currents present in the mechanical room.

The Multi-zone monitor should be kept dry, when used in a wet or humid area, it is highly recommended to use the optional water stop accessory to avoid internal damage.

1.5.6 Locating a remote display (optional)

The Remote display module should be mounted outside of the mechanical room, or just inside the room's doorway if the first option isn't possible. This is the "split architecture design" for safety of the operator. The Remote display can be located up to 4500ft (1372m) from the Multi-zone monitor. The Remote display is the man machine interface by which you program the Multi-zone, acknowledge alarms and observe conditions inside of the mechanical room. Note that there are two additional alarm relay contacts in the Remote display that can be programmed to alarm on leak, spill, evacuate, fault, or monitor on conditions.

MZ/RD gas leak monitor placement in a mechanical room

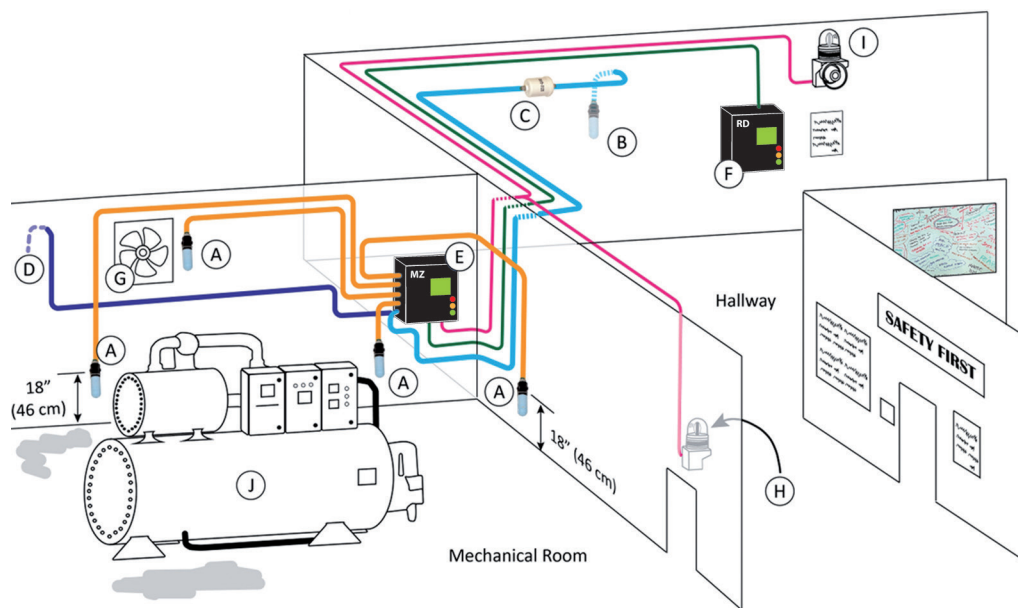

- A Sample inlet pickup poin.
- B Outside pickup point away from refrigerant gas (fresh air for Multi-zone purge cycle).
- C Charcoal filter.
- D Exhaust air (to outside).
- E Multi-zone gas monitor.
- F Remote display (outside mechanical room).
- G Exhaust fan.
- H Horn/strobe alarm outside mechanical room door.
- I 2nd auxiliary horn/strobe remote alarm.
- J Chiller.

 **NOTE:** the pickup points located on the floor in the above illustration are examples for refrigerants which are heavier than air. Placement of pickup points should be determined based on characteristics of the gas being monitored and ambient conditions of the sampling area.
(Air=28.9 g/mole, CO₂=44.0 g/mole, NH₃=17.0 g/mole, and halogens = 100+ g/mole)

1.6 Specifications

HGM-MZ Specifications	
Product type	Multiple refrigerant gases and multiple area monitoring system for low level continuous monitoring of CFC, HCFC and HFC refrigerant gases used in most commercial refrigeration systems. System design supports compliance to the refrigerant monitoring requirements of ANSI/BSR ASHRAE 15-2007 and ASHRAE Safety Code 34-2007
Sensitivity	All gases 1 ppm
Measuring range	All gases 0 to 10.000 ppm
Accuracy ¹	±1 ppm ±10% of reading from 0-1000 ppm (R11, R22, and R113 ±10 ppm ±15% of reading 0-1000 ppm)
Gas library	CFC: HFP, R-11, R-12, R-113, R-114, R-502; HFC: R125, R-134a, R236FA, R245Fa, R32, R-404a (HP62), R-407a, R-407c (AC9000), R-410a (AZ20), R422a, R422d, R427a, R-507 (AZ50), R-508b (SUVA95); HCFC: R-123, R-124, R21, R-22, R227, R-23, R-401a (MP39), R-402a (HP80), R 402b (HP81), R-408a, R-409a, R-500, R-503; Halon: H1211, H1301, H2402; Other: FA188, FC72, H1234YF, N1230, R424A, R426A, R438A, CUSTOM.

AGM-MZ Specifications	
Product type	The AGM-MZ provides multiple area monitoring system for low level continuous monitoring of Ammonia gases used in most commercial systems
Sensitivity	20 ppm
Measuring range	25 to 10,000 ppm
Accuracy ¹	±10 ppm ±10% of reading from 0-10,000 ppm
Gas library	Ammonia (NH ₃)/R-717

CO ₂ -MZ Specifications	
Product type	The CO ₂ -MZ provides multiple area monitoring for low level continuous monitoring of carbon dioxide gases used in most commercial systems. System design supports compliance to the gas monitoring requirements of ANS/BSR ASHRE 15-1994
Sensitivity	10 ppm
Measuring range	300-8.000 ppm
Accuracy ¹	±5 PPM ±5% of reading from 300-1000 ppm, ±10% of reading from 1001-3000 ppm
Gas library	Carbon Dioxide (CO ₂)/R-744

¹ At reference environmental conditions (25°C, 45% RH non-condensing, 1 ATM)

General Multi-zone Specifications	
Coverage	4 point standard, expandable to 16 points in 4 point increments
Detector type	Infrared non-dispersive
Front panel	3 Indicator lights: <ul style="list-style-type: none"> • Green: monitor is powered ON. LED glows during normal operation; flashes when unit is in warm-up mode • Red: alarm. LED flashes when any point has exceeded the alarm setting • Yellow: fault. LED flashes when there is a system fault

General Multi-zone Specifications	
Size (HxWxD)	12.23" x 13.7" x 4.96" (31.06cm x 34.80cm x 12.60cm)
Weight	15lbs. (6.8kg)
Sampling mode	Automatic or manual (hold)
Re-zero	Auto or on zone change
Response time	5 to 315 seconds - depending on air line length and number of zones
System noise	Less than 40dB(A) @ 10ft (3m)
Monitoring distance	1.200ft (366m) maximum for combined length of sample + exhaust tubing (each zone)
Conditioned signal	Dual optional 4-20mA DC isolated outputs. Channel 1 = zone area, Channel 2 = PPM
Alarms	Four SPDT alarm contacts rated 2A at 250VAC (inductive) 5A at 250VAC (resistive). Three are assigned to PPM level alarms, one assigned to system faults
Communications	Full two-way communications with Remote Display Module or Building Management System via RS 485 serial interface. RS-232C communications port standard
Power safety mode	Fully automatic system reset. All programmed parameters retained
Operating temperature	32 to 122°F (0 to 50°C)
Ambient humidity	5% to 90% RH (non-condensing)
AC power	100 to 240VAC, 50/60Hz, 20W
Certification	UL 61010-1, CAN/CSA 22.2 No. 61010-1 & CE Mark
Warranty	2 years from date of shipment
Altitude limit	6.562ft (2,000m)
Sensor life	7-10 years

2.0 Installation

2.1 Installation considerations

2.1.1 Warnings and cautions

	<p>WARNING: explosion hazard! Do not mount the Multi-zone monitor in an area that may contain flammable liquids, vapors, or aerosols. Operation of any electrical equipment in such an environment constitutes a safety hazard</p>
	<p>WARNING: shock hazard! Always disconnect AC power before working inside the monitor</p>
	<p>CAUTION: drilling holes in the Multi-zone enclosure may damage the unit and will void the warranty. Please use the knockouts provided for electrical connections</p>
	<p>CAUTION: the Multi-zone monitor contains sensitive electronic components that can be easily damaged. Do not touch nor disturb any of these components</p>

2.1.2 Inspection

The Multi-zone monitor has been thoroughly inspected and tested prior to shipment from the factory. Nevertheless, it is recommended that the monitor be re-checked prior to installation. Inspect the outside of the enclosure to make sure there are no obvious signs of shipping damage. Open the enclosure and inspect the interior of the monitor for loose components that may have become dislodged during shipment. If damage is discovered, please contact the nearest Danfoss Service Center for assistance.

2.1.3 Location of the monitor

The Multi-zone monitor should be centrally located in the facility and should be easily accessible for visual monitoring and servicing. Combined length of the intake sample line and the exhaust line cannot exceed 1200ft (366m) in length, but it is important to remember that sampling cycle time is proportional to the total number and length of individual sample lines.

Dirt, grease, and oils can adversely affect the operation of the Multi-zone monitor. The monitor should be installed out of direct sunlight in a clean, dry area that is not subject to temperature or humidity extremes. Installation of the monitor in a mechanical room is acceptable provided reasonable environmental conditions exist. If there is a question, consider installing the unit outside of the mechanical room in a cleaner area of the facility.

	<p>NOTE: the mounting location of the monitor should allow it to be easily accessible for visual monitoring and servicing</p>
--	--

2.1.4 Mounting instructions

	<p>NOTE: the Multi-zone monitor should be installed plumb and level and securely fastened to a rigid mounting surface</p>
--	--

The enclosure utilizes keyhole mounting brackets designed for ¼ inch fasteners. Locate the four screws as shown in the diagram below or by using the provided mounting template. Allow the screw heads to protrude approximately ¼ inch.

Multi-zone Monitor mounting specifications

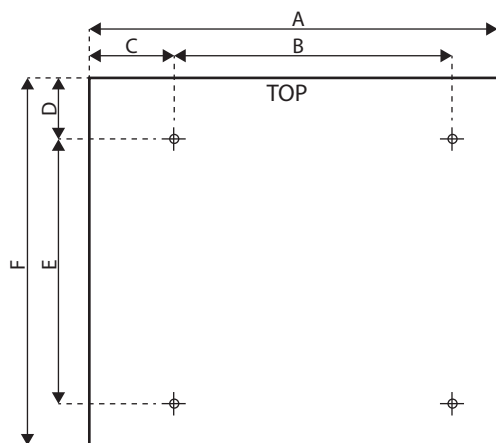

Mounting instructions

Four ¼ inch (6.35mm) fasteners are required to mount the Multi-zone enclosure. Allow approximately ¼ inch (6.35mm) of each fastener to remain exposed.

The enclosure can slide directly on to the screw heads for mounting. Verify position of enclosure on fasteners and tighten all fasteners.

$$A = 13 \frac{9}{16}'' = 13.56'' = 34.44\text{cm} \quad D = 2 \frac{1}{32}'' = 2.03'' = 5.16\text{cm}$$

$$B = 9 \frac{5}{16}'' = 9.31'' = 23.65\text{cm} \quad E = 8 \frac{55}{64}'' = 8.86'' = 22.50\text{cm}$$

$$C = 2 \frac{55}{64}'' = 2.86'' = 7.26\text{cm} \quad F = 12 \frac{1}{4}'' = 12.25'' = 31.12\text{cm}$$

Hold the monitor flat against the mounting surface and allow it to slide down, engaging the screw heads in the keyhole slots of the mounting brackets. Adjust the screws as necessary to hold the monitor securely against the mounting surface.

2.2 Connecting gas sample lines

2.2.1 Overview

Individual gas sample lines are run from the Multi-zone monitor to each area of the facility to be monitored. Additionally, a purge line is installed to provide clean air for resetting the infrared zero baseline.

All air, sample, and purge line connections are located on the left side of the enclosure.

(See the illustration below).

Multi-zone monitor side view

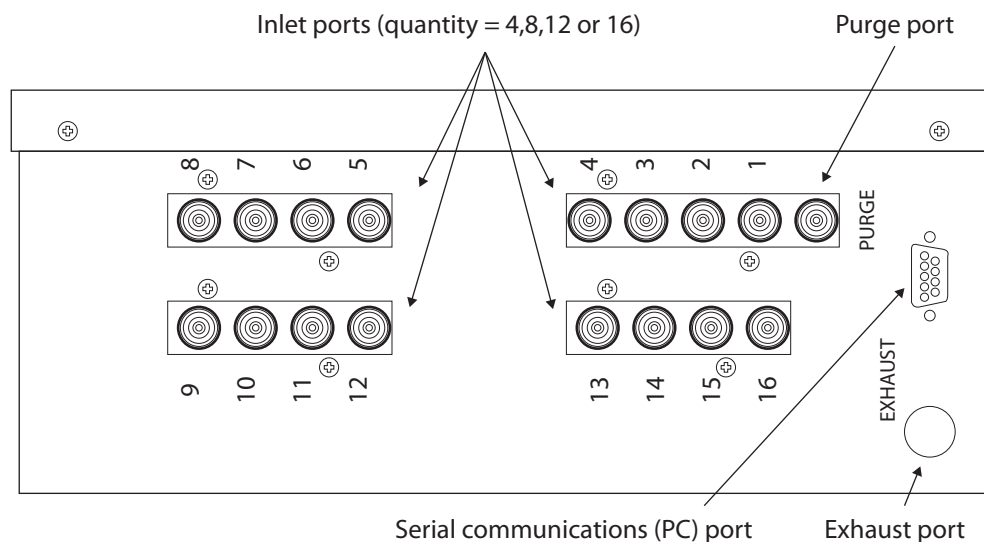

2.2.2 Tubing considerations

Use ¼" (6.35mm) outside diameter (0.040" or 1.016mm wall) flex tubing for all air lines or equivalent. The tubing should be clean and free of residual moisture or other contaminants. The tubing should be cut cleanly with a sharp knife and care should be taken not to distort the tubing end. To connect the air lines to the monitor simply push the tubing firmly onto the connector. To remove a line, press the plastic ring on the connector with one hand, then withdraw the tube with your other hand.

(See the image below).

Using PTC connectors: connecting (left) and disconnecting (right)

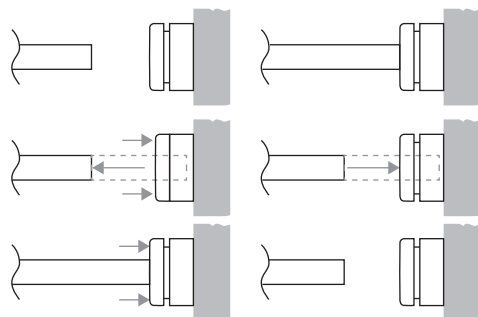

The Multi-zone monitor uses push-to-connect (PTC) style connectors.

To insert sample lines, firmly push the appropriate tubing into the hole in the center of the connector until it seats in the connector. Refer to the figures at the left.

To remove tubing from a PTC connector, push and hold the spring-loaded collar inwards, then simultaneously withdraw the tubing. Refer to the figures at the right.

All tubing bends should have a radius of no less than 5" (12.7cm) to ensure proper airflow. If kinks or obstructions occur in any of the air lines the instrument may not function properly.

2.2.3 Connecting purge line

A purge line is an intake line that is required to draw fresh air into the instrument and should not exceed 300ft (91.44m) in length. It is advisable to terminate the purge line outdoors, provided the input is not exposed to rain, snow, ice, exhaust fumes, or other airborne contaminants.

If an outdoor installation is impractical, the line should be run to an area inside the facility that you are certain is not contaminated with ambient gas. If this is not possible, an optional charcoal filter assembly can be used with the Halogen Gas Monitor to filter refrigerant from the purge line. It may be mounted adjacent to the monitor. A line-end filter should be attached to the end of the purge line when the charcoal filter is not used.

Note that the charcoal filter option must NOT be used in ammonia or CO₂ applications.

	<p>IMPORTANT (CO₂ Only): because CO₂ is present in ambient air, the purge line MUST BE run outside, away from any known sources of CO₂ gas. An atmospheric CO₂ concentration value can be manually entered by the user in the CAL screen. (See 4.7.5 "CO₂ Atmospheric concentration").</p>
--	---

2.2.4 Connecting exhaust Line

An exhaust line can be used when it is required to vent gas samples away from the instrument and should not exceed 300ft (91.44m) in length. The exhaust line should terminate in a location that is completely isolated from the purge line termination point and other areas of the facility that will be monitored. Ideally this line should terminate outdoors in a location that is not exposed to the elements. This line does not require a line-end filter.

If the exhaust line terminates outside the building, position the tubing so that no water or moisture can enter it.

2.2.5 Connecting sample intake lines

The Multi-zone monitor is designed to accommodate up to 16 separate sample intake lines. The standard configuration of the unit includes one manifold of 4 intake connectors and 1 purge connector. Additional manifolds can be easily installed to increase monitoring capacity (field installation kit, and 4 zone line end filter kit).

Sample intake lines can be up to 1.200ft (366m) when no exhaust tubing is used, otherwise, the combined length of the sample line and the exhaust line cannot exceed 1.200ft (366m). All line terminations should be positioned to reduce the possibility of mists, aerosols, oil, water, dust, or other contaminants being drawn into the instrument. A line-end filter should be attached to the end of each sample intake line. Line-end filters should be placed 12" to 18" (30.5cm to 45.7cm) above the floor.

	<p>IMPORTANT: DO NOT block any of the zones. Unused zones may be disabled by setting their length parameter to zero in the zone setup screen.</p>
--	--

Depending on type of use and location of lines, the end-of-line water stop filter assembly can be used to prohibit moisture from entering the intake lines. Three end-of-line water stop filters are supplied with a standard unit.

Place the end of the intake line into the blue receiver of the end of line water stop and tighten sufficiently.

	<p>NOTE: only one filter assembly, either the line-end filter or end-of-line water stop, should be used for each line.</p>
--	---

Please (see 1.5.5 "Suggested location of sampling points") to learn more about where to place the ends of the sample intake lines.

2.2.6 Installing an optional splitter kit

Splitter kits are made available which allow the Multi-zone unit to take gas sample readings from several sample points while utilizing just a single zone. These kits are designed for use ONLY in confined/defined spaces with high potential for leaks, such as food cases, cold rooms, refrigeration rack rooms, etc.

Multi-zone gas monitor's 2 way and 3-way splitter kits are available as optional accessories.

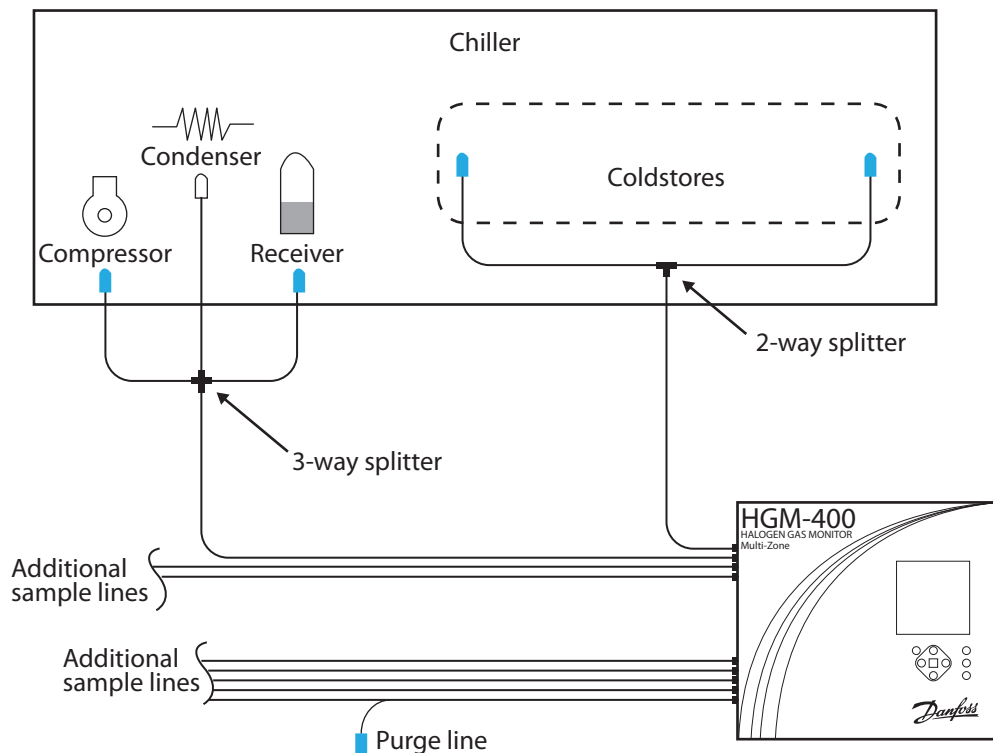

2.2.7 Connecting the water trap

The water trap is an optional accessory for applications that result in water or condensation frequently entering the intake lines. This is available in a manual style trap which is manually emptied once it has become filled. Install the water trap close to the unit for the most effective results. The intake line may be cut where the user finds appropriate (preferably close to monitor).

Each side of the intake line should be inserted into the receivers on either side of the water trap. Secure tightly, a replacement filter for the water trap is available and is replaced by unscrewing the clear plastic cup of the water trap, pulling the filter directly out (do not unscrew), and inserting the new filter into place. Replace the cup of the water trap, if desired, an optional mounting bracket may be used to secure the water trap in place.

	<p>NOTE: the termination filter or end-of-line water stop filter should be used, regardless of the presence of a water trap</p>
	<p>IMPORTANT: extreme or humid temperatures may cause water to condense in the tubes. A water trap is highly recommended for use in these scenarios</p>

2.3 Interior components



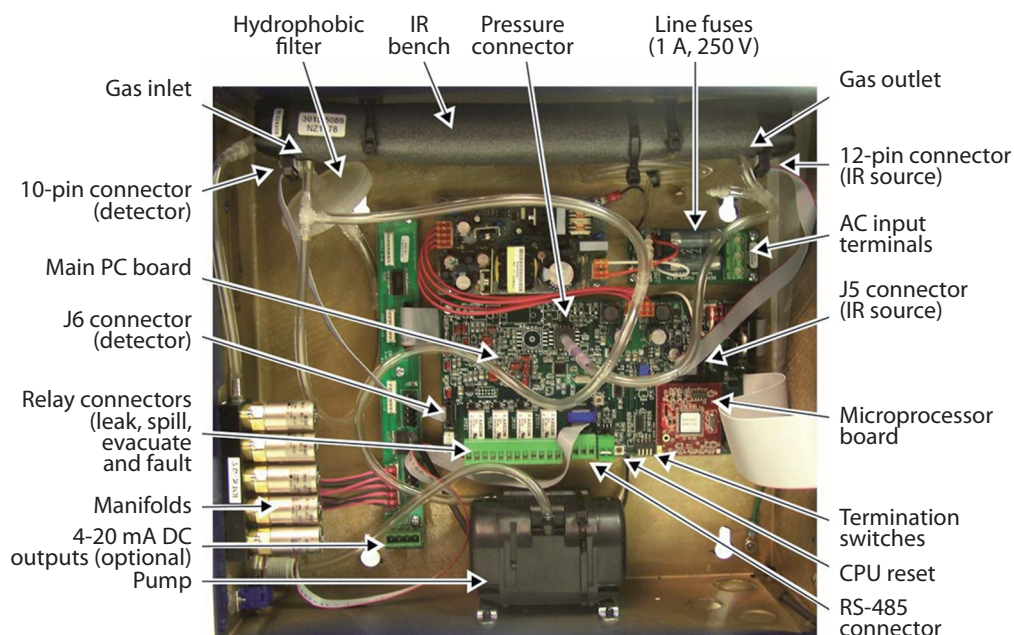

Multi-zone monitor interior components



 **NOTE:** the plastic cable ties surrounding the air pump are to ensure safe handling during shipping. Please remove before operation, reinstall a plastic cable around the air pump if the unit is shipped to Danfoss for service or repair. This prevents damage during shipping

2.4 Electrical wiring

The Multi-zone monitor uses a universal power supply that is capable of accepting inputs of 100 to 240VAC, 50/60Hz. The monitor's power consumption is 20W, it is highly recommended that the monitor be connected directly to the AC power source, preferably on its own circuit. The AC power connection should be completed with UL listed 3 conductor wire (minimum 16 AWG), rated 300VAC at 105°C. Locate a convenient service knockout and install electrical conduit in the typical manner. Locate the AC input terminals and ground stud on the inside of the monitor, secure the incoming AC power neutral (white/blue) and live (black/brown) wires to the LINE 1 and LINE 2 terminals. Using the supplied crimp-on ring terminals, washers, and nuts, connect the incoming AC power ground wire (green) to the monitor's AC input ground stud, and then install a separate wire between the ground stud and the GND terminal.

	<p>WARNING: electrical installation should be performed by a certified electrician, and must comply with all applicable NEC/CEC and local electrical safety codes</p>
	<p>WARNING: copper conductors for connection to supply mains must be made in accordance with NEC/CEC and local codes</p>
	<p>WARNING: the AC power ground wire must first be connected to the monitor's ground stud. Under no circumstances should this monitor be operated without a protective ground. Doing so poses a potential shock hazard, and is also a violation of electrical safety standards applicable to this type of equipment.</p>
	<p>IMPORTANT: drilling holes in the Multi-zone enclosure may damage the unit and will void the warranty. Please use the knockouts provided for electrical connections</p>

A switch or circuit breaker rated 1.0A, 250VAC must be attached to the monitor's AC power leads. This switch must also be located in close proximity to the monitor, and be in easy reach of the operator. This switch should also be clearly marked as the monitor's main AC disconnect device. The circuit breaker or switch must disconnect all current-carrying conductors (e.g., live and neutral).

Multi-zone AC input power and ground connections

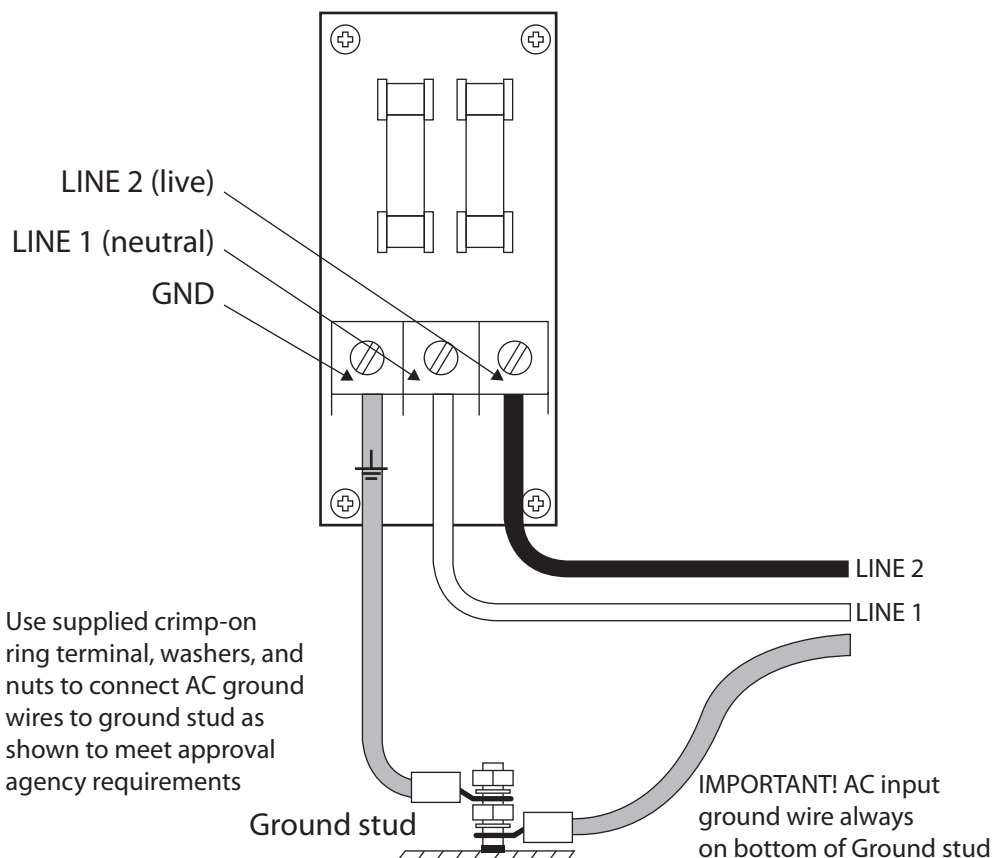

2.5 Connecting communications devices

2.5.1 Remote display module (RD) connection

The Multi-zone is connected to the optional Remote display using a shielded twisted pair instrument cable, the maximum distance between the farthest Multi-zone and Remote display is 4500ft.

Use any of the remaining service knockouts to gain access to the interior of the monitor, the RS-485 communications wiring between the Multi-zone and Remote display must be connected in the following manner:

1. Locate the RS-485 connector in the Multi-zone, (see figure "Monitor interior components").
2. Connect one lead of a twisted shielded pair to the "B" connection point, note the wire colour.
3. Connect the second wire to the "A" connection point, note the wire color.
4. Connect the ground to the "GND" connection point.
5. Locate the RS-485 connector marked "TO MONITORS" in the Remote display. This connector is located on the bottom of the Remote display PC board, second from the right.
6. Run the wire to the Remote display and connect the twisted shielded pair to the RS-485 "TO MONITORS" connector using the same color code as used on the Multi-zone.

2.5.2 Integrating with building management systems

The Multi-zone may be connected directly to a Building Management System using a shielded twisted pair cable. The cable from the Building Management System is connected to the RS-485 connector inside the Multi-zone monitor. MODbus RTU is the standard communications protocol.

Use any of the remaining service knockouts to gain access to the interior of the monitor:

- locate the RS-485 connector and remove it from the circuit board
- secure the wire leads to the connector orienting them as shown in the diagram below
- check to make sure that the polarity matches the wiring to the Building Management System

When you are through securing the connections, carefully plug the connector back onto the circuit board.

2.5.3 Larger integrated systems

You may also connect the Multi-zone monitor to a Building Management System through a Remote Display, in this case, first connect the Multi-zone to the Remote display as described above, then follow the instructions in the Communications Connections section of the Remote display manual for information on how to connect the Remote display to a Building Management System.

RS-485 connector

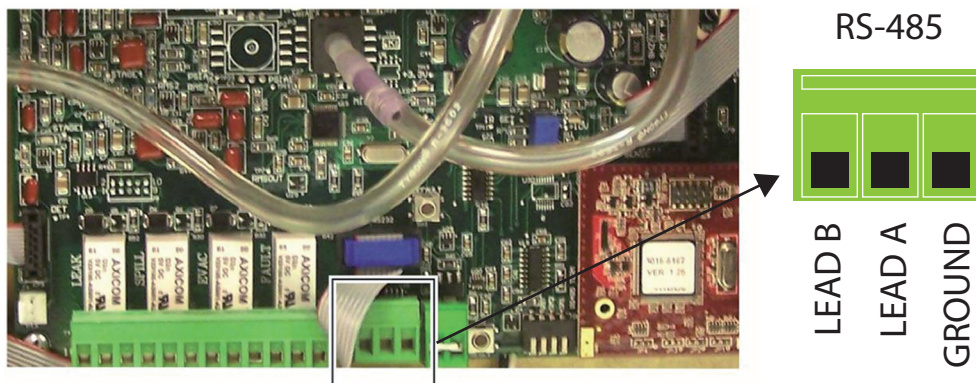

2.5.4 Changing terminator switch settings

The terminator switch is shipped from the factory in the "OUT" position (no termination), this is the correct setting if the Multi-zone is to be installed in the middle of a network, if the Multi-zone monitor is connected as a single device or if it is the last device on the network chain, the terminator must be moved to the "IN" position.

Locate switch #4 and determine its position, if it must be moved, slide the switch to the appropriate position. Note that switches 1-3 are for service use.

Termination switches

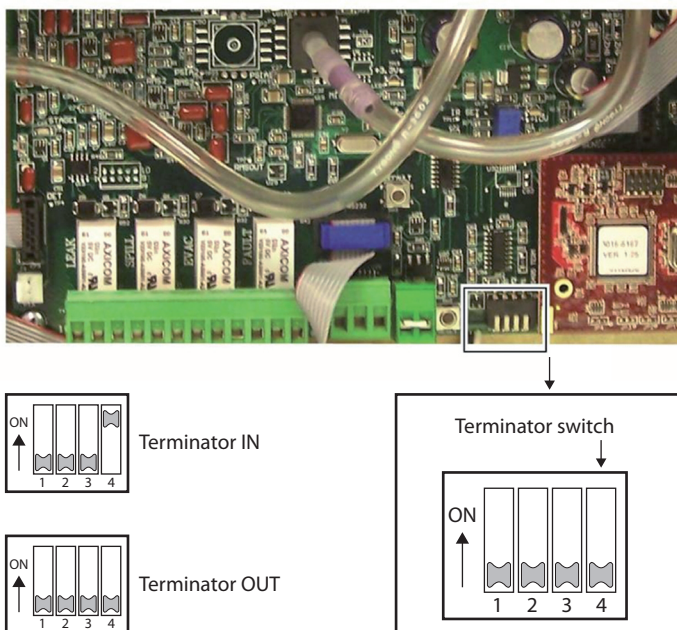

2.5.5 Personal computer

The Multi-zone may be connected to a personal computer using the RS-232 interface on the left side of the enclosure. Software will be provided upon request.

	<p>NOTE: (see 2.8 "PC Software")</p>
--	---

2.6 Terminating multiple monitors

Termination settings for a network of multiple monitors and a remote display

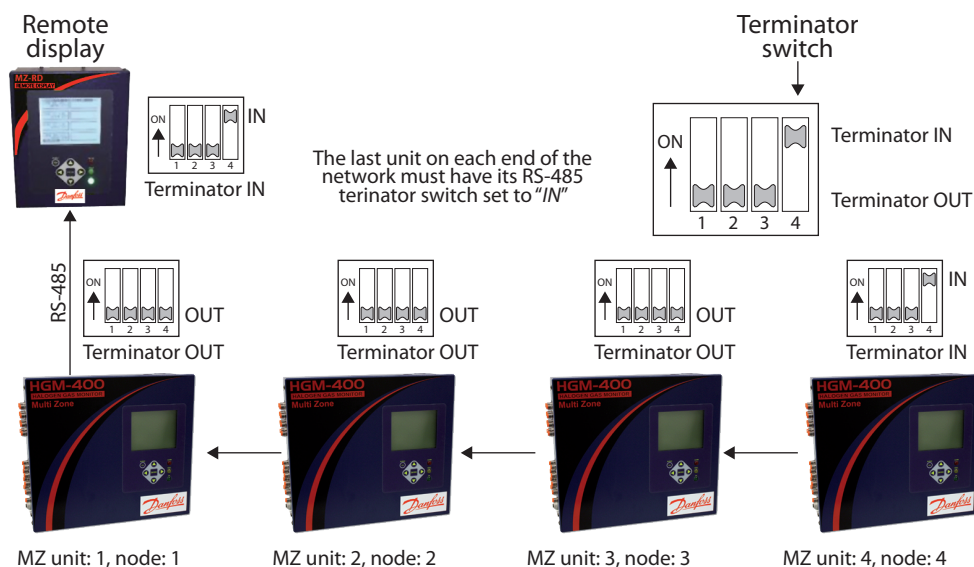

	NOTE: for multiple Multi-zone with Remote Display, the last Multi-zone or Remote display on either end of the network must have its terminator in the "IN" position, and all other units must have their terminators in the "OUT" position
	IMPORTANT: extreme or humid temperatures may cause water to condense in the tubes, a water trap is highly recommended for use in these scenarios

2.7 Connecting to a building management system

The Multi-zone monitor may be connected to a Building Management System via the RS-485 connector. The node address on each Multi-zone monitor may be set from 1 to 15 in order to identify itself to the Building Management System.

	NOTE: building Management Systems set to a 0 or 1 address both respond to messages from the Remote display as address 1, therefore you should not have a unit set to 0 and another set to 1 on the same network
--	--

If the Multi-zone network is connected directly to a Building Management System it may not be connected to the RD. However, the Remote display has two communications ports, an "upstream" port (labeled BMS) and a "downstream" port (labeled TO MONITORS). A Building Management System node may be connected to the upstream Remote display port while the downstream Remote display port talks to the Multi-zone monitors, in this case, the Building Management System is talking "through" the Remote display to the Multi-zone monitors, but not physically on the Multi-zone/RD network.

	NOTE: user must have two (2) dedicated ports to successfully complete the required setup
--	---

Termination settings for multiple monitors connected to a Building Management System (two trunks)

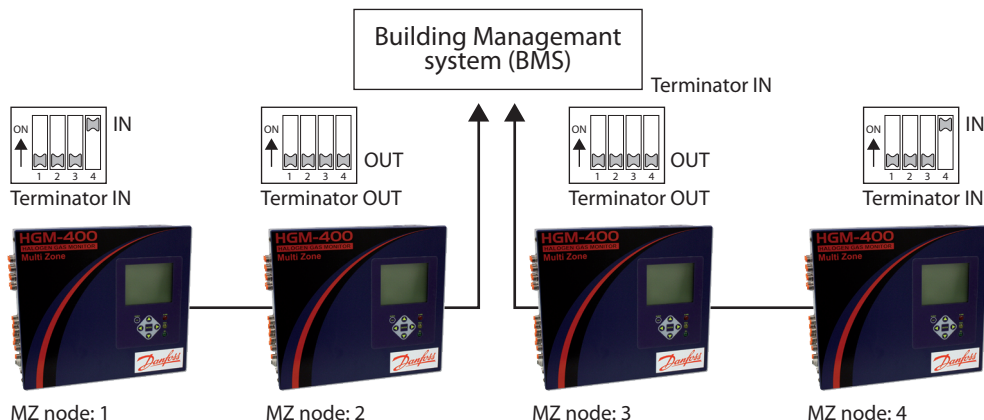

Termination settings for multiple monitors connected to a Building Management System (daisy chain)

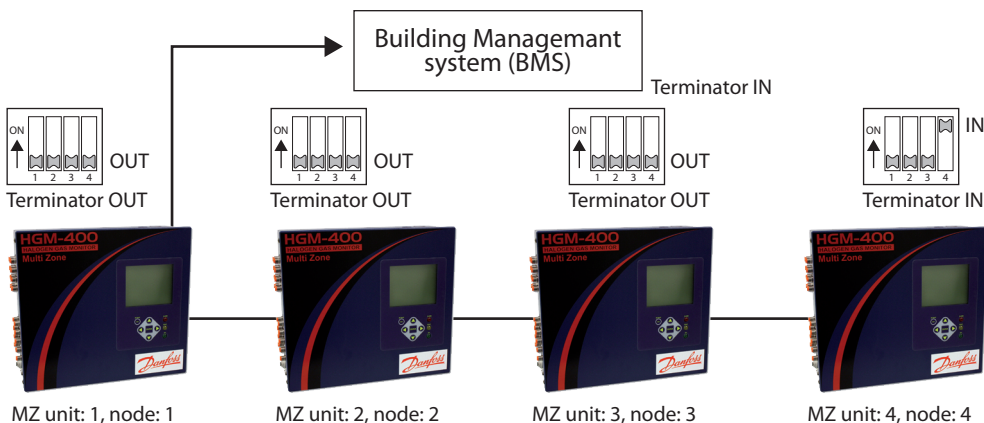

2.8 PC software

2.8.1 Operation

	<p>NOTE: the Multi-zone is compatible with HGM-400 PC software version 1.52 and higher, however, calibration data can only be edited on the front panel of the Multi-zone, not through the PC software or RDM units</p>
	<p>NOTE: The PC software is not compatible with 64-bit (or newer) computers</p>

	<p>NOTE: The PC software uses COM1 by default, therefore, the interface cable should be connected to the port configured as COM1 on the PC. Also, no other software drivers or devices in the computer may control COM1 when the Multi-zone software is in use, alternatively, COM2 (for example) may be used by adding a space and the number 2 to the command line as follows: <code>C:\pc2HGM.exe 2</code>.</p> <p>When using a USB to serial converter, be sure it has been mapped to COM1 or COM2. The connection is made through a standard "straight through" serial port connection. A three-wire connection is used (RXD, TXD, and GND), no hardware flow control is used, the Multi-zone software automatically configures COM1 to match the Multi-zone RS-232 communications parameters</p>
	<p>NOTE: occasionally, the laptop connection will not connect properly and only two beeps are heard and the program times out, to resolve this, disconnect the RS-232 cable and cycle power ON the Multi-zone and the laptop, after both are operational, connect the RS-232 cable and start the software program</p>

1. Apply power to Multi-zone monitor and allow it to warm up. Note that on CO₂ models, a "Clearing Purge Line" message is displayed for approximately 2.5 minutes before warm up begins.
2. Connect RS-232 interface cable to the PC and RS-232 port on the Multi-zone monitor.
3. Insert software disk into the PC.
4. Open the Multi-zone software using Windows Explorer.
5. Upon start up, the program will immediately attempt to download data from the Multi-zone, as indicated by several beeps.

Navigate using your PC keyboard:

- use the **UP, DOWN, LEFT, and RIGHT** arrow keys to navigate through the screen options
 - use the **ENTER** key to select options
 - use the **ESC** key to go back one step
6. From the EDIT menu, select SYSTEM. The monitors' LOCATION becomes highlighted, press **ENTER** to move to the TAG area. Use the **Backspace** key to remove the existing tag, Enter a new tag, Press **ENTER** to return to LOCATION and select the next item to be addressed. Note that you cannot change the "SN" or "FIRMWARE" items. Press the **ESC** key to return to the menu bar.
 7. From the EDIT menu, select ZONES. Select a specific zone to identify and set parameters, when REFRIGERANT is selected (Halogen Monitor), scroll through the gas library to locate and select the gas type for that zone.
 8. Setting the Alarms, select EVAC LEVEL, use the **Backspace** key to clear previous setting. Type in the new PPM level, use the same method to set the spill level and leak level.
 9. To close or bypass a zone, set the DISTANCE to 0ft.

	<p>IMPORTANT: when a modified parameter (zone, system, or calibration) is sent to the Multi-zone monitor, please wait for the computer software to indicate that the download is complete before continuing with any further edits</p>
--	---

2.8.2 Saving and sending programs

- When saving to your computer, the program will automatically add ".cfg" to the filename you have entered.
- To send a saved program to the Multi-zone, open the program and connect the PC to the Multi-zone. From the monitor, select SEND SETUP and press **ENTER**, the saved program will be sent to the Multi-zone.

2.8.3 Trend data

	<p>NOTE: creating a trend data file must be done while connected to the Multi-zone</p>
--	---

From the computer, select GET TREND DATA and select the zone that you want to trend and press **ENTER**. The trend data will appear in a list format, press **ENTER** again to access the file name screen.

Type the file name in for that particular zone and press **ENTER**.
The file will be saved as a text file that can be converted to an Excel file or printed as is.

	<p>NOTE: the TREND file must be saved zone by zone, with a filename per zone</p>
--	---

2.8.4 Converting the TREND text tile to an Excel file

Open Excel and the desired file, select "*Delimited*" format and "*Space*" as the delimiter. Select "*General*" as the column data format. The text file will display as an Excel file, when saving, change the file name extension to "*xls*".
Comments or notes may be added to this file as needed and saved.

2.8.5 Saving and printing screens and logs

Open the software while connected to the Multi-zone. After the software receives the program, open the desired screen (e.g., software screen, alarm log, fault log, diagnostic screen, etc.).
Use the **ALT** and **PRINT SCREEN** key combination on the PC keyboard to capture the image and paste it into a Word document, save and print.

2.8.6 USB type laptops

Some laptops have USB ports and no RS-232 9-pin ports. A USB-to-serial converter or PCMCIA-to-serial converter will be required if a PCMCIA slot is available. You will be required to purchase a PCMCIA card that provides an RS-232 output. This is necessary for Windows Vista and higher versions. We recommend the PCMCIA card manufactured by:

SEALEVEL SYSTEMS, INC
www.sealevel.com

Reference part numbers 2105R USB-to-RS-232 or PC-SIO-232 PCMCIA card.
A "*straight through*" RS-232 cable and a DB25-to-DB9 adapter will be required to connect the laptop to the HGM-MZ.

2.9 Optional current loop interfaces

	<p>NOTE: the two-output, current loop interface is an option that MUST be ordered separately</p>
--	--

2.9.1 Optional 4-20 mA DC outputs

Upon installation of the optional 4-20mA DC Interface Board, the Multi-zone has the capability of providing dual 4-20mA DC scrolling current loop outputs for connection to external monitoring devices (e.g., a local loop-powered display or a building management system [BMS]).

	<p>IMPORTANT: loop outputs are powered internally. Do not use an external power supply as this can damage the loop card</p>
--	--

	<p>NOTE: optional remote loop-powered displays are available to view the 4-20mA outputs</p>
--	--

The interfaces are set up as follows:

- Loop 1 indicates zone area.
- Loop 2 indicates PPM.

The 4-20mA outputs are scaled to correspond to individual zone numbers and PPM concentrations. Scaling for the 16 (maximum) zone numbers is fixed (see table below). The default scaling for the PPM concentrations provides a 0 1000 PPM range for the 4-20mA output, although it can be adjusted through the LOOP2 FACTOR option in the SYSTEM SETUP screen. (See tables below).

Loop 1 = Zone	
Output	Zone
4 mA DC	n/a
5 mA DC	1
6 mA DC	2
7 mA DC	3
8 mA DC	4
9 mA DC	5
10 mA DC	6
11 mA DC	7
12 mA DC	8
13 mA DC	9
14 mA DC	10
15 mA DC	11
16 mA DC	12
17 mA DC	13
18 mA DC	14
19 mA DC	15
20 mA DC	16

Loop 2 = PPM (Default: 0.016 mA DC = 1 PPM)	
Output	PPM (Default)
4 mA DC	0 PPM
5 mA DC	63 PPM
6 mA DC	125 PPM
7 mA DC	188 PPM
8 mA DC	250 PPM
9 mA DC	313 PPM
10 mA DC	375 PPM
11 mA DC	438 PPM
12 mA DC	500 PPM
13 mA DC	563 PPM
14 mA DC	625 PPM
15 mA DC	688 PPM
16 mA DC	750 PPM
17 mA DC	813 PPM
18 mA DC	875 PPM
19 mA DC	937 PPM
20 mA DC	1000 PPM

2.9.2 4-20 mA DC connections

External devices are connected to the Multi-zone monitor using a shielded dual twisted pair cable. Use any of the remaining service knockouts to gain access to the interior of the monitor, locate the dual 4-20mA DC output connector (see below) and remove it from the circuit board, secure the wire leads to the connector orienting them as shown in the diagram below.

Check to make sure the polarity matches the wiring at the external device, when you are through securing the connections, carefully plug the connector back onto the circuit board.

	<p>NOTE: the ground connections of the 4-20mA DC output connector are common</p>
	<p>NOTE: the 4-20mA DC output connector are SIGNAL OUT ONLY. DO NOT APPLY POWER</p>
	<p>NOTE: it is highly recommended that a current loop isolator is used when connecting to the 4-20 outputs. Danfoss recommends the "Dataforth DSCL 21 Loop powered isolator DIN mount". More detailed information can be found at www.dataforth.com</p>
	<p>NOTE: when one or both current loop outputs are not used, install a jumper wire between the ground and the unused loop terminal(s) to prevent the system from generating a current loop fault</p>

Optional dual 4-20 mA DC output board for the Multi-zone

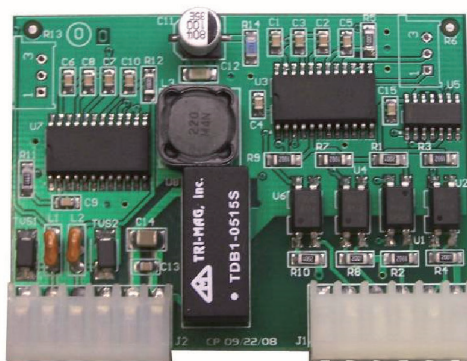

	<p>CAUTION: the loop outputs have isolated grounds, therefore the cable shield should be terminated at the receiver and not the Multi-zone monitor. The signal for both current loops must be returned to the Multi-zone monitor</p>
--	---

Optional dual 4-20 mA DC output board and connector

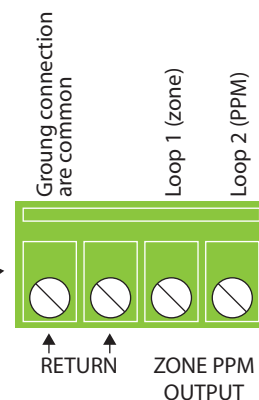
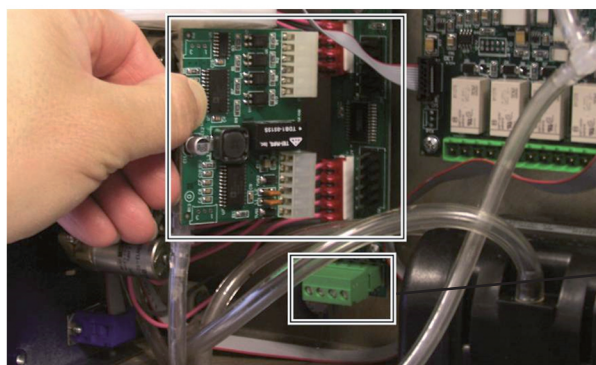

2.10 Connecting external alarms

2.10.1 Overview

The Multi-zone monitor includes four SPDT relays whose contacts are rated 2A at 250VAC (inductive) and 5A at 250VAC (resistive). These relays are used for the connection of external alarm devices that are activated when the relay is energized.

The relays are factory assigned to energize under the following conditions:

- Relay #1 Leak Alarm Point 100 ppm.
- Relay #2 Spill Alarm Point 300 ppm.
- Relay #3 Evacuate Alarm Point 500 ppm.
- Relay #4 Fault System Fault Event.

2.10.2 Connection

Use the conduit or any of the remaining service knockouts to gain cable access to the interior of the monitor, locate the relay connector, (see Figure "Multi-zone Monitor Interior Components") and remove it from the circuit board. Secure the leads to the connector orienting them as shown in the diagram below, when you are through securing the connections, carefully plug the connector back onto the circuit board.

Multi-zone monitor relay connector

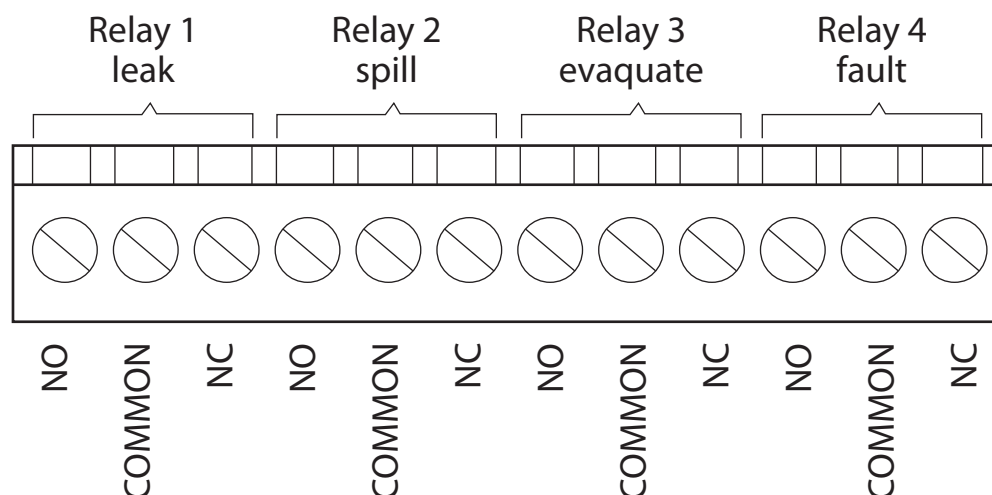

Each relay may be connected as normally open (NO), or normally closed (NC).

The relay contacts are rated 2A at 250VAC (inductive) and 5A at 250VAC (resistive).

Power for the alarm devices connected to the relay contacts may be supplied by an external 24VDC power source or the monitor's AC input terminals. In the first wiring diagram, power to this device is being tapped off the monitor's AC input. In the second wiring diagram, power is supplied from an external power source.

Jumper the "Live/Positive" line of an external power source (DC devices) or the monitor's AC input (AC devices) to the "Common" terminal on the relay connector.

Connect the "Live/Positive" end of the strobe or horn to the "NO" terminal of whichever level of alarm is appropriate for the application.

For protection, install an in-line fuse of the appropriate size and design for the external alarm device being used.

The other end of the strobe or horn is connected to the "Neutral/Negative" leg of the external power source (DC devices) or monitor's AC input (AC devices).

Typical AC external alarm relay 1 wiring

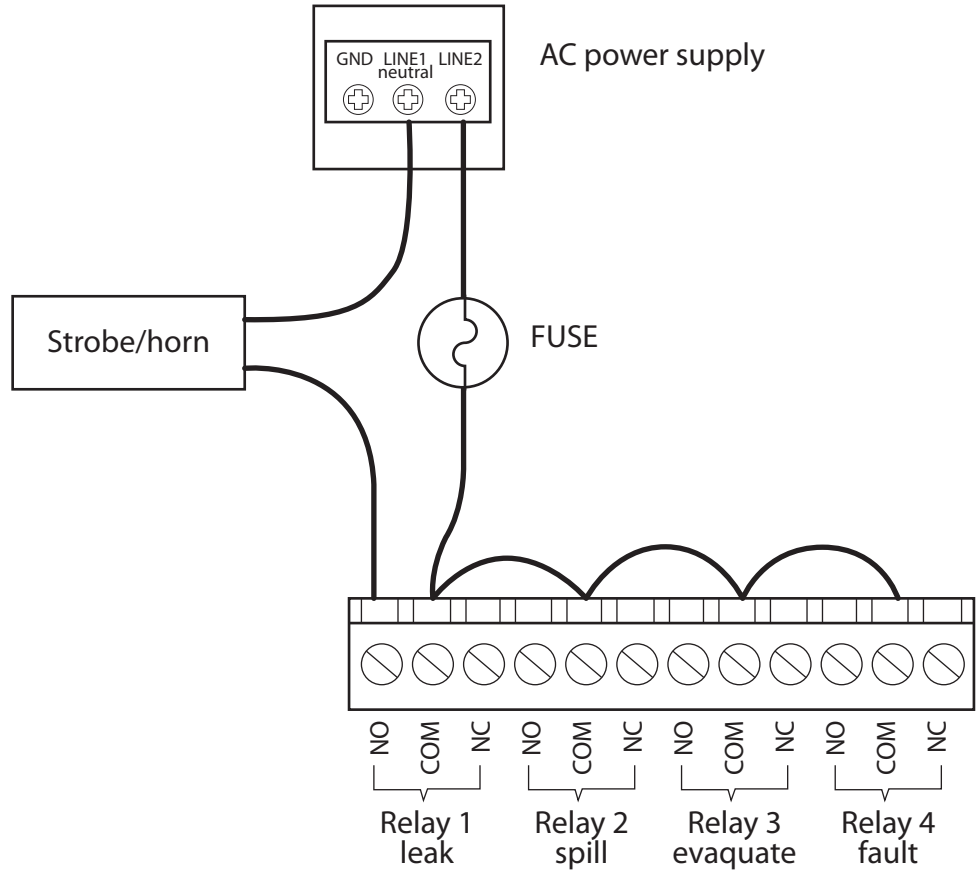

Typical DC external alarm relay 1 wiring

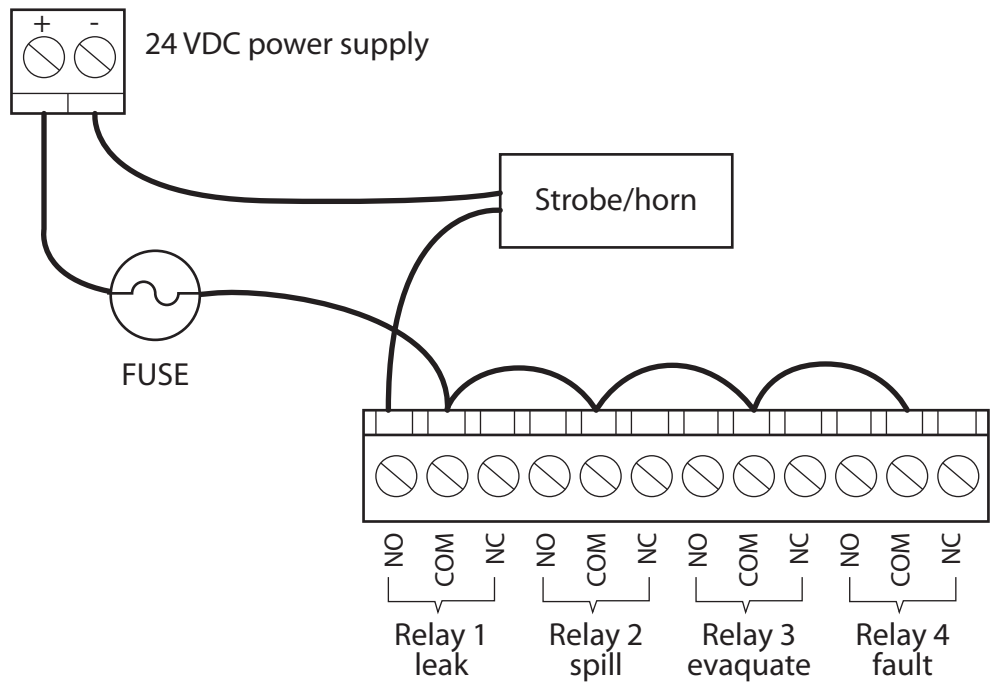

3.0 Setup programming

3.1 Initial power up

When the Multi-zone monitor is powered up, all front panel LEDs will illuminate and a splash screen will appear, displaying the monitor's firmware version level. Note that on CO₂ models, a "Clearing Purge Line" message is displayed for approximately 2.5 minutes before warm up begins. After a moment, the "Warm Up" screen will be displayed and the green MONITOR ON light will blink.

After a 15 minutes warm up cycle, the MONITOR ON light will glow steadily and the "Data Display" screen will be displayed. (See 8.0 "Appendix C").

3.2 Data display screen

Data display screen and front panel keypad

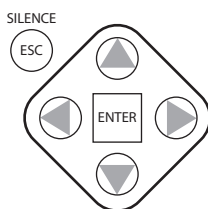
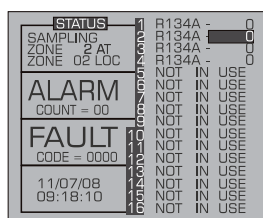

Use the **ARROWS** key for multi-directional movement in making selections and moving the cursor

Use the **ENTER** key to initiate and complete a selection

Use the **ESC** key to go back during programming or to silence an alarm in alarm mode

3.3 Navigating to the 1st setup screen

From the Data Display Screen, press the **UP** or **DOWN** arrow key. **SETUP** will be highlighted in the first box, press **ENTER** to select this option and display the **SETUP** screen (see below).

System setup screen #1

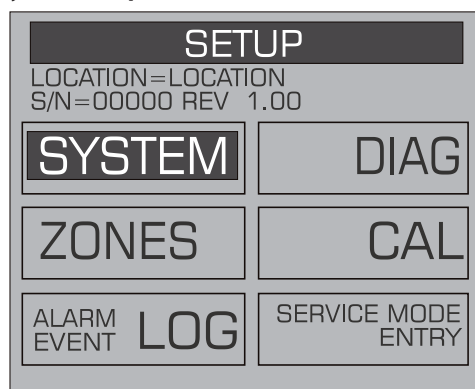

3.4 Navigating to the 2nd setup screen

From system setup screen #1, select the SYSTEM option to go to system setup screen #2. Select the **ESC** key to return to the system setup screen #1.

HGM system setup screen #2

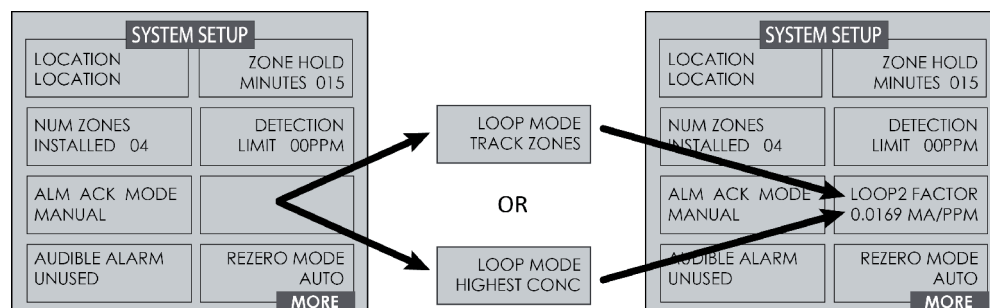

3.4.1 Location

This is the name you assign to the Multi-zone monitor to identify its location. It may have up to 12 alphanumeric characters.

1. Press the **ENTER** key to adjust the setting.
2. Use the **LEFT/RIGHT** cursor keys to move across the entry field and the **UP/DOWN** cursor keys to modify the individual characters.
3. Press **ENTER** to accept the new entry or **ESC** to revert to the previous setting.

3.4.2 Number of zones installed

IMPORTANT: do not change the number of zones to deactivate unused zones. Changing the number of installed zones is only necessary when manifold blocks are added or removed. Go to the individual zone that you wish to disable and set its distance to zero

1. Press the **ENTER** key to adjust the number.
2. Use the **UP/DOWN** cursor keys to modify the number (must be 4, 8, 12, or 16).
3. Press **ENTER** to accept the new number or **ESC** to revert to the previous setting.

3.4.3 Alarm acknowledge mode

This function programs the relays in the unit for latching or non-latching operation.

1. Press the **ENTER** key to adjust the setting.
Use the **UP/DOWN** cursor keys to toggle between settings:
 - **AUTO** non-latching (alarm relay will automatically de-energize when the gas level drops below its alarm point).
 - **MANUAL** latching (alarm relay remains energized, and will not release until the alarm condition has been manually acknowledged). (See 4.4.4 "Acknowledging Alarms").
2. Press **ENTER** to accept the new entry or **ESC** to revert to the previous setting.

3.4.4 Audible alarm

This parameter selects the function of the Multi-zone monitors internal audible alarm device.

1. Press the **ENTER** key to adjust the setting.
2. Use the **UP/DOWN** cursor keys to select unused, monitor on, evacuate, spill, leak, fault, or alarm.
3. Press **ENTER** to accept the new entry or **ESC** to revert to the previous setting.

	<p>NOTE: in "Monitor On" mode, the unit will only give audible alarms on a critical fault that stops the unit from monitoring</p>
---	--

3.4.5 Zone hold

Sets the length of time a zone will be monitored when the zone hold feature is activated. The default is 15 minutes and the range is 1 to 999 minutes.

1. Press the **ENTER** key to adjust this setting.
2. Use the **LEFT/RIGHT** cursor keys to move across the entry field and the **UP/DOWN** cursor keys to modify the individual numbers.
3. Press **ENTER** to accept the new entry or **ESC** to revert to the previous setting.

3.4.6 Detection limit

This is essentially a squelch setting that instructs the instrument to interpret PPM readings below the designated level as 0 and the range is 1 to 99 PPM.

1. Press the **ENTER** key to adjust the setting.
2. Use the **UP/DOWN** cursor keys to modify the setting.
3. Press **ENTER** to accept the new entry or **ESC** to revert to the previous setting.

3.4.7 Loop mode

This sets the loop mode of the two optional 4-20mA outputs, the options are:

- track zones mode (default)
- highest PPM concentration mode

	<p>NOTE: Both LOOP MODE (for selecting track zones or highest PPM mode) as well as the LOOP2 FACTOR (for scaling the PPM output) are configured from the SETUP menu. Configure one, then press ENTER to access the other</p>
---	--

In track zones mode the Multi-zone adjusts the ZONE and PPM outputs to correspond to the latest sampled zone number and its corresponding PPM concentration, respectively. For example, if the Multi-zone samples zone #9 at 63 PPM, the ZONE and PPM outputs would read 13mA (corresponds to zone #9) and 5mA (corresponds to 63 PPM), respectively, until the next zone is sampled.

This continues in a cyclic fashion through each zone. Note that this example assumes LOOP2 Factor was left at its default value (0.016).

This can be adjusted through the LOOP2 FACTOR option in the SYSTEM SETUP screen.

In highest concentration (PPM) mode the Multi-zone adjusts the two current outputs to correspond to the zone number that has the highest PPM concentration and the corresponding value of that concentration, respectively. Unlike track zones mode, this mode will adjust the two outputs to correspond to whichever zone has the highest PPM concentration. For example, if zone #9 is sampled at 125 PPM, the two 4 20mA outputs will read 13mA and 6mA, respectively, as long as it continues to sample at 125 PPM or until a different zone samples a concentration greater than 125 PPM.

3.4.8 Loop2 factor

This sets the PPM scale factor for current loop number 2. After setting the loop mode, the menu box changes to a lower-level menu that allows you to set the Loop2 Factor. To calculate the current output, multiply the scale factor by the PPM and add 4. For example, at the default scale factor of 0.016, a measurement of 100 ppm would generate a current output of 5.6mA DC, the current output cannot exceed the 20mA DC capacity of the interface.

1. Press the **ENTER** key to adjust the setting.
2. Use the **LEFT/RIGHT** cursor keys to move across the entry field and the **UP/DOWN** cursor keys to modify the individual characters.
3. Press **ENTER** to accept the new entry or **ESC** to revert to the previous setting.

	<p>NOTE: both LOOP MODE (for selecting track zones or highest PPM mode) as well as the LOOP2 FACTOR (for scaling the PPM output) are configured from the SETUP menu. Configure one, then press ENTER to access the other</p>
--	--

3.4.9 Re-zero mode

This parameter defines the frequency at which the instrument re-zeros the optical sensor.

1. Press the **ENTER** key to adjust the setting.
2. Use the **UP/DOWN** cursor keys to toggle between settings:
 - **AUTO** sets the instrument to re-zero every 10 minutes.
 - **ZONE CHANGE** sets the instrument to re-zero at each zone change. This is the most accurate setting, but increases the time interval between measurement cycles.
3. Press **ENTER** to accept the new entry or **ESC** to revert to the previous setting.

3.5 Navigating to the 3rd setup screen

3.5.1 Overview

From system setup screen #2, select the MORE option to go to system setup screen #3. Select the BACK option to return to system setup screen #2.

System setup screen #3

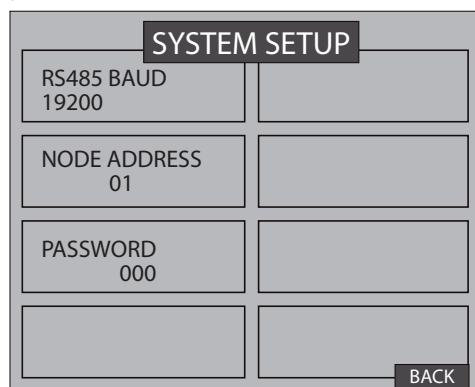

	<p>NOTE: the RS-485 BAUD rate text is replaced by "Service Timeout" when in Service Mode</p>
--	---

3.5.2 Baud rate

This parameter defines the baud rate for the RS-485 communications port.

1. Press the **ENTER** key to adjust the setting.
2. Use the cursor keys to scroll through a list of available baud rates to select the desired baud rate.
3. Press **ENTER** to accept the new entry or **ESC** to revert to the previous setting.

3.5.3 Node address

Each monitor on the network must have a distinct node address.
The node address may be set from 1 to 64.

1. Press the **ENTER** key to adjust the setting.
2. Use the **LEFT/RIGHT** cursor keys to move across the entry field and the **UP/DOWN** cursor keys to modify the individual numbers.
3. Press **ENTER** to accept the new entry or **ESC** to revert to the previous setting.

3.5.4 Password

This field is used to define a system password.
The default setting is 000, which provides no password protection.

1. Press the **ENTER** key to adjust the password.
2. Use the **LEFT/RIGHT** cursor keys to move across the entry field and the **UP/DOWN** cursor keys to modify the individual alphanumeric characters.
3. Press **ENTER** to accept the new password or **ESC** to revert to the previous setting.

	<p>NOTE: after entering the password (including the 1st time it is set), the Multi-zone begins a 30 minutes "inactivity" timer that is reset every time a key is pressed. When the timer reaches zero, password access is enabled. To enable password protection sooner, cycle power on the Multi-Zone. When password protected, a password entry is required in order to view screens other than the SYSTEM or ZONE VIEW screen</p>
---	---

3.6 Additional service features

The Service Mode option is located on the System Setup Screen in the bottom right corner. When activated, the Service Mode will disable the Multi-zone unit for a specified length of time. The default is 5 minutes, this time interval can be changed as described in the Service Timeout section below.

	<p>IMPORTANT: note that while in the Service Mode no measurements are made, nor are any alarms activated</p>
---	---

Access the service mode options from the initial Data Display Screen. Press the SERVICE MODE ENTRY option twice within 3 seconds, to exit the Service Mode, again press the SERVICE MODE ENTRY option twice within 3 seconds.

Several features can be viewed on the System Setup Screen #3 when the monitor is placed in service mode. While in service mode, the user can identify the model number, set digipot values and sensor temperature, and acquire the temperature coefficient.

System setup screen #3 (service mode)

SYSTEM SETUP	
SERV TIMEOUT 300 MINUTES	DET DIGIPOT 180
NODE ADDRESS 01	SENSOR TEMP C 0.00000
PASSWORD 000	ACQUIRE TEMPCO
MODEL 30155043	IR DIGIPOT 124 BACK

3.6.1 Service timeout

Displayed in Service Mode.

Sets the length of time the Service Mode is in effect, stops the monitor for up to 300 minutes (5hrs) to allow for servicing the unit.

1. Press the **ENTER** key to adjust the setting.
2. Use the **LEFT/RIGHT** cursor keys to move across the entry field and the **UP/DOWN** cursor keys to modify the individual numbers.
3. Press **ENTER** to accept the new entry or **ESC** to revert to the previous setting.

3.6.2 DET digipot

The DIGIPOT function allows manual and a more precise adjustment of the digital potentiometer, which controls the voltage of the IR Detector. The DIGIPOT is auto tuned at every power up.

1. Press the **ENTER** key to adjust the setting.
Once the option is selected the screen will also display the voltage.
2. Use the **UP/DOWN** cursor key to modify the digipot value.

3.6.3 Node address

Each monitor on the network must have a distinct node address.
The node address may be set from 1 to 64.

1. Press the **ENTER** key to adjust the setting.
2. Use the **LEFT/RIGHT** cursor keys to move across the entry field and the **UP/DOWN** cursor keys to modify the individual numbers.
3. Press **ENTER** to accept the new entry or **ESC** to revert to the previous setting.

3.6.4 Sensor temperature coefficient (for factory use only)

This field is typically for factory use only. A customer may need to enter a temperature coefficient if the IR bench is replaced and a new temperature coefficient is supplied with the replacement bench. Note, however, changing this setting will void the calibration.

3.6.5 Password

This field is used to define a system password. The default setting is 000 (no password protection).

1. Press the **ENTER** key to adjust the password
2. Use the **LEFT/RIGHT** cursor keys to move across the entry field and the **UP/DOWN** cursor keys to modify the individual alphanumeric characters
3. Press **ENTER** to accept the new password or **ESC** to revert to the previous setting

3.6.6 Acquiring temperature coefficient (for factory use only)

This field is for factory use only. Changing this setting will void the calibration.

3.6.7 IR digipot

This option indicates the electrical parameters of the infrared emitter.

3.7 Establishing the CO₂ sensor baseline

At power up, an automatic zeroing sequence establishes the CO₂ sensor baseline. At that time, the Multi-zone assumes the default ambient CO₂ level of 386 ppm, however, if:

- the purge line wasn't connected to the instrument, or
- the purge line was not terminated in fresh air

Then the sensor baseline may be compromised. If you suspect that the baseline was compromised, then you can re-establish the proper CO₂ sensor baseline by ensuring the purge line is properly installed and following the procedure below.

1. Restart the monitor by either (a) cycling the power, or (b) pressing the CPU reset switch on the main printed circuit board, (see figure below).

Location of CPU reset button

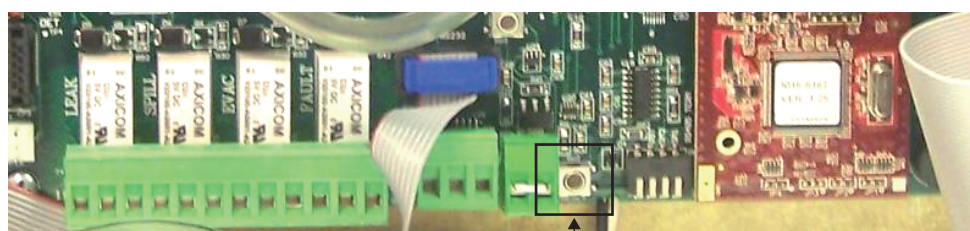

CPU Reset Switch



WARNING: if using the CPU reset switch to restart the instrument, extreme care should be exercised when accessing the interior of the monitor. This includes touching a non-painted area of the Multi-zone chassis to provide proper grounding prior to touching the CPU reset switch or any other internal components. Failure to touch a grounding area can allow static electricity on your clothing or body to damage the monitor. Such damage is not covered under warranty

2. After the restart and the warm-up have completed, the instrument is ready for use.

4.0 General operation

4.1 Functional overview

Normally each Multi-zone monitor will sequentially perform measurements on its active zones without user input. The total time it takes a Multi-zone monitor to complete a measurement cycle is directly proportional to the number of active zones and the physical length of the air lines. Monitors linked together on a network operate independently of each other and consequently complete their respective measurement cycles at different rates.

The Remote Display operates by polling the network approximately once every 12 seconds to determine the current status of the Multi-zone monitors. If more than one Multi-zone is connected to the network, it will sequentially poll each monitor for its status.

As a practical matter this simply means that the more complicated the network, the longer it will take the Remote display to update the status information for all zones.

4.2 The zone setup screen

From System Setup Screen #2, scroll **DOWN** to select the ZONES option.

Zone setup screen #1

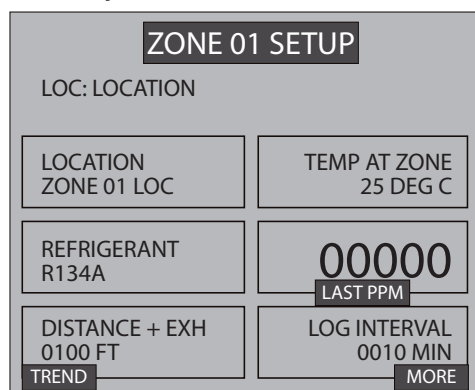

ZONE 01 SETUP	
LOC: LOCATION	
LOCATION ZONE 01 LOC	TEMP AT ZONE 25 DEG C
REFRIGERANT R134A	00000 LAST PPM
DISTANCE + EXH 0100 FT TREND	LOG INTERVAL 0010 MIN MORE

4.2.1 Location

This is the name you assign to the Multi-zone monitor to identify the zone location. It may have up to 12 alphanumeric characters.

1. Press the **ENTER** key to adjust the setting.
2. Use the **LEFT/RIGHT** cursor keys to move across the entry field and the **UP/DOWN** cursor keys to modify the individual characters.
3. Press **ENTER** to accept the new entry or **ESC** to revert to the previous setting.

4.2.2 Gas/refrigerant type

This parameter defines the kind of gas the Multi-zone is detecting.

1. Press the **ENTER** key to adjust the setting.
2. Use the **LEFT/RIGHT** cursor keys to select the type of gas you want the device to detect. (Options differ depending on model).
3. Press **ENTER** to accept the new entry or **ESC** to revert to the previous setting.

4.2.3 Distance + EXH

This parameter defines the combined length of the sample tubing plus any tubing on the exhaust port. Total length should not exceed 1200ft.

1. Press the **ENTER** key to adjust the setting.
2. Use the **LEFT/RIGHT** cursor keys to move across the entry field and the **UP/DOWN** cursor keys to modify the individual characters.
3. Press **ENTER** to accept the new entry or **ESC** to revert to the previous setting.

4.2.4 Temp @ zone

This parameter is used to set the expected temperature of the air at the zone being sampled. The value is used to calculate the STP PPM value shown in the diagnostic screen only.

1. Press the **ENTER** key to adjust the setting.
2. Use the **LEFT/RIGHT** cursor keys to move across the entry field and the **UP/DOWN** cursor keys to modify the individual characters.
3. Press **ENTER** to accept the new entry or **ESC** to revert to the previous setting.

4.2.5 Current detection reading

This reading displays the current PPM level of the selected gas.

4.2.6 Log interval

The Multi-zone retains a data log of 100 measurements for each zone, the log interval is the number of minutes from 1 to 1440 between each log point. This parameter can be changed from Zone Setup Screen #1.

The default setting for this parameter is 10 minutes. If the log interval time is set to 0, then a measurement is recorded in the trend log after every measurement cycle. Therefore, after the trend log is filled, it will contain the last 100 measurement points for a zone. If you want the data logged less frequently, increase this value. It is important to remember that cycle time is dependent on many factors, including the number of zones monitored, input line length, and the run zeroing mode selected.

Before changing this value it may be useful to first review the log data using the Trend Screen to determine the nominal cycle time.

4.3 Navigating to the 2nd zone setup screen

Select the MORE option at the bottom right side of the first Zone Setup screen to continue to the next screen containing more options. This screen displays the peak PPM value in the upper left side of the screen.

Navigating from the first to the second zone screen

ZONE 01 SETUP	
LOC: LOCATION	
LOCATION ZONE 01 LOC	TEMP AT ZONE 25 DEG C
REFRIGERANT R134A	00000 LAST PPM
DISTANCE + EXH 0100 FT	LOG INTERVAL 0010 MIN
TREND	MORE

ZONE 01 SETUP	
PEAK PPM STP	00009 5/27/2011 10:57:59
LEAK LEVEL 00100 PPM	PRESS TO RESET PEAK
SPILL LEVEL 0300 PPM	
EVAC LEVEL 00500 PPM	
TREND	BACK

4.3.1 Leak level

This is the concentration level in PPM that will activate a leak alarm condition.

1. Press the **ENTER** key to adjust the value.
2. Use the **UP/DOWN** cursor keys to modify the setting.
3. Press **ENTER** to accept the new entry or **ESC** to revert to the previous setting.

	<p>NOTE: the leak level value must be less than the spill level</p>
---	--

4.3.2 Spill level

This is the concentration level in PPM that will activate a spill alarm condition.

1. Press the **ENTER** key to adjust the value.
2. Use the **UP/DOWN** cursor keys to modify the setting.
3. Press **ENTER** to accept the new entry or **ESC** to revert to the previous setting.

	<p>NOTE: the spill level value must be less than the evacuation level and greater than the leak level</p>
---	--

4.3.3 Evacuation level

This is the concentration level in PPM that will activate an evacuate alarm condition.

1. Press the **ENTER** key to adjust the value.
2. Use the **UP/DOWN** cursor keys to modify the setting.
3. Press **ENTER** to accept the new entry or **ESC** to revert to the previous setting.

	<p>NOTE: the evacuation level value must be greater than the spill level</p>
---	---

4.3.4 Re-setting the peak PPM value

Pressing this key resets the current peak PPM level stored in memory and displays it at the top of the screen.

4.4 Alarms

4.4.1 Functional overview

If the PPM level for any zone exceeds its designated spill, leak, or evacuate thresholds, an alarm condition will be created. Once the Multi-zone monitor completes a measurement cycle in the affected zone the alarm condition will be indicated. At that time the red ALARM LED on the Multi-zone monitor will glow. Additionally, an external alarm device may activate and an audible alarm may sound if those features have been enabled.

The next time the Remote display polls the affected monitor its red ALARM LED will glow. Additionally, an external alarm device may activate and an audible alarm may sound if those features have been enabled.

4.4.2 Responding to alarms

An operator can respond to the alarms by accessing the Alarm Summary Screen. Navigate to this screen by selecting ALARM on the first (Data Display) screen.

Alarm summary screen

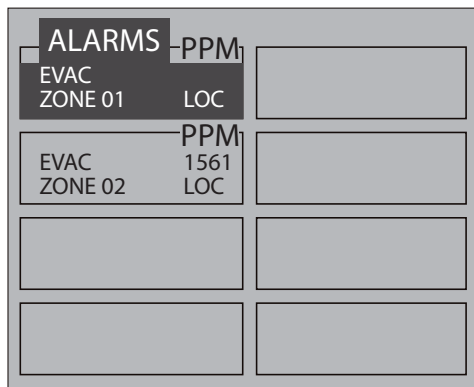

The Alarm summary screen displays a list of all alarm conditions pending across the network. The screen is divided into 8 boxes, and each box represents a single alarm. If more than 8 alarms are pending, the MORE option will be displayed at the bottom of the screen to permit access to that additional information.

Each box displays the zone number, zone name, and the current PPM reading. A flashing box indicates an alarm that has not been acknowledged. A static box represents an alarm that has been acknowledged, but has not yet been cleared from the system.

4.4.3 Alarm detail screen

To further investigate an alarm, press the **ENTER** key to go to the Alarm detail screen.

Alarm detail screen

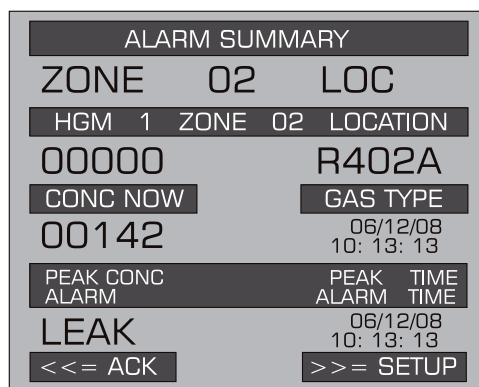

The Alarm Detail Screen displays more comprehensive information about the nature of the alarm including:

- complete location information
- gas type and current concentration (CONC NOW)
- peak concentration and peak time
- alarm type, alarm time, and date

This screen provides the following navigation options at the bottom of the display:

- **ACK:** using the **LEFT** key, acknowledges the alarm as described in the next section.
- **SETUP:** using the **RIGHT** key, navigate to the Zone Setup Screen #1. This enables review of the zone setup parameters and access to the Trend Screen.

Use the **ESC** button on the front case to go back to the previous menu.

4.4.4 Acknowledging alarms

Each pending alarm may require, depending upon selected alarm mode, acknowledgment before the system returns to normal operation, (see 3.4.3. "Alarm acknowledge mode"). To acknowledge an alarm, navigate to the Alarm Detail Screen and select the ACK option as previously described. You will then be returned to the Alarm Summary Screen and the box associated with that alarm will no longer be blinking, indicating that the alarm has been acknowledged.

Repeat this procedure to acknowledge any remaining alarms.

Alarm summary screen (acknowledge mode)

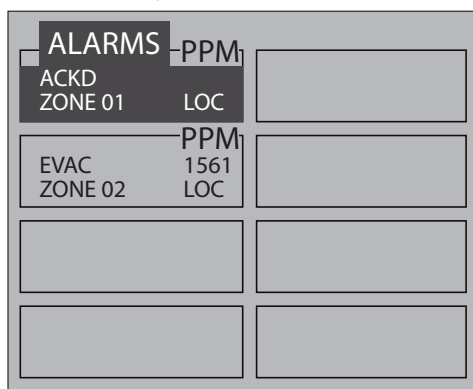

Once all the alarms associated with a given Multi-zone monitor are acknowledged, its RED LED will turn off and any external alarms connected to the Multi-zone relays will de-activate. All pending alarms across the entire network must be acknowledged before the Remote Display returns to normal operation. Once that occurs, its RED LED will turn off and any associated external alarms connected to the Remote display relays will de-activate.

Keep in mind that the system will continue to generate new alarms if PPM values above the alarm thresholds are detected.

4.4.5 Silencing an alarm

When alarms are active, the **ESC** key functions as a silence key. During an active alarm and with the main screen displayed, press the **ESC** key, this will generate a prompt to "PRESS ENTER TO CONFIRM SILENCE". When **ENTER** is pressed, the LEAK relay will open and the internal audible alarm (if enabled) will turn OFF, in this way, when the LEAK relay is used to operate strobes and horns, they can be quickly silenced without effecting the SPILL or EVAC, which may be controlling fans or ventilation equipment. This "silence" mode will be indicated by a reverse flashing "S" in the alarm window. "Silence mode" will be automatically canceled if the alarm condition of any zone changes by clearing or elevating to a higher level.

4.4.6 Clearing the alarm event log

A data log of the last 20 alarm events is retained in memory.

- From the data display screen, press the **UP** or **DOWN** key. **SETUP** will be highlighted in the first box.
- Press the **DOWN** key until alarm event log is highlighted, then press **ENTER** to select this option and display the alarm event log, (see below).

Accessing the alarm event log

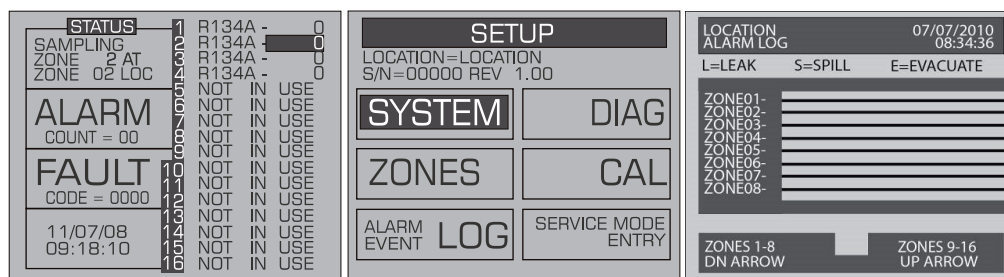

This screen lists zones in the left column and displays which alarms were associated with each zone as represented by the vertical cursor bar. As you move the bar horizontally using the **LEFT/RIGHT** keys, the date and time the alarm condition was detected is displayed in the upper right hand corner of the display window.

NOTE: the alarm event log can be reset by pressing a combination of the **ENTER** and **RIGHT** buttons while viewing the log

4.5 System faults

4.5.1 Functional overview

If a system malfunction occurs, the yellow **FAULT** LED will glow, additionally, an external alarm device may activate and an audible alarm may sound if those features have been enabled, (see 2.10 "Connecting external alarms" and 3.4.4 "Audible alarm").

The next time the Remote display polls the affected monitor its yellow **FAULT** LED will also glow. Additionally, an external alarm device may activate and an audible alarm may sound if those features have been enabled (see 2.10 "Connecting external alarms" and 3.4.4 "Audible alarm").

Depending on the nature of the fault, the Multi-zone monitor may or may not continue to operate normally. Under a non-critical fault condition, the Multi-zone will continue to measure and log data, but some peripheral functions may be compromised, under a critical fault condition, action is required for the Multi-zone monitor to operate normally. The table on the following page lists the various fault conditions and explains what action should be taken to correct the problem.

NOTE: the fault codes are cumulative. For example, a code <4200> is both a <4000> "REZERO VOLT TOL" and <0200> "GAIN SET FAULT" combined, indicating two simultaneous faults

4.5.2 Navigating to the fault screen

Displayed on the initial data display screen is a fault option, scroll down with the cursor key and select this option, which will introduce you to the fault screen.

Fault screen

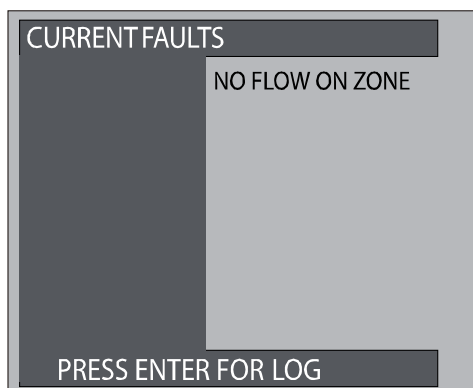

4.5.3 Critical faults

Fault	Code	Description/possible causes
NO FLOW ON ZONE	<0800>	<p>Go to the data display screen and press the FAULT key. This will display a "NO FLOW" message in each individual zone affected. Check for a blockage in the air sample line or at the line end filter, once the blockage has been cleared, the Multi-zone monitor will return to normal operation after the zone has been sampled</p> <div style="border: 1px solid black; padding: 5px; display: flex; align-items: center;"> <p>NOTE: this can take some several minutes since it is dependent upon how many zones there are and their lengths. The Multi-zone will clear the fault the next time it polls the effected zone and the Remote display will return to normal operation the next time that it polls the Multi-zone</p> </div>
NO FLOW ON PURGE	<1000>	Check the purge line for a blockage. Verify that the length of the purge line and exhaust line do not exceed 500ft in length
CLIPPING FAULT	<8000>	The detector voltage may be out of tolerance. For information on troubleshooting this type of fault, (see 5.3 "Troubleshooting")
REZERO VOLT TOL	<4000>	The detector output voltage is out of tolerance. For information on troubleshooting this type of fault, (see 5.3 "Troubleshooting")
OVER RANGE DETECTED	<2000>	This indicates that the measured concentration on one or more zones have exceeded the measurement range. For information on troubleshooting this type of fault, (see 5.3 "Troubleshooting")
ZERO FILTER FAULT	<0100>	Indicates contamination in the purge air, or if a charcoal filter is in use, the filter may need to be changed

Fault	Code	Description/possible causes
GAIN SET FAULT	<0200>	Indicates sensor gain (digipot) is outside acceptable range. For information on troubleshooting this type of fault, (see 5.3 "Troubleshooting")
A2D FAULT	<0400>	Analog to digital converter not working
BOX TEMP FAULT	<0001>	Enclosure's internal temperature is outside normal range (or IR sensor has failed). Check the installation to verify that the monitor is not being subjected to extreme temperatures. Verify that the ventilation holes are not obstructed. Refer to the diagnostic screen for the ZERO temperature, BNCH temperature and BOX temperature. Call the factory with this information for further instructions
BENCH TEMP FAULT	<0002>	Optical bench is outside of normal operating range (or sensor has failed). Check the installation to verify that the monitor is not being subjected to extreme temperatures. Check the diagnostic screen for the ZERO temperature, BNCH temperature and BOX temperature. Call the factory with this information for further instructions
PRESSURE SENSOR	<0004>	Manifold pressure is outside normal operating range (or sensor has failed). Check the diagnostic screen record ALL data. Call the factory with this information for further instructions
RS-485 FAULT	<0008>	RS-485 communications error
LOOP FAULT	<0010>	This would only be displayed if the dual 4-20mA DC option was installed and one or both current loops are open. Check the wiring to load/monitoring circuit on both 4-20mA loops
CONFIG FAULT	<0080>	There is an error in Setup Screen #2 - Number Zones Installed field, or in RDM Setup Screen #1 - Number of Multi-zone monitors on Network field. Check that the number of zones installed for each Multi-zone unit and the actual number of Multi-zone units on the network are properly programmed. Check to ensure that the manifold solenoid cable connector in each Multi-zone unit is securely fastened to its terminal connector. If necessary, reset to the factory default settings

4.5.4 Reset to factory default settings

	<p>NOTE: performing this function wipes out all program parameters, alarms, faults, trends and log files</p>
--	---

1. Press and hold down the **UP** and **DOWN** keys on the Multi-zone monitor.
2. Cycle AC power OFF then ON.
3. Hold the keys until the second beep is heard.
4. The screen will indicate "This unit has been reset to factory default conditions".
5. Release the keys.
6. Reprogram the Multi-zone as described in this manual.

4.5.5 Clearing system faults

If the fault condition is associated with an Multi-zone, the monitor will return to normal operation soon after the problem is corrected. At that time the YELLOW LED will turn off and any external alarms connected to the monitor's alarm relays will also turn OFF. The Remote display will return to normal operation the next time it polls the affected Multi-zone monitor.

Once the system malfunction has been corrected it may take some time for the fault condition to clear completely. If the fault is associated with a specific zone, the Multi-zone must first cycle back to the affected zone before it returns to normal operation. At that time the YELLOW LED will turn OFF and any external alarms connected to the monitor's alarm relays will also turn OFF. The Remote display will return to normal operation the next time it polls the affected monitor.

4.5.6 Viewing fault log

A data log of the last 20 fault conditions is retained in memory. On the fault screen, select the LOG option to view a display of the fault log.

Fault log screen

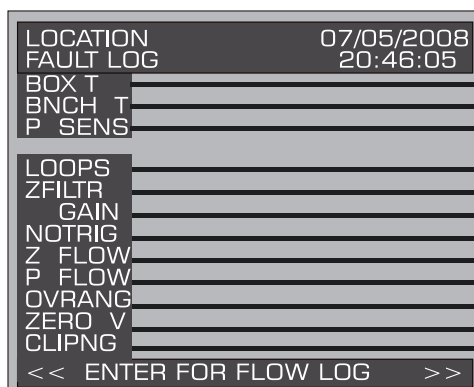

This screen lists potential fault conditions in the left column and displays a check mark indicating which problems were associated with each fault condition as represented by the vertical cursor bar. As you move the bar horizontally using the **LEFT/RIGHT** keys, the date and time the fault condition was detected is displayed in the upper right hand corner of the display window.

	NOTE: anytime the fault status changes, there is an entry in the fault log, both when the fault occurs and when it is cleared
	NOTE: the fault log can be reset by pressing a combination of the ENTER and RIGHT buttons while viewing the log

4.5.7 Viewing flow log

On the fault log screen, press **ENTER** to access the flow log screen. The flow log displays the last 20 flow events for all zones and the purge port.

Flow log screen

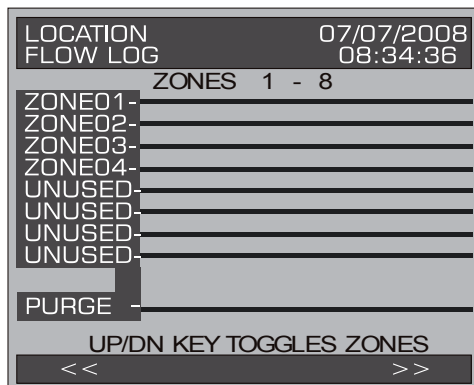

This screen lists the zones in the left column and displays flow data. Use the **UP/DOWN** buttons to scroll through the zones and the **LEFT/RIGHT** to scroll through the log data. As you move the bar horizontally, the date and time of the condition is displayed in the upper right hand corner.

The flow log can be reset by pressing a combination of the **ENTER** and **RIGHT** buttons while viewing the log.

4.6 The trend screen

4.6.1 Navigating to the trend screen

From the zone screen, select the trend option on the bottom left side, this will open the trend screen.

The trend graph opens with the cursor located over the most recent data point. Use the **LEFT/RIGHT** keys to move the cursor to different data points. Holding a key down will cause the cursor to move rapidly across the screen. As you move the cursor position, the date and time of that reading, along with the PPM value, are displayed at the top of the screen above the graph.

The trend graph is automatically scaled to accommodate the largest PPM value displayed. The ZOOM OUT and ZOOM IN options allow you to adjust the vertical scale of the graph.

The trend data is stored on a first-in, first-out basis. After 100 trend values have been stored the 101st value will replace the first value stored. Therefore, in normal operation, when entering trend mode the cursor will be located at the most recent data point. The data points to the left of the initial cursor location will be the next most recent. The data point to the right will be the oldest data point in the buffer and will be over written by the next data point.

Trend screen

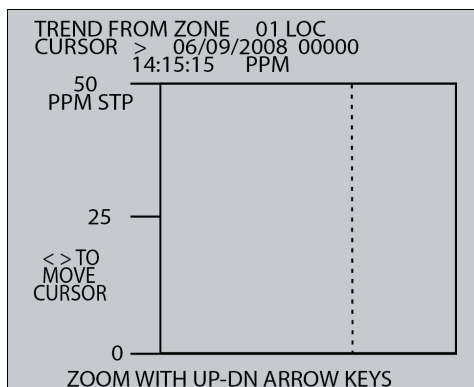

	<p>NOTE: the trend data log can be reset by pressing a combination of the ENTER and RIGHT buttons while viewing the log</p>
--	--

When finished, press the **ESC** key to revert to the previous screen.

4.7 The calibration screen

4.7.1 Overview

The calibration screen is used to adjust the calibration factor for each gas, it is also used to program the instrument (halogen only) for new gases.

	<p>IMPORTANT: changing information on CAL FACTOR will void the factory calibration. Typically, the unit will remain within the factory-calibrated accuracy indefinitely and no calibration is required. Complex software algorithms adjust for temperature drift, IR source aging, and pressure changes in order to keep the unit within factory accuracy specifications</p>
--	---

4.7.2 Navigating to the calibration screen

On the system setup screen, select the calibration option (CAL).

Calibration screen (HGM and AGM only)

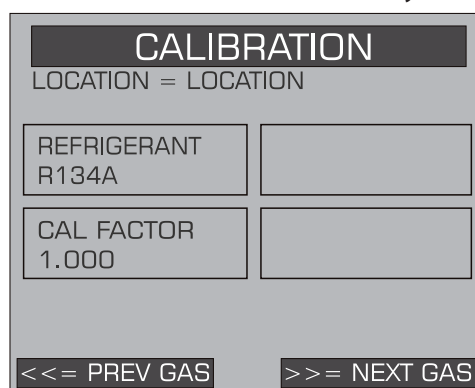

4.7.3 Calibration procedure (HGM and AGM only)

The CAL FACTOR is determined by sampling a known dilution of the type of gas to be sampled. Calibration is best performed at or near full scale, it can, however, be done at any concentration, and ideally in the range where maximum accuracy is desired down to, but not below, 100 PPM.

A cylinder of the desired gas at a certified PPM level must be used to assure sampling occurs at ambient conditions, a minimum sample size of 5lt is required.

The Multi-zone monitor should be operating for at least one hour prior to performing a calibration. Prepare the Multi-zone for sampling by initially setting its CAL FACTOR to 1.000. Next, set up the Multi-zone for a logging interval of zero minutes, and place the Multi-zone monitor in its zone hold mode for the zone you wish to use for calibration purposes.

Connect the sample bag directly to the intake port for the zone you have set up and allow the Multi-zone monitor to sample the entire bag, when sampling is complete, view the trend data for the zone used to sample. Read the measured PPM by placing the cursor on the spikes cause by the sample. If the bag was large enough for multiple samples, average the most stable ones.

The new CAL factor is computed by dividing the known gas value by the measured value, typically this value will be between 0.95 and 1.05. This value is stored in non-volatile memory.

4.7.4 Adjusting calibration factor (HGM and AGM only)

The factory default cal factor for standard units is 1.000. This value may be different if the high accuracy option is ordered.

Proceed as follows to adjust the current calibration factor:

- Use the PREV GAS or NEXT GAS options to scroll through the list of gases until the gas you wish to work with is displayed.
- Select the CAL FACTOR option to edit the value.
- Use the **LEFT/RIGHT** keys to move across the entry field and the **UP/DOWN** keys to modify the individual numbers.
- Press **ENTER** to accept the new entry or **ESC** to revert to the previous setting.



NOTE: the CO₂ calibration is a more complex, 2-point calibration. CO₂ units are factory calibrated and not intended to be calibrated in the field.
(See 5.7.5 "CO₂ Atmospheric Concentration")

4.7.5 CO₂ atmospheric concentration

Because CO₂ is present in ambient air, a relative reading is used to determine the amount of CO₂ coming from a leak. The CAL screen offers the ability to manually enter the ambient CO₂ concentration. This value is typically in the range of 380-400 ppm, however concentrations may vary slightly based on geographic locations or other factors (the factory default setting is 386 ppm).



IMPORTANT: the ambient CO₂ level is set at the factory to 386 ppm and will likely not need to be changed. If, however, the ambient CO₂ concentration at your location is known to be a value other than this default value, then the instrument's ambient CO₂ setting may need to be changed

If needed, adjust the ambient CO₂ concentration as follows:

- From the SYSTEM SETUP menu, navigate to the CAL screen.
- Ensure the GAS TYPE setting is selected and press **ENTER**.
- CO₂ calibration curve options are displayed. Simply press **ENTER** to access the ambient CO₂ concentration setting (PPM IN PURGE).
- Use the **UP/DOWN** keys to modify the numbers to set to the appropriate value.
- Press **ENTER** to accept the new entry or **ESC** to revert to the previous setting.

Accessing the CO₂ atmospheric concentration setting (PPM IN PURGE)

2 PT CALIBRATION		2 PT CALIBRATION	
GAS TYPE CO ₂	STORE CURRENT	PPM IN PURGE 00386.0	STORE CURRENT
CAL CONC PPM 01995.0	23.5 DEG C NO GAS	CAL CONC PPM 01995.0	23.5 DEG C X
LOW TEMP 25.9 DEG C	LOW FACTOR 0.970	LOW TEMP 25.9 DEG C	LOW FACTOR 0.970
HI TEMP 43.7 DEG C	HI FACTOR 0.842	HI TEMP 43.7 DEG C	HI FACTOR 0.842

	<p>IMPORTANT: do not alter any other parameters within the calibration menu as this will alter the factory calibration</p>
--	---

4.7.6 Programming new gases (HGM only)

As new gases come into use the Multi-zone monitor allows the addition of these new gases to its on-board gas library. At the end of the gas library list is an option labeled CUSTOM for adding new gases. From the calibration screen use the **LEFT/RIGHT** to select CUSTOM from the list of gases. Next, press **ENTER**, and use the **UP/DOWN** keys to enter the calibration factor. The selection of the matching gas and CAL factor is performed by Danfoss by analyzing the new gas. Once the matching gas is determined, field calibration is possible by using the same procedure as for other gases. When the new gas entry is complete simply setup the appropriate zone for CUSTOM.

Program the instrument for a new gas as follows:

1. From the calibration screen, use the PREV GAS or NEXT GAS options to scroll through the list of available choices until the CUSTOM option is displayed.

Custom gas screen (HGM only)

CALIBRATION	
LOCATION = LOCATION	
REFRIGERANT CUSTOM	
CAL FACTOR 1.000	
<<= PREV GAS	>>= NEXT GAS

2. Select the CUSTOM option. Press **ENTER** to accept the new entry or **ESC** to revert to the previous setting.
3. Enter the new CAL Factor as received from Danfoss.

4.8 Zone hold mode

A zone can be placed on hold and continuously monitored for a length of time determined by the zone hold time value. To place a zone on hold, select the zone at the main run screen, then press and hold down the **ENTER** key until the unit beeps. The word "HOLDING" will appear in the status box.

While in the hold mode, further investigation of the zone's status can be made by navigating to that zone's setup screen #1. To release the zone from the hold mode, press and hold down the **ENTER** key until the unit beeps and the screen display returns to normal.

4.9 The diagnostic screen

4.9.1 Navigating to the diagnostic screen

On the system setup screen, select the diagnostic option (DIAG).

Diagnostic screen

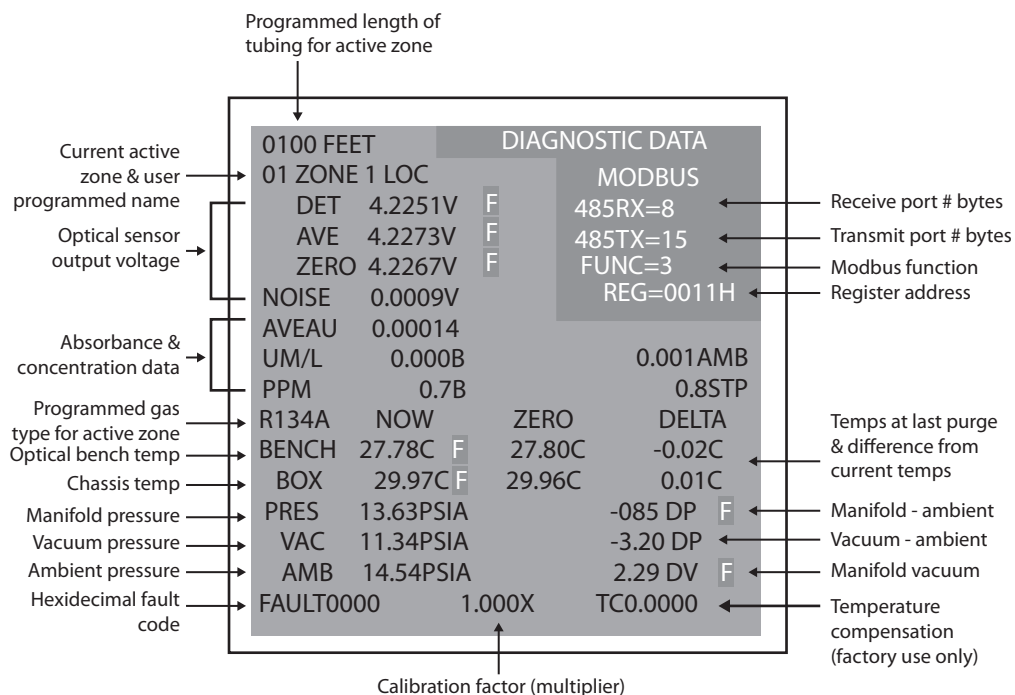

F Indicates parameter is out of tolerance & causing a fault condition

Diagnostic options & controls

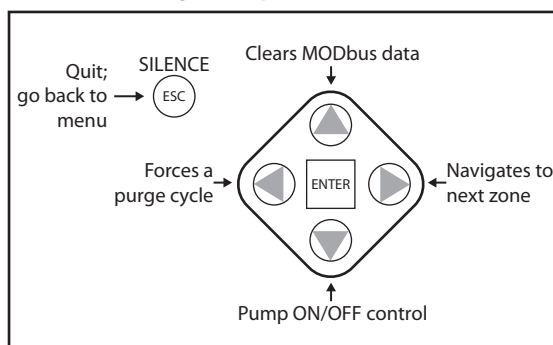

4.9.2 Diagnostic screen overview

The diagnostic screen contains sensor data and status information useful for trouble shooting various fault conditions. An explanation of the information provided on each line of this screen is listed below, including normal operating ranges.

Field Name	Description								
xxxx FEET	Programmed length of tubing for an active zone								
xx ZONE name	Current active zone and user-programmed name. This field may also show "WARM UP" during warm up mode								
DET	Detector Voltage - Peak-to-peak output of the IR sensor. In the absence of gas, this value range is 4.100V to 4.300V								
AVE	Average Detector Voltage - Running average of the values displayed in line 1								
ZERO	Zero Voltage - IR sensor output that was stored during the last purge cycle and has the same range as line 1								
NOISE	A 16 point running average of the noise portion of IR bench output. This reading is valuable mostly when gas is not present								
AVEAU	Average Absorbency - Optical absorbency computed from the Average Detector Voltage and Zero Voltage. In the absence of selected gas, the absorbency is 0.000AU. When sampling desired gas, its value varies proportionally with the gas concentration								
UM/L	uMoles/L - Absolute concentration in micro-moles per liter of gas based on Noise and the internal calibration. There are two figures displayed. The first (annotated by a B) is the actual measurement at the IR bench. The second is the calculated value corrected to ambient conditions (temperature + pressure)								
PPM	Parts Per Million is the volume concentration referenced to standard temperature and pressure and is computed from the Average Absorbency, Zero Temperature and Ambient Pressure. There are two figures displayed. The first (annotated by a B) is the actual PPM at the IR bench. The second is a PPM reading normalized to standard temperature and pressure								
ZERO	Zero Temperature - Displays the sensor and enclosure temperature measured and stored during the last purge cycle in °C								
BENCH	Bench Temperature - Current IR sensor temperature in degrees C as well as the raw voltage coming from the temperature sensor. This value can range from ambient to ambient +15°C								
BOX	Box Temperature - This is the current internal enclosure temperature along with the raw voltage from the temperature sensor, and has the same range as the Bench temperature								
PRES	Pressure - This is the current absolute manifold pressure in PSIA along with the output voltage of the pressure sensor. This value should always be 0.2 to 1.0 PSIA below ambient (AMB)								
VAC	Vacuum - The vacuum pressure is measured every purge cycle by closing all sample valves. Its value is typically 2.5 to 4.0 PSIA below ambient pressure								
AMB	Ambient - Ambient pressure is measured every purge cycle with the sample pump off and the manifold open. Its value is weather and altitude dependent and can range from 10.0 to 15.5 PSIA								
FAULT	Fault code listed in hexadecimal. (See Fault Code list)								
y.yyyX	Calibration multiplier used when measuring concentration								
TCx.xxxx	Temperature Compensation - magnitude of voltage applied to sensor output (in volts). Factory use only								
MODBUS data	<table border="0"> <tr> <td>485 RX=x</td> <td>Receive port number of bytes</td> <td>FUNC</td> <td>Function</td> </tr> <tr> <td>485 TX=x</td> <td>Transmit port number of bytes</td> <td>REG=xxxxx</td> <td>Register address</td> </tr> </table>	485 RX=x	Receive port number of bytes	FUNC	Function	485 TX=x	Transmit port number of bytes	REG=xxxxx	Register address
485 RX=x	Receive port number of bytes	FUNC	Function						
485 TX=x	Transmit port number of bytes	REG=xxxxx	Register address						

5.0 Maintenance

	WARNING: shock hazard! Always disconnect AC power before opening the enclosure of the monitor
	WARNING: the AC power ground wire must first be connected to the monitor's ground stud. Under no circumstances should this monitor be operated without a protective ground. Doing so poses a potential shock hazard, and is a violation of electrical safety standards applicable to this type of equipment
	WARNING: electrical installation should be performed by a certified electrician, and must comply with all applicable NEC/CEC and local electrical safety codes
	IMPORTANT: the Multi-zone monitor contains sensitive electronic components that can be easily damaged. Do not touch nor disturb any components. Do not dislodge electrical wiring or pneumatic tubing

5.1 Troubleshooting

Certain critical faults may be corrected by checking and adjusting the detector voltage and/or emitter power. These faults include:

- CLIPPING FAULT <8000>.
- REZERO VOLT TOL <4000>.
- OVER RANGE DETECTED <2000>.
- GAIN SET FAULT <0200>.

To troubleshoot any of the above faults, use the procedure listed below.

1. With the monitor in either Warm Up Mode (flashing green LED) or Sampling Mode (solid green LED), access the Setup Menu by pressing the **ENTER** key twice.
2. Scroll to the bottom right of the screen to select the "Service Mode Entry" option.
3. With the "Service Mode Entry" option highlighted, press **ENTER** twice to enter Service Mode.
4. Scroll to the "SYSTEM" option and press **ENTER**.
5. Scroll to the "MORE" option and press **ENTER**. Note that "MORE" will flash when it is selected.
6. Scroll to and select the "IR DIGIPOT" option, (see below) and press **ENTER**.
7. Use the **UP** and **DOWN** arrows to adjust the MW reading to 450 (or as close as possible). When at the proper value, press **ESC** once.

Sample DIGIPOT readings

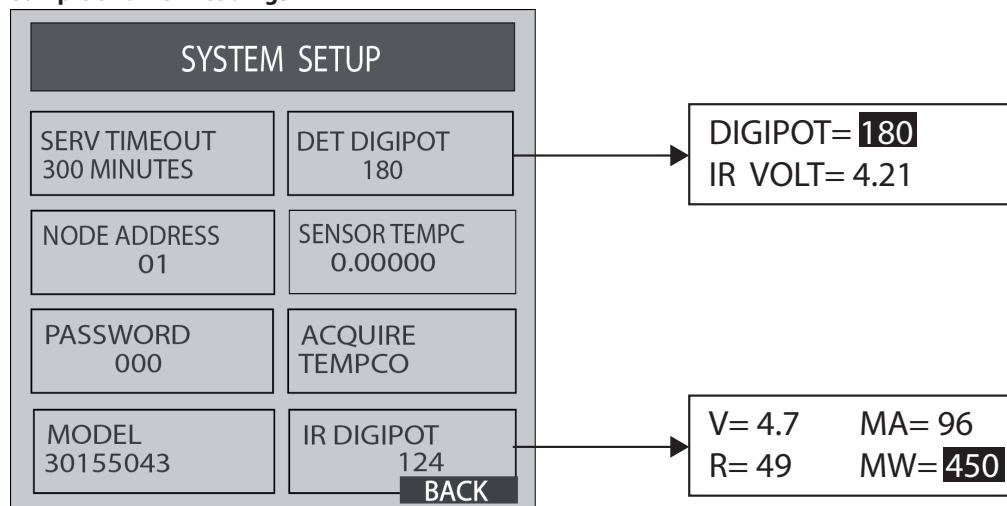

8. Scroll to "DET DIGIPOT" option, (see above) and press **ENTER**.

- Use the **UP** and **DOWN** arrows to adjust the IR VOLT reading to 4.20 (or as close as possible). When at the proper value, press **ESC** once.



IMPORTANT: if IR VOLT does not reach 4.200 ± 0.100 volts when adjusting the DIGIPOT, return to step 6 to lower the IR emitter setting. If the IR emitter setting is 450 ± 20 mW, adjust the new IR emitter setting to 375 ± 20 mW. Repeat step 8 with the new IR emitter setting

- Press **ESC** to save.
- Press **ESC** to get to the System Menu. Scroll to Service Mode and press **ENTER** twice to leave Service Mode.
Press **ESC** once and allow the instrument to complete a pressure check and purge cycle (approximately 2 minutes).

If the faults cannot be cleared using the above procedure, call the factory for further assistance.

6.0 APPENDIX A

Recommended refrigerant gas alarm settings

Gas	Alarm Settings (PPM)		
	Leak	Spill	Evacuate
CO ₂ /R-744	1500	2000	3000
FA188	100	300	500
FC72	100	300	500
H1301	100	300	500
H1211	100	300	500
H2402	100	300	500
H1234YF	100	300	500
HFP	100	300	500
N1230	100	300	500
NH ₃ /R-717	50	150	300
R11	100	300	500
R12	100	300	500
R21	100	300	500
R22	100	300	500
R23	100	300	500
R32	100	300	500
R113	100	300	500
R114	100	300	500
R123	25	35	50
R124	100	300	500
R125	100	300	500
R134A	100	300	500
R227	100	300	500
R236FA	100	300	500

Gas	Alarm Settings (PPM)		
	Leak	Spill	Evacuate
R245FA	100	300	500
R401A	100	300	500
R402A	100	300	500
R402B	100	300	500
R404A	100	300	500
R407A	100	300	500
R408A	100	300	500
R407C	100	300	500
R409A	100	300	500
R410A	100	300	500
R422A	100	300	500
R422D	100	300	500
R424A	100	300	500
R426A	100	300	500
R427A	100	300	500
R438A	100	300	500
R500	100	300	500
R502	100	300	500
R503	100	300	500
R507	100	300	500
R508B	100	300	500
R-717/NH ₃	50	150	300
R-744/CO ₂	1500	2000	3000

7.0 APPENDIX B

RS-485 communications protocol

7.1 Overview

The following instructions are intended as a guide for integrating the Multi-zone network into a Building Management System. If you are unfamiliar with complex systems of this type, it is recommended that you contact Danfoss for technical assistance.

7.2 MODbus RTU Protocol

The Multi-zone monitor communicates with master devices (such as the Remote display or a building management system) over the RS-485 serial interface. Because the monitor is configured with a two wire RS-485 serial bus, data transmission occurs in "half-duplex" mode. Therefore, only one device may be in transmit mode at any given time.

This document specifies the MODbus communications protocol as implemented on the applicable instruments. Programmers should refer to the MODbus protocol reference guide for details and more comprehensive instructions.

7.3 Multi-zone MODbus RTU operation

7.3.1 Overview

The Multi-zone and Remote display are equipped to communicate with other equipment using the MODbus RTU protocol. Using this communications channel a MODbus master device may communicate with up to 15 Multi-zone monitors on a communications network, exchanging measurement information, alarm data, fault data, history (logs and trends) and setup information. Additionally, the MODbus master can control the operating state of an Multi-zone monitor, placing the Multi-zone in any of its different operating modes. The network may be configured so that the Multi-zone monitors are connected directly to the MODbus master device, or the MODbus master device may communicate with the Multi-zone through the RD.



NOTE: this document was written with the assumption that the reader is familiar with the various setup parameters and operational modes for the Multi-zone

7.3.2 Protocol details

A 2 wire RS-485 bus is used for transmission, therefore communications occurs in a Half-Duplex mode. The Multi-zone is a slave device and will respond to queries in the MODbus RTU format from a master device.

Two MODbus functions are supported. They are function 03 (read holding register) and function 16 (Preset Multiple registers).

Using the two MODbus functions, a master device may read, modify and write data and status information to any monitor on the network. Data is organized into structures (internal to the Multi-zone monitor) which can be accessed by the MODbus registers defined in this document. A corresponding set of data structures should be maintained by the master device. These master device data structures become the destination for responses to read queries and sources for preset register commands. When a read holding register query is made by the master device the Multi-zone monitor responds by sending the contents of the structure referenced by the specified register. After the master validates the Multi-zone response using the CRC bytes, it must then move the data into its matching data structure before individual items may be accessed or modified.

Therefore, the master data structure should correspond to the Multi-zone data structure byte for byte.

	<p>NOTE: some data structures have been divided into multiple registers due to MODbus RTU message length constrains</p>
--	--

To change a setting in the Multi-zone monitor, the master device first reads the register structure that contains the data item to be modified, makes the desired change, then sends the structure back using the preset multiple register function. If the transaction is successful, the Multi-zone monitor sends the appropriate MODbus response. It is the responsibility of the master device, when making modifications, to insure that all parameters transferred are within the working limits of the Multi-zone.

	<p>IMPORTANT: each time parameters are modified and sent back to the monitor using function 16 (preset multiple registers), the new values are written to the monitor's non-volatile FLASH memory. Due to the finite write life of the FLASH memory device (10 K-100 K write cycles), modifying and writing variables should be performed on an "as needed" basis and not periodically. Exceeding the FLASH write life can result in memory corruption, requiring a CPU board replacement</p>
--	--

7.3.3 Multi-zone monitor polling

After the Multi-zone monitors are setup and operating, the master device need only poll each monitor for its status register which contains summary data of the monitors' alarms, faults, and operating state.

If exceptions are detected through the status register and more details are required, additional registers can be examined. Also if current PPM values are required, the PPM register provides access to current PPM values for all zones.

The Multi-zone monitor requires a minimum of 20 seconds to complete a gas concentration measurement for a single zone. Therefore, it is not necessary to poll the Multi-zone monitor more frequently than once every 15-20 seconds, as there will not be any new data available/obtained by more frequent polling. In fact, excessive polling will slow the operation of the Multi-zone.

Under no circumstances should the Multi-zone monitor be continuously polled at rate faster than 500 ms, as this could result in erroneous readings by the Multi-zone monitor.

7.3.4 Network topologies

Multi-zone monitors may be connected directly to the MODbus network or they may be connected to the network through a Remote Display.

In either case, each Multi-zone monitor must have a unique node ID.

Up to 15 Multi-zone monitors can be connected directly to the MODbus network.

If Multi-zone monitors are accessed via an Remote display connected to a MODbus network, the RD "BMS enabled" parameter must be set equal to "1" via the "RDM SETUP" screen on the Remote Display.

The same commands and registers are used to communicate with the Multi-zone directly or through the RD. If the communications are through the RD, it monitors each MODbus message to determine if the message is intended for one of the Multi-zone monitors it is connected to. If it is, the Remote display passes the message through to the Multi-zone monitors. If it is not, the message is not passed through.

The Remote display does not make any modifications to MODbus messages. It simply passes the query through to the Multi-zone monitor, and passes the response back to the MODbus master. In other words, it allows the Multi-zone monitors to be logically connected to the MODbus network, when physically they are connected to the local Remote display network.

	<p>IMPORTANT: it is very important to understand that the Remote display will only pass messages through to the Multi-zone monitor when the Remote display is either in the "SYSTEM" screen or the "ZONE VIEW" screen. If the Remote display is in any other screen, it will return a MODbus "busy" exception response (exception code 06)</p>
--	---

All Remote display screens, except the SYSTEM and ZONE VIEW screens, have a 10 minute timeout interval.

After this, the screen will return to the SYSTEM or ZONE VIEW screen, depending on which one was last displayed. The Remote display may also be password protected so that a password entry is required in order to view screens other than the SYSTEM or ZONE VIEW screen.

7.3.5 Key comm protocol parameters

Parameter	Description
MODbus Mode	RTU only
Multi-zone Baud Rate	Default is 19.200. Programmable as defined in system data register
Parity	No Parity
Stop Bits	Default is 1. Can be set for 2 via System data register
Maximum Response Time	4000ms when directly accessing the Multi-zone monitor 8.000ms when accessing the Multi-zone monitor through the RD
Error Checking	CRC per MODbus specifications

	<p>NOTE: all data sent out from the Multi-zone is in "little endian" byte order (Least significant byte followed by most significant byte). This should be taken into account if the master that process the data is a "big endian" type. Non-data information (starting address, number of points, etc.) follows normal MODbus protocol, which is Big Endian</p>
--	--

7.3.6 Summary of registers

Register Name Number	HEX	Decimal	Description
System Data	0x0010	16	R/W System Setup Data
Status	0x0011	17	R/W Operating summary of faults, alarms and status
Zone Data	0x12xx	4609-4630	R/W Setup data for up to 16 zones (xx defines zone number)
CAL Data	0x0014	20	R/W Cal Factors for all gases
Date/Time	0x0015	21	R/W Set Multi-zone date & time
Sensor Data	0x0016	22	R Raw measurement of sensors
Rel. Hold	0x0017	23	W Release Multi-zone out of hold mode
Hold Zone	0x0018	24	W Put Multi-zone into hold mode
Fault Log	0x19xx	6400-6401	R 20 most recent fault events (xx = 00 or 01)
Flow Log	0x001F	31	R 20 most recent flow fault events
Alarm Log	0x1Axx	6656-6658	R 20 most recent alarm events (xx = 00, 01, or 02)
Serv. Mode	0x001B	27	W Puts Multi-zone into service mode

Register Name Number	HEX	Decimal	Description
Rel Serv.	0x001C	28	W Release Multi-zone from service mode
PPM	0x001E	30	R PPM values for all zones
Zone Log	0x3yxx	0-6	Trend data for each Multi-zone [y = zone # (starting at 0), xx = 00 – 06] Data

Type	Abbreviations
C	Character
Float	Floating Point
I	Integer
TIM	Time
UI	Unsigned Integer

7.3.7 System data register 0x0010 (16 Dec) (R/W, 54 Bytes)

Variable	Type	Length	Description
Type	UI	2 bytes	Indicates EEPROM has been initialized if value = 300 DO NOT MODIFY
REV	Float	4 bytes	Firmware Rev Level DO NOT MODIFY
UNUSED	UI	2 bytes	Firmware Serial Number DO NOT MODIFY
Node	UC	1 byte	Network Slave Node # (valid values are 1-15). The default is that indicated by the Node DIP Switch on main board
Location	C	13 bytes	Array defining text name of unit
Stop_Bits	C	1 byte	Number of stop bits used in the Multi-zone data stream. Default = 1. Other available value is 2
Aud_Alarm	UC	1 byte	Sounds internal board buzzer on condition; 0 = no buzzer; 1= Alarm; 2=Fault; 3=Leak; 4=Spill; 5=Evacuate; 6=Monitor Off line (DEFAULT = 0)
Alarm_Ack_Mode	UC	1 byte	Defines Alarm Operation. Manual Acknowledge = 0; Auto Acknowledge = 1 (DEFAULT = 0)
Num_Zones	UC	1 byte	Number of install zones (Value initialized during auto detect during Power On Self Test)
UNUSED	TIM	13 bytes	UNUSED
Rezero_Mode	UC	1 byte	Defines re-zero mode. Auto Re-zero = 0; Re-zero every zone = 1 (DEFAULT = 0)
Hold_Time	UI	2 byte	Length of zone hold interval in minutes (DEFAULT = 15 minutes)
UNUSED	UC	1 byte	Minimum detection limit (in PPM). Concentrations less than or equal this value will read as 0 PPM (DEFAULT = 0 PPM)

Variable	Type	Length	Description
Avg_Size	UC	1 byte	Size of running average used in computing PPM value. DO NOT MODIFY
Loop2_factor	Float	4 bytes	Defines PPM current loop output. (DEFAULT = 0.16mA/PPM)
Serv_Mode_TO	UI	2 bytes	Service Mode Timeout value (in minutes). (DEFAULT = 60 MINUTES)
RS-485_BAUD	UI	2 bytes	BAUD RATE for RS-485 connection (between Remote display and Multi-zone monitor or MODbus master and Multi-zone depending on the Network topology). Default=9 (19.2K); other values are 8=9600, 7=4800
Mode	UI	2 bytes	UNUSED

**7.3.8 Status register 0x011
(17 Dec) (R/W, 10 Bytes)**

Variable	Type	Length	Description
Mode	UC	1 byte	Defines Operating Mode of Multi-zone. 0 = normal Mode; 1 = Zone_Hold Mode; 2 = Diagnostic Mode; 3 = Service mode. DO NOT MODIFY (use zone hold register or service mode register to change this parameter)
State	UC	1 byte	Defines Multi-zone Current State. 0 = Idle; 1 = Sampling; 2 = Zeroing; 3 = Warm Up; 4 = Pressure Check DO NOT MODIFY
Measuring	UC	1 byte	Value = 1 if unit is acquiring detector signal for running avg. DO NOT MODIFY
Active_Zone	UC	1 byte	Current Zone being checked. 0=zone 1; 1=zone 2, etc
Max_Alarm	UC	1 byte	Indicates highest non-acknowledged alarm level DO NOT MODIFY
Alarm_Count	UC	1 byte	Number of alarms that are currently active DO NOT MODIFY
UNUSED	UC	1 byte	UNUSED
Loop_Card	UC	1 byte	Value = 1 if 4-20 mA card has been detected DO NOT MODIFY
Fault	UI	2 bytes	Fault Flag Structure uses bitwise access to 16 bit word as defined in the table below

7.3.9 Fault code table

BIT	Fault Type	Code	Description
15	CLIPPING FAULT	0x8000	0x8000 Sensor output voltage too high
14	ZERO RANGE FAULT	0x4000	Sensor output voltage outside limits during purge
13	OVER RANGE FAULT	0x2000	Gas concentration above measurable range

BIT	Fault Type	Code	Description
12	PURGE FLOW FAULT	0x1000	No flow detected during purge cycle
11	ZONE FLOW FAULT	0x0800	No flow detected during sample cycle
10	A2D FAULT	0x0400	Analog to digital converter not working
9	GAIN SET FAULT	0x0200	Digipot gain setting out of normal range
8	ZERO FILTER FAULT	0x0100	Charcoal filter (if used) needs replacement
7	CONFIG FAULT	0x0080	No zones are enabled
6	UNUSED FAULT 2	0x0040	
5	UNUSED FAULT 1	0x0020	
4	LOOP FAULT	0x0010	Current loop is open
3	RS-485 FAULT	0x0008	Communications error
2	MANIFOLD P FAULT	0x0004	Pressure sensor readings are out of range
1	BENCH T FAULT	0x0002	Sensor temperature is out of range
0	BOX T FAULT	0x0001	Chassis temperature is out of range

7.3.10 Zone data register 0x12xx (R/W, 78 Bytes)

Each zone for an Multi-zone has a separate zone data structure that is 78 bytes long. The zone number is the low order byte in the register address (e.g., Zone 1 data register = 0x1201h).

Variable	Type	Length	Description
Location	C	13 bytes	13 byte array, Alpha Numeric Description or Name of Zone
Flow OK	UC	1 byte	Status of Flow check. Value of 1 indicates flow check is good. DO NOT MODIFY
Refrigerant Type	UC	1 byte	See note 1 Below (DEFAULT = R134a)
Distance	UI	2 bytes	Zone Tubing Length (in feet) (DEFAULT = 100ft [approx. 30.5 meters])
Zone Temp	I	2 bytes	Average temperature at zone (degrees C) (DEFAULT = 25°C)
Concentration	Float	4 bytes	Last Measured concentrations (uM/L) DO NOT MODIFY
Concentration2	Float	4 bytes	Last Measured concentration (PPM) DO NOT MODIFY
Alarm Ack	UC	1 bytes	 NOTE: Multi-zone will reset this byte to 0 when the Alarm byte (below) is = 0 and zone in alarm is sampled. If the alarm condition/byte increases (leak>>spill or spill>>evac) the Multi-zone will also reset this byte to 0
Alarm	UC	1 bytes	Alarm Status; 0 = no alarm; 1 = leak; 2 = spill; 3 = evac
Leak Level	UI	2 bytes	Level to trigger a leak alarm (in PPM) (DEFAULT = 100)
Spill Level	UI	2 bytes	Level to trigger a spill alarm (in PPM) (DEFAULT = 300)

Variable	Type	Length	Description
Evac Level	UI	2 bytes	Level to trigger a evacuate alarm (in PPM) (DEFAULT = 500)
Peak PPM	UI	2 bytes	Highest Recorded PPM in zone
Peak Time	TIM	13 bytes	Date and time of highest peak, (see note 2 for format)
Alarm Time	TIM	13 bytes	Date and time of last alarm, (see note 2 for format)
Alarm Ack/ Time		13 bytes	
Log Interval	UI	2 bytes	Number of minutes between Log entries (DEFAULT = 1440)

	NOTE: (see 6.0 "Appendix A")
	NOTE: time structure format consists of 13 unsigned character types. They are 1 second digit, 10 second digit, 1 minute digit, 10 minute digit, 1 hour digit, 10 hour digit, 1 day digit, 10 day digit, 1 month digit, 10 month digit, 1 year digit, 10 year digit, last byte is unused

7.3.11 Alarms and alarm acknowledge

The Multi-zone can be operated in two different alarm acknowledge modes, Auto and Manual (set via the alarm_ack_mode variable in the system data register). For purposes of this discussion, the term "Alarm" refers to an Multi-zone state where the alarm light is on and the appropriate alarm relay is activated. The term "Alarm condition" refers to the external condition (e.g. refrigerant leak) that initially causes the Multi-zone monitor to go into an alarm. If an alarm occurs it can be handled in one of 3 ways.

- 1. Non-latching mode:** this mode is enabled by setting the AUTO_ACK_MODE parameter in the system register to "1". In this mode, if an alarm condition occurs an Multi-zone alarm will be created. If the alarm condition is subsequently removed, the Multi-zone alarm will automatically be cleared by the Multi-zone monitor when the zone in alarm is sampled "clear".
NOTE: in this mode of operation, it is possible for an alarm to occur and be cleared without user or MODbus master intervention. If this is the case, the only evidence of the alarm would be contained in the Multi-zone alarm log
- 2. Latching mode with silence:** this mode is enabled by setting the AUTO_ACK_MODE in the system register to "0". In this mode, if an alarm condition occurs, an Multi-zone alarm will be created. In order for the alarm to be removed the MODbus master will write a "0" to the ALARM parameter in the ZONE register. This will cause the alarm to be "silenced" in the Multi-zone monitor (e.g. the alarm relays will return to their normal state and the ALARM lamp will be extinguished). The next time the zone with the alarm condition is sampled, if the alarm condition still exists, the alarm will be reactivated and the alarm parameter will be reset to "1" in the Multi-zone. Otherwise, if the alarm condition has cleared, no further action is required and normal operation will resume
- 3. Latching mode without silence:** This mode is enabled by setting the AUTO_ACK_MODE in the system register to "0". In this mode, if an alarm condition occurs, an Multi-zone alarm will be created. The Multi-zone MODbus master will then write a "1" to the ALARM ACK parameter in the zone register. The alarm will continue to persists (i.g., Relays in alarm state and Alarm light on) until the offending zone is sampled and no alarm condition is detected. At that point, the ALARM ACK parameter is automatically cleared by the Multi-zone monitor, as is the ALARM parameter

	NOTE: if the ALARM ACK parameter is set to "1" and the ALARM CONDITION is upgraded (from leak to spill, or spill to evacuate) the ALARM ACK parameter will automatically be cleared to "0" by the Multi-zone
--	---

**7.3.12 Date time register 0x0015
(21 Dec) (R/W, 14 Bytes)**

Variable	Type	Length	Description
Date_Time	Time	14 bytes	Contains current time and date. Structure is defined as in note 2 of zone data

Time structure format consists of 14 unsigned character types. They are 1 second digit, 10 second digit, 1 minute digit, 10 minute digit, 1 hour digit, 10 hour digit, a day digit, 10 day digit, 1 month digit, 10 month digit, 1 year digit, 10 year digit, day of the week, last byte is unused.

**7.3.13 Sensor data register
0x0016h (22 Dec)
(R, 82 Bytes)**

Variable	Type	Length	Description
Pressure	Float	4	Manifold Pressure is PSIA
P_Volts	Float	4	Pressure sensor output Voltage
Vacuum_P	Float	4	Pressure with all value closed and pump on in PSIA
Ambient_P	Float	4	Absolute Ambient Pressure in PSIA
Box_T	Float	4	Enclosure Temperature in Degrees C
Box_T_Volts	Float	4	Box temp sensor output voltage
Bench_T	Float	4	Optical bench temperature in Degrees C
Bench_T_Volts	Float	4	Bench temp sensor output voltage
Bench_Z_T	Float	4	Optical bench temp in degrees C at last zero interval
Box_Z_T	Float	4	Box temp in degrees C at last zeroing
PkPk_int	UI	2	Current peak to peak A/D counts from detector
PkPk	Float	4	Current peak to peak voltage from detector
Ave_PkPk	Float	4	Running average voltage from detector
Zero_PkPk	Float	4	Voltage measured at last zeroing
Noise	Float	4	Largest Change in running average
AU	Float	4	Current absorbance value
Ave_AU	Float	4	Running Average of absorbance level
Bench_PPM	Float	4	PPM in bench based on zone gas selection (uncorrected for pressure and temperature)
STP_PPM	Float	4	PPM corrected to STP (1 atm, 25°C)
Bench_UML	Float	4	Micromoles/liter in bench (uncorrected)
Ambient_UML	Float	4	Micromoles/liter corrected to ambient pressure

7.3.14 Release zone hold register
0x0017h (23 Dec)
(W, 10 Bytes)

Variable	Type	Length	Description
Rel_Hold			See description of STATUS REGISTER

7.3.15 Hold zone register
0x0018h (23 Dec)
(W, 10 Bytes)

Variable	Type	Length	Description
Zone_Hold			See description of STATUS REGISTER

7.3.16 Multi-zone hold mode

The Multi-zone monitor can be made to hold or "dwell" on a particular zone if necessary. The length of the hold time is defined by the HOLD TIME parameter in the system data register.

Placing the Multi-zone monitor into hold mode:

1. Read the Multi-zone status register (0x0011h)
2. Modify the content of the status register structure to change the MODE parameter to zone hold mode. Active zone parameter to the zone you wish to hold
3. Send this updated status register structure back to the Multi-zone using PRESET MULTIPLE REGISTER COMMAND to the HOLD ZONE REGISTER (0x0018h)

Releasing the zone hold:

1. Read the Multi-zone monitor status register (0x0011h)
2. Modify the content of the status register to change the MODE parameter to normal mode. Active zone parameter to the zone which you would like to resume normal activity on
3. Send this updated status register structure back to the Multi-zone using PRESET MULTIPLE REGISTER COMMAND to the RELEASE HOLD REGISTER (0x0017h)

7.3.17 Fault log register 0x1900-01
(6400-6401 Dec)
(R, 302 Bytes)

These registers contain the 20 most recent fault events, the time they occurred, and a pointer to the most recent event. The data is split into 2 registers. The first register contains 200 bytes and the second register contains 102 bytes. The results of these two register reads should be recombined into the Fault Log Data Structure after both have been received.

Variable	Type	Length	Description
Fault	UI	40 bytes	20 most recent fault events. Each event is decoded as indicated in Fault Flag Structure given after the Status Register Description
Time	TIM	260 bytes	Time of each fault occurrence. TIM value as defined in NOTE 2 of Zone Data
Ptr	UC	1 byte	Pointer to most recent event
Unused	UC	1 byte	Unused

7.3.18 Flow log register 0x001F
 (31 Dec) (R, 142 Bytes)

Variable	Type	Length	Description
Flow Event	UI	40 bytes	20 most recent flow fault events. Each bit of the unsigned int represents a zone and a 1 indicates no flow. Zero indicates flow
Purge Flow Event	UC	20 bytes	20 most recent flow fault events where a 1 indicates no flow. Zero indicates flow
Time	TIM	80 bytes	Time/date stamps for 20 most recent logged flow events. This variable is an unsigned long integer formatted as seconds since Jan 1 of 1980
Ptr	UC	1 byte	Pointer to most recent event
Unused	UC	1 byte	Unused

7.3.19 Alarm log register
0x1A00-02 (6656-58 Dec)
 (R, 582 Bytes)

These registers contain the 20 most recent alarm events, the time they occurred, and a pointer to the most recent event. The data is split into 3 registers and should be recombined into an appropriate structure after all three registers have been received. Register 0x1A00h contain 200 bytes, Register 0x1A01h contains 200 bytes, and register 0x1A02h contains 181 bytes.

Variable	Type	Length	Description
Event	UC	320 bytes	20 most recent alarm events. Each event contains 1 byte for each zone. Each zone Byte is defined as 0=No Alarm; 1=Leak Alarm; 2=Spill Alarm; 3=Evac Alarm
Time	TIM	260 bytes	Time of each alarm event. TIM value as defined in NOTE 2 of Zone Data
Ptr	UC	1 byte	Pointer to most recent event
Unused	UC	1 byte	Unused

7.3.20 Service mode register
0x001B (27 Dec)
 (W, 10 Bytes)

Variable	Type	Length	Description
Rel_Svc_Mode			See description of STATUS REGISTER

7.3.21 Release service mode
0x001C (28 Dec)
 (W, 10 Bytes)

Variable	Type	Length	Description
Ent_Svc_Mode			See description of STATUS REGISTER

7.3.22 Multi-zone service mode

The Multi-zone monitor can be placed into service mode if necessary. During service mode the unit will take no measurements, any and all alarms are silenced, and all relays are opened. The unit automatically comes out of service mode after a preset interval defined by the service_mode_TO parameter in the system data register.

Placing the unit into service mode:

1. Read the Multi-zone status register (0x0011h)
2. Modify the content of the status register structure to change the MODE parameter to service mode
3. Send this updated status register structure back to the Multi-zone unit using PRESET MULTIPLE REGISTER COMMAND to the SERVICE MODE REGISTER (0x001Bh)

Releasing the unit from service mode:

1. Read the Multi-zone status register (0x0011h)
2. Modify the content of the status register to change the MODE parameter to normal mode
3. Send this updated status register structure back to the Multi-zone unit using PRESET MULTIPLE REGISTER COMMAND to the RELEASE SERVICE MODE REGISTER (0x001Ch)

7.3.23 PPM register 0x001E (30 Dec) (R, 32 Bytes)

Variable	Type	Length	Description
PPM	UI	32 bytes	16 Unsigned Integers that represent the PPM values for each Multi-zone monitor zone



NOTE: 16 values are returned independent of the number of actual zones installed in the unit. The master device is required to know how many zones are installed in the unit (available in the system register) in order to properly interpret the data

7.3.24 Zone log registers 0x3xyy (R, 1502 Bytes)

These registers are used to transfer the zone log data. Each zone has a circular log of 100 past data points. The period between data points is defined by the Log Interval parameter in each corresponding Zone Data Register. The data for each zone is defined by the "x" place in the above register address. For zone 1 the Register address is 0x30yyh, for zone 2 the register address is 0x31yyh, etc.

The data for each zone is sent in 8 consecutive registers due to MODbus RTU message length constrains. The addresses are defined by the "yy" place in the above address.

For zone 1, all log data can be obtained by reading 0x3000h, 0x3001h, 0x3002h, , 0x3007h.

The first seven registers contain 200 bytes each and the last register contains 102 bytes.

After all registers have been received the data should be reassembled into the full data structure.

Variable	Type	Length	Description
Index	UI	2	Point to current reading
Time	TIM	1300	Time record for each of the 100 log points. The format for the TIM type is defined in note 2 of zone data
PPM	UI	200	Last 100 log points (2 bytes per point)

7.3.25 MODbus exception responses

The following MODbus exception responses are supported by the unit.

- 01 Illegal Function.
- 02 Illegal Data Address.
- 03 Illegal Data Value.
- 06 Slave Device Busy.
(Occurs only when Multi-zone is connected to the bus through an Remote display and the Remote display is not in the SYSTEM or ZONE VIEW screen).

7.3.26 MODbus gas enumeration

The following table provides decimal and hexadecimal MODbus enumerations for supported refrigerant.

Refrigerant Gas	DEC	HEX	Refrigerant Gas	DEC	HEX
CO ₂ /R-744	0	00	R508B	21	15
NH ₃ /R-717	0	00	H1301	22	16
R11	0	00	R408A	23	17
R12	1	01	FA188	24	18
R22	2	02	R236FA	25	19
R23	3	03	N1230	26	1A
R113	4	04	R227	27	1B
R114	5	05	HFP	28	1C
R123	6	06	FC72	29	1D
R124	7	07	R21	30	1E
R134A	8	08	R125	31	1F
R401A	9	09	H1211	32	20
R402A	10	0A	H2402	33	21
R402B	11	0B	R245FA	34	22
R404A	12	0C	R422A	35	23
R407A	13	0D	R422D	36	24
R407C	14	0E	R427A	37	25
R409A	15	0F	H1234YF	38	26
R410A	16	10	R424A	39	27
R500	17	11	R426A	40	28
R502	18	12	R438A	41	29
R503	19	13	R32	42	2A
R507	20	14			

8.0 APPENDIX C

Multi-zone system map

Sample setup screen

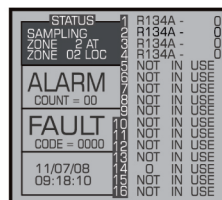

Navigating to a zone:

- Select the zone in the list on the status screen & press ENTER
- or
- Select ZONES on the 1st setup screen

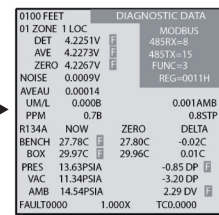
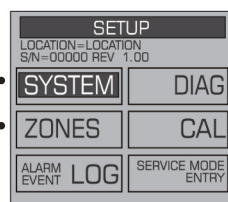
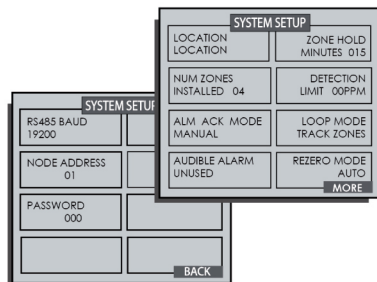

Access via service mode

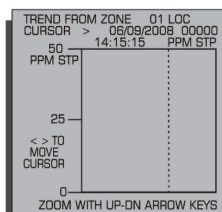
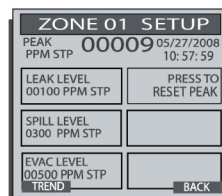
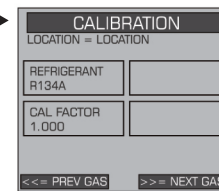
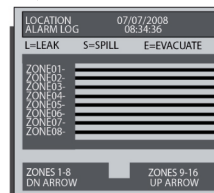
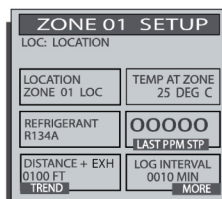
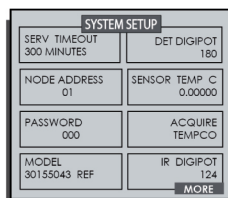

Multi-zone system map Sample alarm and fault screen

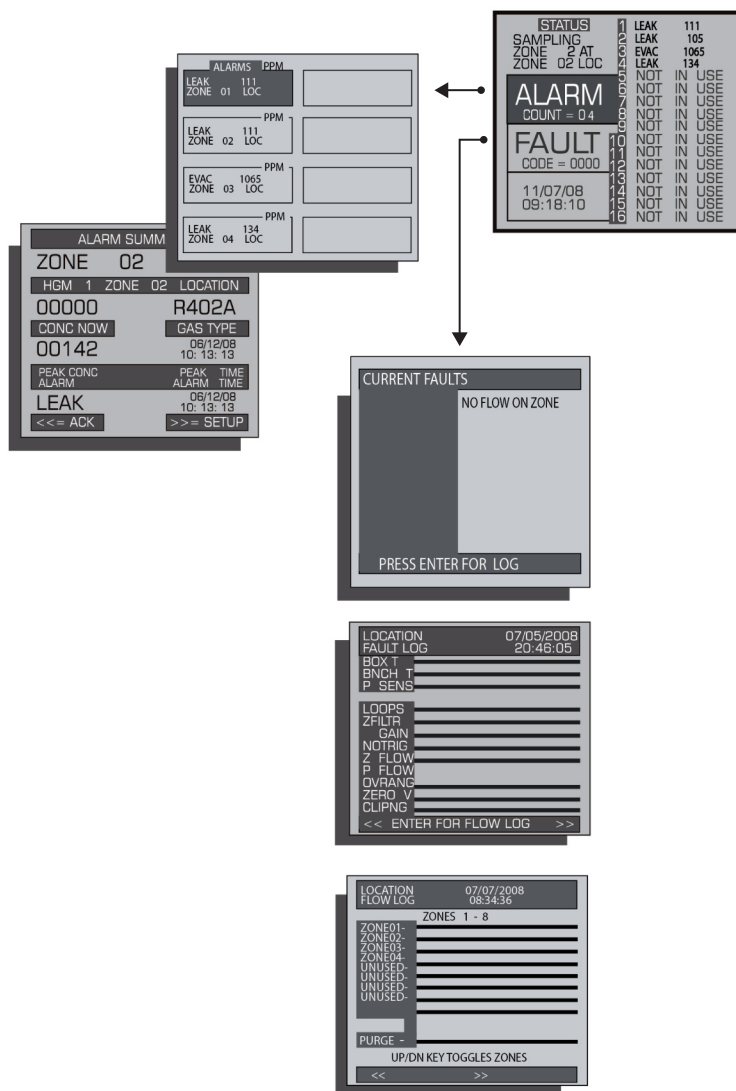

Navigating to a zone:
 - Select the zone in the list on the status screen & press ENTER
 or
 - Select ZONES on the 1st setup screen

9.0 Replacement parts & optional accessories

Replacement Parts

Part Number	Item Description
080Z2151	HGM-400 - 8 ZONE LEAK DETECTOR
080Z2152	HGM-400 - 12 ZONE LEAK DETECTOR
080Z2153	HGM-400 - 16 ZONE LEAK DETECTOR

Optional Accessories

Part Number	Item Description
080Z2198	Hydrophobic Filter
080Z2199	Line End Dust Filter
C01703200	250 Foot Roll of Tubing (sold per roll)
C01680417	Charcoal Filter
C01680421	HGM Line End Filter
*	Installation kit
*	Management kit

* The part number changes according to the region, please contact you local Danfoss office

Please contact your local Danfoss office for further information