

Installation guide

Thermostat

Types KP 61 - KP 81

060R9748

060R9748

KP 61, KP 62, KP 63, KP 68, KP 69 vapor charge
 KP 71, KP 73, KP 75, KP 77, KP 79, KP 81 adsorption charge (cross ambient)

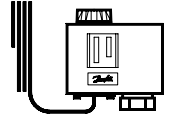

Types

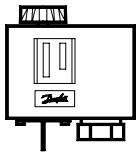

Auto reset

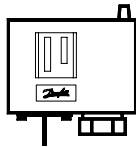

Manual reset
(w/o hand knob)

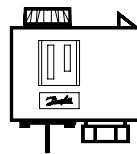

Auto reset
w/ hand switch

Bulb types

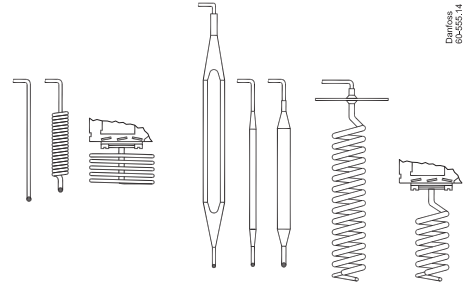

Vapor charge

Adsorption charge

Danfoss
60-555.14

Mounting requirement

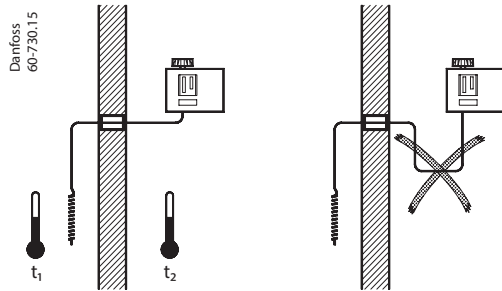

Vapor charge

$$t_2 \geq t_1 + 2^\circ\text{C} (3.5^\circ\text{F})$$

Max. bulb temperature



Vapor charge

KP 61, KP 62, KP 63 Max. : 120 °C (250 °F)
 KP 68, KP 69

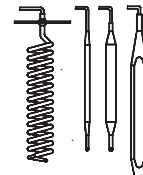

Adsorption charge

KP 71, KP 73: 80 °C (175 °F)
 KP 75 : 110 °C (230 °F)
 KP 77 : 130 °C (265 °F)
 KP 79 : 150 °C (300 °F)
 KP 81 : 200 °C (390 °F)

Danfoss
60-731.14

Ambient temperatures



min. -40 °C (-40 °F)
 max. 65 °C (150 °F)

Danfoss
60-732.12

Enclosure



CAUTION: The mounting panel must be plane to avoid damage of control.

Danfoss
60-733.12

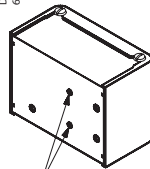

10 - 32 UNC

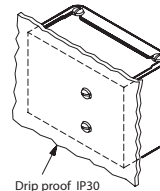

Drip proof IP30
(EN 60529)

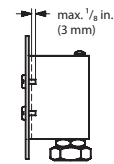

max. 1/8 in.
(3 mm)

Cable entry

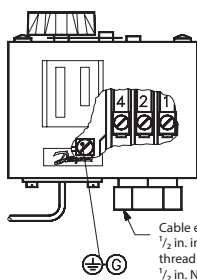

Danfoss
60-733.12

Cable entry
1/2 in. int.
thread accepts
1/2 in. NPT or NPS

Required cap. tube length on evaporator

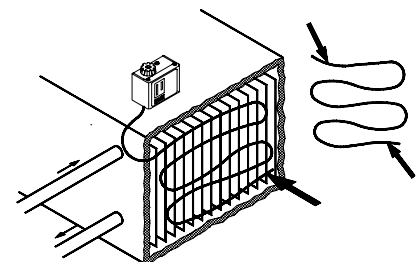

DANFOSS
AOC-794.12

80 in. cap. tube: min. 16 in.
 196 in. cap. tube: min. 22 in.

Wiring



CAUTION: Disconnect power supply before wiring connections are made to avoid possible electrical shock or damage to equipment.

All wiring should conform to the National Electrical Code and local regulations.

Terminal block

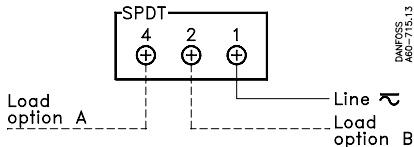

CAUTION: Use terminal screws furnished in the contact block. Use tightening torque 20 lb. in. (2.3 Nm). Use copper wire only.

Contact load ratings

120V a.c.	16 FLA, 96 LRA
240V a.c.	8 FLA, 48 LRA
240V d.c.	12W pilot duty

Load Option A

CUT-OUT on temperature drop
Wire terminals 1 - 4:
CUT-IN = High Set Point (HSP) see "Setting"
CUT-OUT = Low Set Point (LSP) see "Setting"

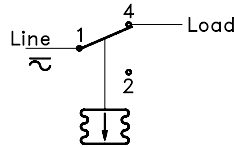

Terms 1 - 4 close on temperature rise
Terms 1 - 4 open on temperature drop

Example: CUT-IN = 10 °C (50 °F)
CUT-OUT = 4.5 °C (40 °F)

This means
CUT-IN = HSP = 10 °C (50 °F)
and
CUT-OUT = LSP = 4.5 °C (40 °F)

Note:

= Bellows movement on pressure rise
 = Bellows movement on pressure drop
The free terminal can be used for signal purpose.

Load Option B

CUT-OUT on temperature rise
Wire terminals 1 - 2:
CUT-IN = Low Set Point (LSP) see "Setting"
CUT-OUT = High Set Point (HSP) see "Setting"

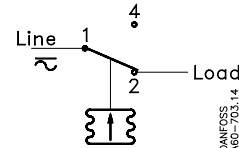

Terms 1 - 2 close on temperature drop
Terms 1 - 2 open on temperature rise

Example: CUT-IN = 0 °C (32 °F)
CUT-OUT = 10 °C (50 °F)

This means
CUT-IN = LSP = 0 °C (32 °F)
and
CUT-OUT = HSP = 10 °C (50 °F)

Manual tripping (Electrical contacts/wiring test)

Note:
use FINGERS ONLY!
(Do NOT use screwdriver)

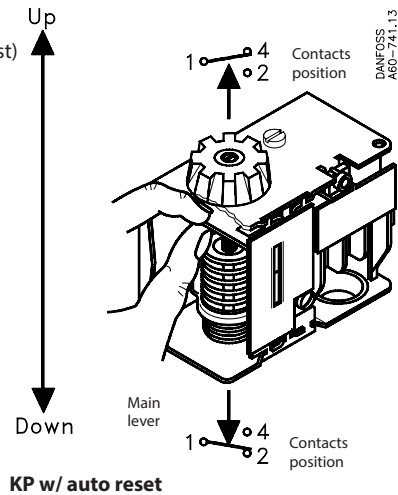

KP w/ auto reset

Note:
use FINGERS ONLY!
(Do NOT use screwdriver)

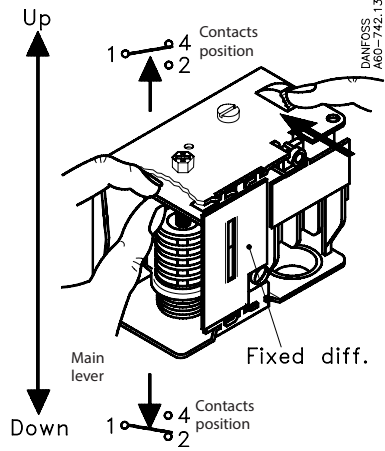

KP w/ manual reset

Note:
Push manual reset knob during manual tripping.

Manual reset

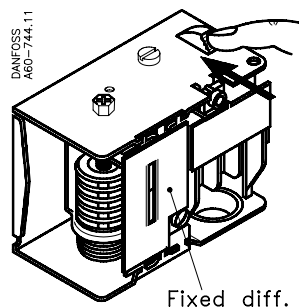

To resume control operation after safety cut-out, push reset knob as indicated.

Note:
Man. reset is possible only after a temperature rise of fixed differential (example 5.4 °F)

Adjustment spindles location

Note

Remove lockplate before thermostat adjustment. Replace lockplate after adjustment (if desired).

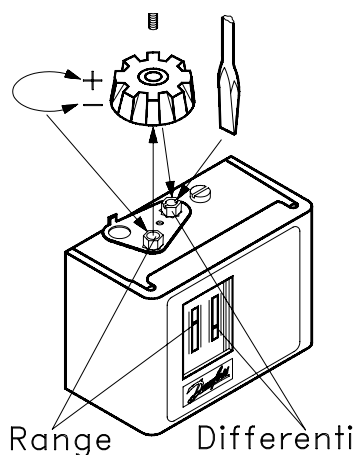

RANGE

See printed instruction on top of control

- increase temp. (warmer): turn CW
 - decrease temp. (colder): turn CCW
- (use adjustment knob)

DIFFERENTIAL

See printed instruction on top of control

- Increase: turn CW
 - decrease: turn CCW
- (use adjustment knob or screwdriver)

Determination of differential

For KP w/ vapor charge and auto. reset (KP 61, KP 62, KP 63, KP 68, KP 69): Use graphs to determine correct differential.

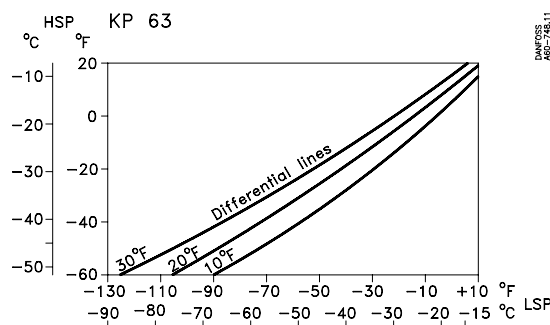
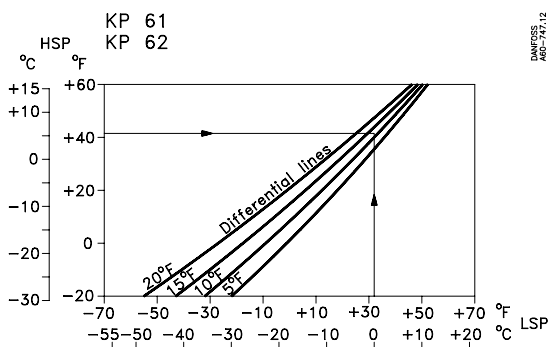

Example:
HSP = 5.6 °C (45 °F) => DIFF (from graph):
LSP = 0 °C (32 °F) 7.2 °C (13 °F) (value which has to be set on diff. scale).

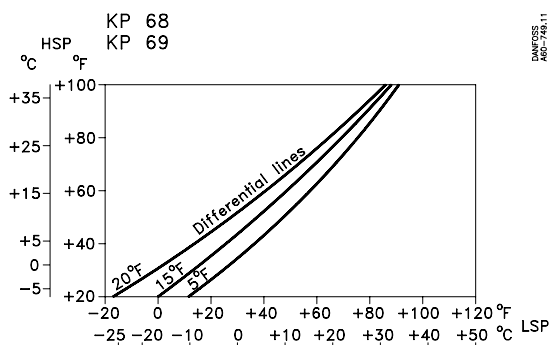

For KP w/ adsorption charge (KP 71, KP 73, KP 75, KP 77, KP 79, KP 81):
The differential will be HSP less LSP

Example: HSP - LSP = DIFF.
7 °C - 5 °C = 2 °C
(45 °F)(35 °F) (10 °F)

Note:
(Load Option A) (Load Option B)
CUT-IN = HSP or CUT-IN = LSP
CUT-OUT = LSP CUT-OUT = HSP
See "Wiring"

Setting

For KP 61, KP 62, KP 63, KP 68, KP 69, KP 71, KP 73, KP 75, KP 77, KP 79 and KP 81 w/auto reset

KP 61 and KP 71 w/man. reset

1. Adjust range spindle to desired HIGH SET POINT (use hand knob)
2. Adjust differential spindle to desired DIFFERENTIAL

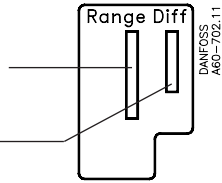

1. Adjust range spindle to desired LOW SET POINT
2. DIFFERENTIAL is fixed. Value printed on scale plate

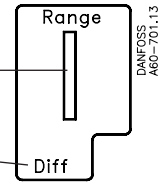

Note:

To find correct differential, see "Determination of differential"

HIGH SET POINT minus DIFFERENTIAL equals LOW SET POINT

Example:
 HSP - DIFF. = LSP
 7 °C - 5 °C = 2 °C
 (45 °F) - (10 °F) = (35 °F)

HIGH SET POINT minus DIFFERENTIAL equals LOW SET POINT

Example:
 HSP - DIFF. = LSP
 3 °C - 3 °C = 0 °C
 (37.4 °F) - (5.4 °F) = (32 °F)

KP w/ hand switch



CAUTION:

- Hand switch breaks circuit by micro contact gab.
- Use hand switch for service on refrigeration parts only
- Cut out main switch before service on electrical parts

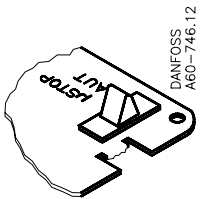

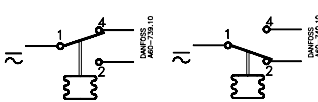
Switch position	Contacts position
Aut.	Automatic control operation 
µ Stop	1 and 2 are closed 