



Electrical installation instructions

**Danfoss Heat Pumps
DHP-L**

Contents

DHP-L 4, 400V 3N	3–5
DHP-L 6, 400V 3N	6–8
DHP-L 8, 400V 3N	9–11
DHP-L 10, 400V 3N.....	12–14
DHP-L 12, 400V 3N.....	15–17
DHP-L 16, 400V 3N.....	18–20
DHP-L 4 SP, 230V 1N.....	21–23
DHP-L 6 SP, 230V 1N.....	24–26
DHP-L 8 SP, 230V 1N.....	27–29
DHP-L 10 SP, 230V 1N	30–32
DHP-L 12 SP, 230V 1N	33–35
DHP-L Opti 6, 230V 1N	36–39
DHP-L Opti 8, 230V 1N	40–43
DHP-L Opti 10, 230V 1N.....	44–47
DHP-L Opti 12, 230V 1N.....	48–51
DHP-L Opti 6, 400V 3N	52–55
DHP-L Opti 8, 400V 3N	56–59
DHP-L Opti 10, 400V 3N.....	60–63
DHP-L Opti 12, 400V 3N.....	64–67
DHP-L Opti 16, 400V 3N.....	68–71

Electrical installation

Danfoss heat pumps are factory-wired internally. The leads that are to be connected are the mains supply (5-wire DPH), outdoor temperature sensor and room sensors (if any).

- All electrical wiring must be carried out by a certified electrician in compliance with local and national codes and regulations. When in doubt, contact the local electricity distributor.
- The mains lead is passed through the top of the unit.
- Remove the front panel to get access to the terminal blocks. Connect the mains lead to the terminal block according to the accompanying schematic diagram.
- The connection of the heat pump to the mains supply must be hard-wired and a multi-pole switch (safety switch) must be installed in the power supply line to the unit.

WARNING! To disconnect the power supply to the heat pump, the safety switch must be switched off.

NOTE! The cables to the outdoor and indoor sensors carry low voltage. Interference from surrounding cables may affect these and cause incorrect information to be sent to the control unit. It is therefore vitally important that careful consideration be given to positioning of cables. Low-voltage cables must be kept well separated from high-voltage cables. It is important that low-voltage cables are run parallel to high-voltage cables and separated by a distance of at least 25 cm for cable lengths up to 100 m. For longer cable lengths, the distance between cables should be increased.

Important information

Before switching on the power supply to the heat pump, you must ensure that the heating system, chilled water line and hot water heater are filled and vented. Otherwise, the circulation pumps can be severely damaged.

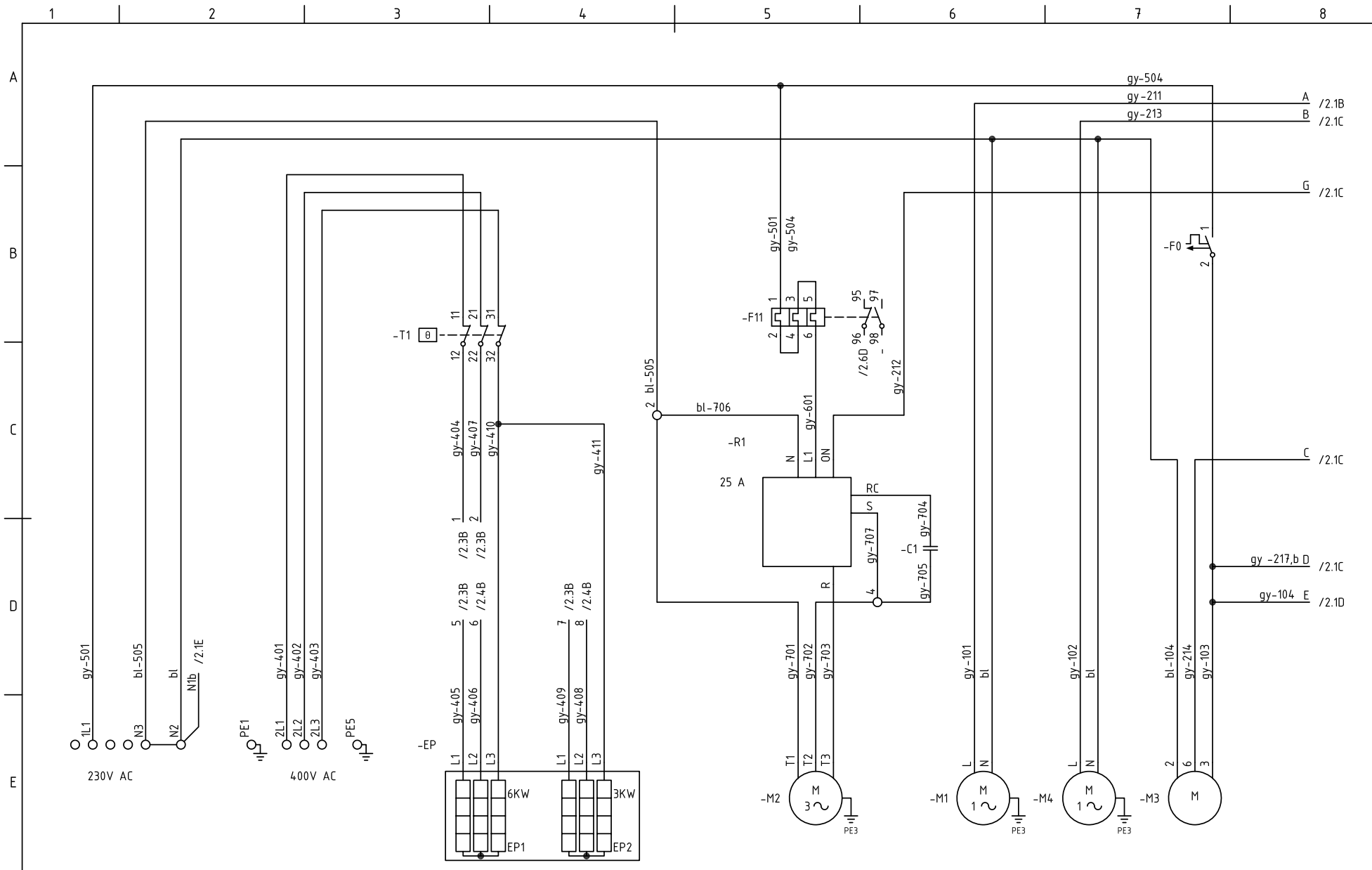

- bk black
- bn brown
- gy grey
- bl blue
- wh white
- rd red

Note! Can be connected to 230V single phase if auxiliary heater is disconnected.

Auxiliary heater

Compressor

Pump Brine

Pump circulation

Reversing valve
Hot-water

	=VP +A	APPROVED AL	CREATED BY Stb	REVISION 4	DATE 090512	
		DHP-L 4 400V 3N Circuit diagram			CONTINUED 2	SHEET 1
		DRAWING NR. 086U0760				

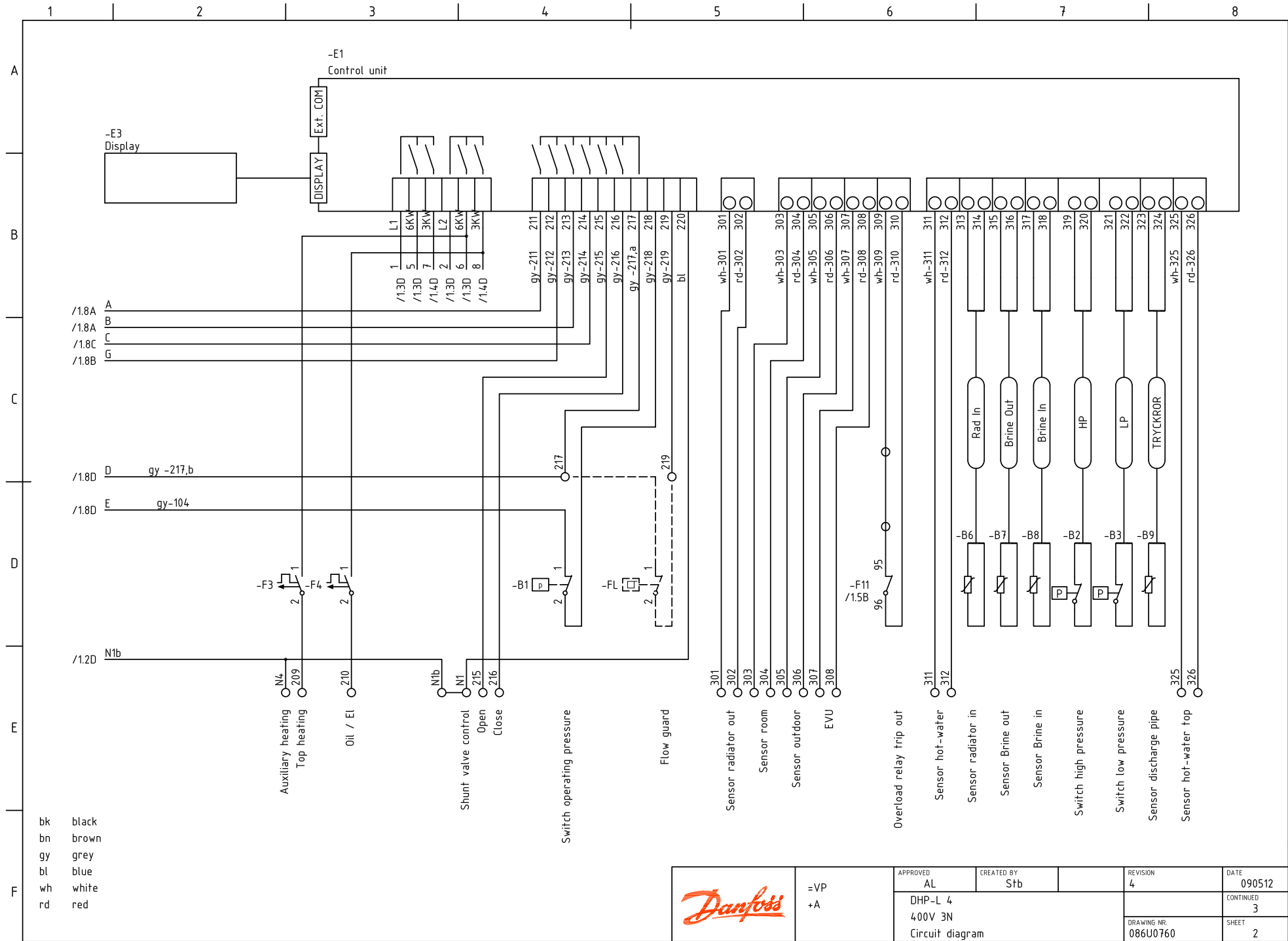

	=VP +A	APPROVED AL	CREATED BY Stb	REVISION 4	DATE 090512	
		DHP-L 4 400V 3N Circuit diagram			CONTINUED 3	SHEET 2
					DRAWING NR. 086U0760	

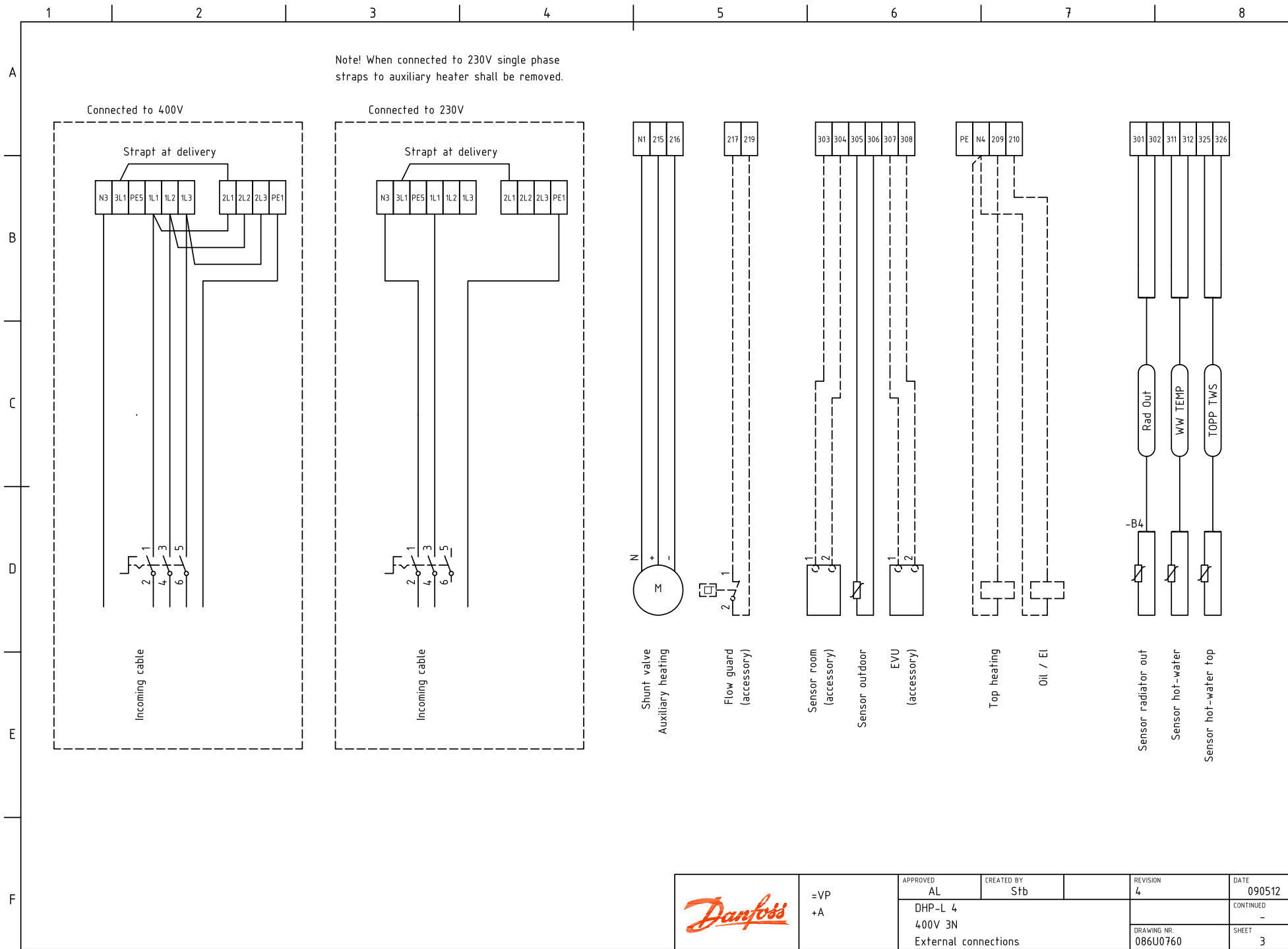

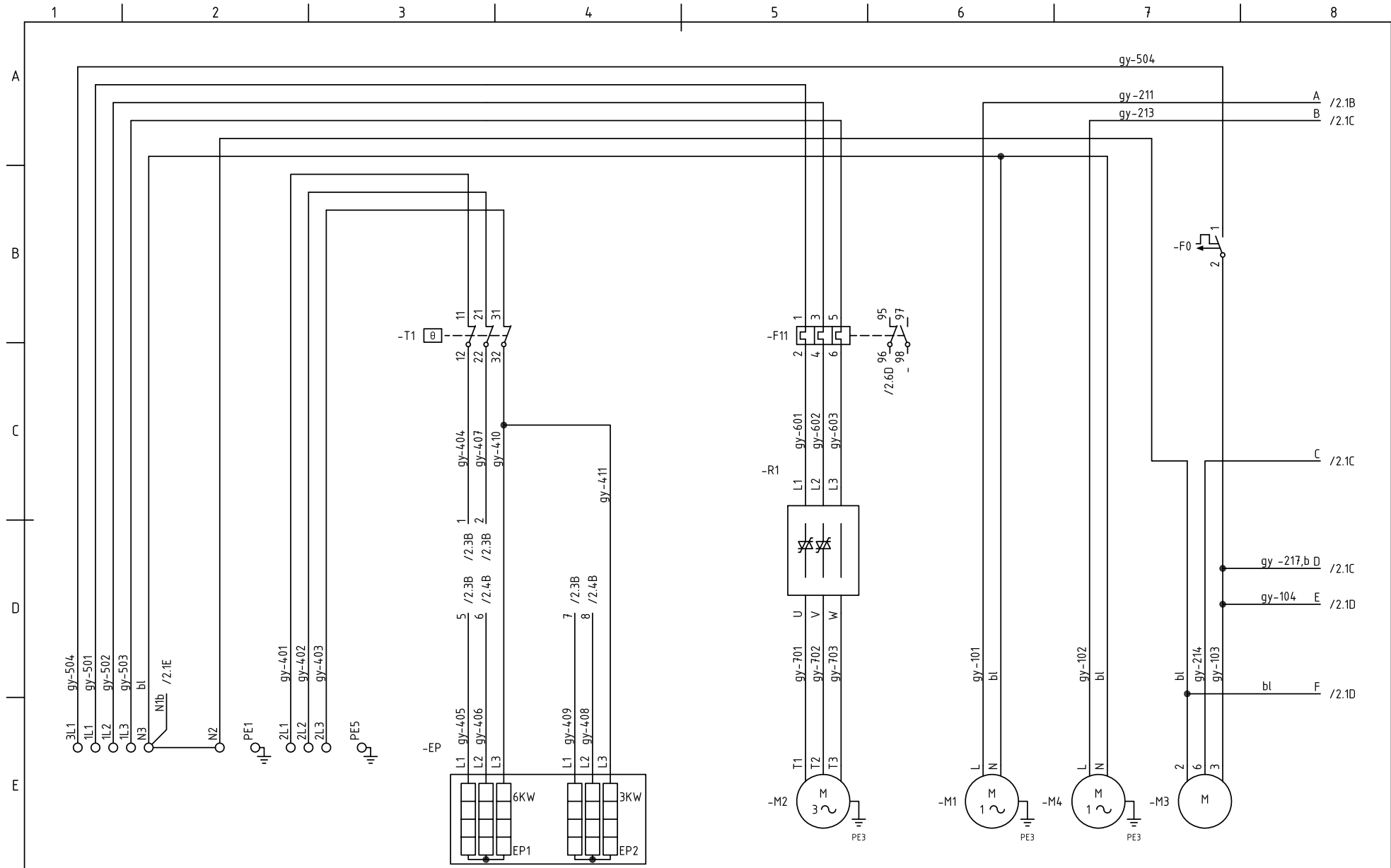

- bk black
- bn brown
- gy grey
- bl blue
- wh white
- rd red

Auxiliary heater

Compressor

Pump Brine

Pump circulation

Reversing valve
Hot-water

	=VP +A	APPROVED Stb	CREATED BY Stb	REVISION 5	DATE 090512	
		DHP-L 6 400V 3N Circuit diagram			CONTINUED 2	SHEET 1
		DRAWING NR. 086U0761				

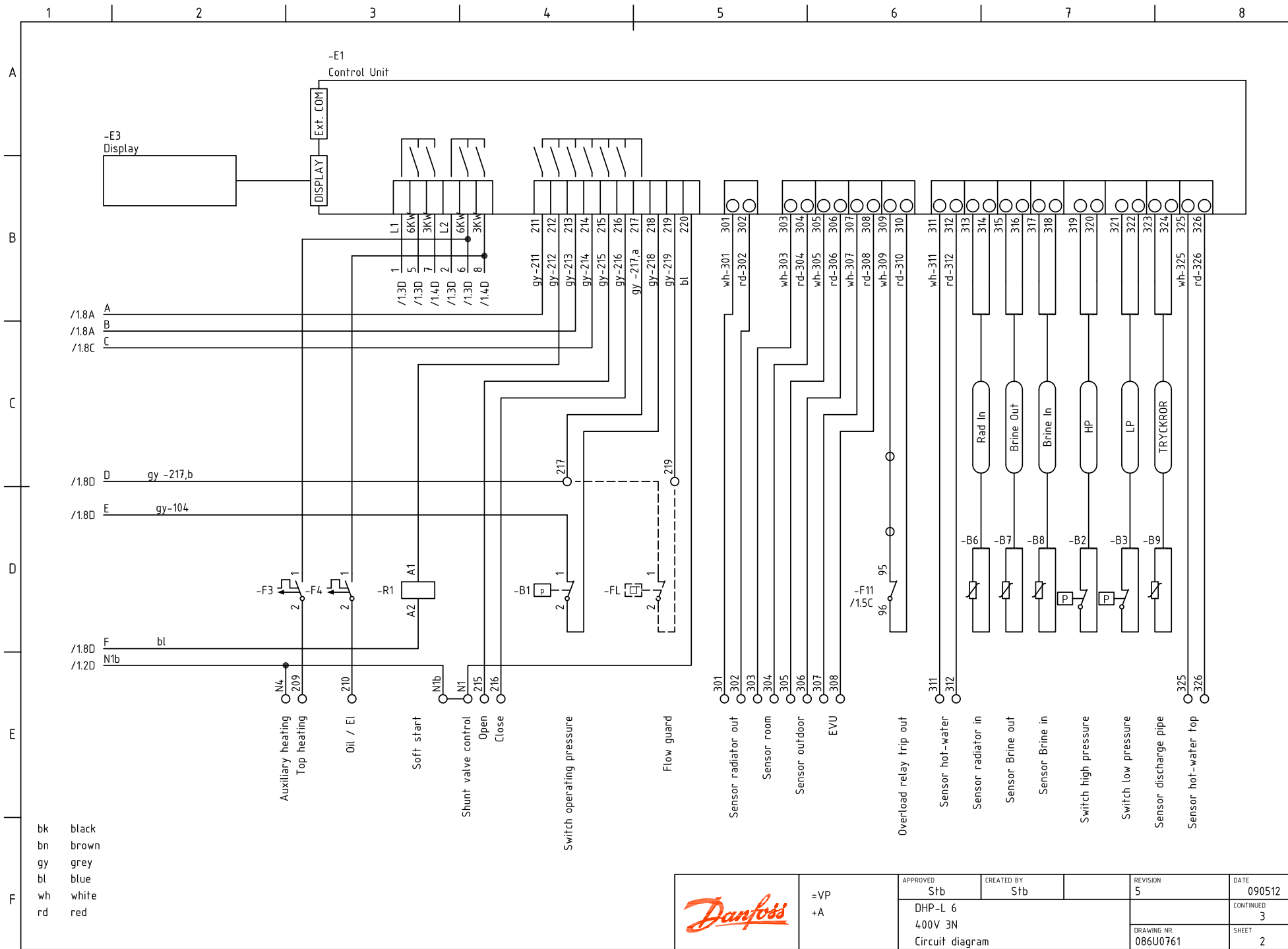

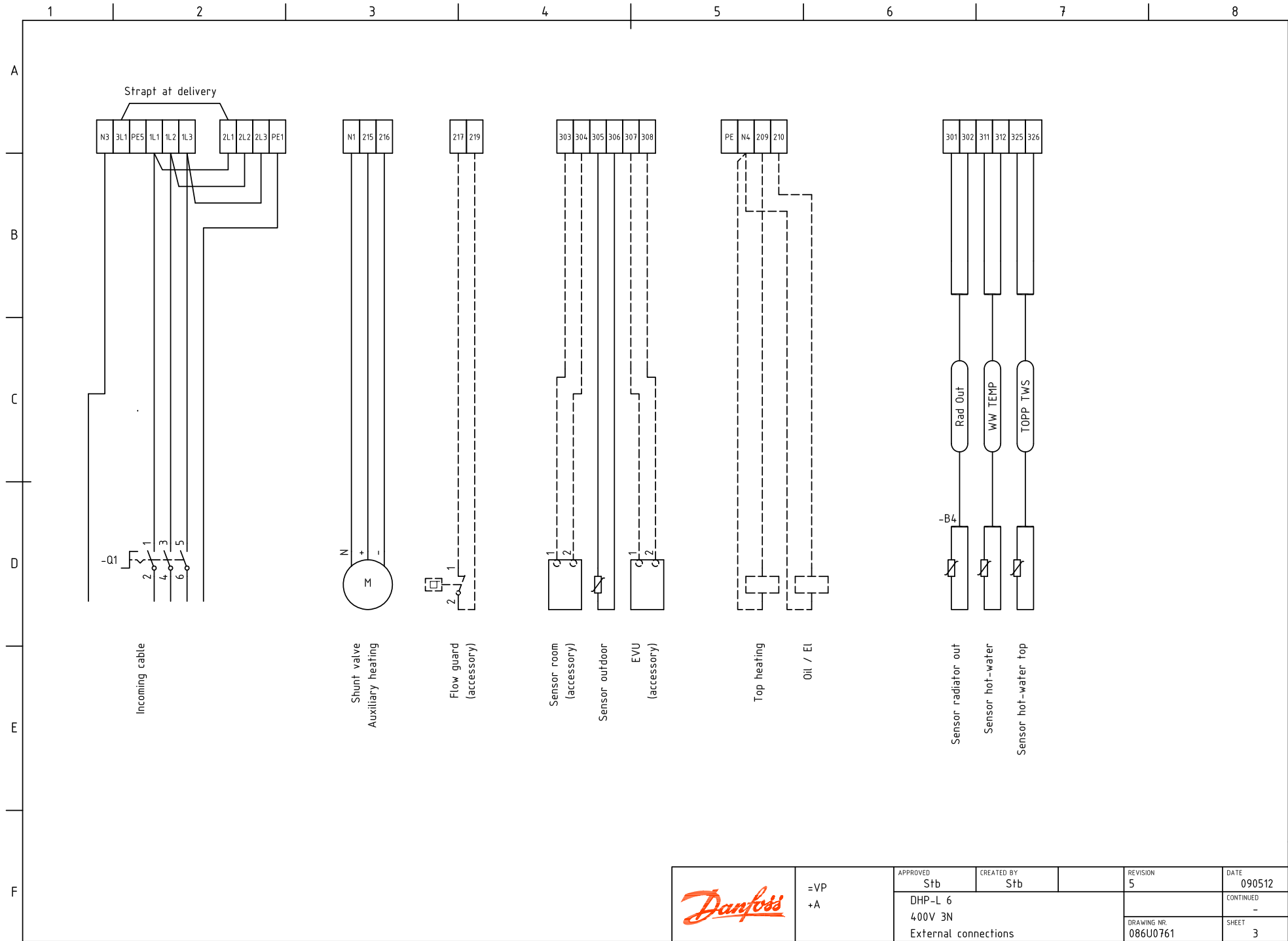

	=VP +A	APPROVED Stb	CREATED BY Stb	REVISION 5	DATE 090512	
		DHP-L 6 400V 3N External connections				CONTINUED -
					DRAWING NR. 086U0761	SHEET 3

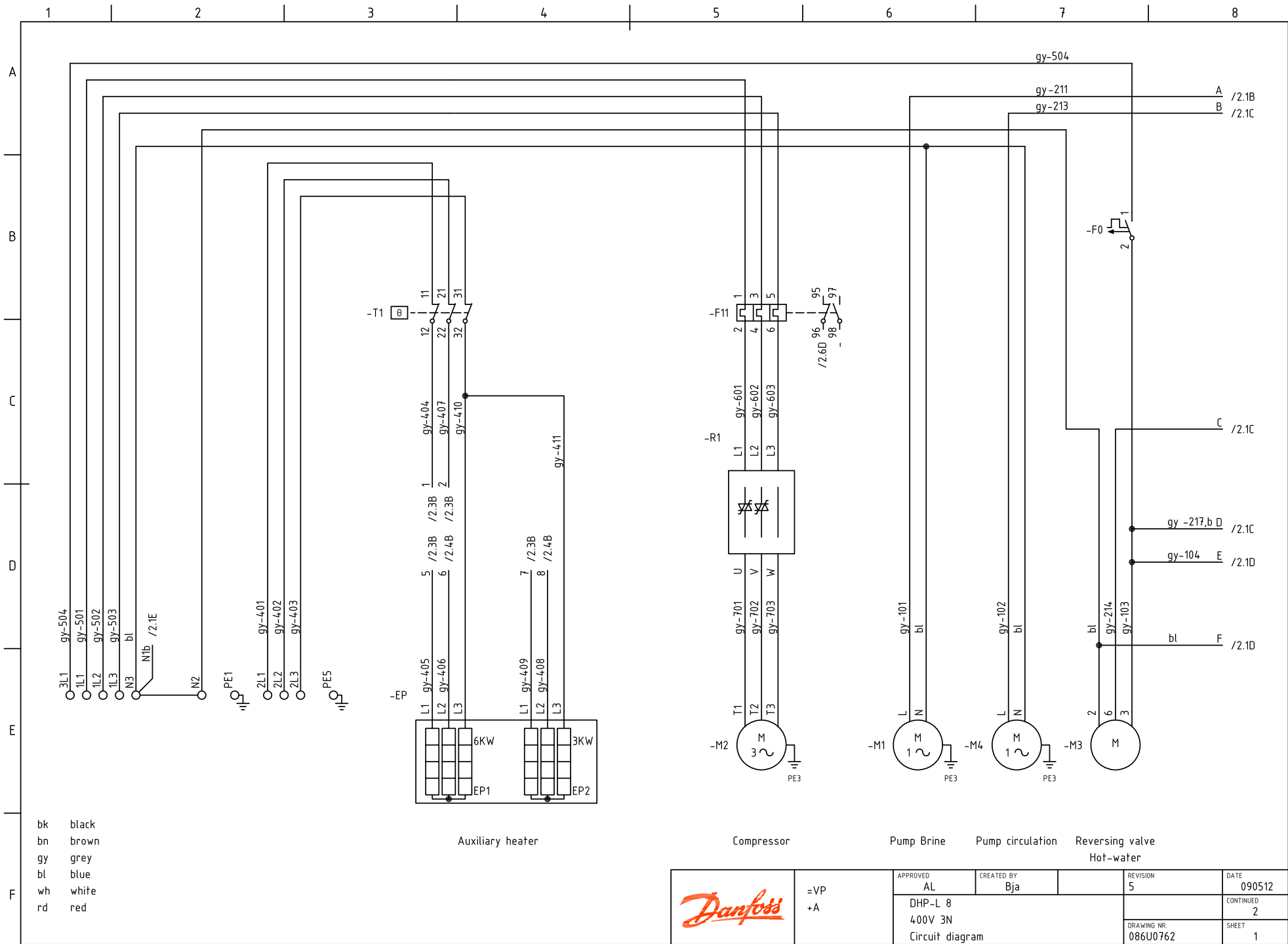

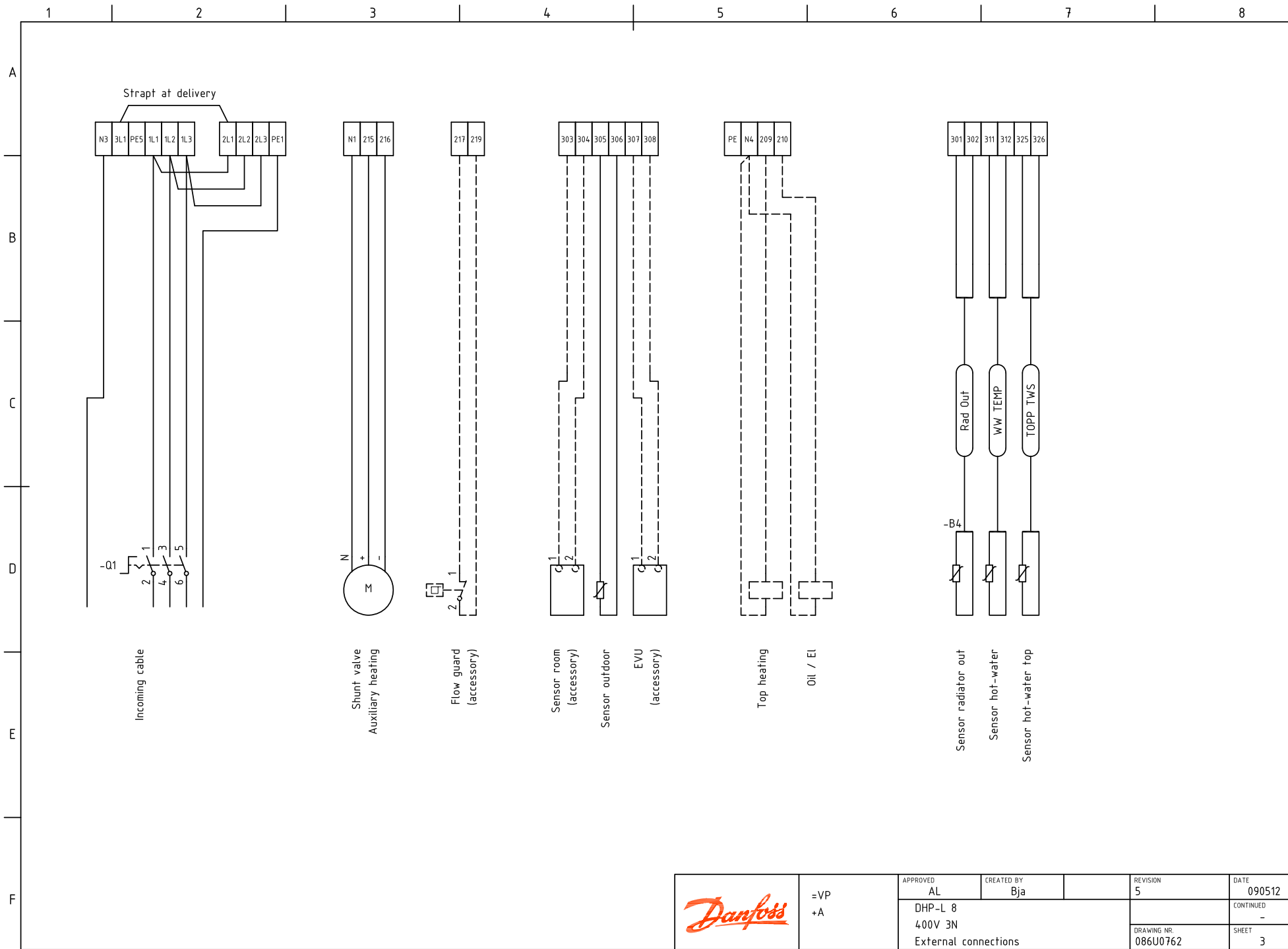

Incoming cable

Shunt valve
Auxiliary heating

Flow guard
(accessory)

Sensor room
(accessory)

Sensor outdoor

EVU
(accessory)

Top heating

Oil / EI

Sensor radiator out

Sensor hot-water

Sensor hot-water top

	=VP +A	APPROVED AL	CREATED BY Bja	REVISION 5	DATE 090512	
		DHP-L 8 400V 3N External connections				CONTINUED -
					DRAWING NR. 086U0762	SHEET 3

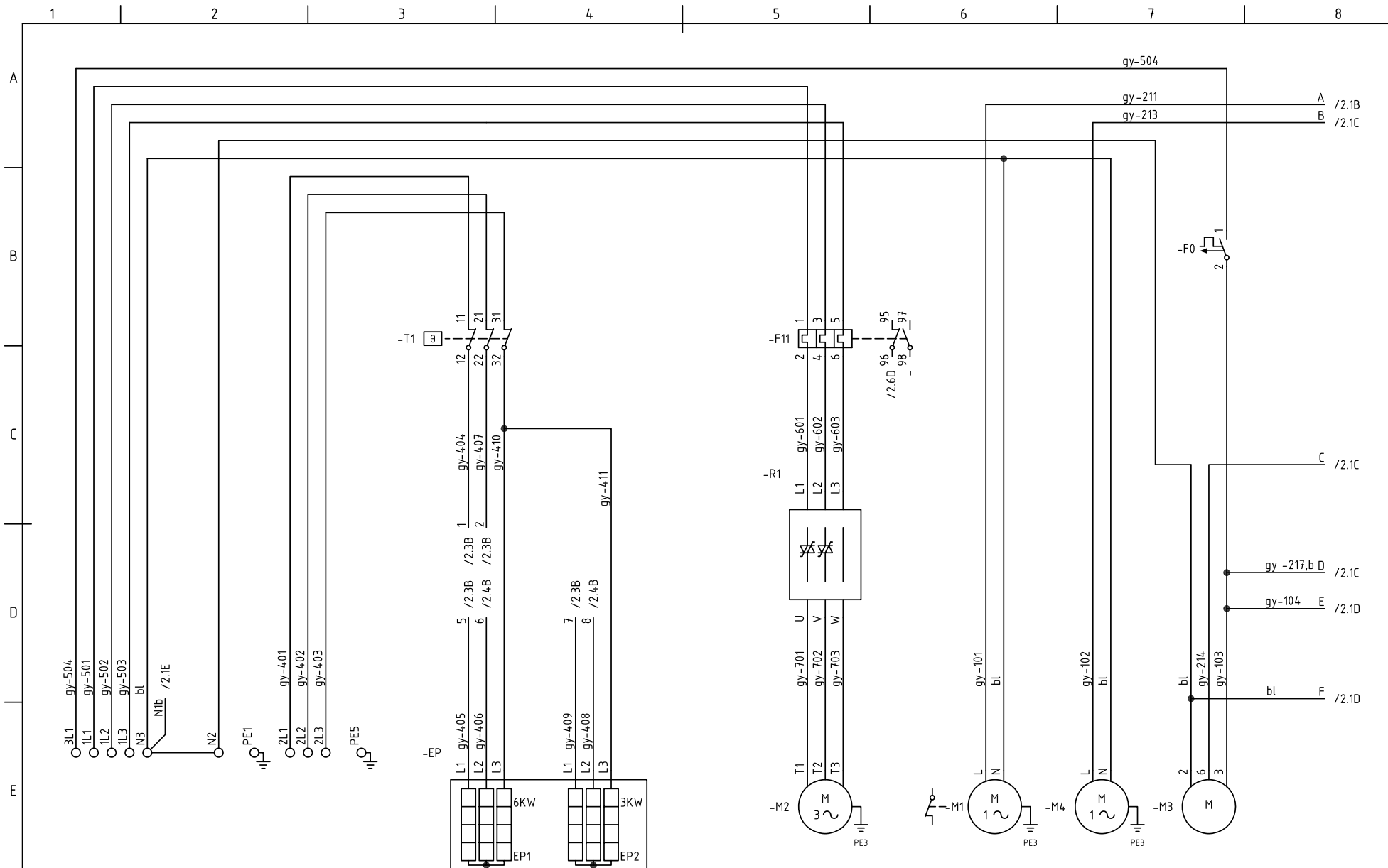

- bk black
- bn brown
- gy grey
- bl blue
- wh white
- rd red

Auxiliary heater

Compressor

Pump Brine

Pump circulation

Reversing valve

Hot-water

	=VP +A	APPROVED AL	CREATED BY Stb	REVISION 5	DATE 090512	
		DHP-L 10 400V 3N Circuit diagram				CONTINUED 2
		DRAWING NR. 086U0763				SHEET 1

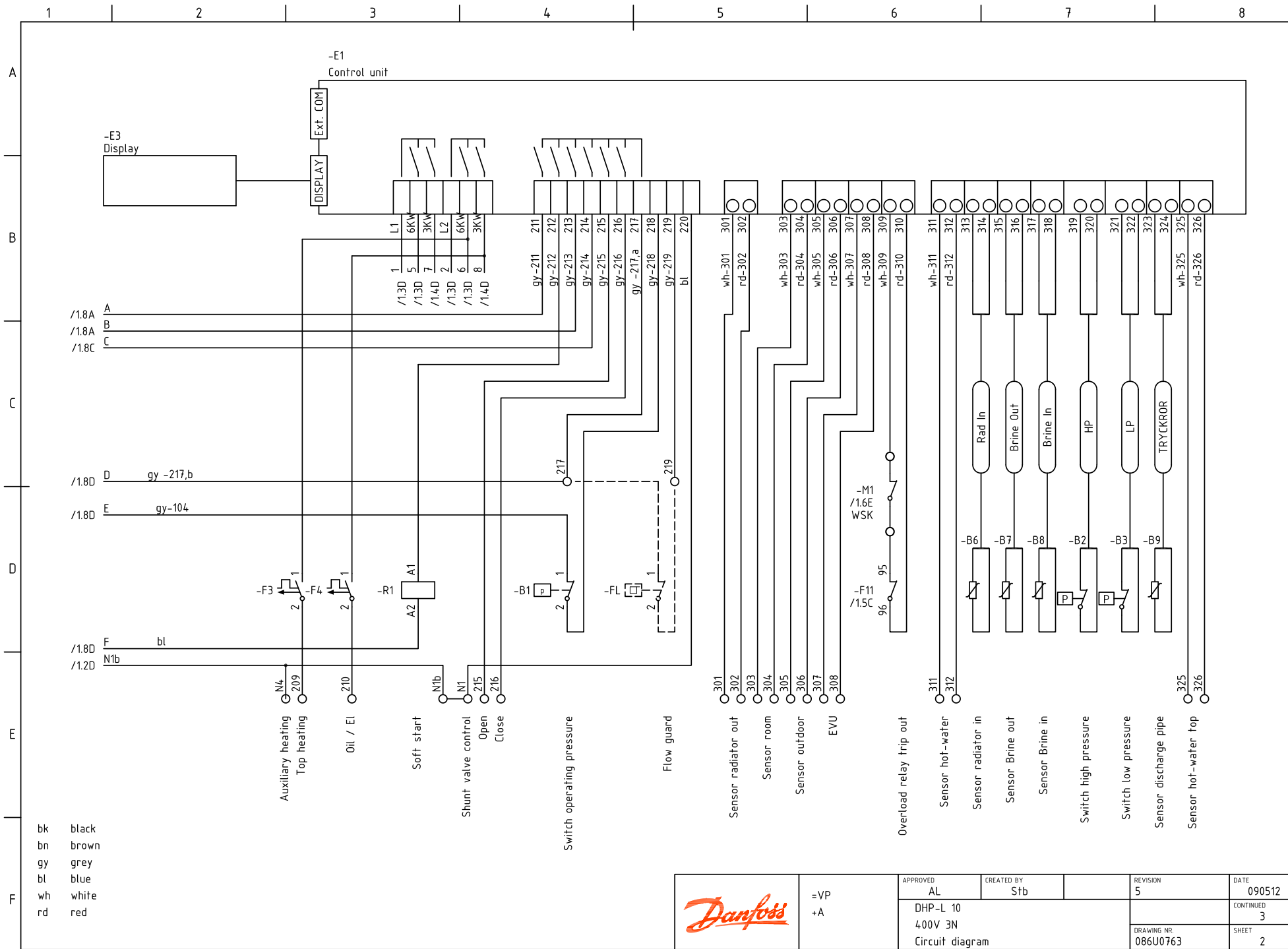

	=VP +A	APPROVED AL	CREATED BY Stb	REVISION 5	DATE 090512	
		DHP-L 10 400V 3N Circuit diagram			CONTINUED 3	SHEET 2
					DRAWING NR. 086U0763	

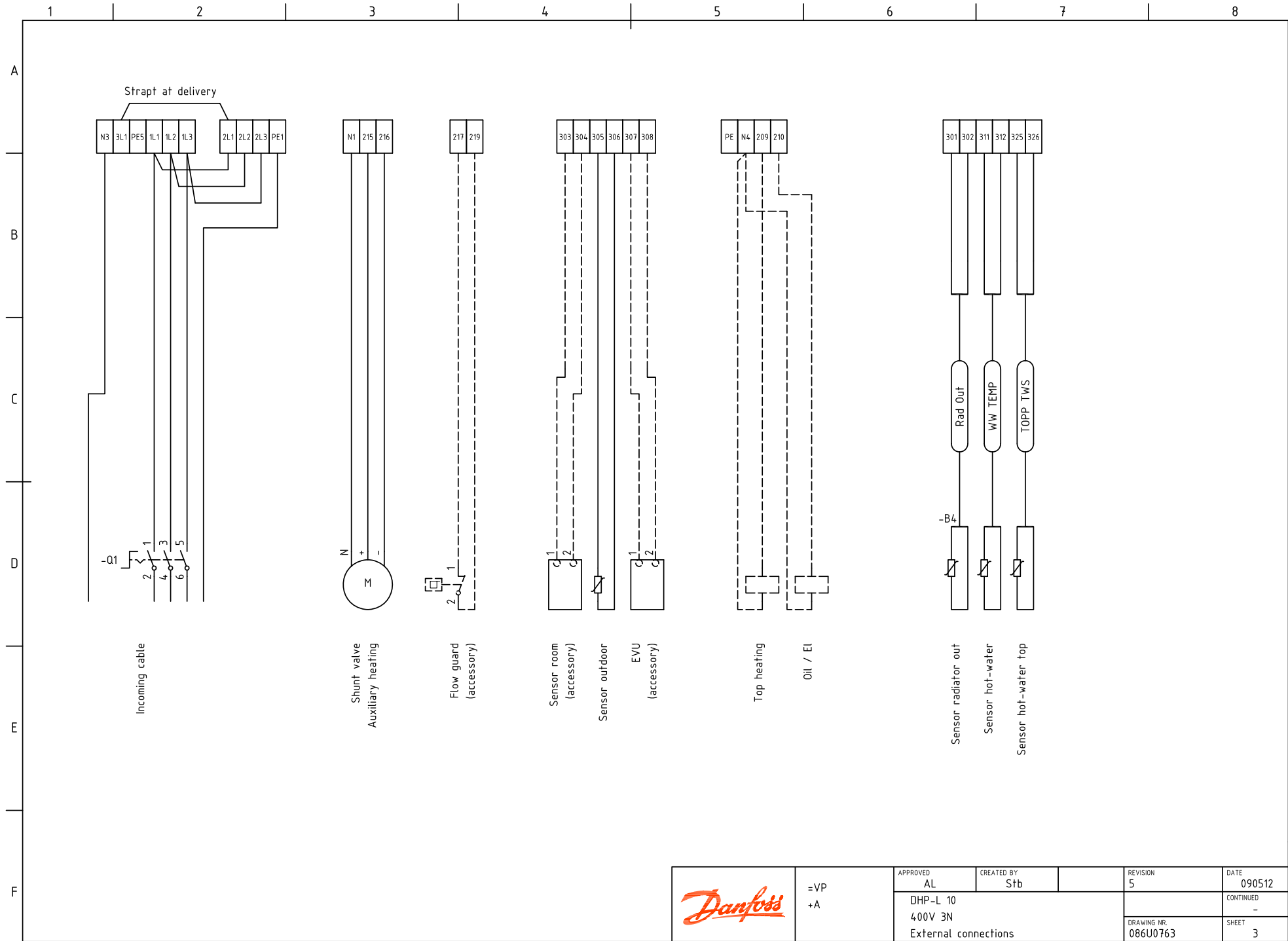

	=VP +A	APPROVED AL	CREATED BY Stb	REVISION 5	DATE 090512	
		DHP-L 10				CONTINUED -
		400V 3N				SHEET 3
External connections				DRAWING NR. 086U0763		

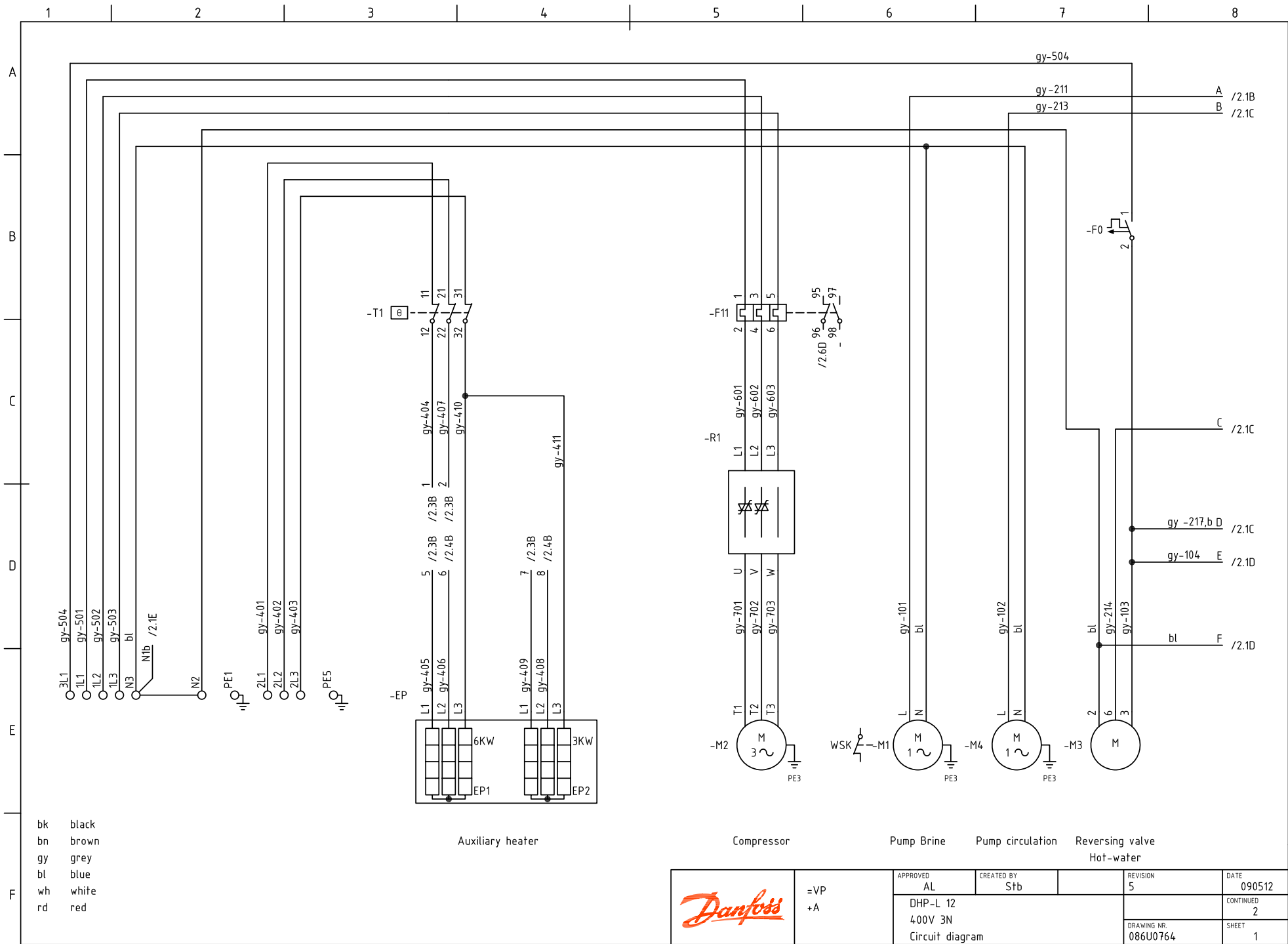

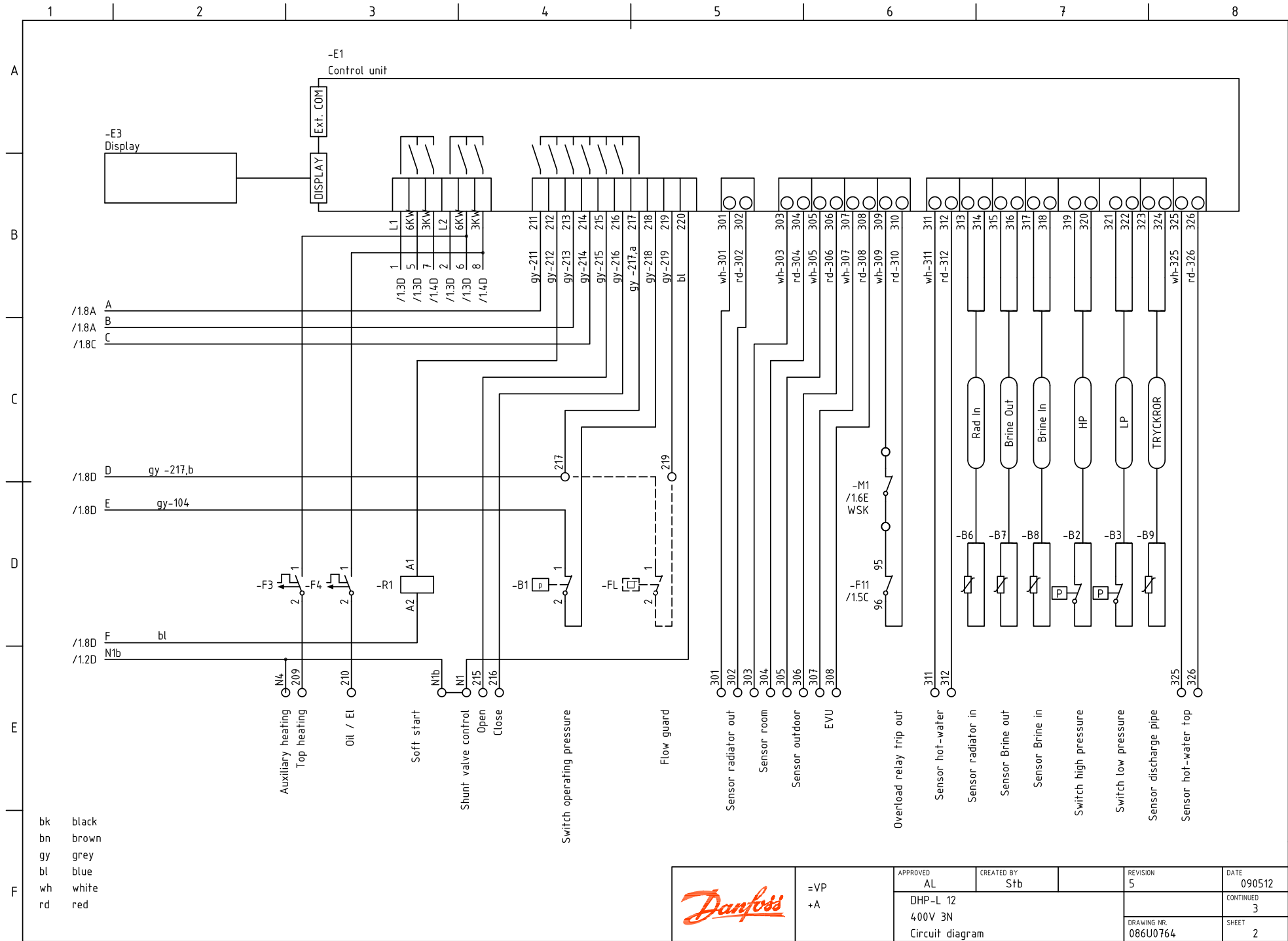

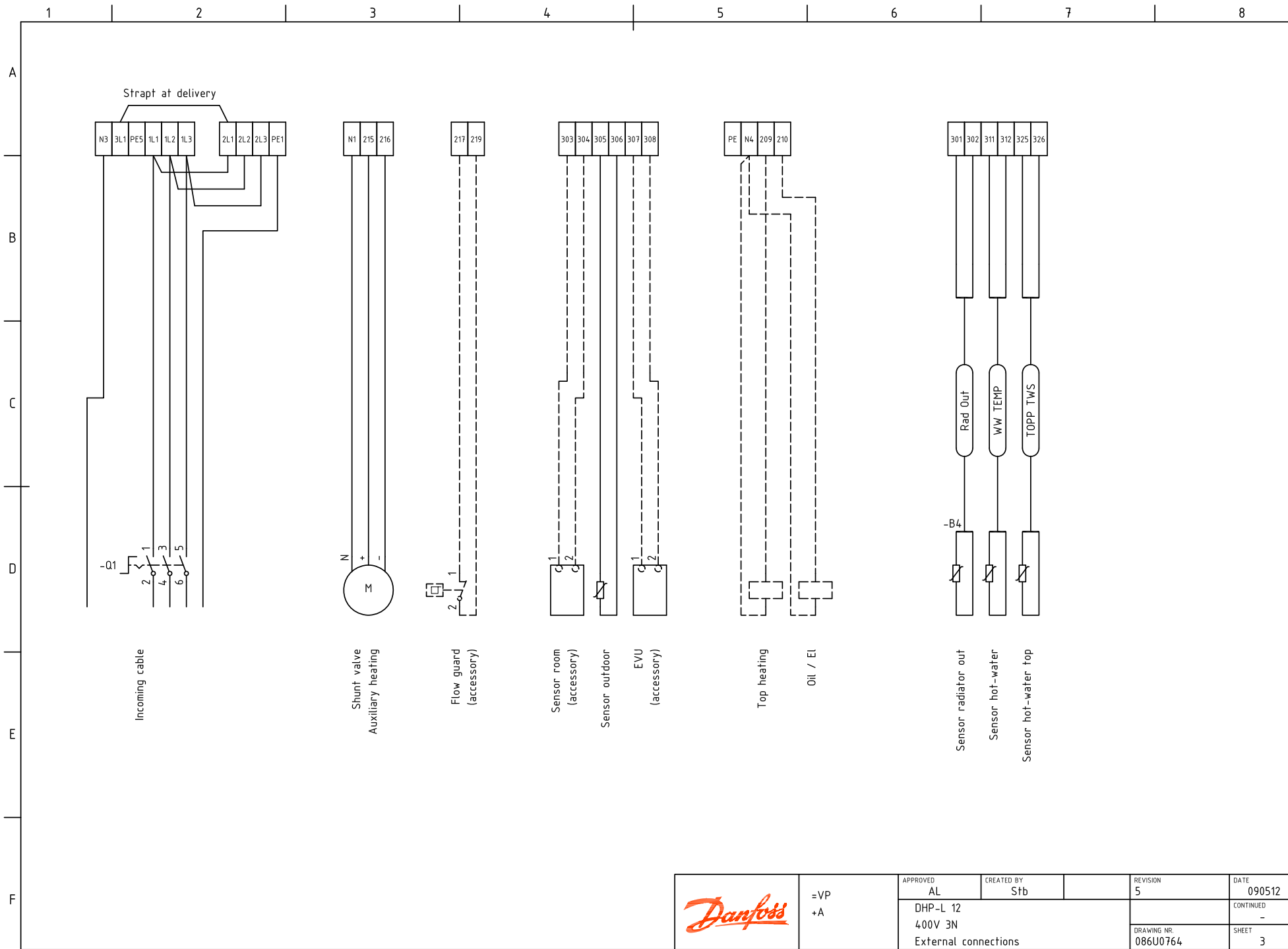

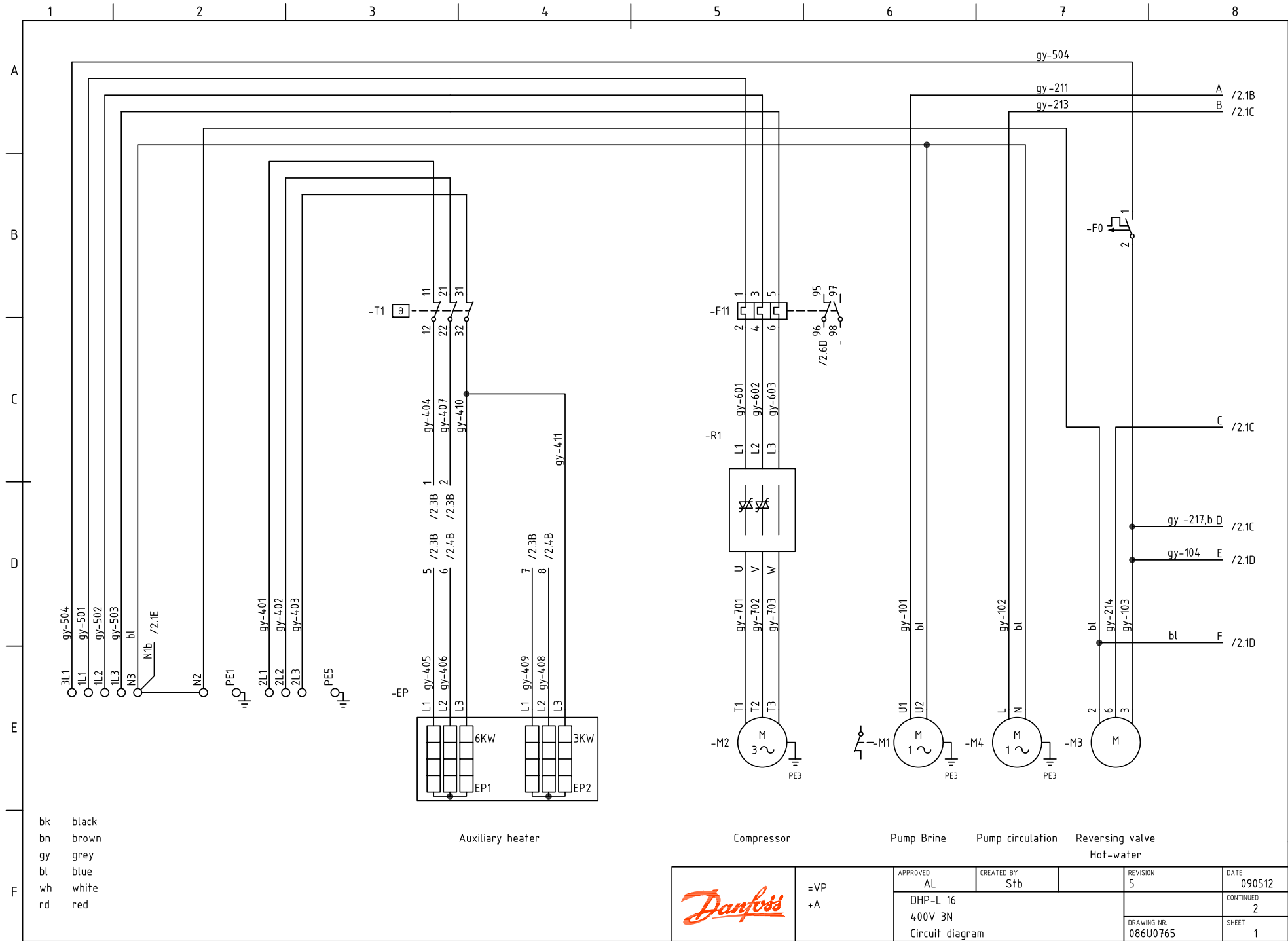

	=VP +A	APPROVED	CREATED BY	REVISION	DATE
		AL	Sfb	5	090512
		DHP-L 12 400V 3N External connections			
				DRAWING NR.	3
				086U0764	

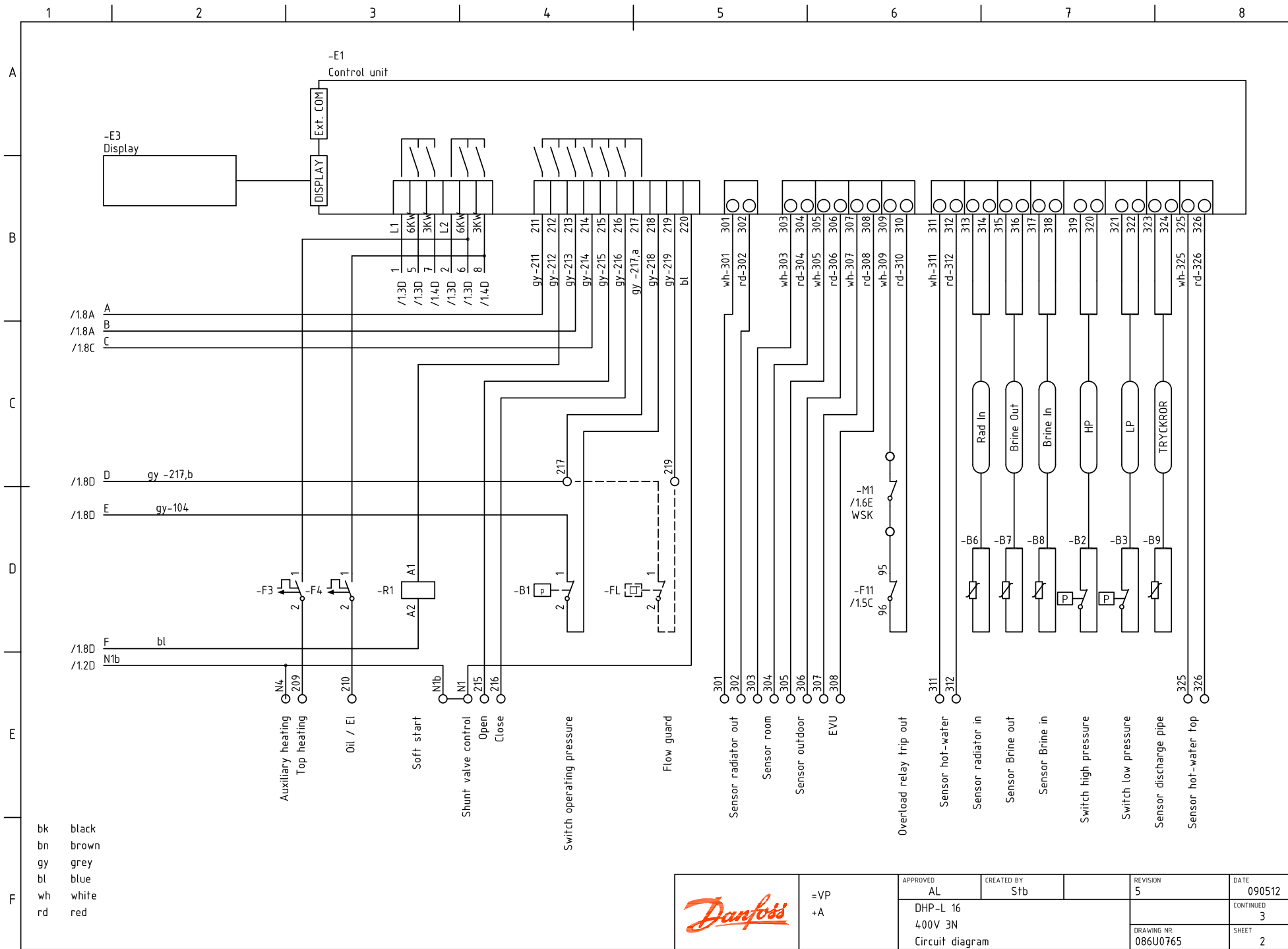

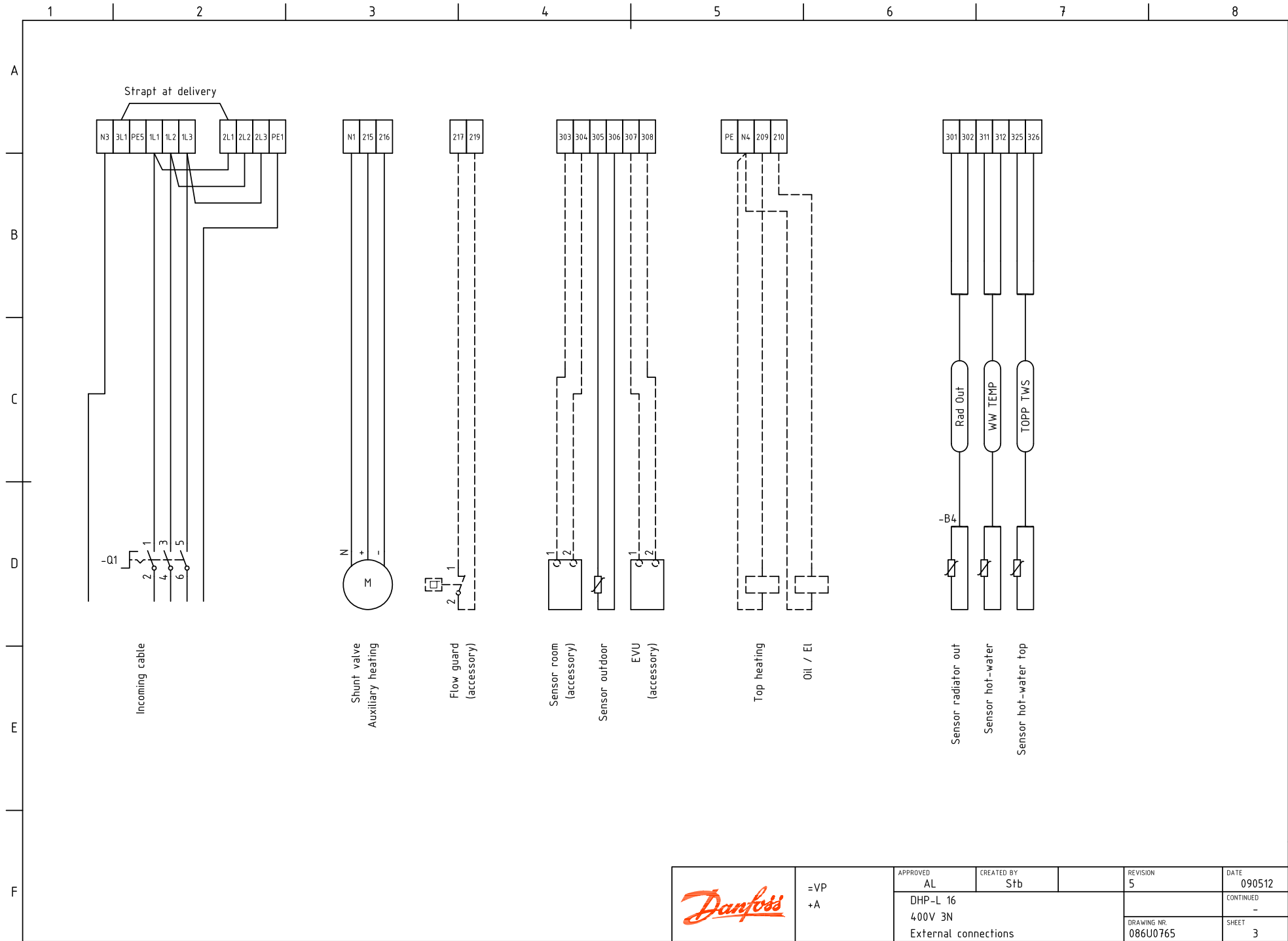

	=VP +A	APPROVED AL	CREATED BY Stb	REVISION 5	DATE 090512	
		DHP-L 16 400V 3N Circuit diagram			DRAWING NR. 086U0765	CONTINUED 3 SHEET 2



	=VP +A	APPROVED AL	CREATED BY Stb	REVISION 5	DATE 090512	
		DHP-L 16 400V 3N External connections				CONTINUED -
					DRAWING NR. 086U0765	SHEET 3

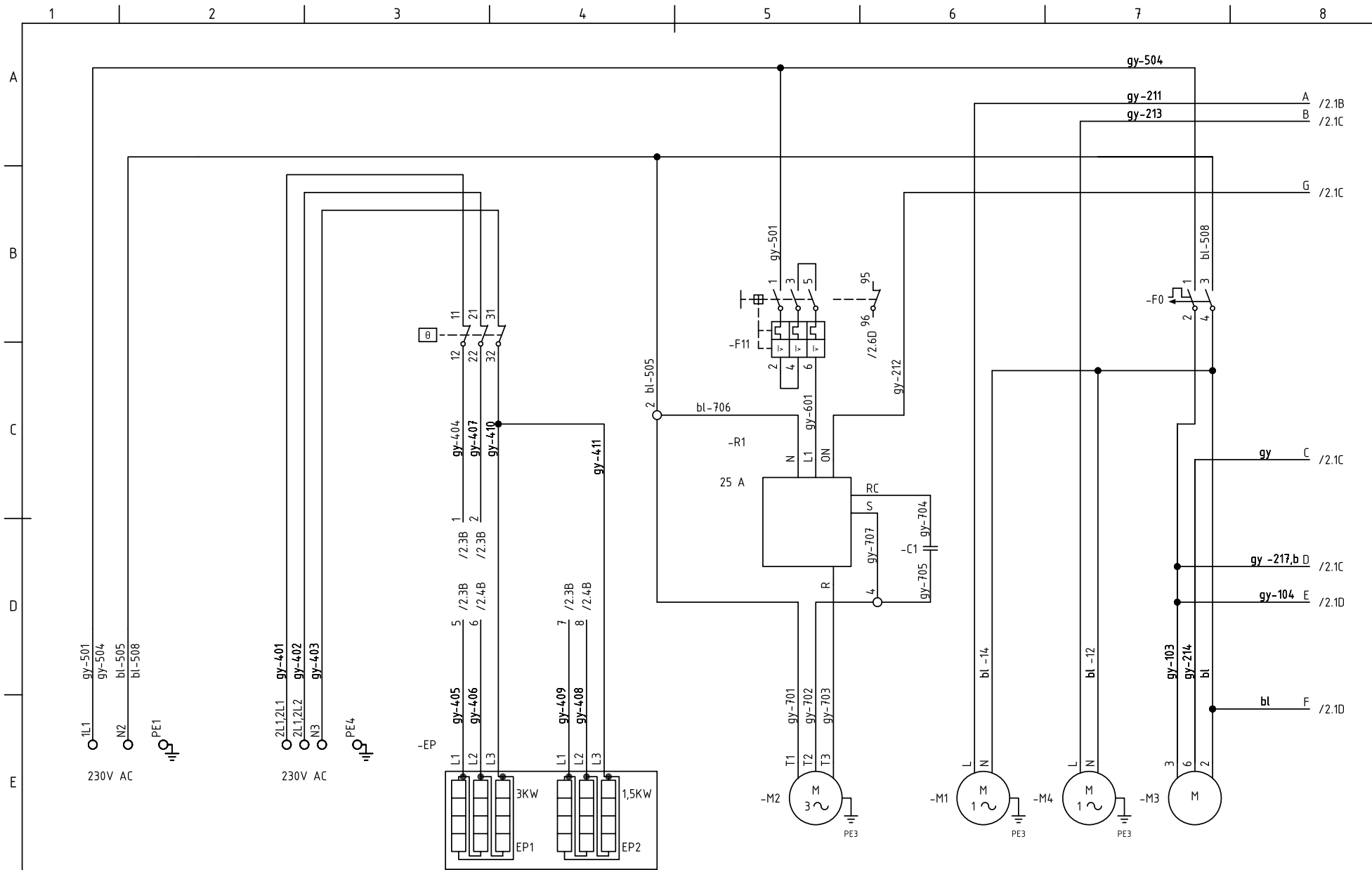

- bk black
- bn brown
- gy grey
- bl blue
- wh white
- rd red

Auxiliary heater

Compressor

Pump Brine

Pump circulation

Reversing valve
Hot-water

	=VP +A	APPROVED AL	CREATED BY Stb	REVISION 4	DATE 090512	
		DHP-L 4SP 230V 1N Circuit diagram			CONTINUED 2	SHEET 1
		DRAWING NR. 086U0771				

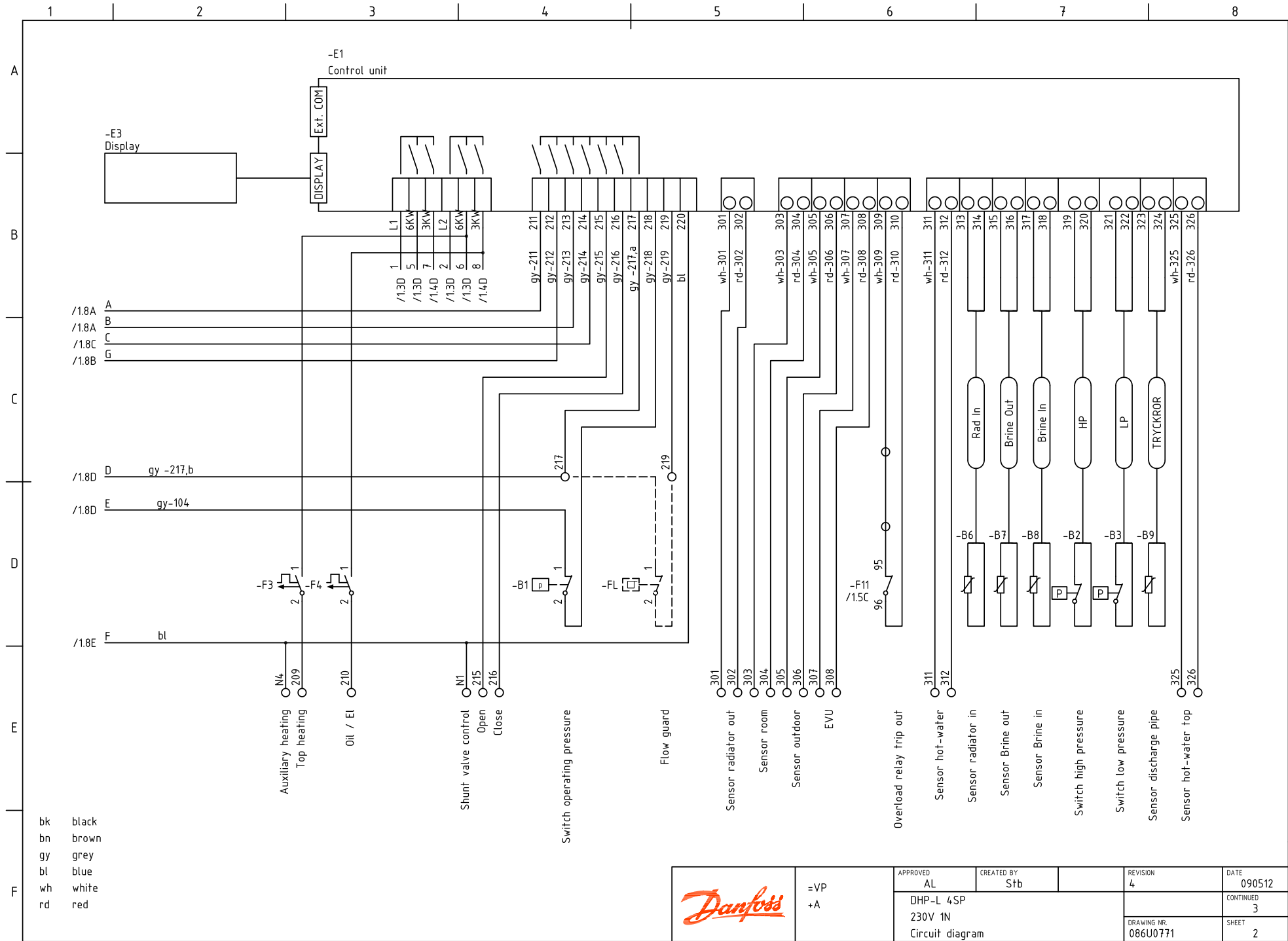

	=VP +A	APPROVED AL	CREATED BY Stb	REVISION 4	DATE 090512	
		DHP-L 4SP 230V 1N Circuit diagram			DRAWING NR. 086U0771	CONTINUED 3 SHEET 2

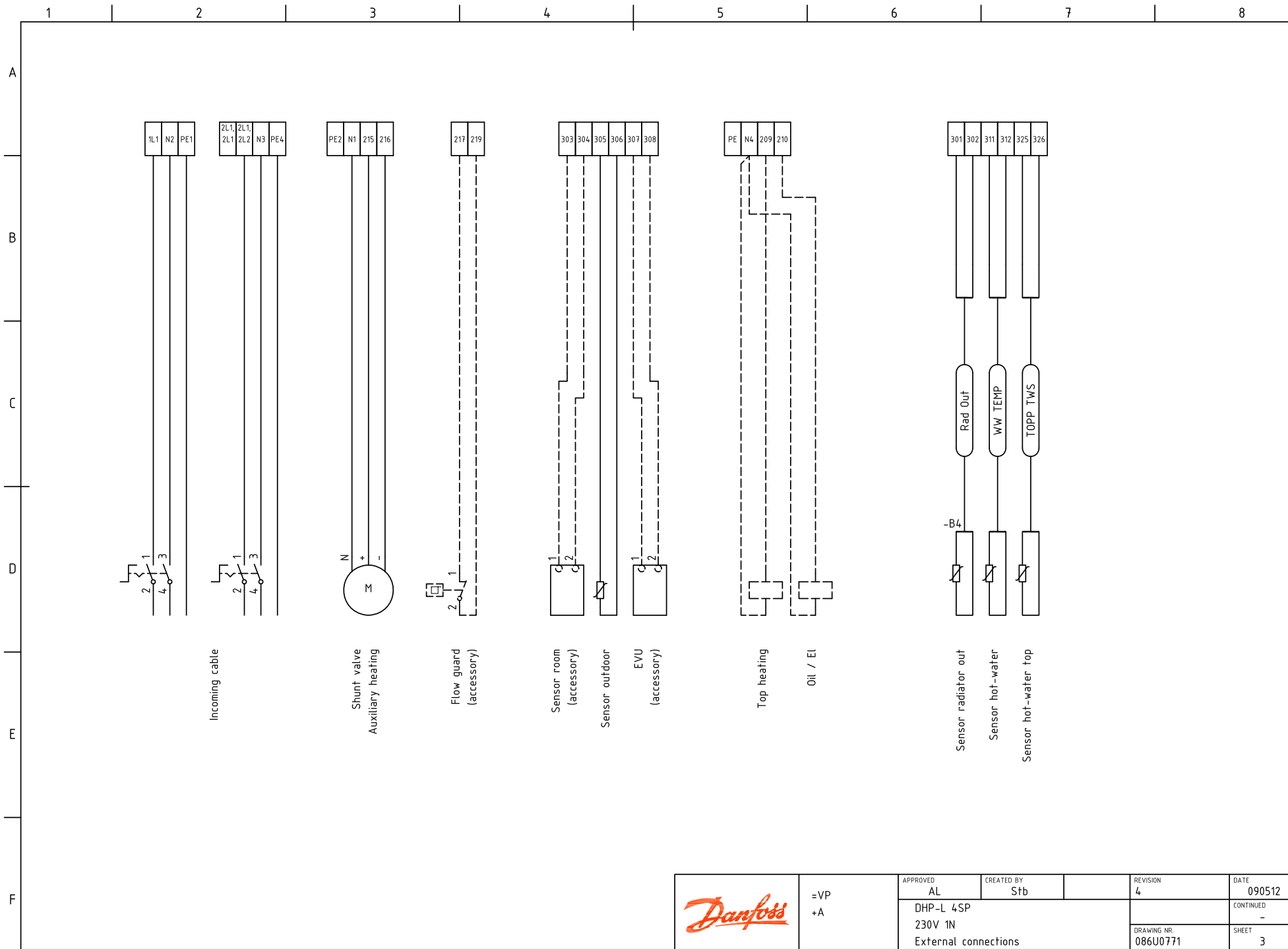

	=VP +A	APPROVED AL	CREATED BY Stb	REVISION 4	DATE 090512	
		DHP-L 4SP 230V 1N External connections				CONTINUED -
					DRAWING NR. 086U0771	SHEET 3

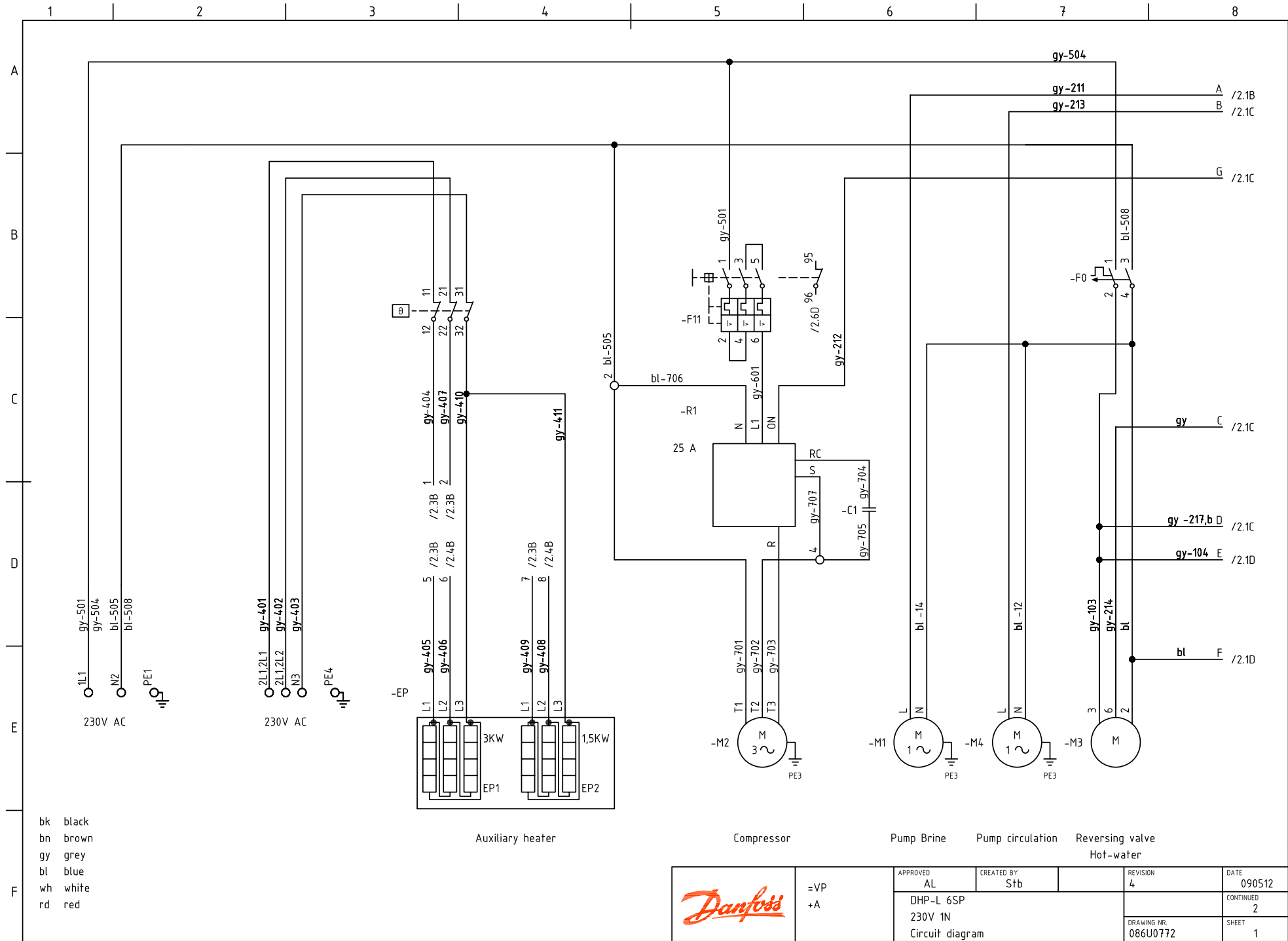

bk black
 bn brown
 gy grey
 bl blue
 wh white
 rd red

Auxiliary heater

Compressor

Pump Brine

Pump circulation

Reversing valve
 Hot-water

	=VP +A	APPROVED AL	CREATED BY Stb	REVISION 4	DATE 090512	
		DHP-L 6SP 230V 1N Circuit diagram			CONTINUED 2	SHEET 1
		DRAWING NR. 086U0772				

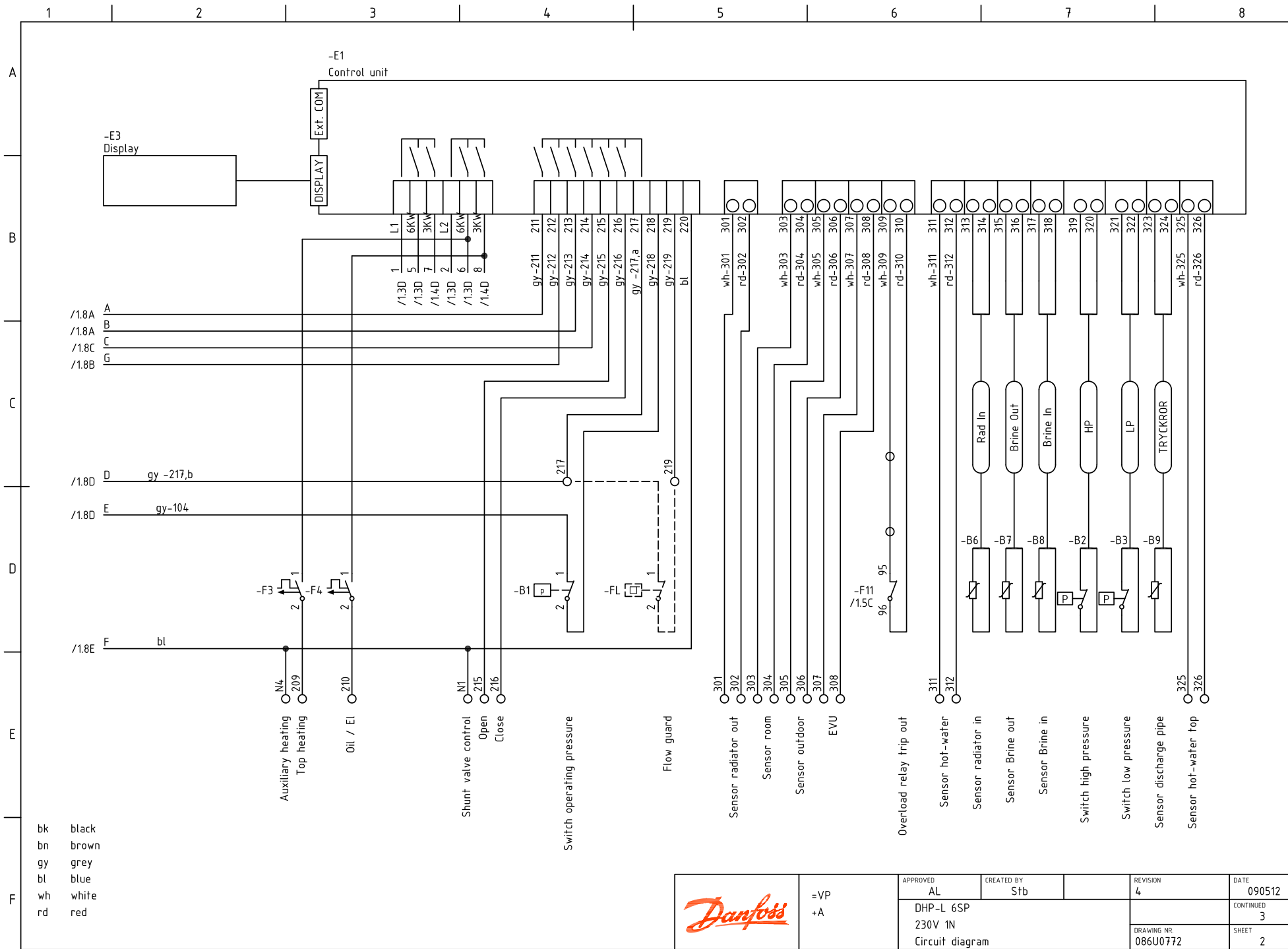

	=VP +A	APPROVED AL	CREATED BY Stb	REVISION 4	DATE 090512	
		DHP-L 6SP 230V 1N Circuit diagram			CONTINUED 3	SHEET 2
					DRAWING NR. 086U0772	

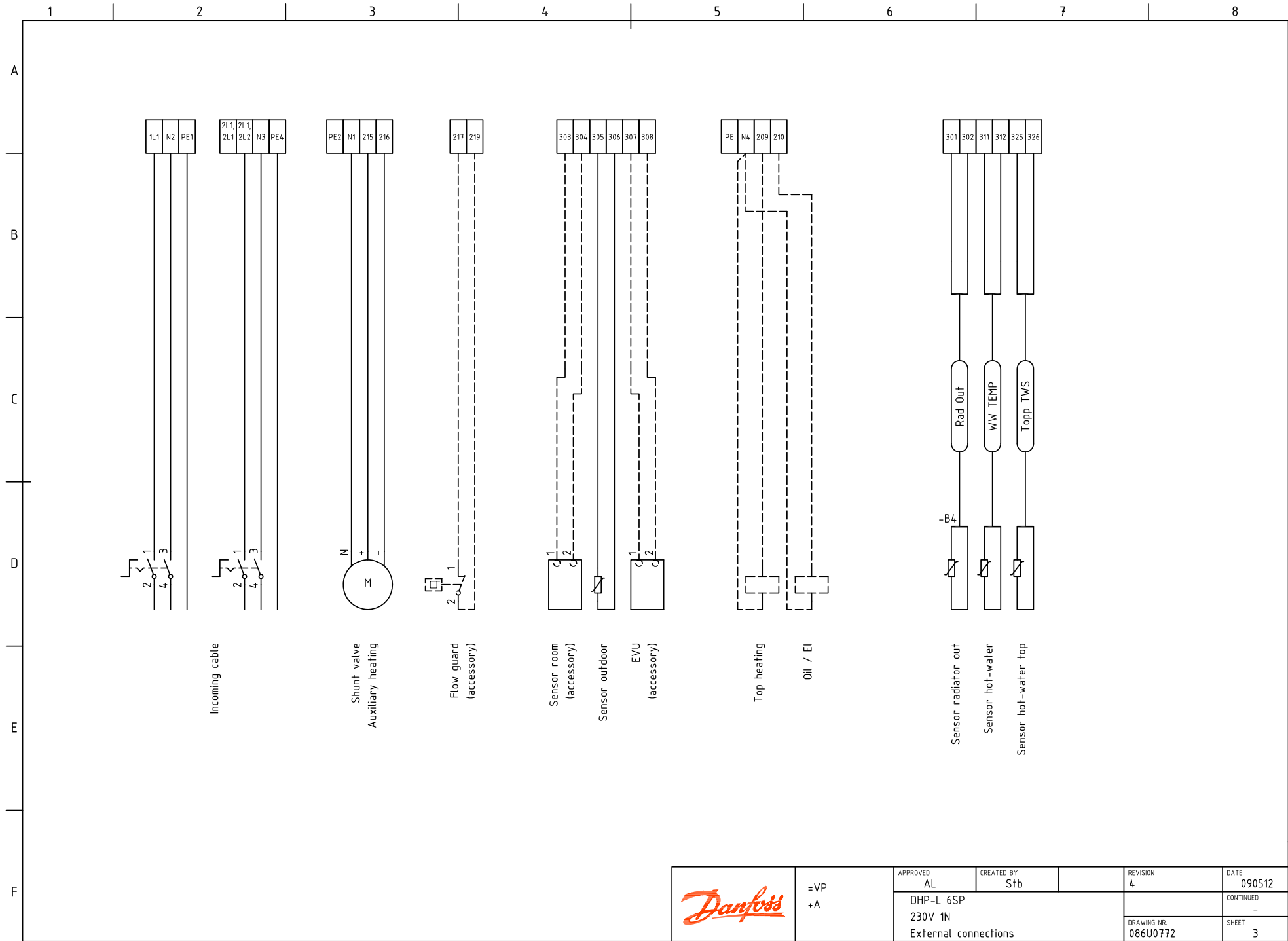

	=VP +A	APPROVED AL	CREATED BY Stb	REVISION 4	DATE 090512	
		DHP-L 6SP 230V 1N External connections				CONTINUED -
					DRAWING NR. 086U0772	SHEET 3

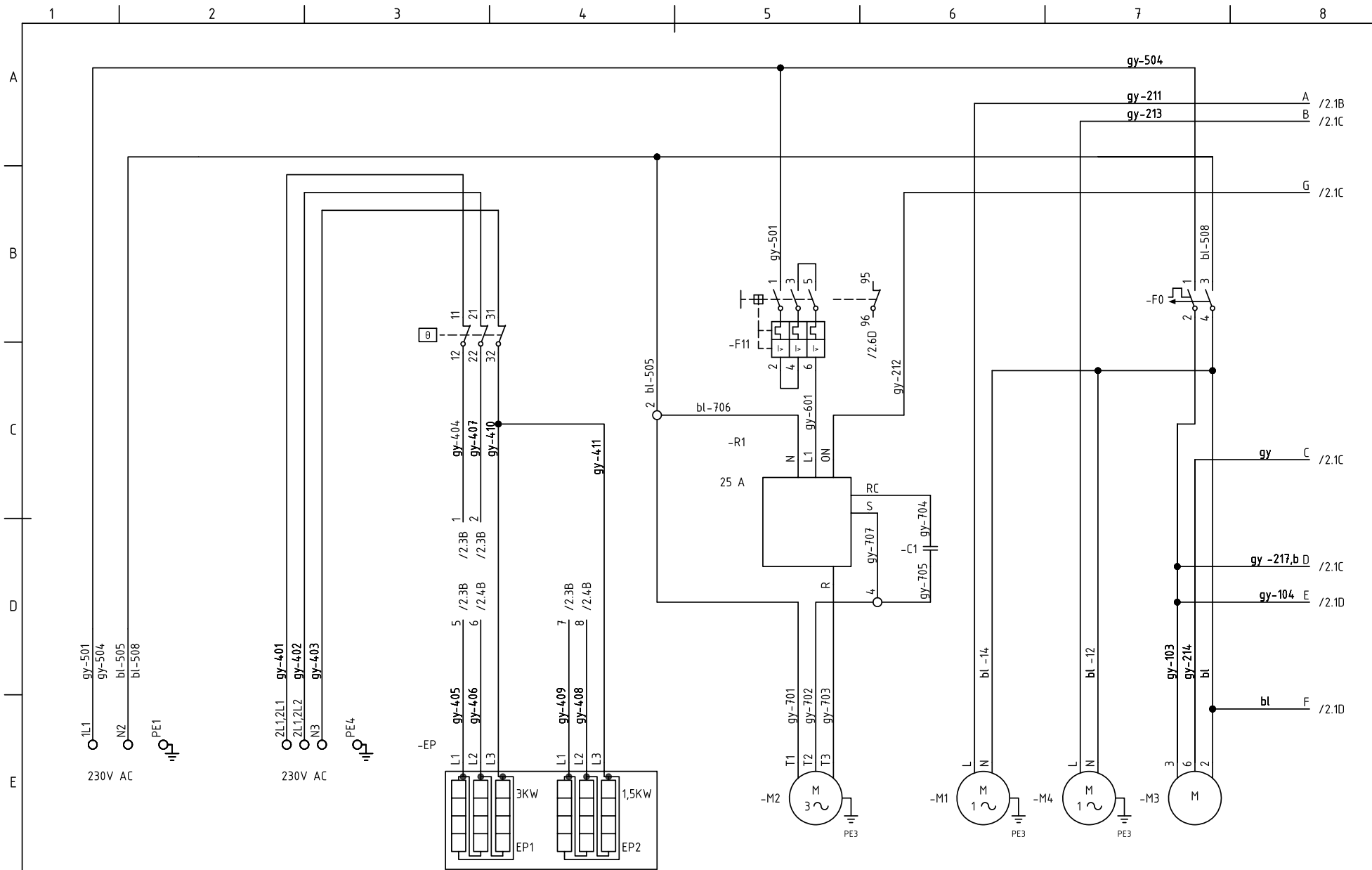

- bk black
- bn brown
- gy grey
- bl blue
- wh white
- rd red

Auxiliary heater

Compressor

Pump Brine

Pump circulation

Reversing valve
Hot-water

	=VP	APPROVED AL	CREATED BY Stb	REVISION 4	DATE 090512
	+A	DHP-L 8SP 230V 1N Circuit diagram			CONTINUED 2
					DRAWING NR. 086U0773

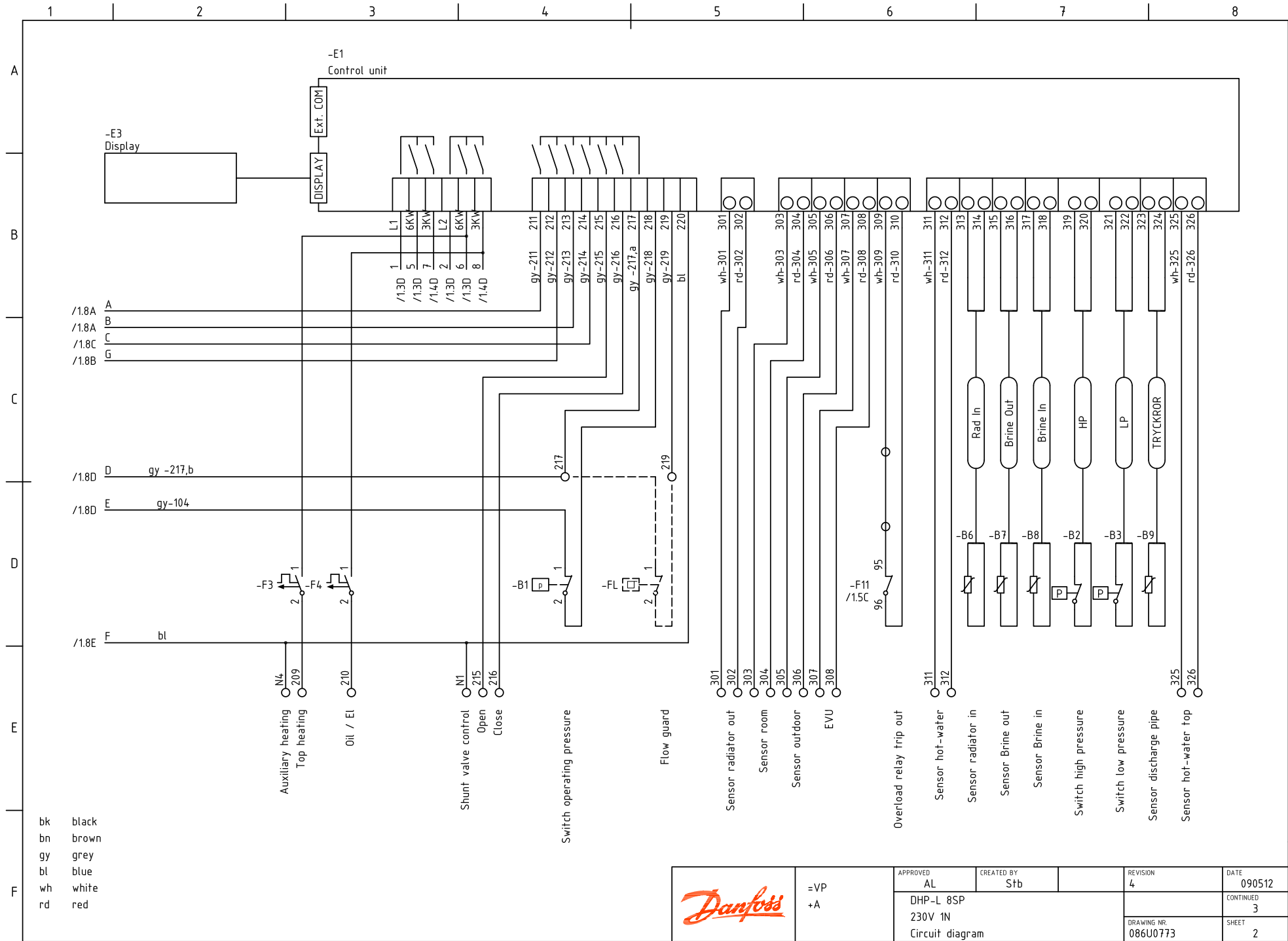

	=VP +A	APPROVED AL	CREATED BY Stb	REVISION 4	DATE 090512	
		DHP-L 8SP 230V 1N Circuit diagram			CONTINUED 3	SHEET 2
					DRAWING NR. 086U0773	

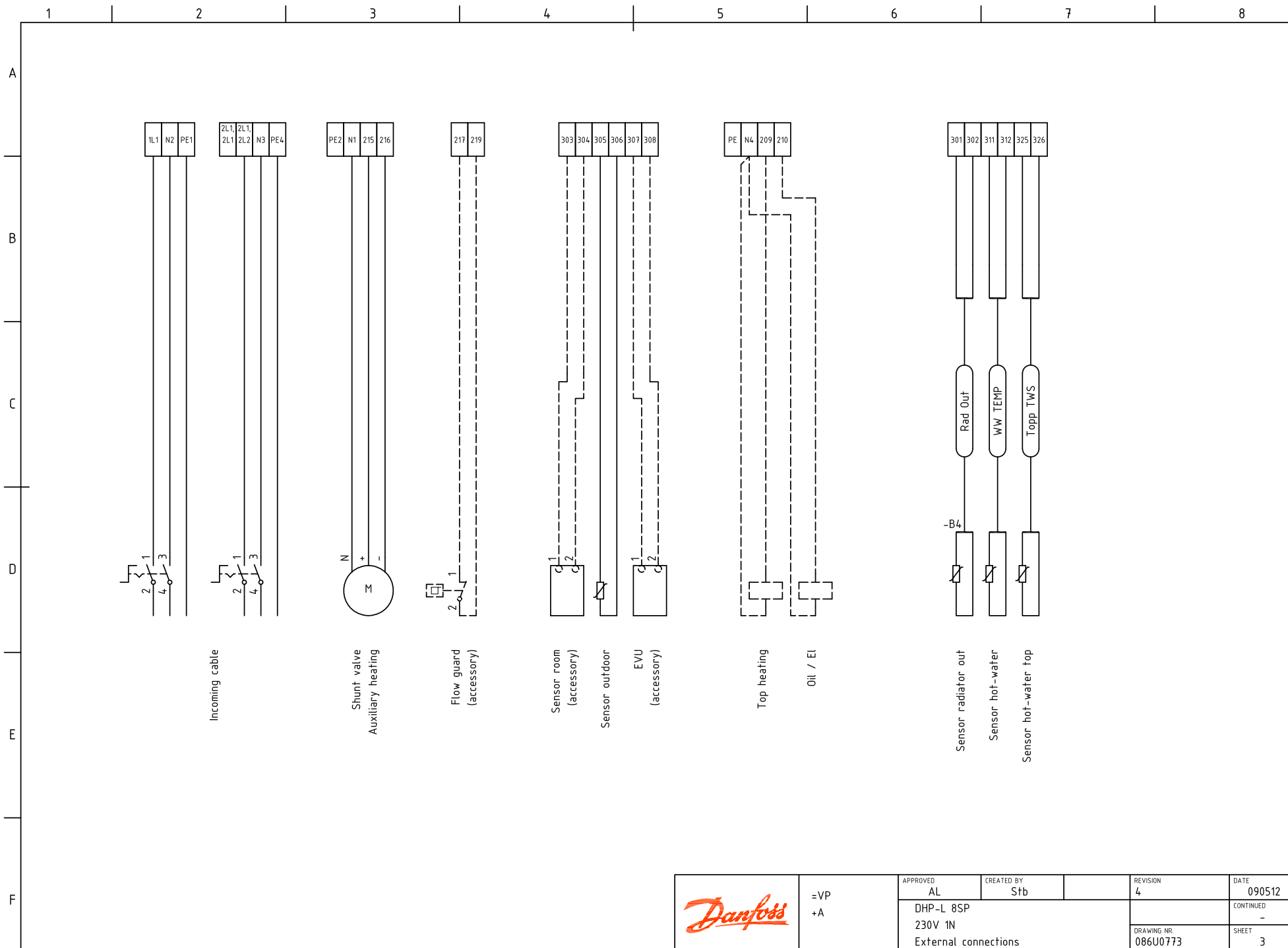

	=VP +A	APPROVED AL	CREATED BY Stb	REVISION 4	DATE 090512	
		DHP-L 8SP 230V 1N External connections				CONTINUED -
					DRAWING NR. 086U0773	SHEET 3

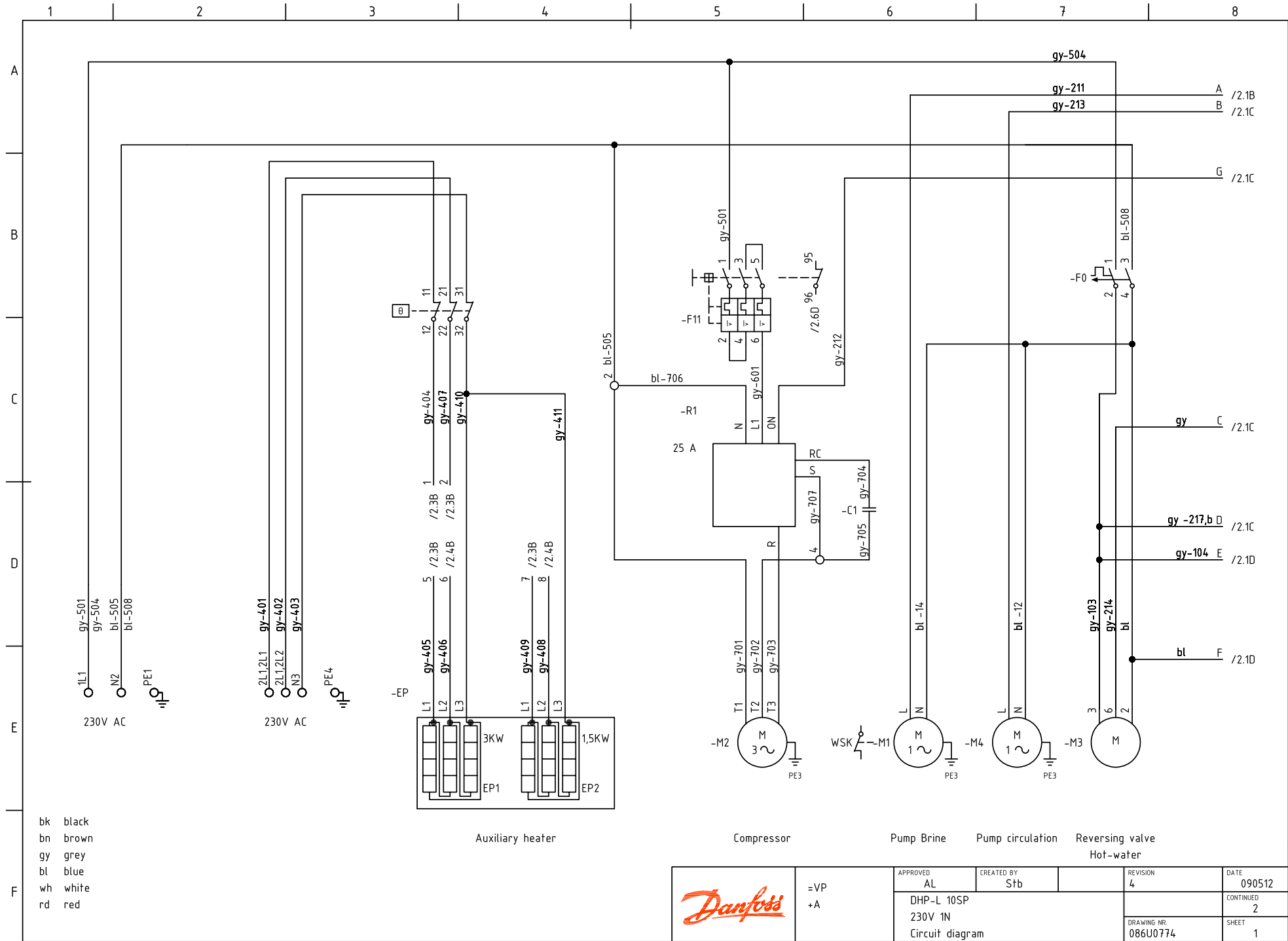

bk black
 bn brown
 gy grey
 bl blue
 wh white
 rd red

Auxiliary heater

Compressor

Pump Brine

Pump circulation

Reversing valve
 Hot-water

	=VP +A	APPROVED AL	CREATED BY Stb	REVISION 4	DATE 090512	
		DHP-L 10SP 230V 1N Circuit diagram				CONTINUED 2
					DRAWING NR. 086U0774	SHEET 1

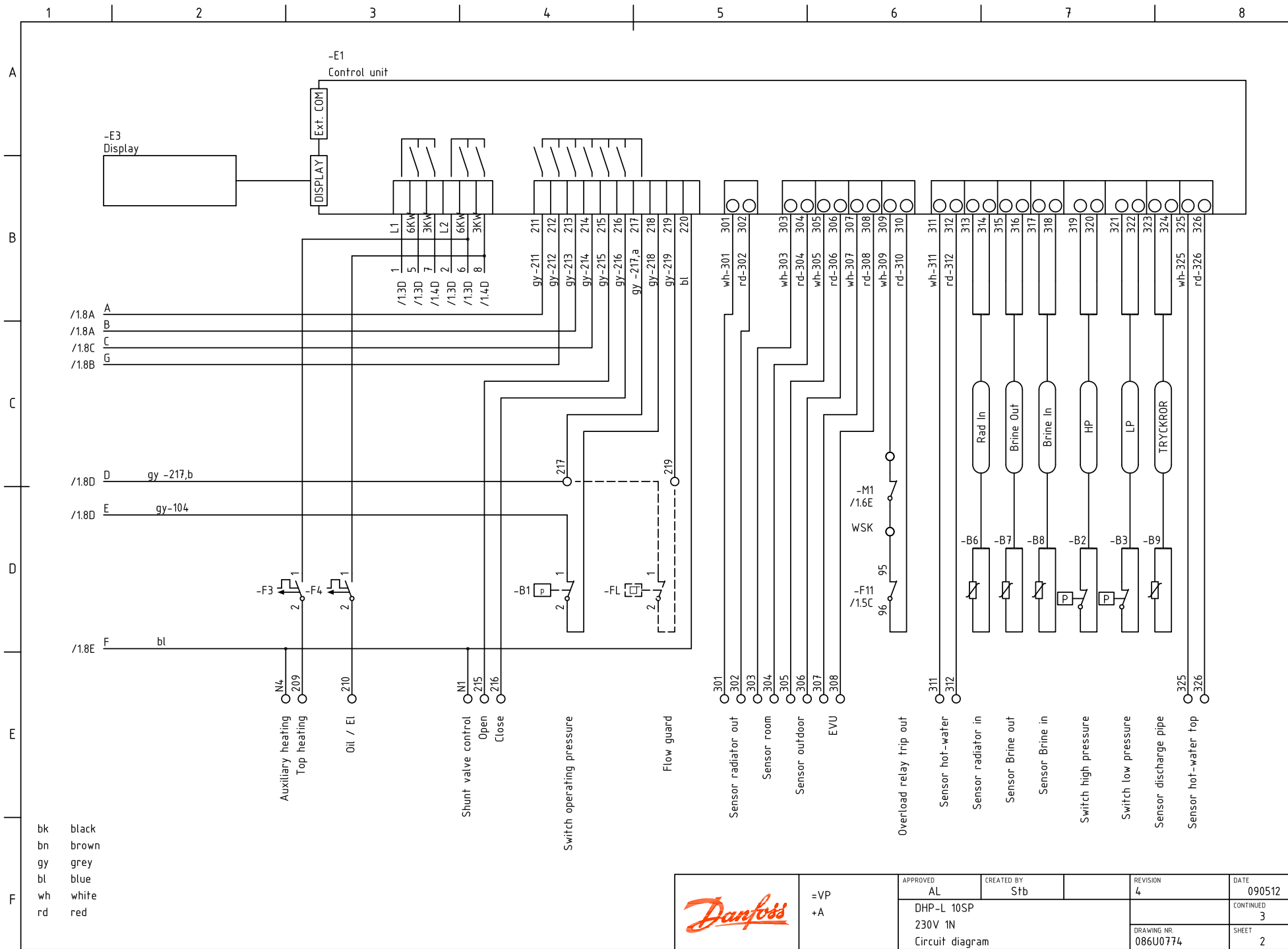

	=VP +A	APPROVED AL	CREATED BY Stb	REVISION 4	DATE 090512	
		DHP-L 10SP 230V 1N Circuit diagram			DRAWING NR. 086U0774	CONTINUED 3 SHEET 2

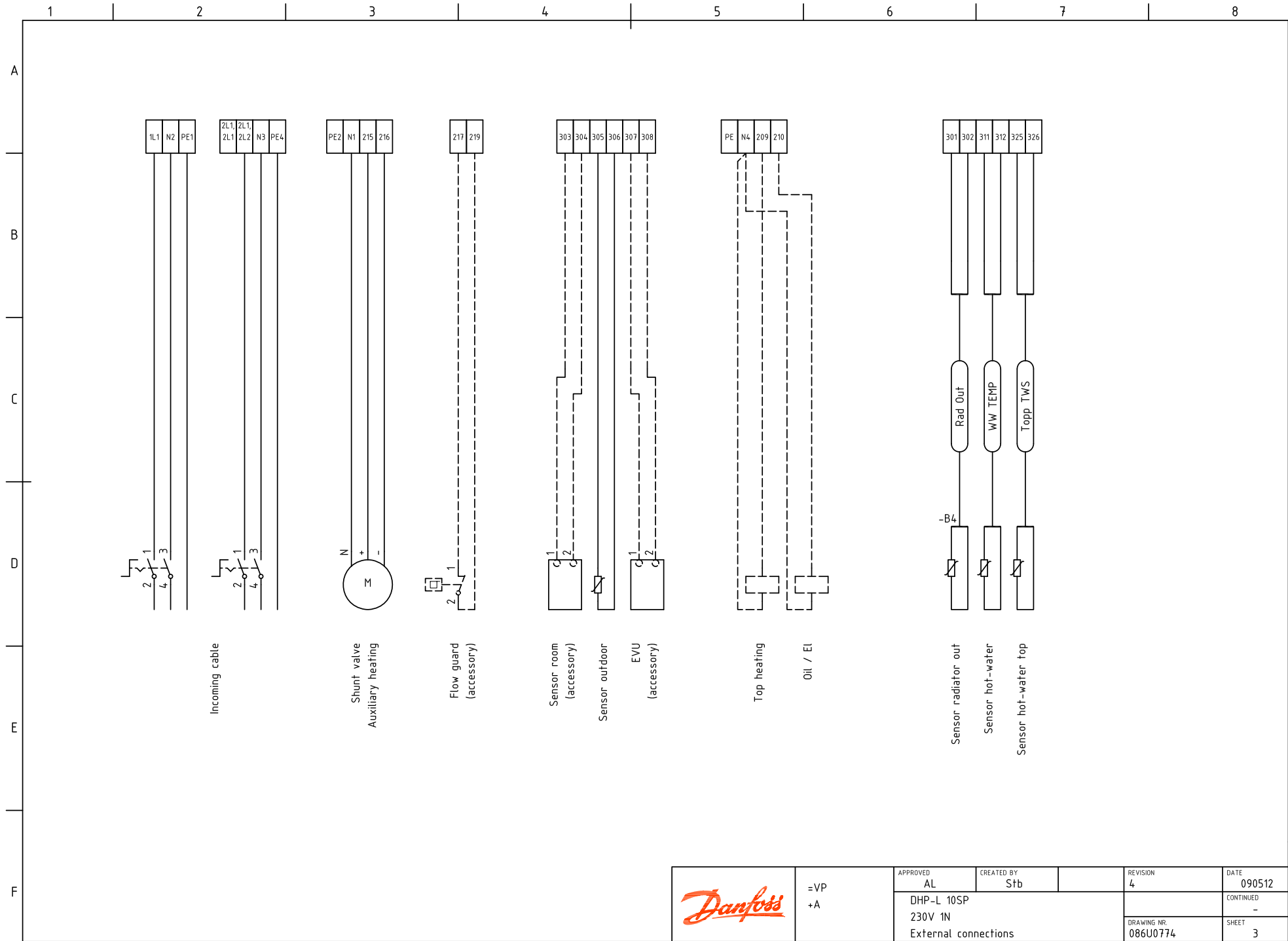

	=VP +A	APPROVED AL	CREATED BY Stb	REVISION 4	DATE 090512	
		DHP-L 10SP 230V 1N External connections				CONTINUED -
					DRAWING NR. 086U0774	SHEET 3

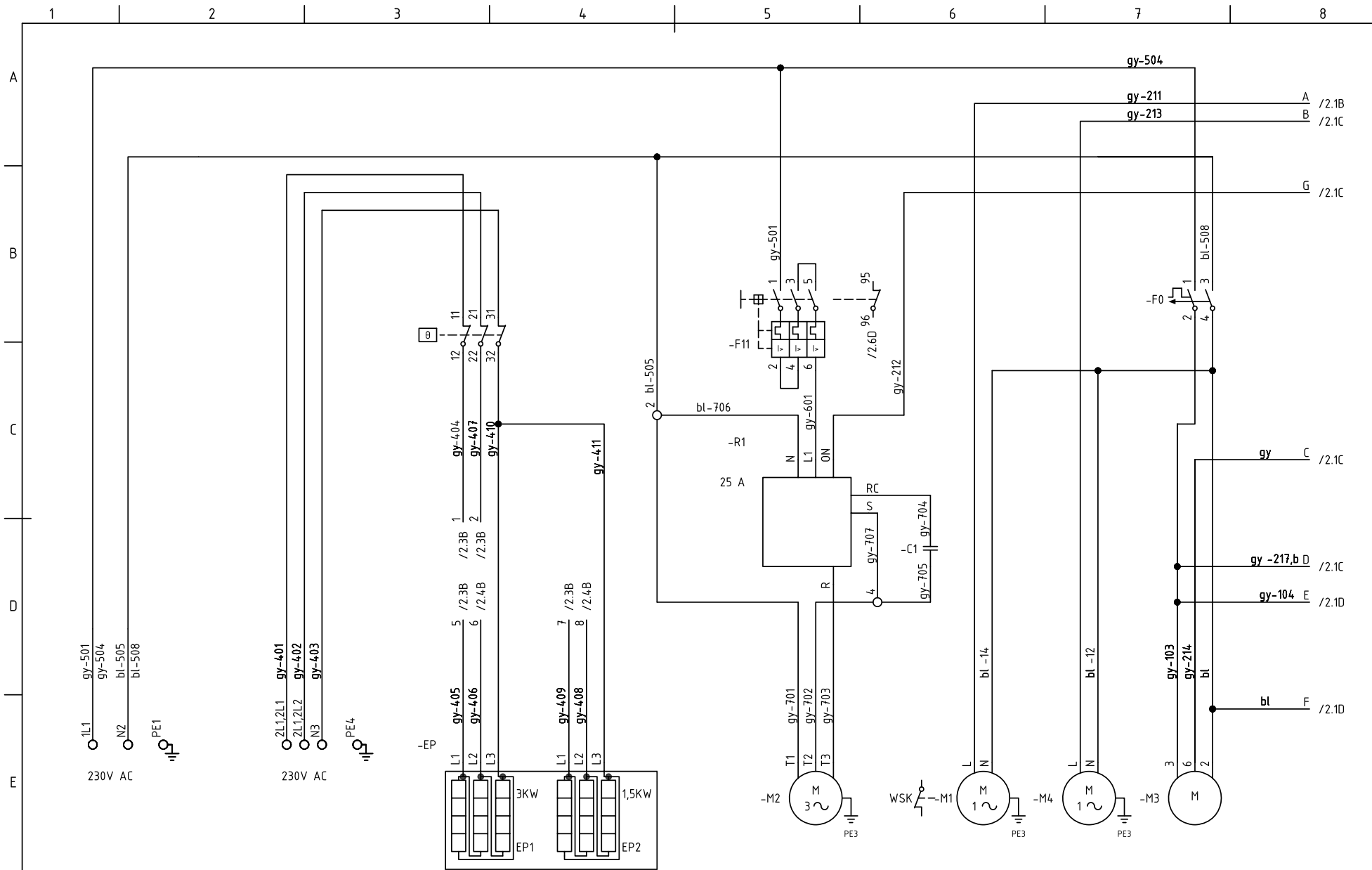

- bk black
- bn brown
- gy grey
- bl blue
- wh white
- rd red

Auxiliary heater

Compressor

Pump Brine

Pump circulation

Reversing valve
Hot-water

	=VP +A	APPROVED AL	CREATED BY Stb	REVISION 4	DATE 090512	
		DHP-L 12SP 230V 1N Circuit diagram			DRAWING NR. 086U0775	CONTINUED 2 SHEET 1

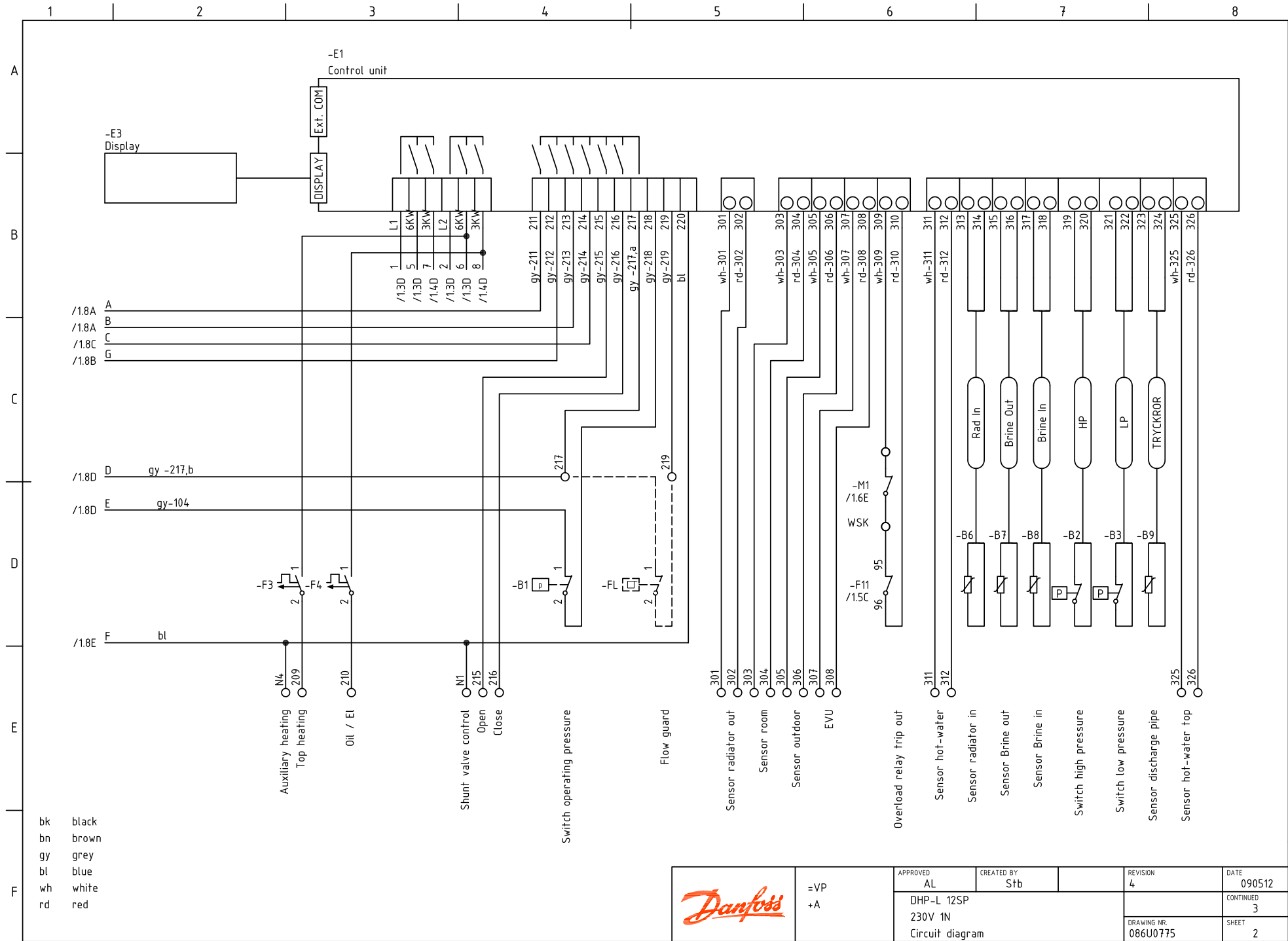

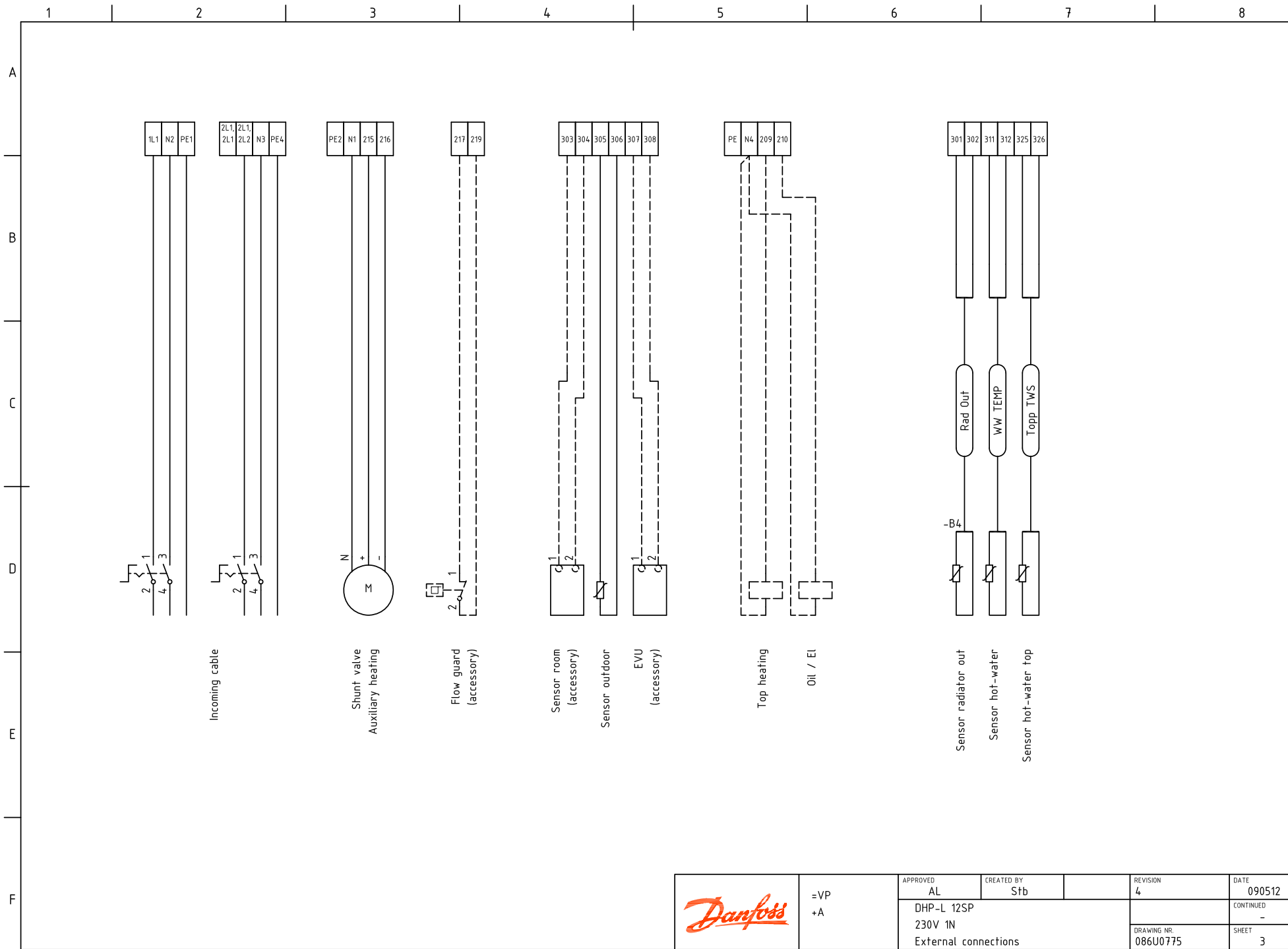

	=VP +A	APPROVED AL	CREATED BY Stb	REVISION 4	DATE 090512	
		DHP-L 12SP				CONTINUED -
		230V 1N				SHEET 3
External connections				DRAWING NR. 086U0775		

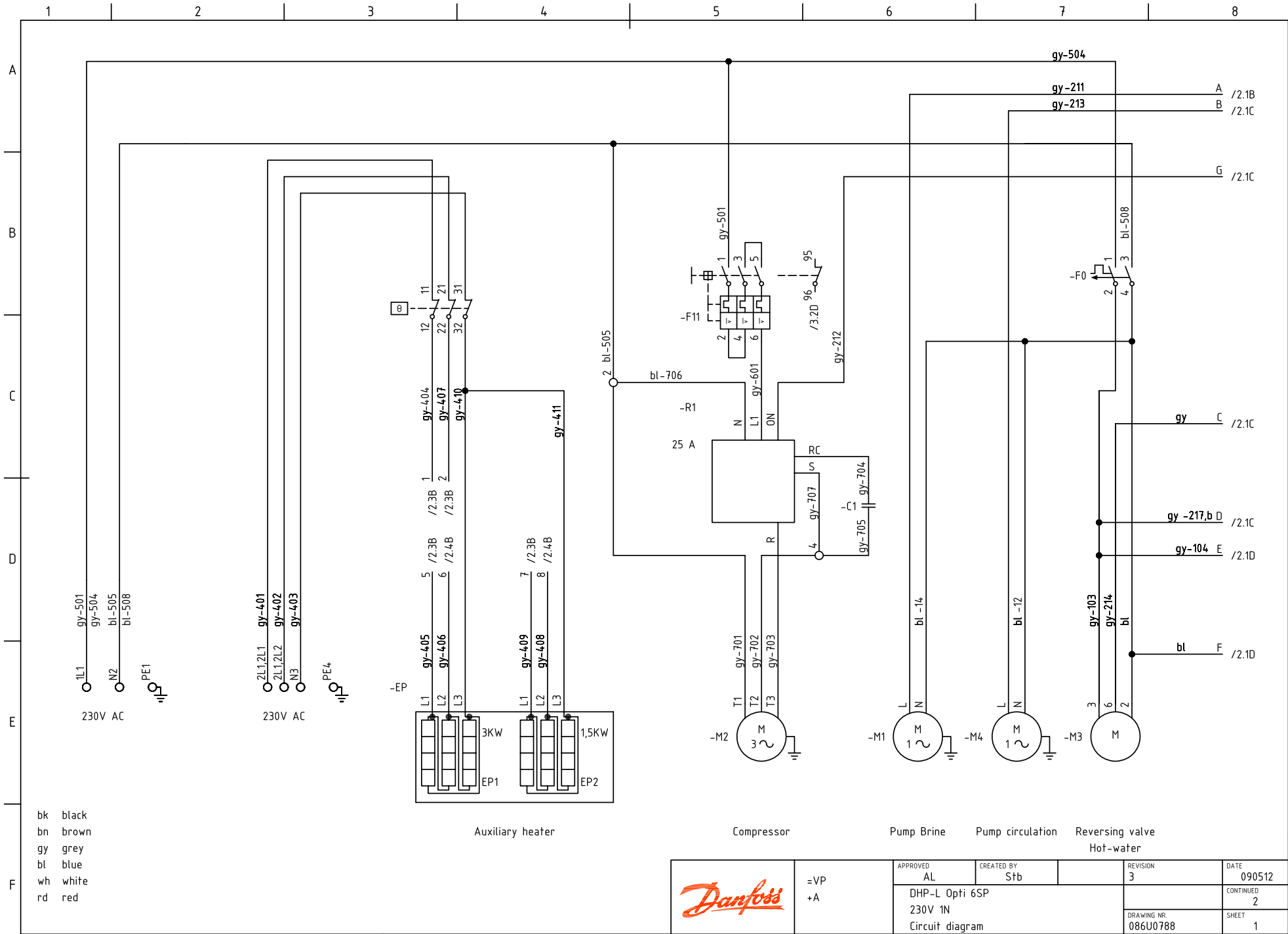

- bk black
- bn brown
- gy grey
- bl blue
- wh white
- rd red

Auxiliary heater

Compressor

Pump Brine

Pump circulation

Reversing valve
Hot-water

	=VP +A	APPROVED AL	CREATED BY Stb	REVISION 3	DATE 090512	
		DHP-L Opti 6SP 230V 1N Circuit diagram			CONTINUED 2	SHEET 1
					DRAWING NR. 086U0788	

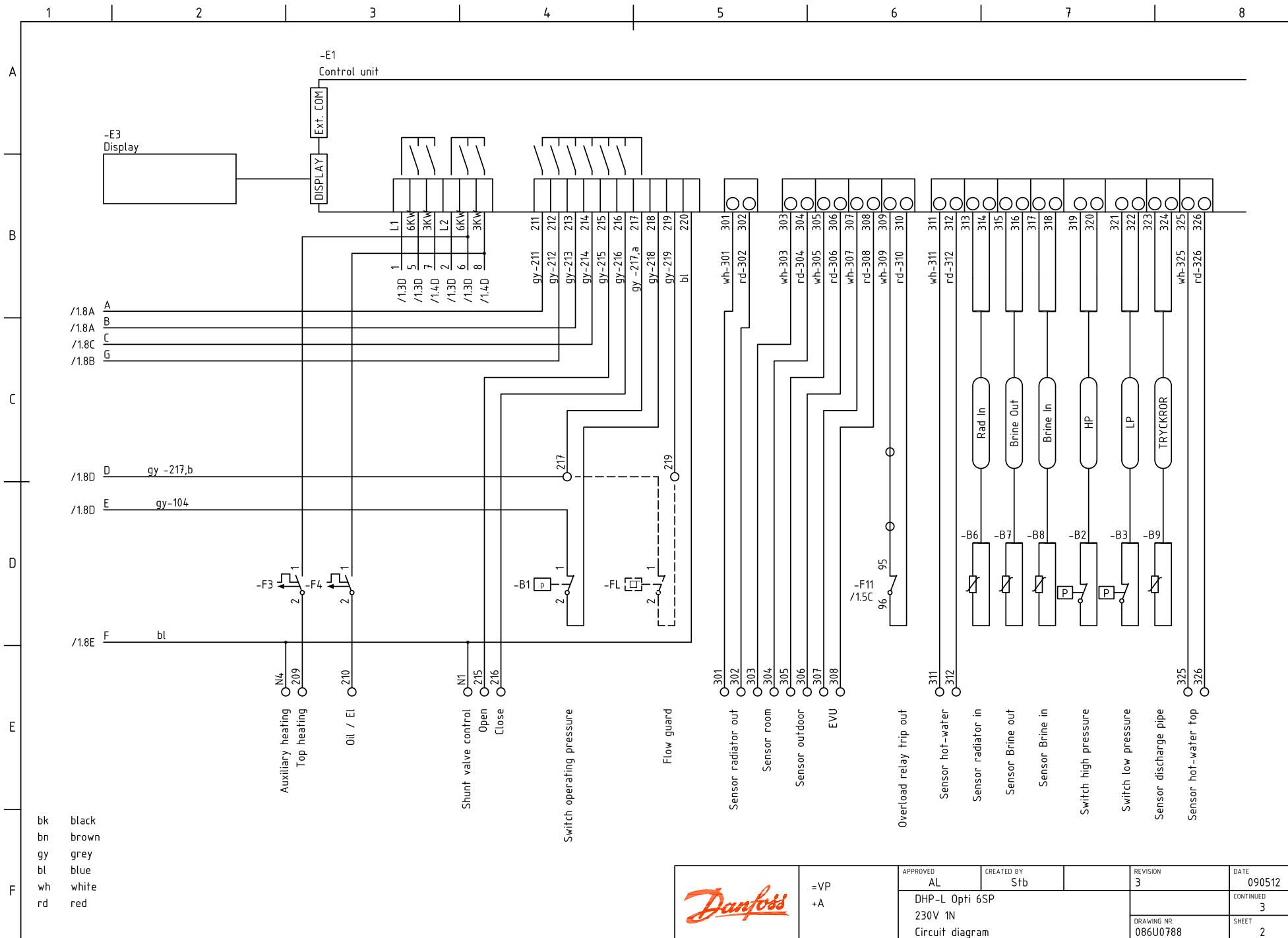

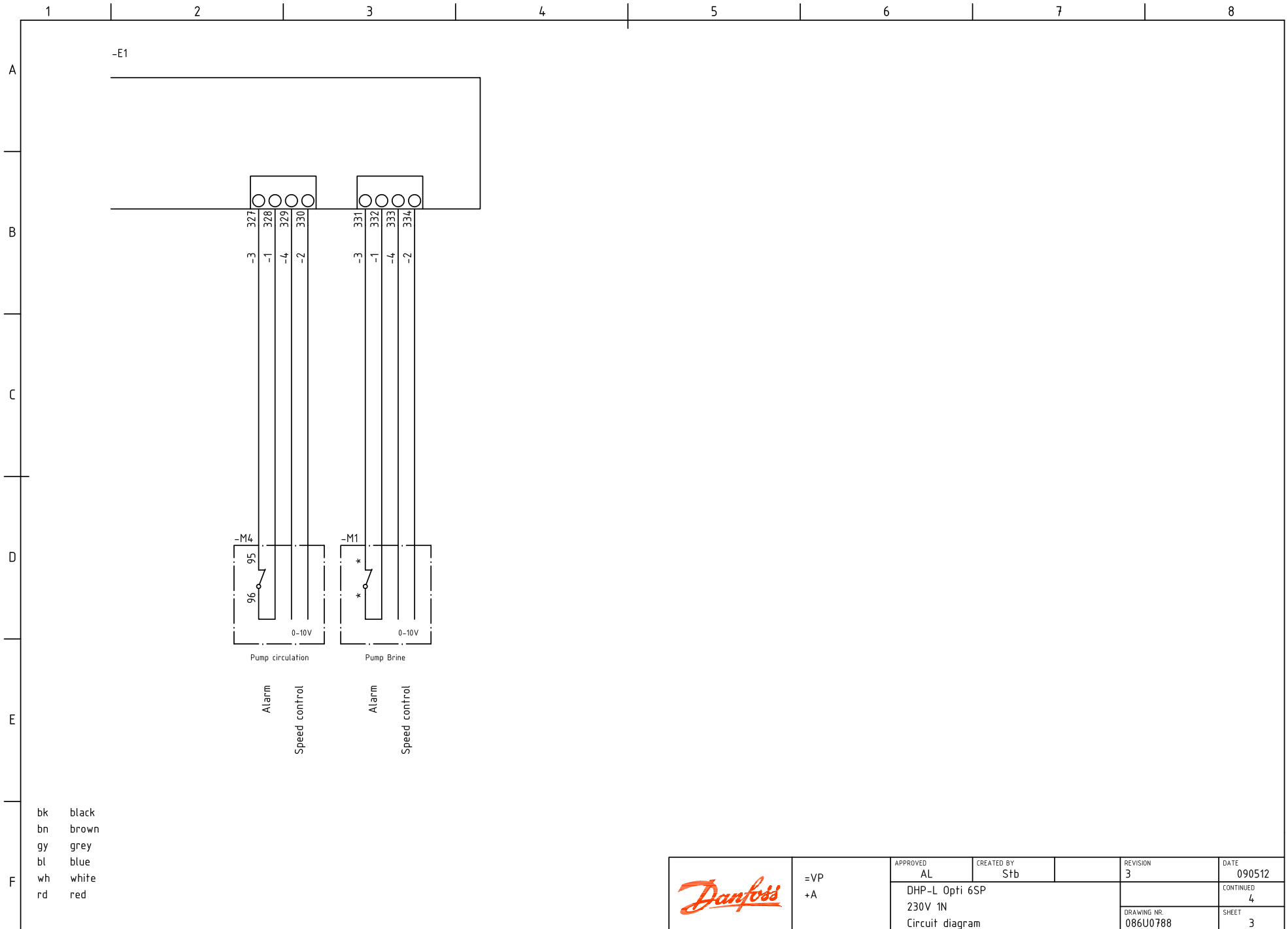

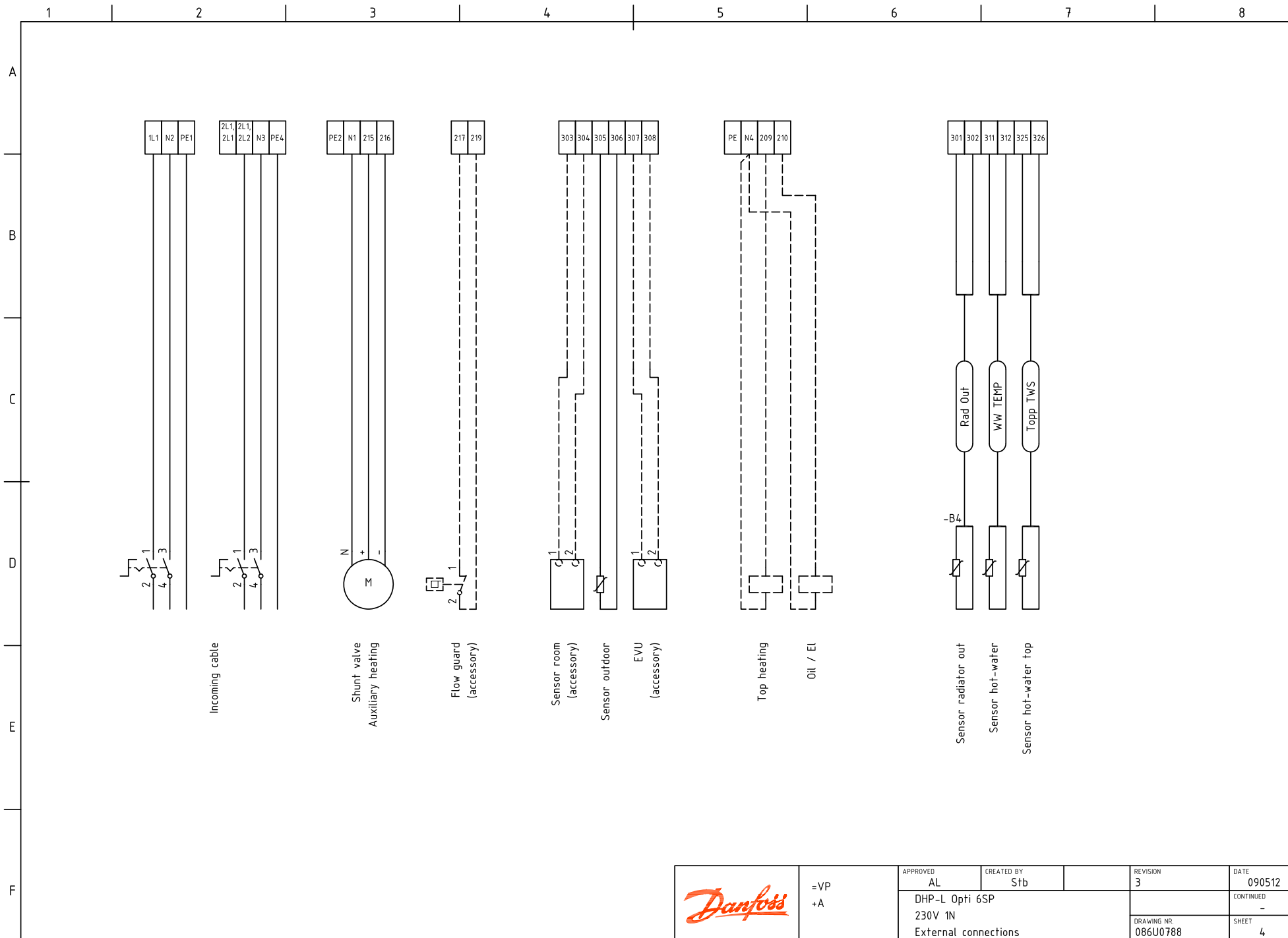

	=VP +A	APPROVED	CREATED BY	REVISION	DATE
		AL	Stb	3	090512
		DHP-L Opti 6SP 230V 1N External connections			
				DRAWING NR.	SHEET
				086U0788	4

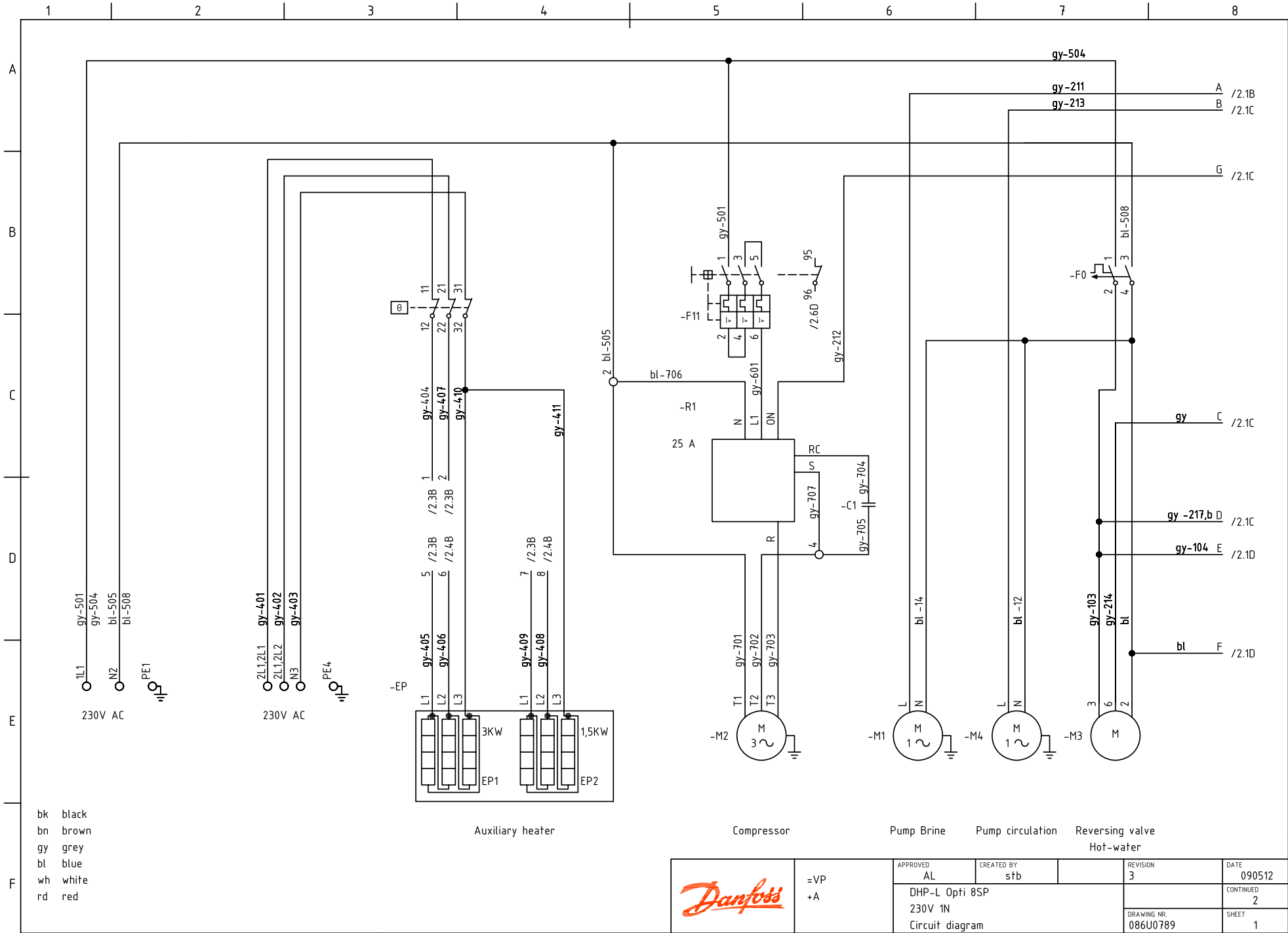

bk black
 bn brown
 gy grey
 bl blue
 wh white
 rd red

Auxiliary heater

Compressor

Pump Brine

Pump circulation

Reversing valve
 Hot-water

	=VP +A	APPROVED AL	CREATED BY stb	REVISION 3	DATE 090512	
		DHP-L Opti 8SP 230V 1N Circuit diagram			DRAWING NR. 086U0789	CONTINUED 2
					SHEET 1	

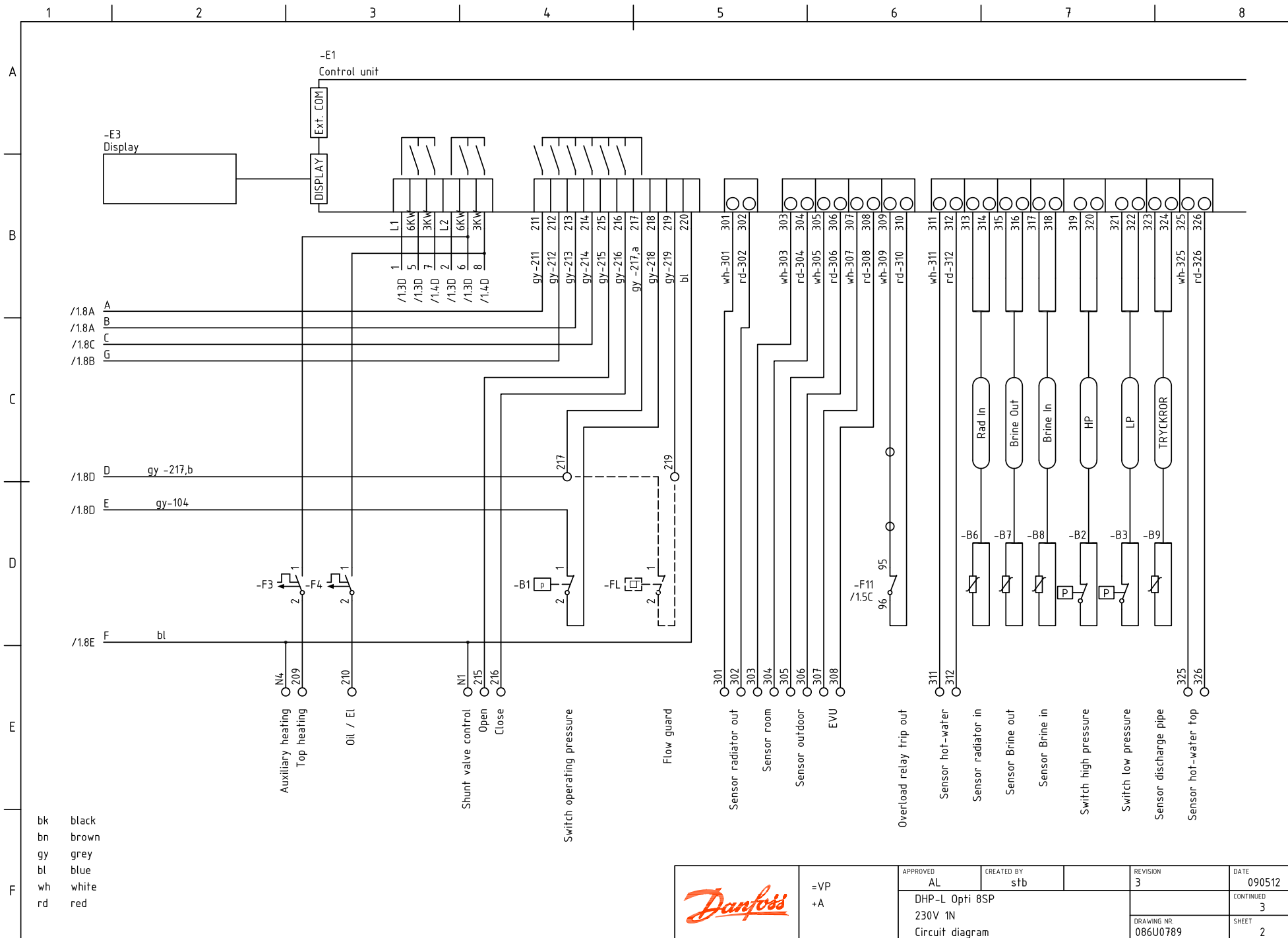

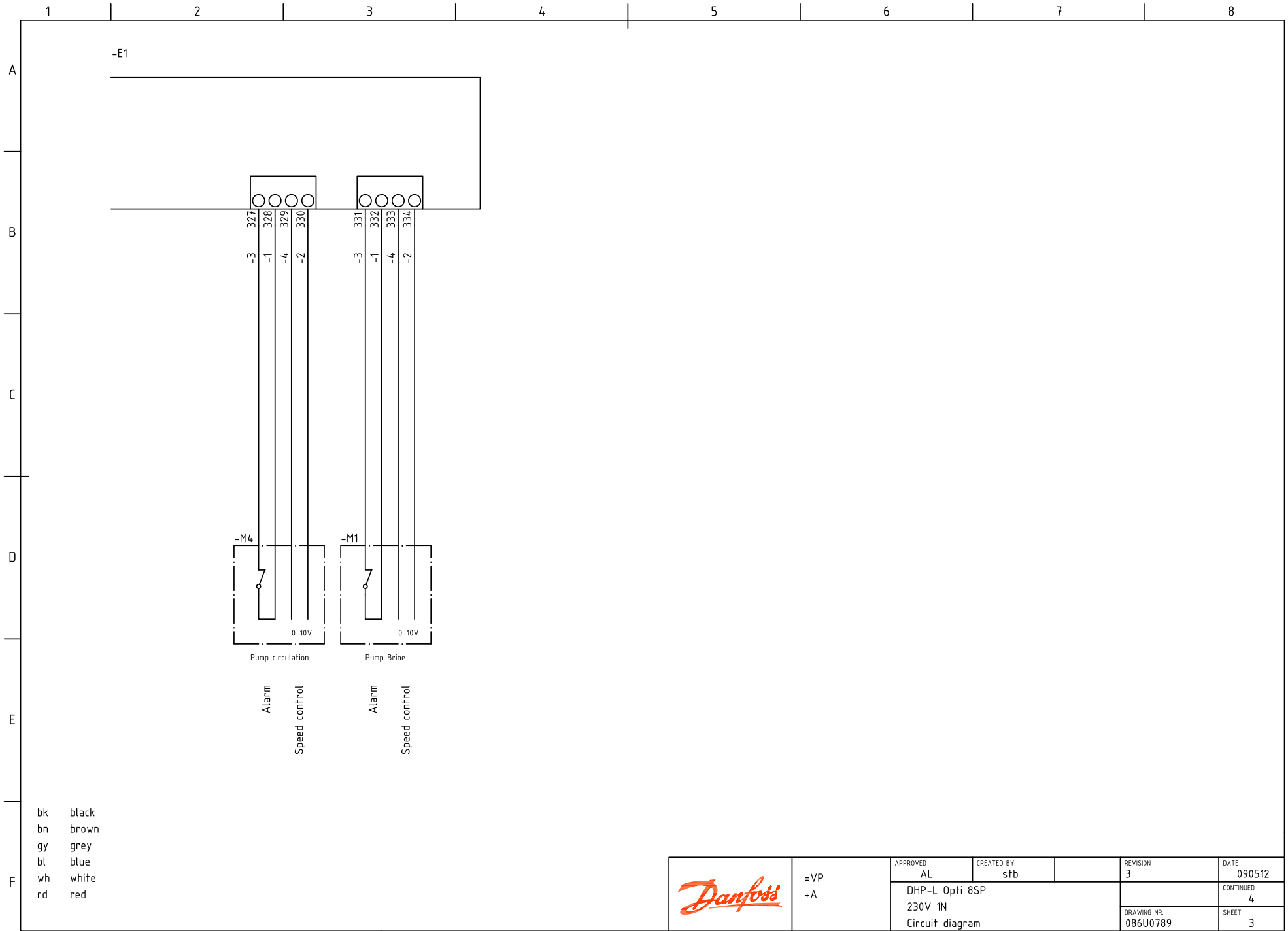

	=VP +A	APPROVED AL	CREATED BY stb	REVISION 3	DATE 090512	
		DHP-L Opti 8SP 230V 1N Circuit diagram			CONTINUED 3	SHEET 2
					DRAWING NR. 086U0789	

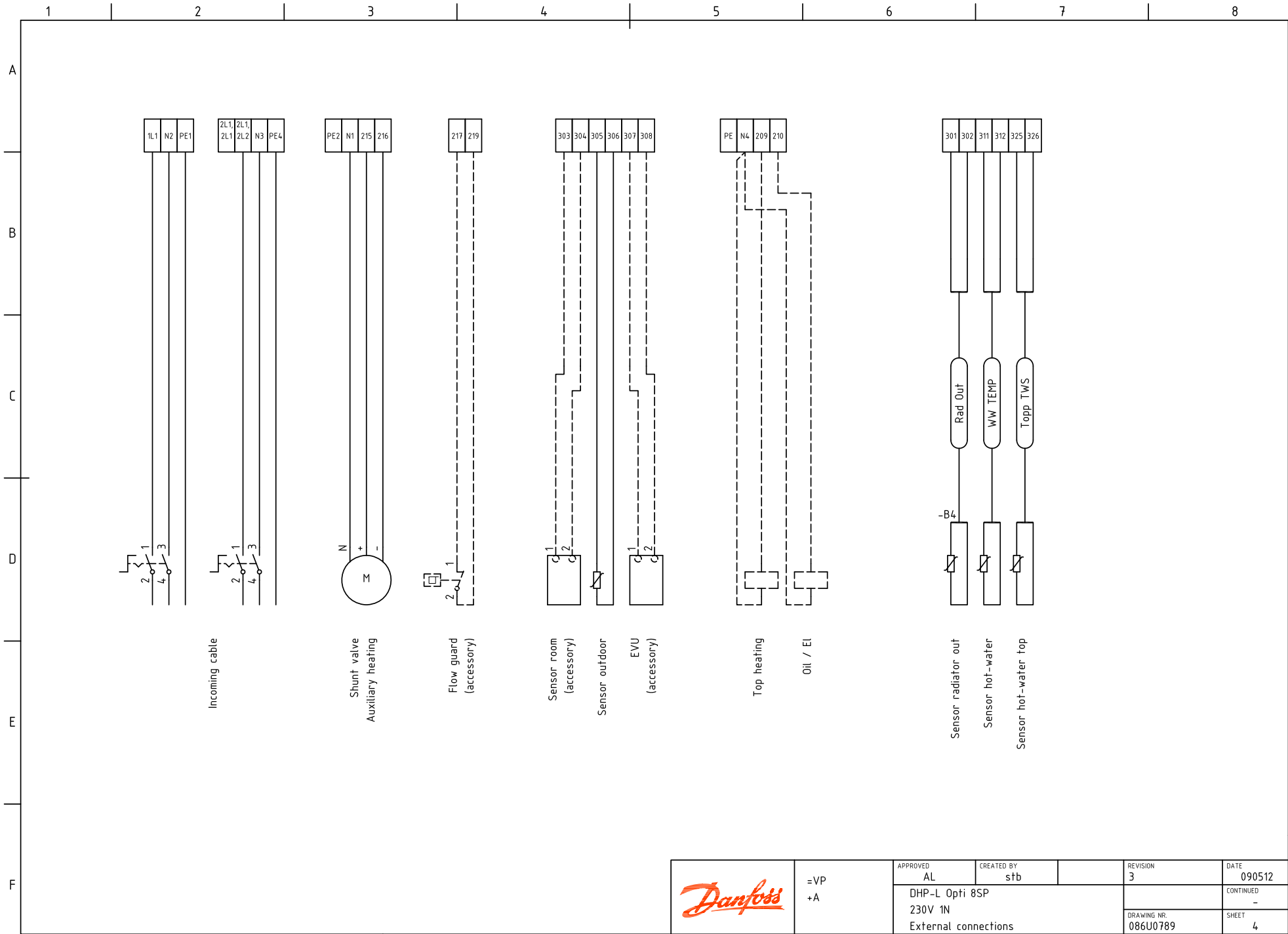

- bk black
- bn brown
- gy grey
- bl blue
- wh white
- rd red

	=VP +A	APPROVED AL	CREATED BY stb	REVISION 3	DATE 090512	
		DHP-L Opti 8SP 230V 1N Circuit diagram			CONTINUED 4	SHEET 3
					DRAWING NR. 086U0789	



	=VP +A	APPROVED	CREATED BY	REVISION	DATE
		AL	stb	3	090512
		DHP-L Opti 8SP 230V 1N External connections			
				DRAWING NR.	SHEET
				086U0789	4

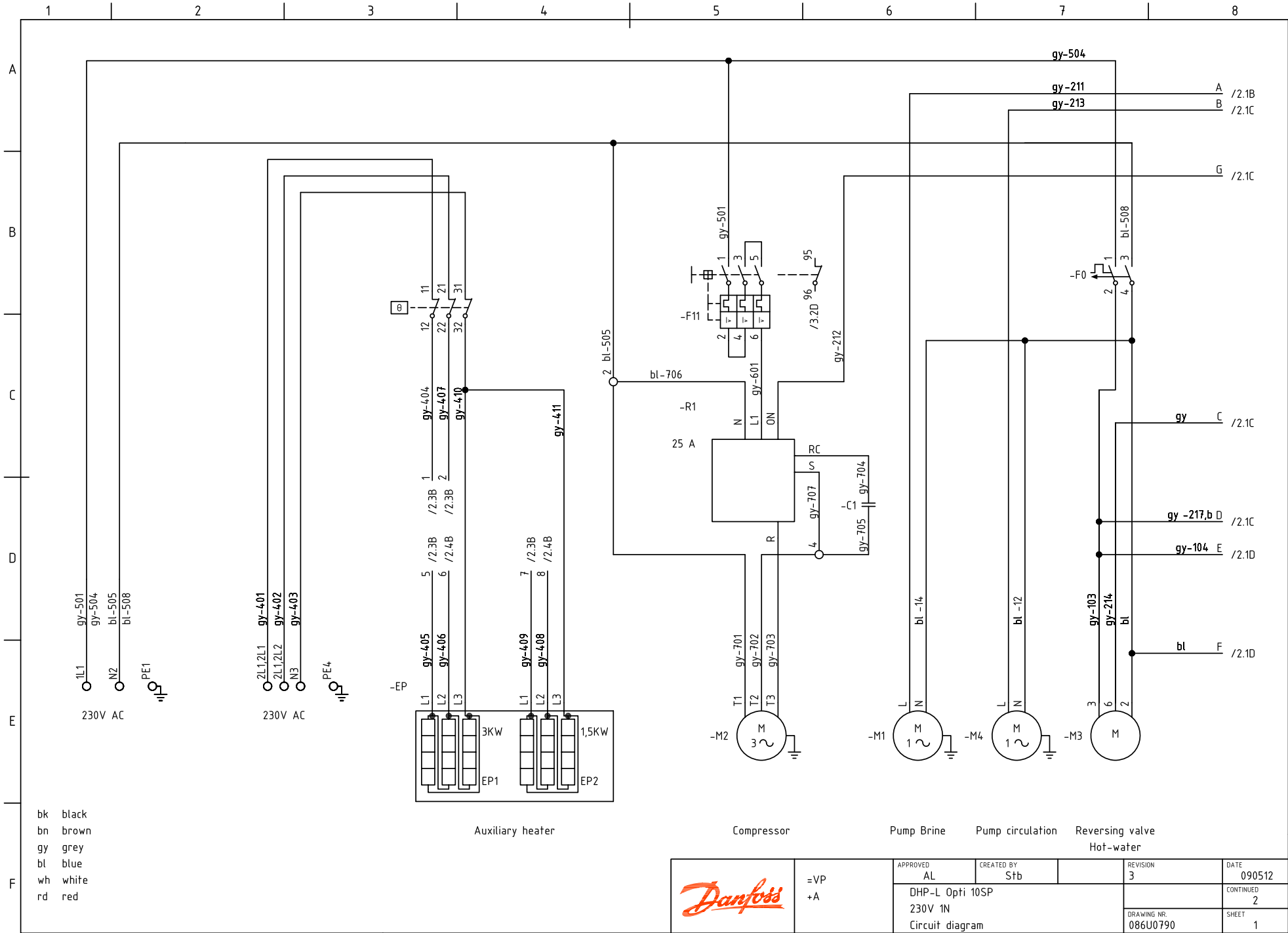

bk black
 bn brown
 gy grey
 bl blue
 wh white
 rd red

Auxiliary heater

Compressor

Pump Brine

Pump circulation

Reversing valve
 Hot-water

	=VP +A	APPROVED AL	CREATED BY Stb	REVISION 3	DATE 090512	
		DHP-L Opti 10SP 230V 1N Circuit diagram			CONTINUED 2	SHEET 1
		DRAWING NR. 086U0790			SHEET 1	

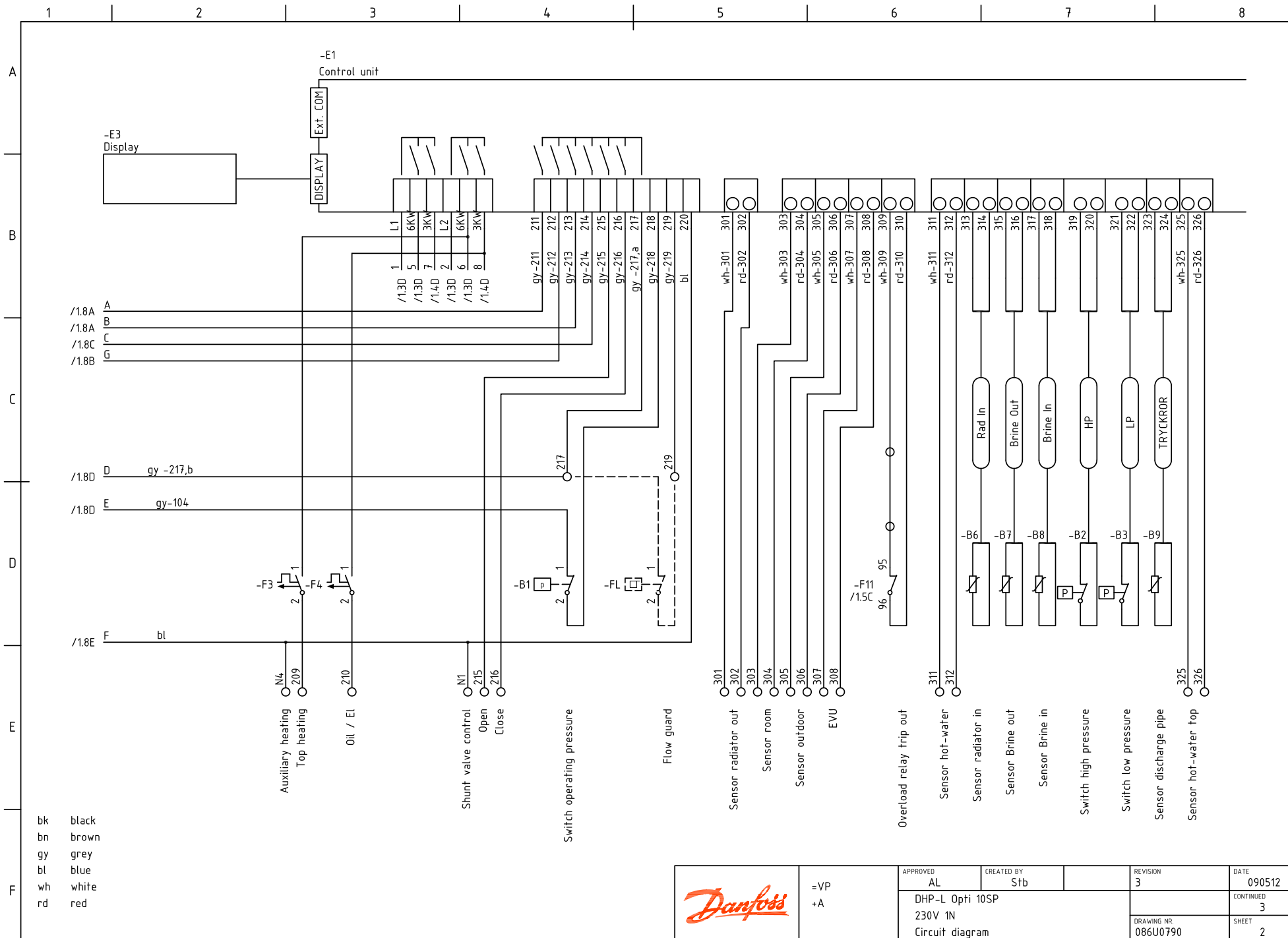

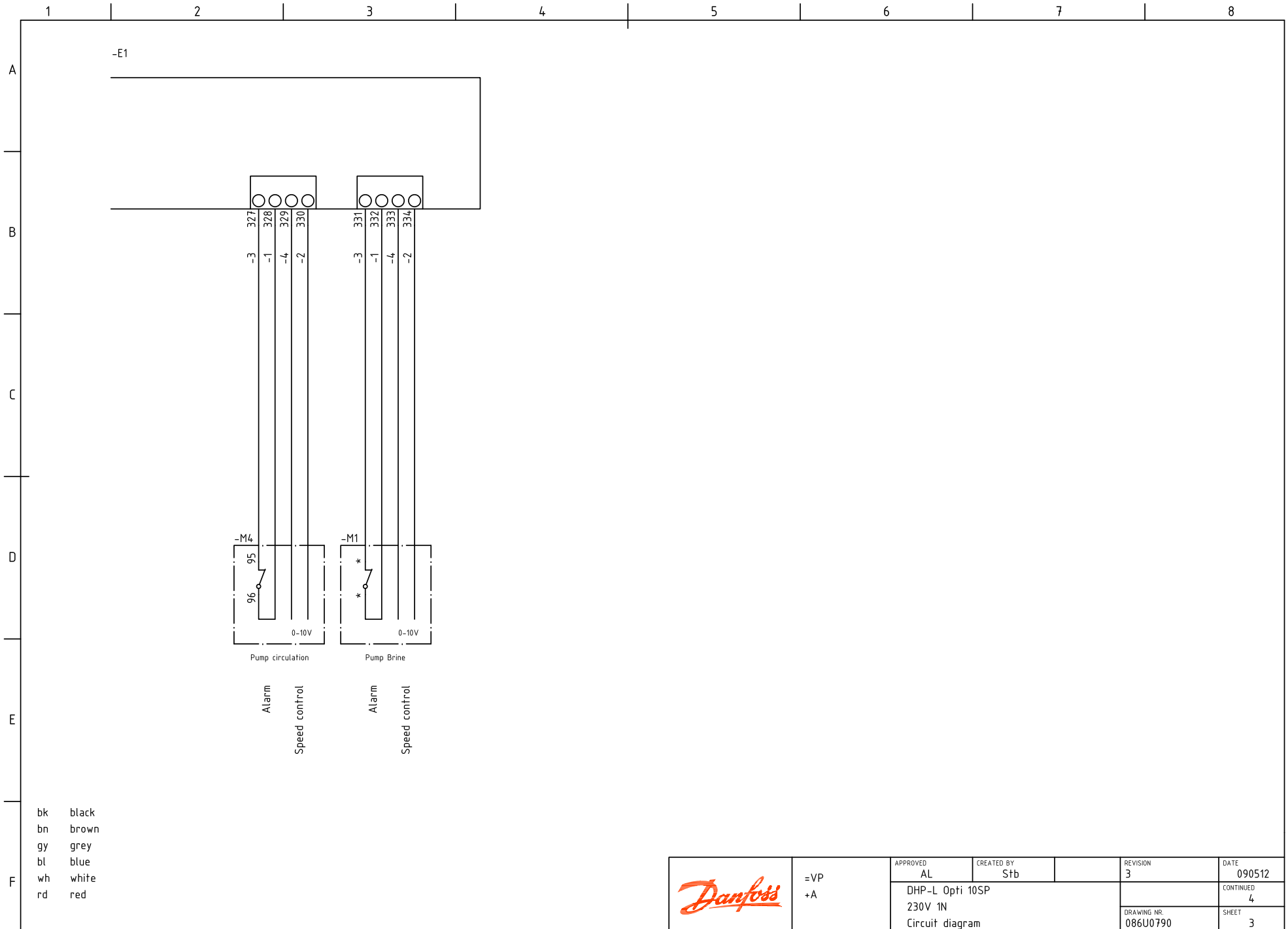

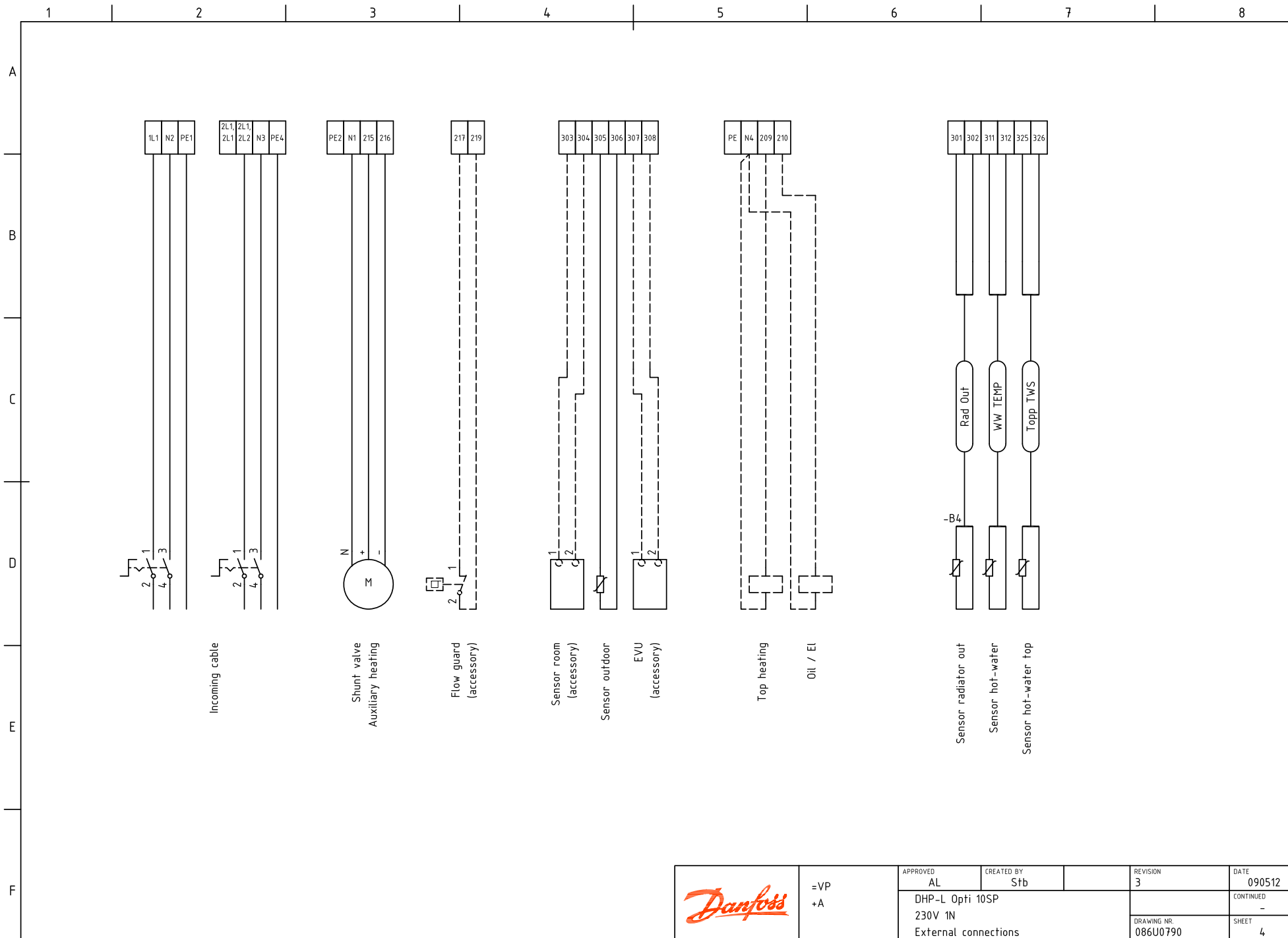

	=VP +A	APPROVED	CREATED BY	REVISION	DATE
		AL	Sth	3	090512
		DHP-L Opti 10SP 230V 1N External connections			
				DRAWING NR.	4
				086U0790	

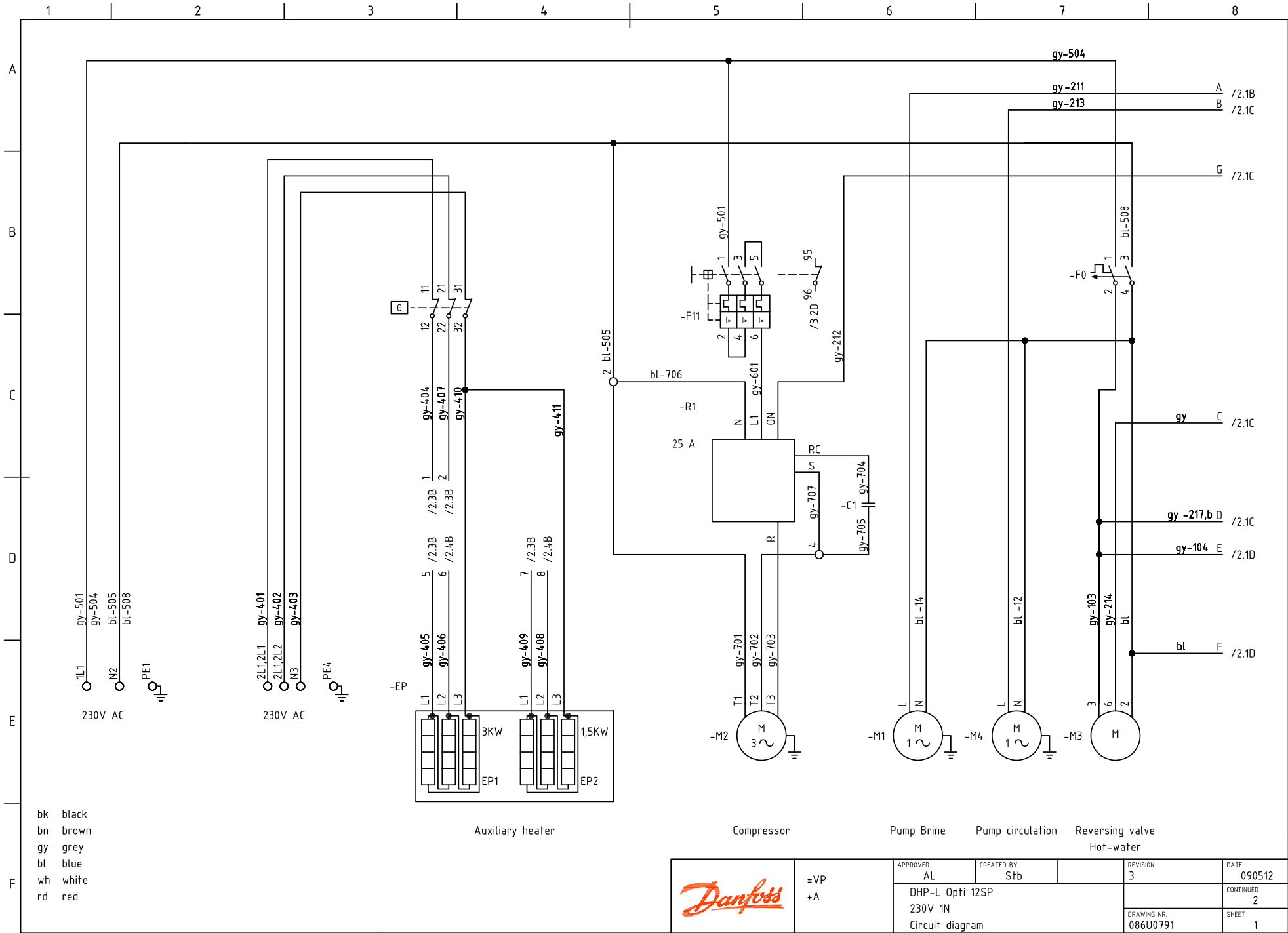

- bk black
- bn brown
- gy grey
- bl blue
- wh white
- rd red

Auxiliary heater

Compressor

Pump Brine

Pump circulation

Reversing valve
Hot-water

	=VP +A	APPROVED AL	CREATED BY Stb	REVISION 3	DATE 090512	
		DHP-L Opti 12SP 230V 1N Circuit diagram			CONTINUED 2	SHEET 1
					DRAWING NR. 086U0791	

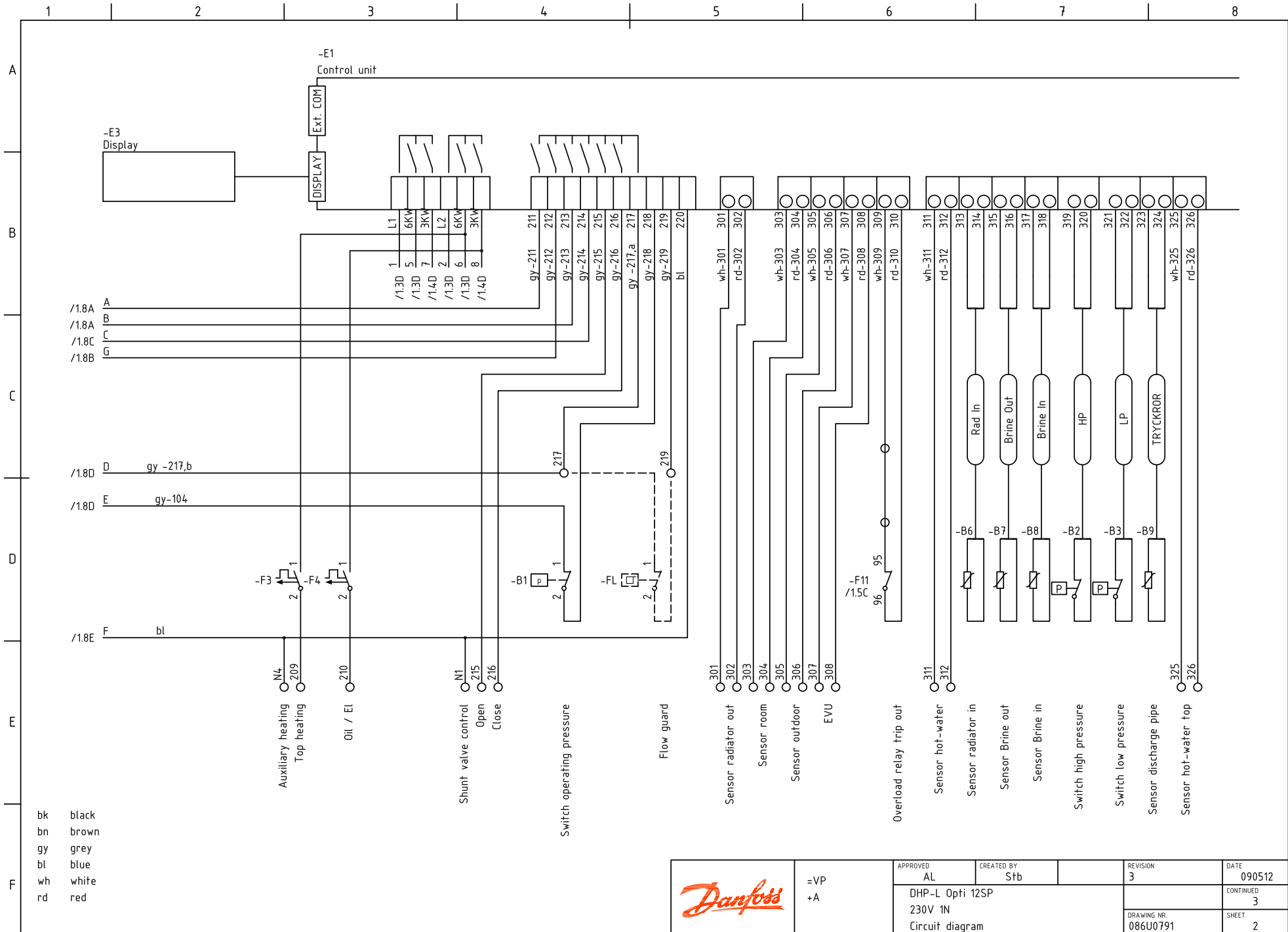

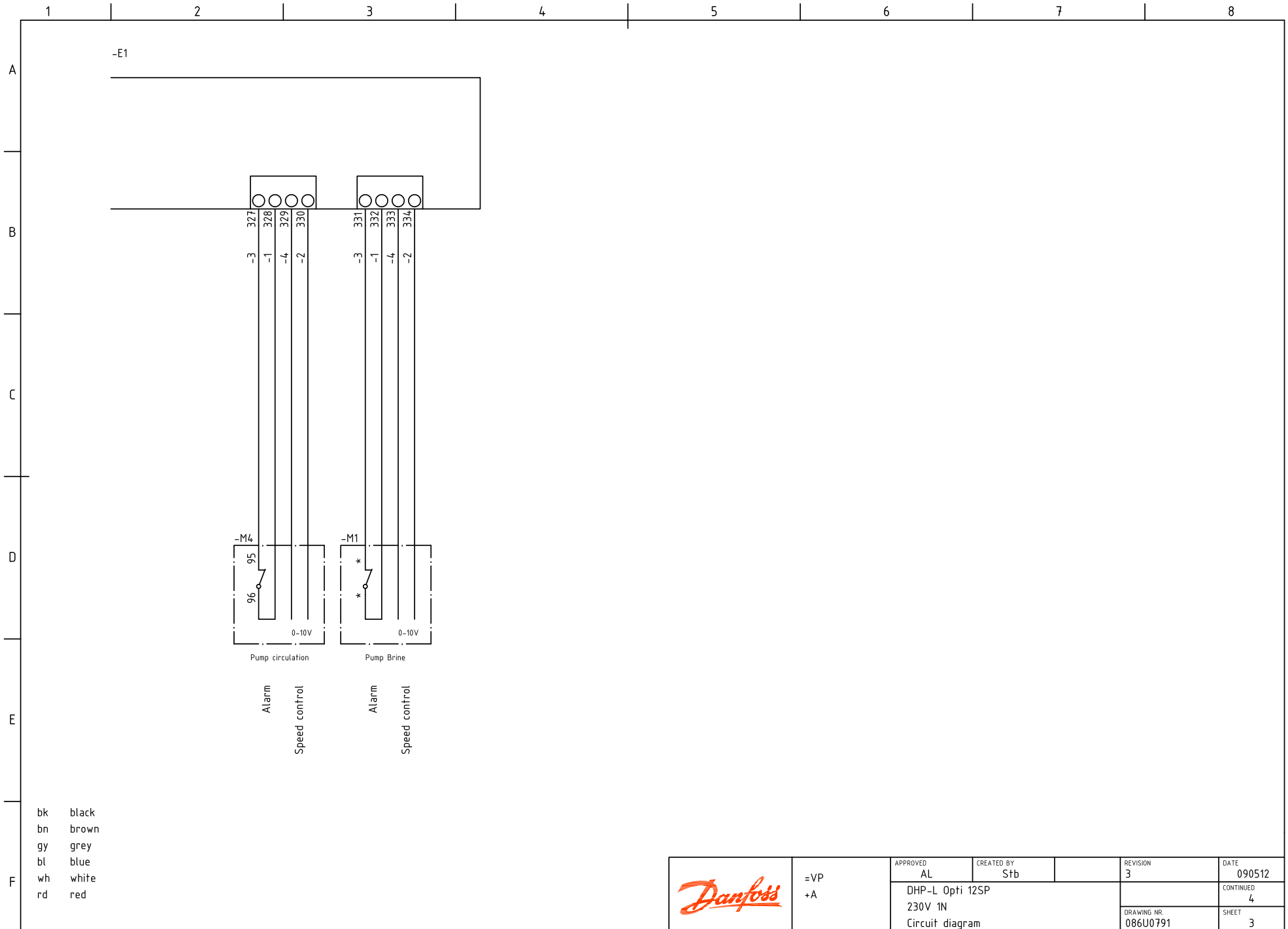

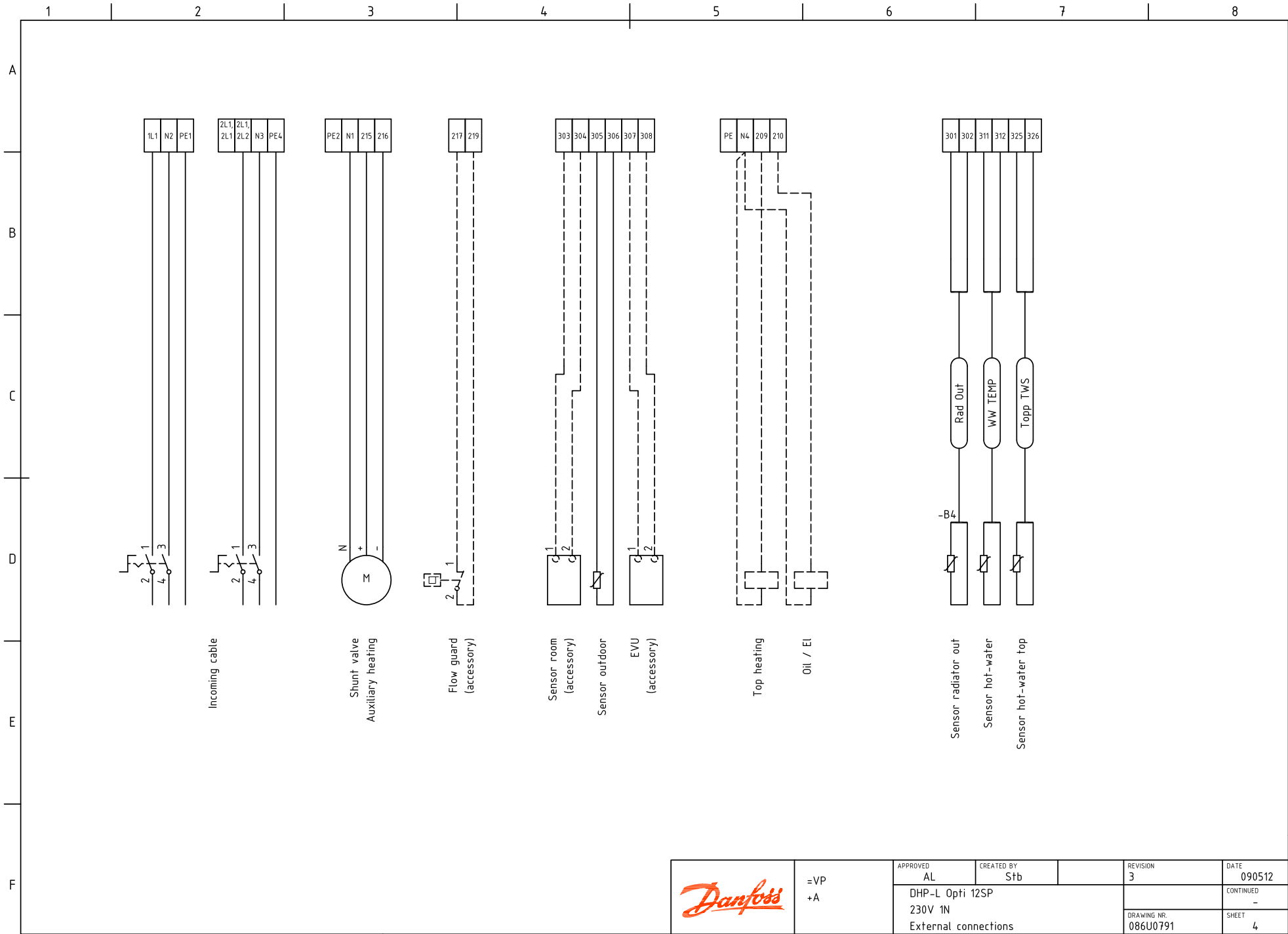

	=VP +A	APPROVED AL	CREATED BY Stb	REVISION 3	DATE 090512
		DHP-L Opti 12SP 230V 1N External connections			CONTINUED -
		DRAWING NR. 086U0791			SHEET 4

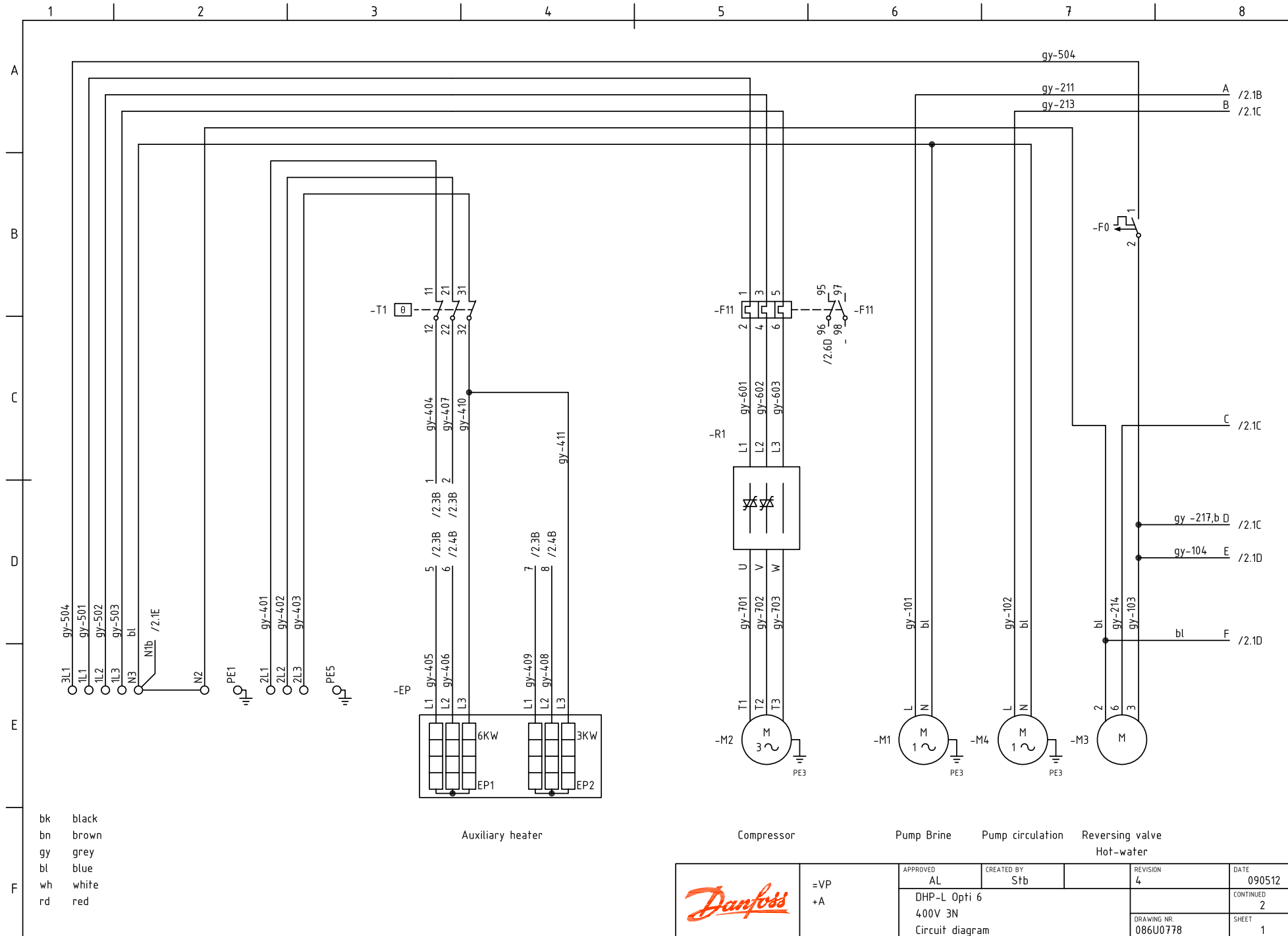

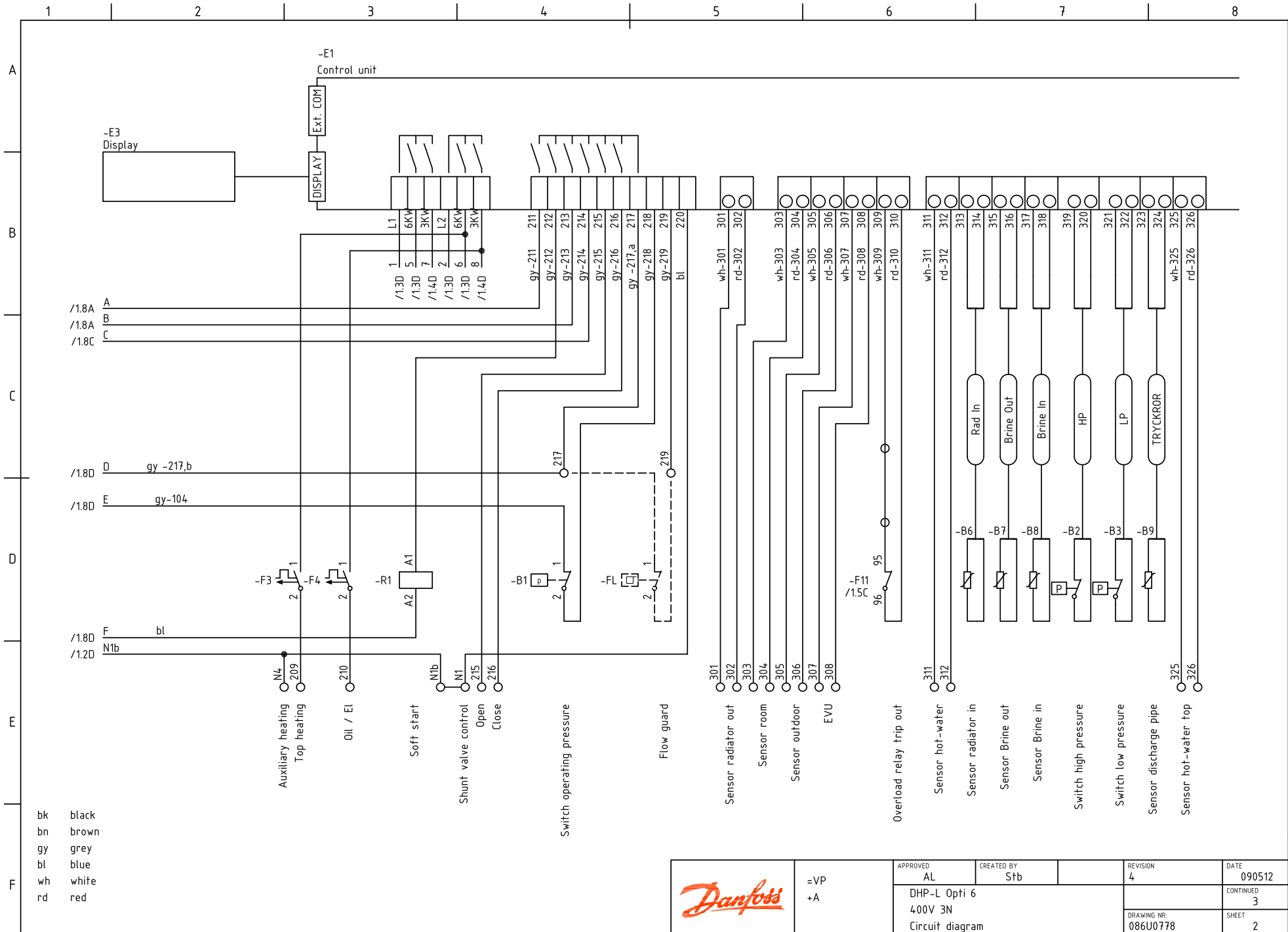

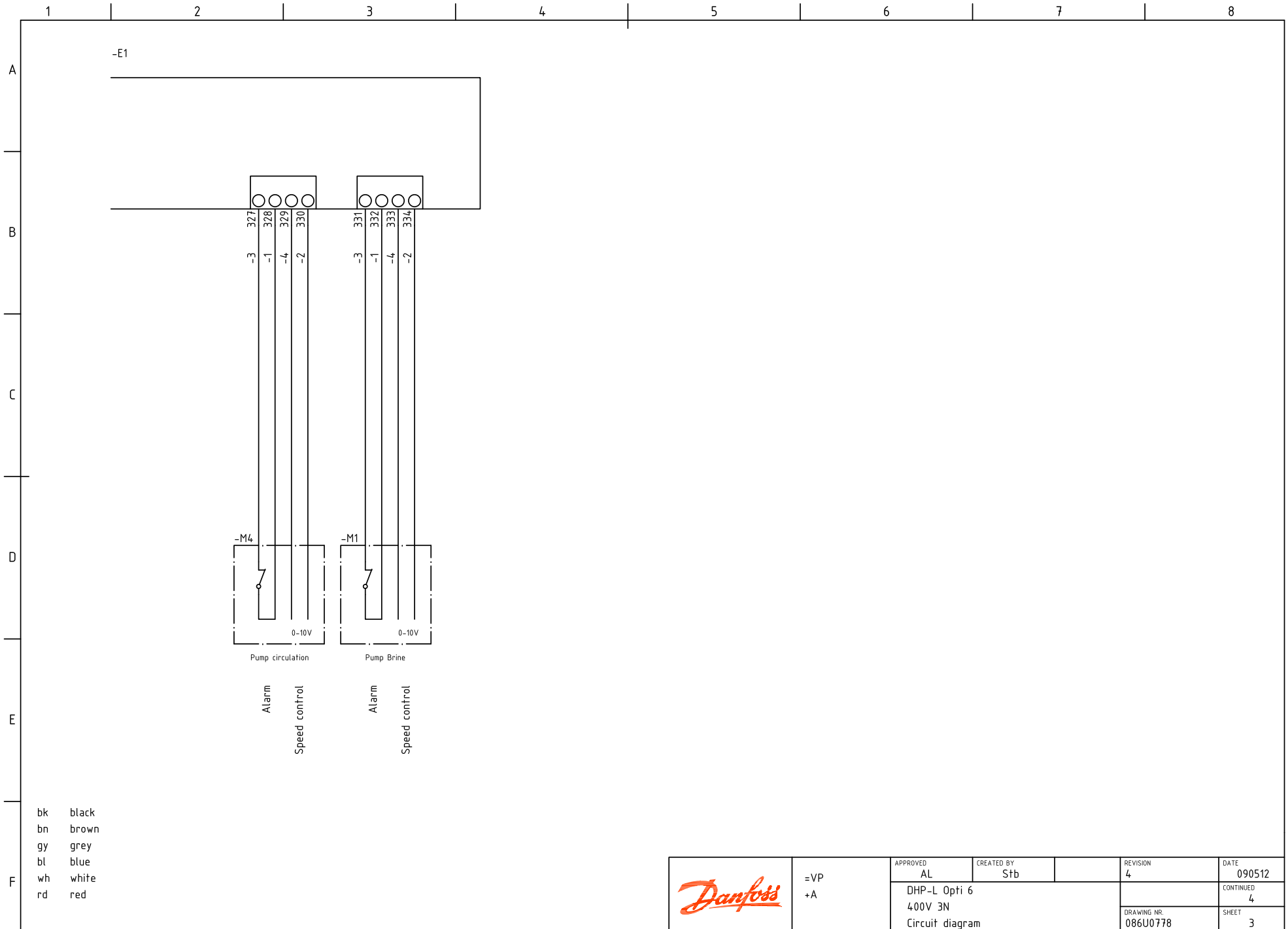

- bk black
- bn brown
- gy grey
- bl blue
- wh white
- rd red

	=VP +A	APPROVED AL	CREATED BY Stb	REVISION 4	DATE 090512
		DHP-L Opti 6 400V 3N Circuit diagram			CONTINUED 4
					DRAWING NR. 086U0778

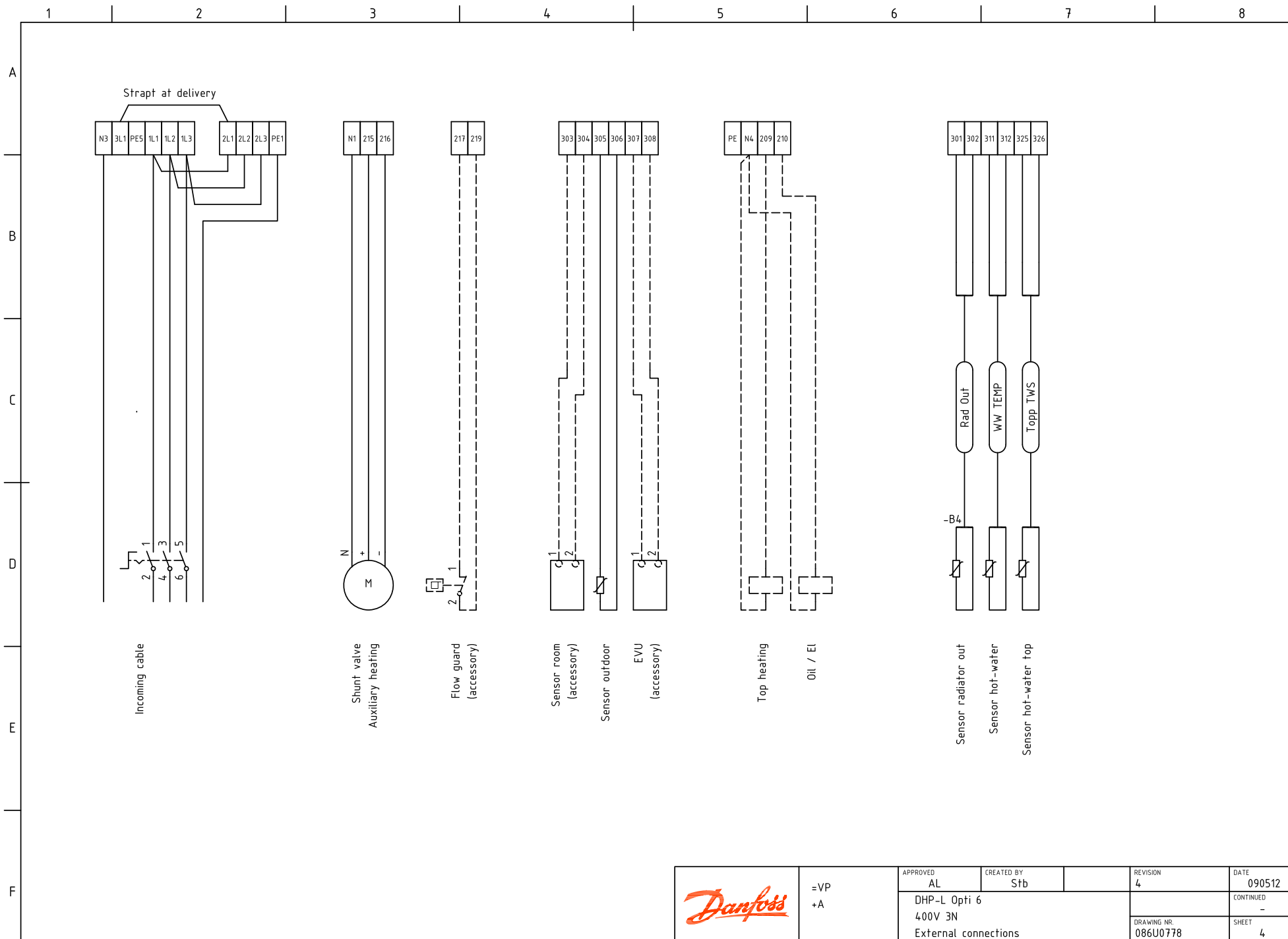

	=VP +A	APPROVED AL	CREATED BY Stb	REVISION 4	DATE 090512	
		DHP-L Opti 6 400V 3N External connections				CONTINUED -
					DRAWING NR. 086U0778	SHEET 4

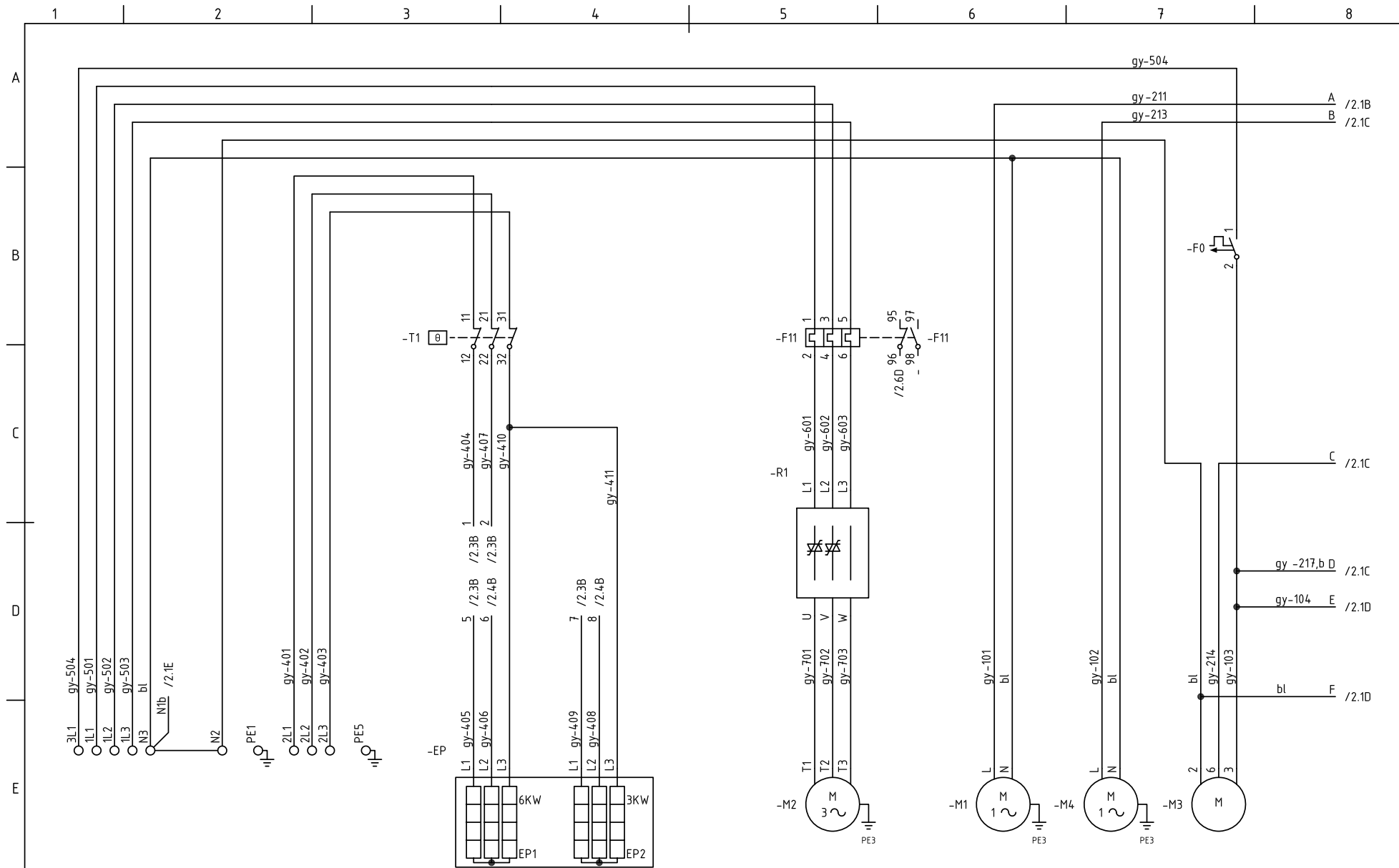

- bk black
- bn brown
- gy grey
- bl blue
- wh white
- rd red

Auxiliary heater

Compressor

Pump Brine

Pump circulation

Reversing valve
Hot-water

	=VP +A	APPROVED AL	CREATED BY Stb	REVISION 4	DATE 090512	
		DHP-L Opti 8 400V 3N Circuit diagram			CONTINUED 2	SHEET 1
					DRAWING NR. 086U0779	

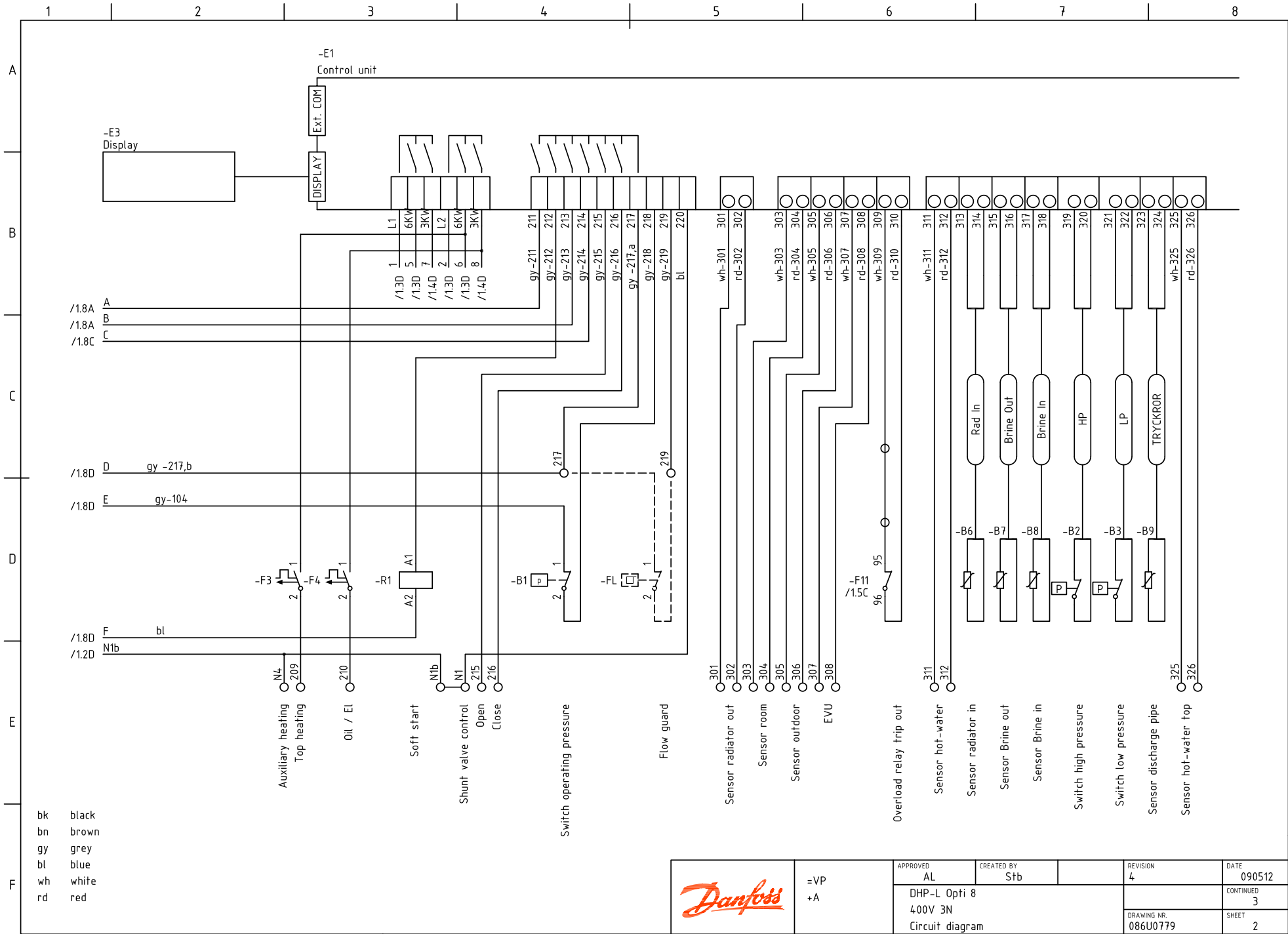

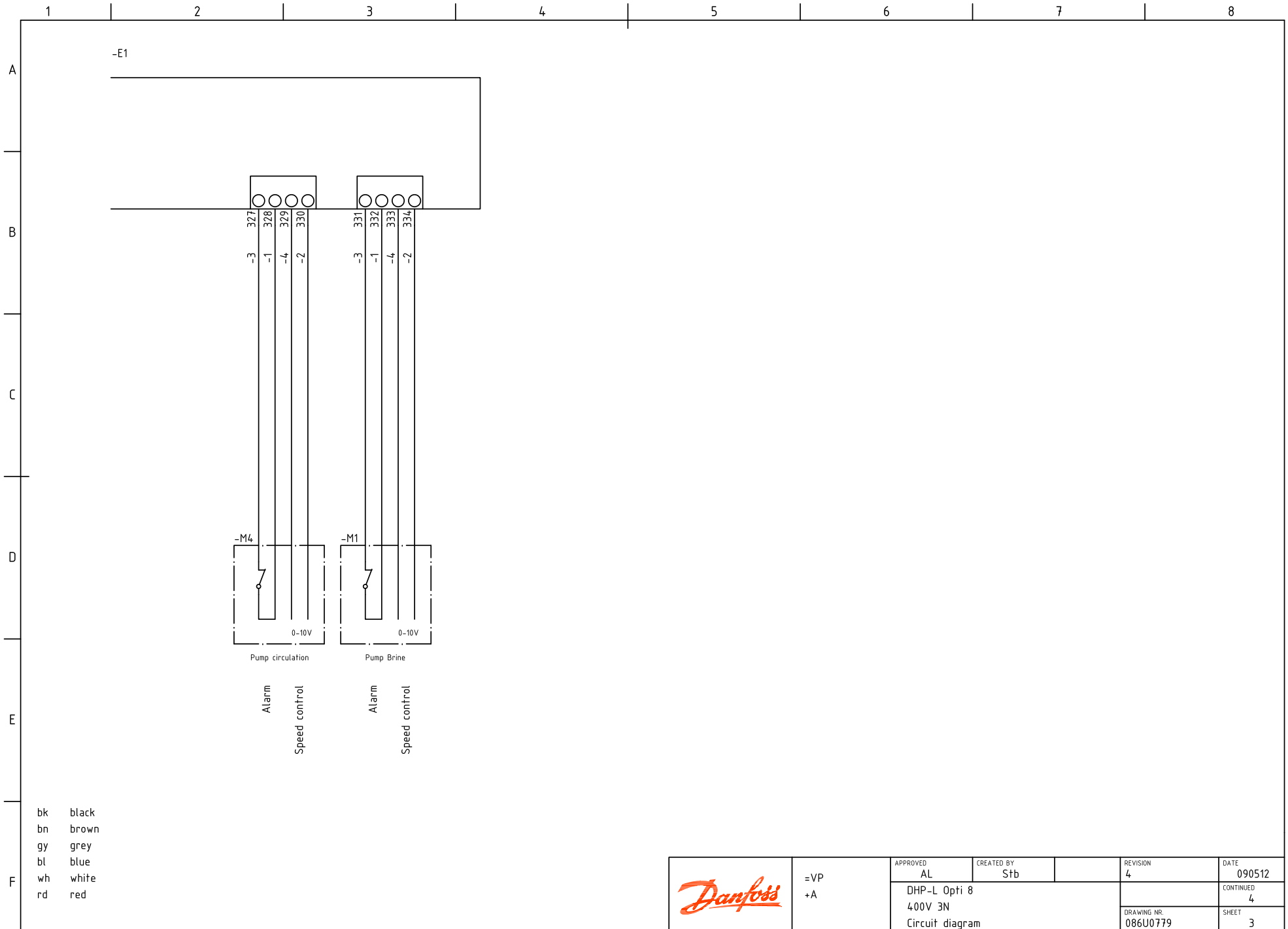

- bk black
- bn brown
- gy grey
- bl blue
- wh white
- rd red

	=VP +A	APPROVED AL	CREATED BY Stb	REVISION 4	DATE 090512	
		DHP-L Opti 8 400V 3N Circuit diagram			CONTINUED 4	SHEET 3
					DRAWING NR. 086U0779	

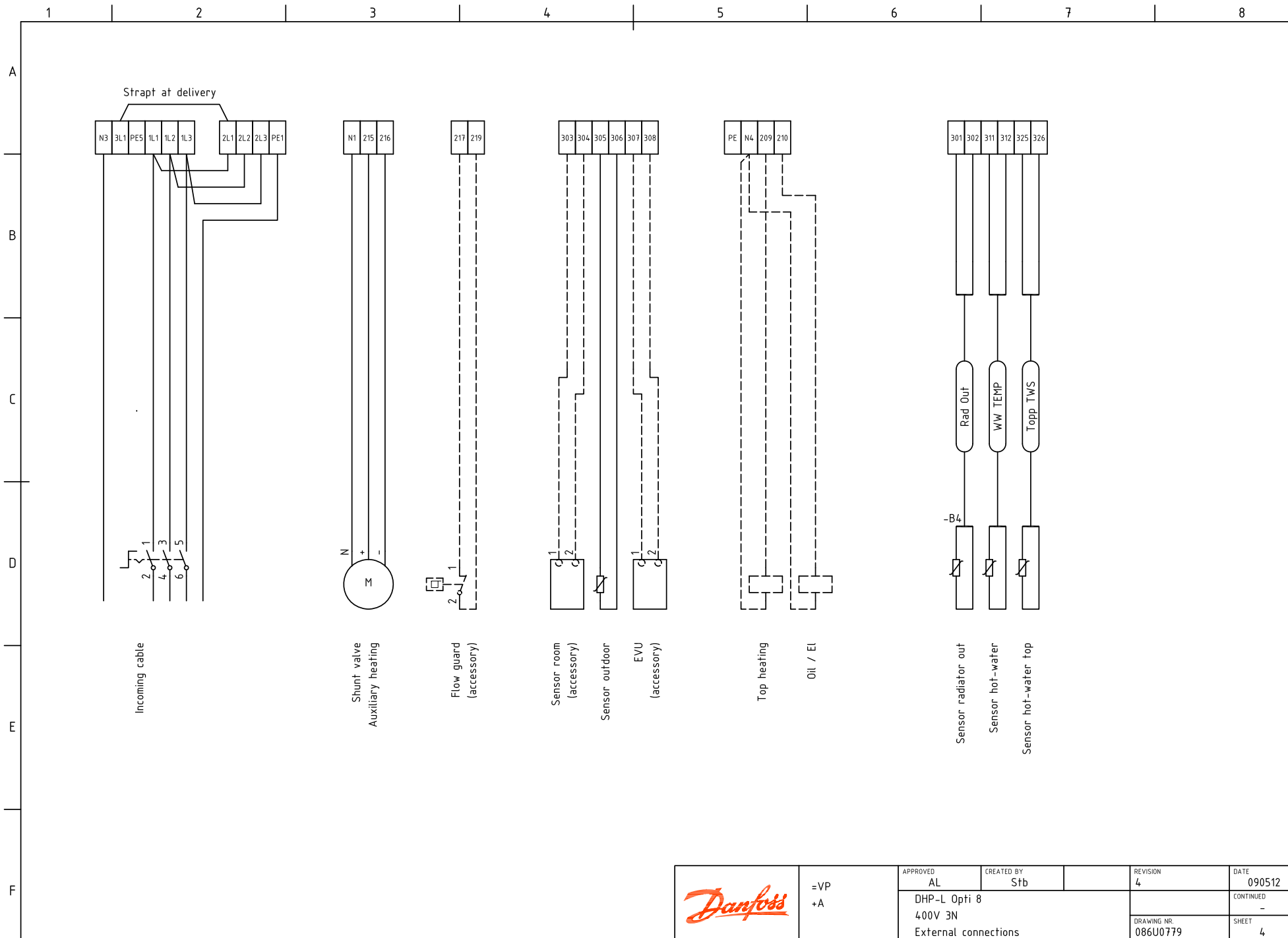

	=VP +A	APPROVED AL	CREATED BY Stb	REVISION 4	DATE 090512	
		DHP-L Opti 8 400V 3N External connections				CONTINUED -
					DRAWING NR. 086U0779	SHEET 4

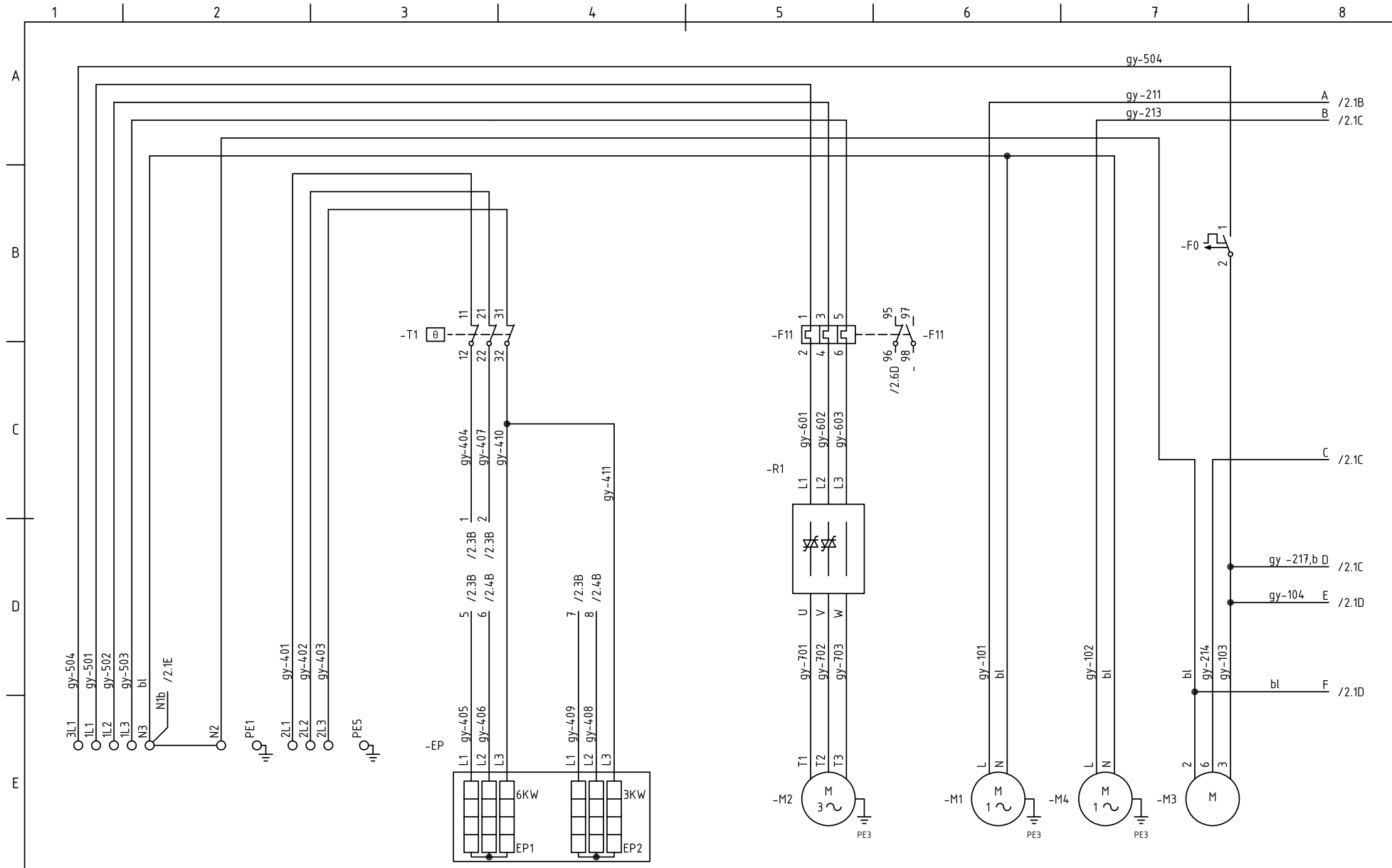

- bk black
- bn brown
- gy grey
- bl blue
- wh white
- rd red

Auxiliary heater

Compressor

Pump Brine

Pump circulation

Reversing valve
Hot-water

	=VP +A	APPROVED AL	CREATED BY Stb	REVISION 4	DATE 090512	
		DHP-L Opti 10 400V 3N Circuit diagram			CONTINUED 2	SHEET 1
					DRAWING NR. 086U0780	

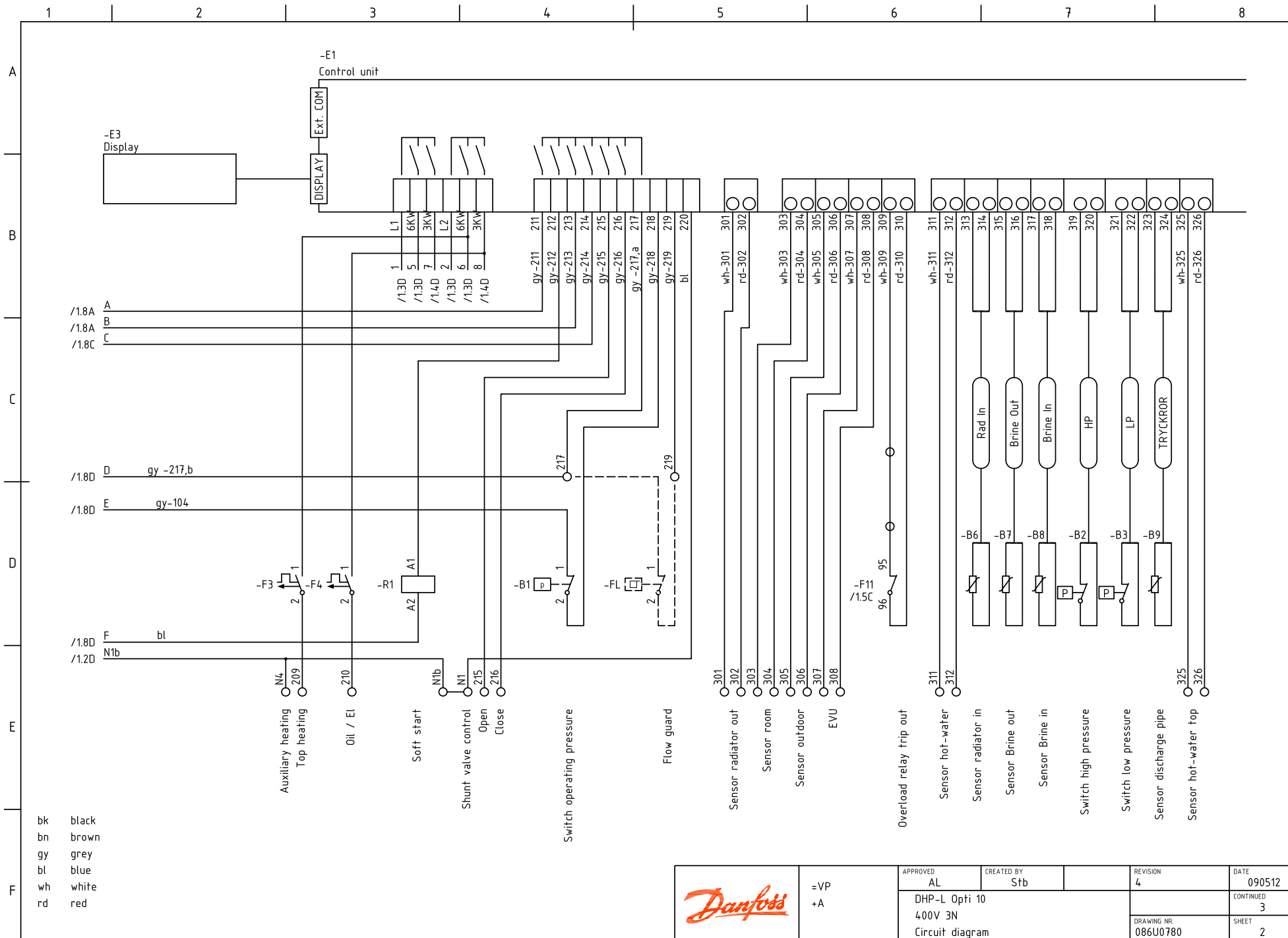

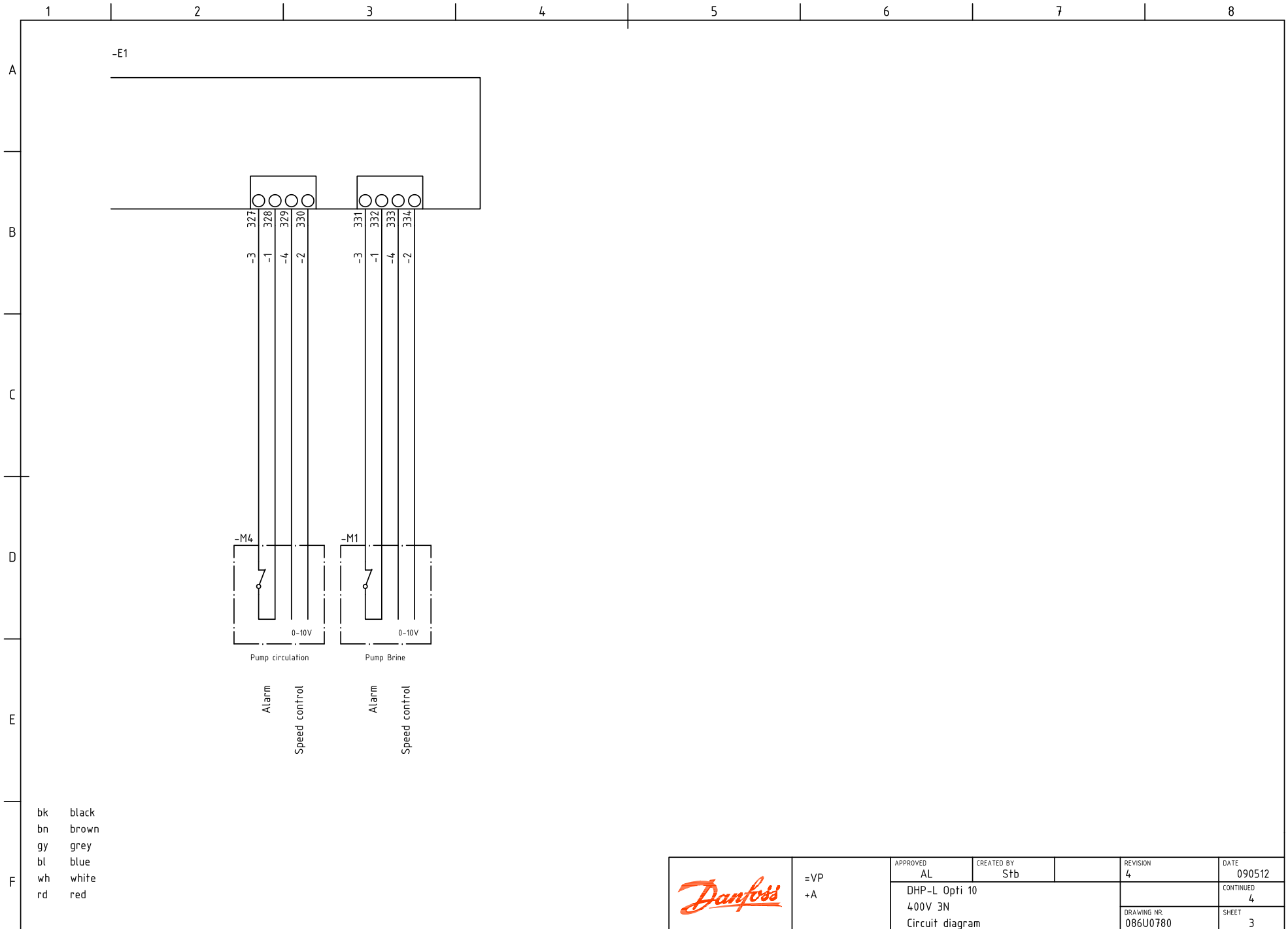

	=VP +A	APPROVED AL	CREATED BY Stb	REVISION 4	DATE 090512	
		DHP-L Opti 10 400V 3N Circuit diagram			DRAWING NR. 086U0780	CONTINUED 3
					SHEET 2	

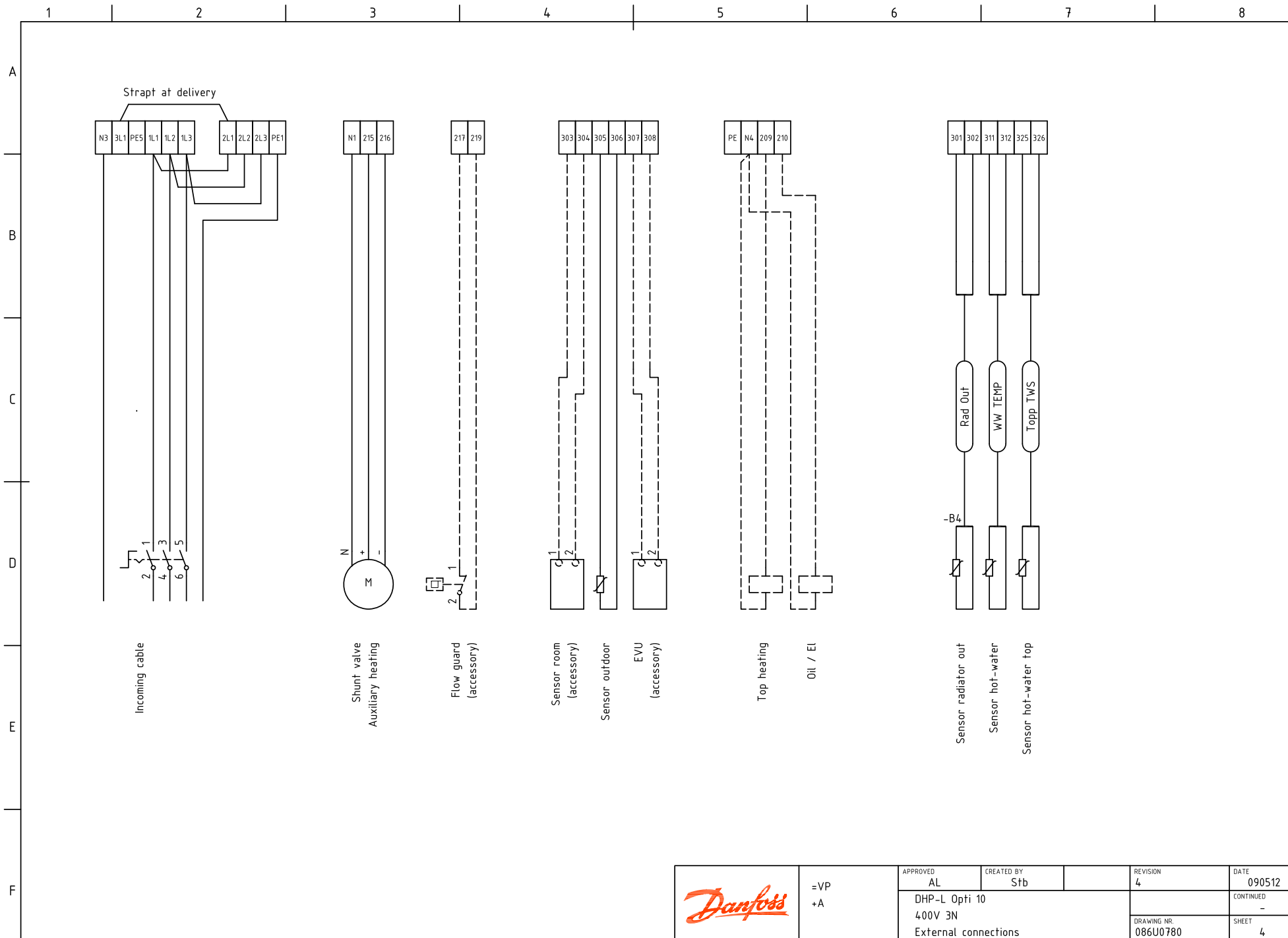

- bk black
- bn brown
- gy grey
- bl blue
- wh white
- rd red

	=VP +A	APPROVED AL	CREATED BY Stb	REVISION 4	DATE 090512	
		DHP-L Opti 10 400V 3N Circuit diagram			CONTINUED 4	SHEET 4
					DRAWING NR. 086U0780	SHEET 3



	=VP +A	APPROVED	CREATED BY	REVISION	DATE	
		AL	Sth	4	090512	
		DHP-L Opti 10				CONTINUED
		400V 3N				-
External connections				DRAWING NR.	SHEET	
				086U0780	4	

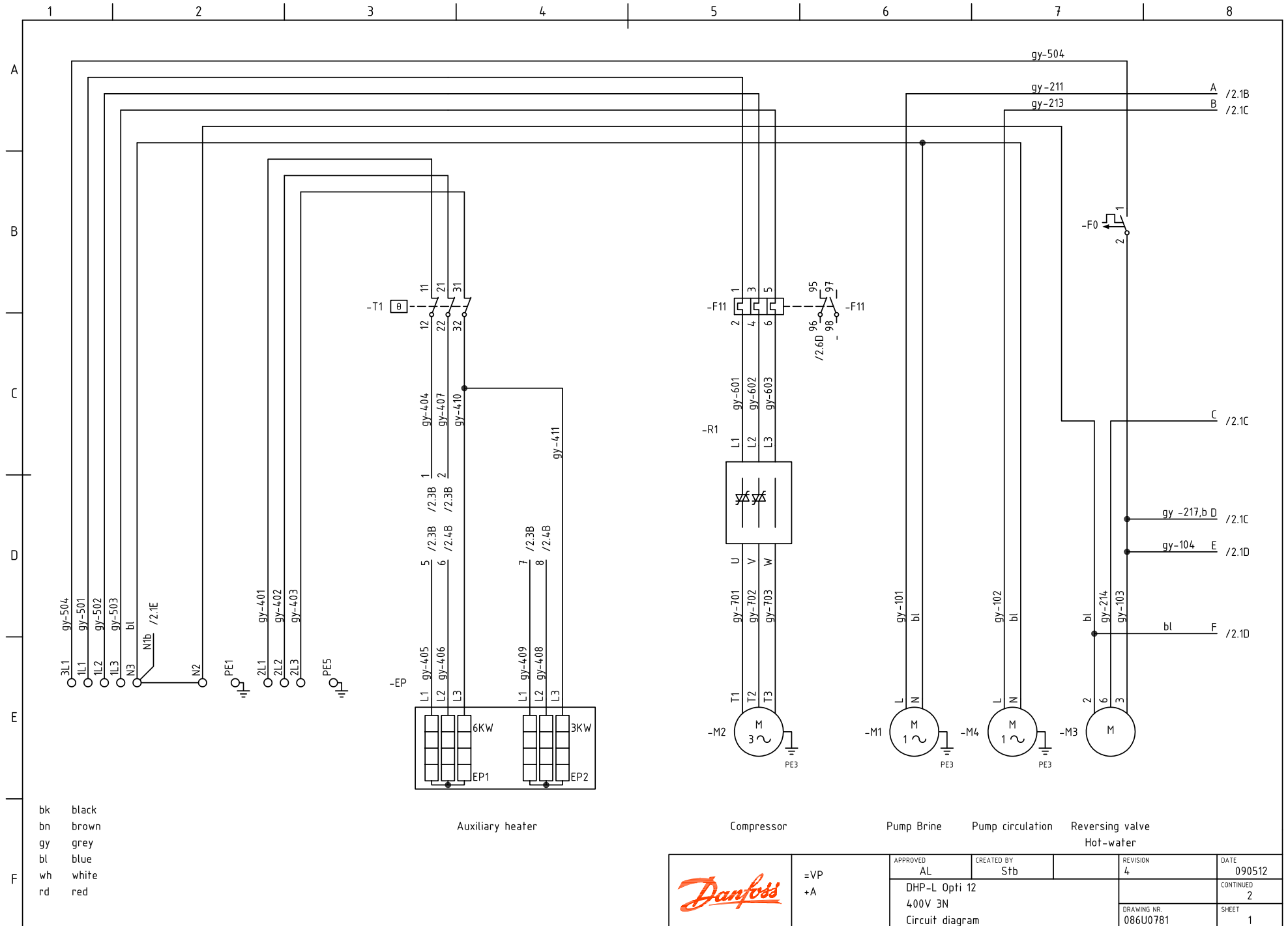

	=VP +A	APPROVED AL	CREATED BY Stb	REVISION 4	DATE 090512
		DHP-L Opti 12 400V 3N Circuit diagram			CONTINUED 2
					DRAWING NR. 086U0781

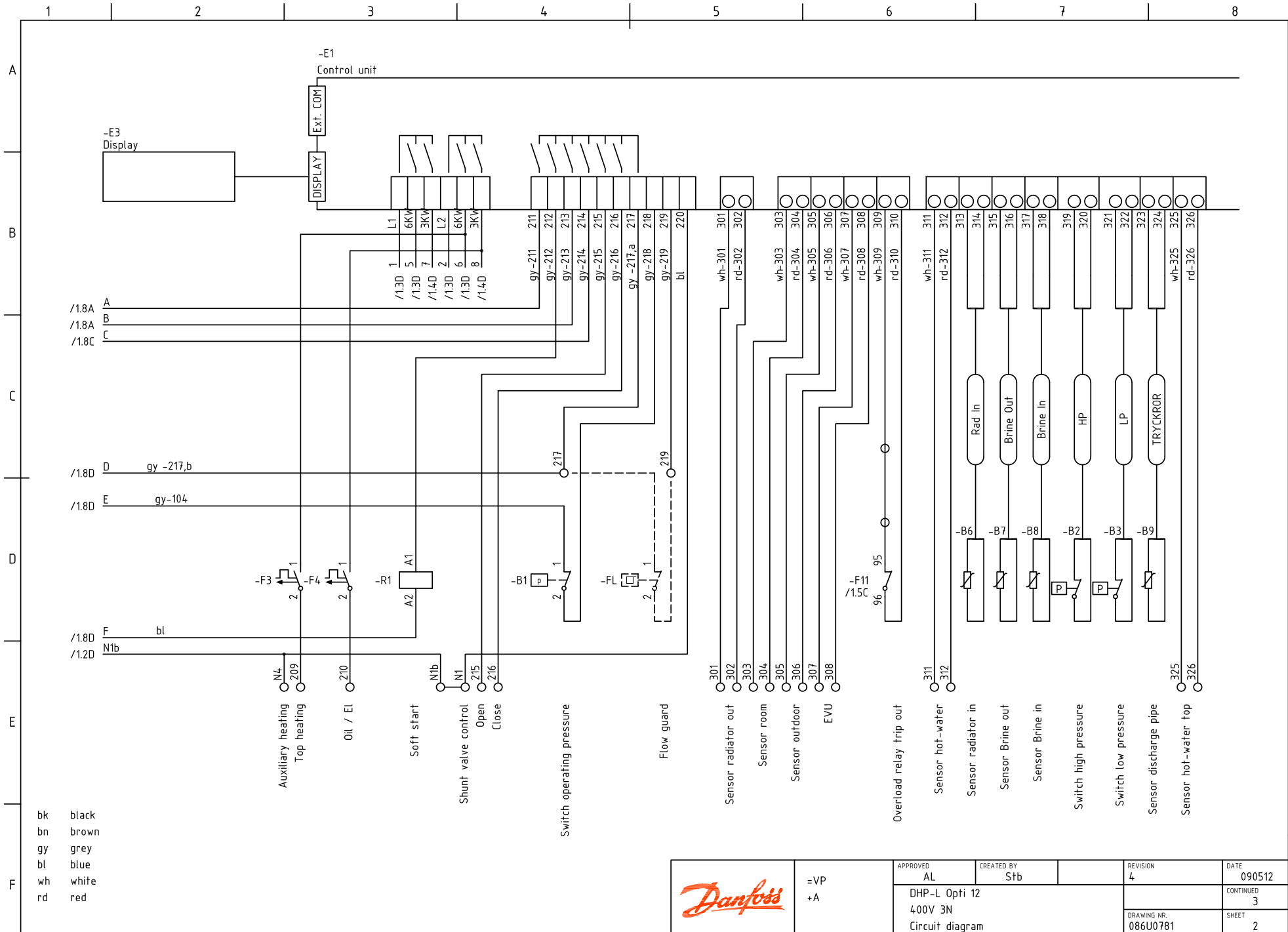

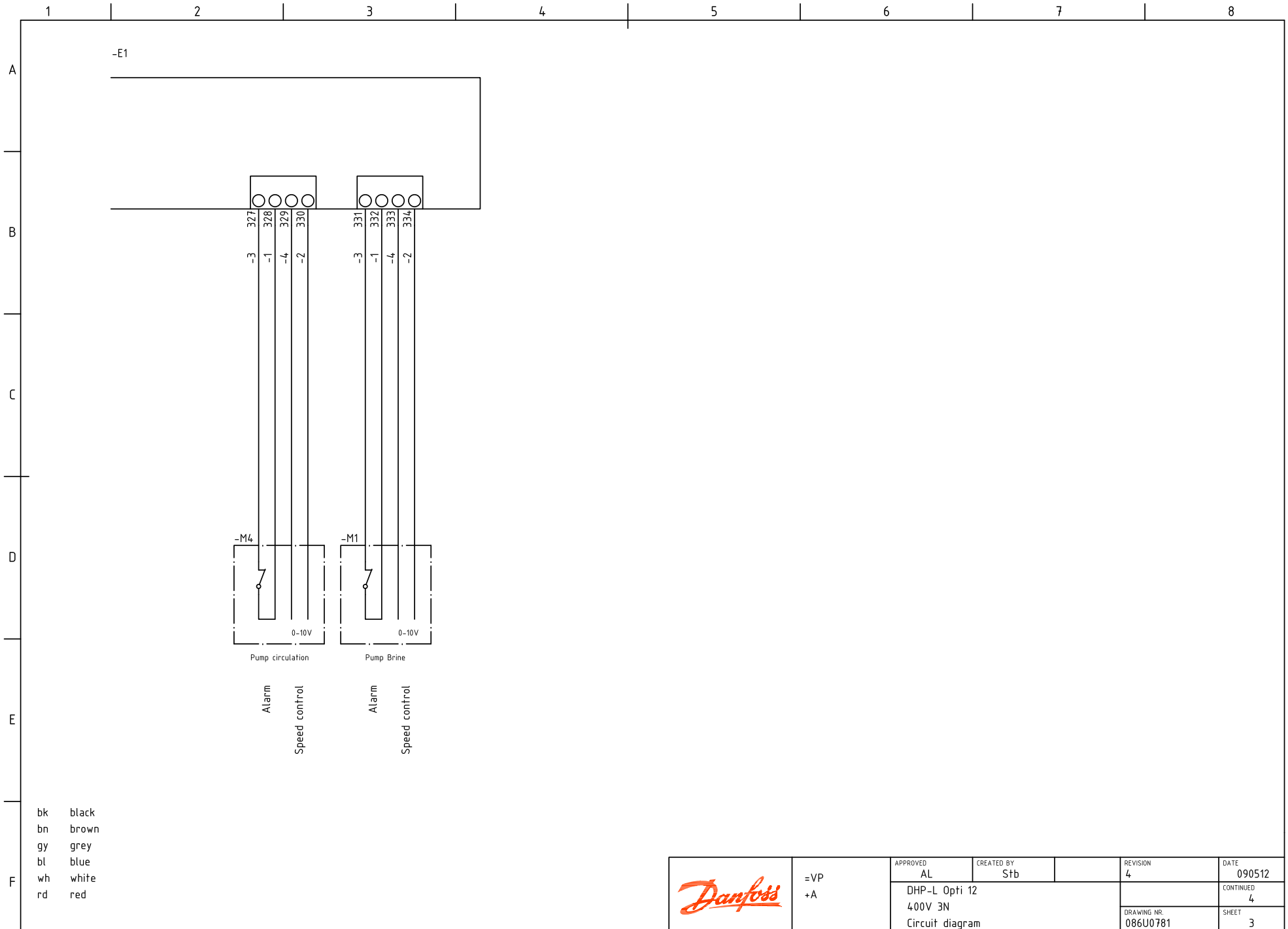

- bk black
- bn brown
- gy grey
- bl blue
- wh white
- rd red

	=VP +A	APPROVED AL	CREATED BY Stb	REVISION 4	DATE 090512	
		DHP-L Opti 12 400V 3N Circuit diagram			DRAWING NR. 086U0781	CONTINUED 4
					SHEET 3	

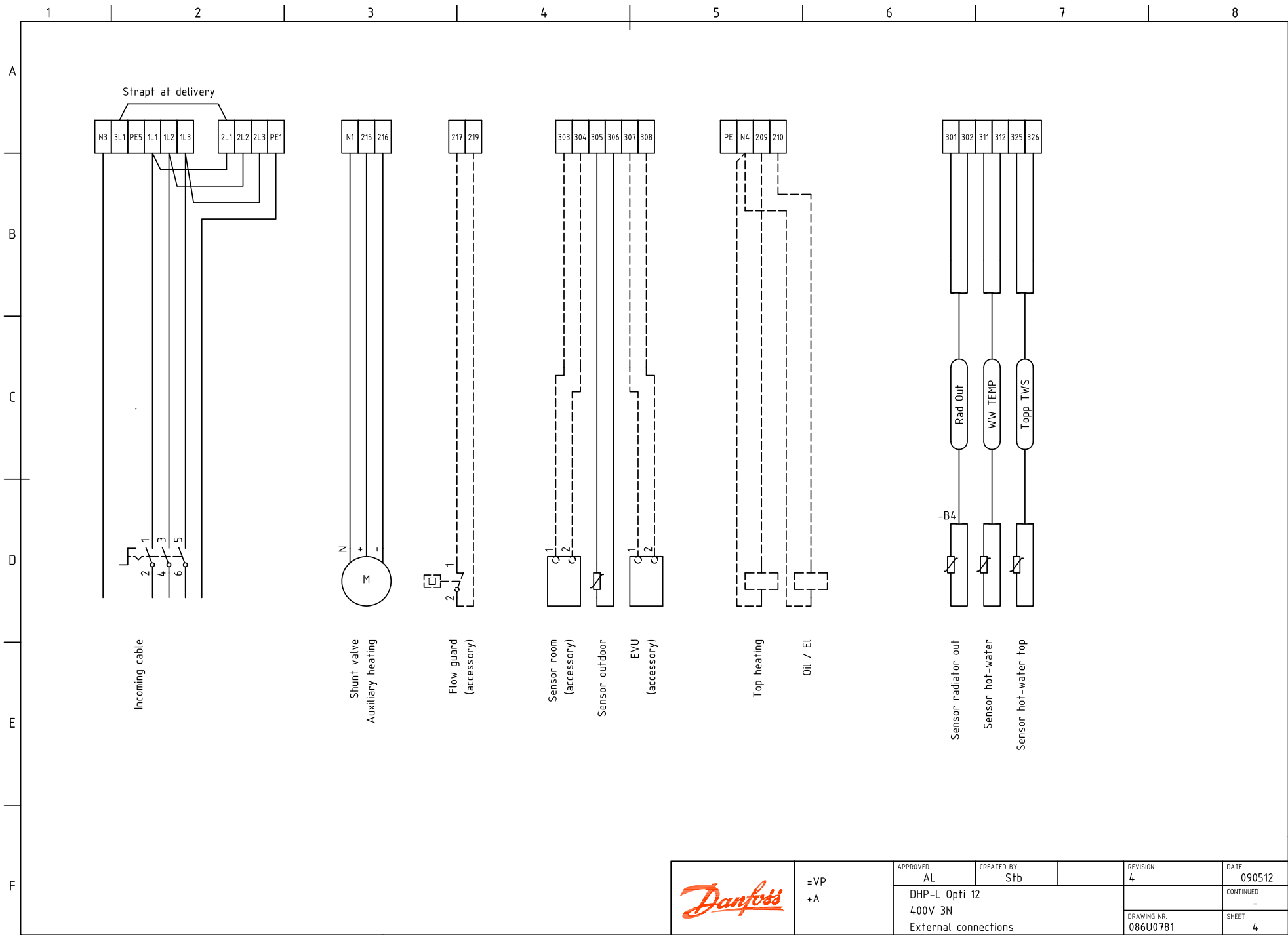

	=VP +A	APPROVED AL	CREATED BY Stb	REVISION 4	DATE 090512
		DHP-L Opti 12 400V 3N External connections			CONTINUED -
					DRAWING NR. 086U0781

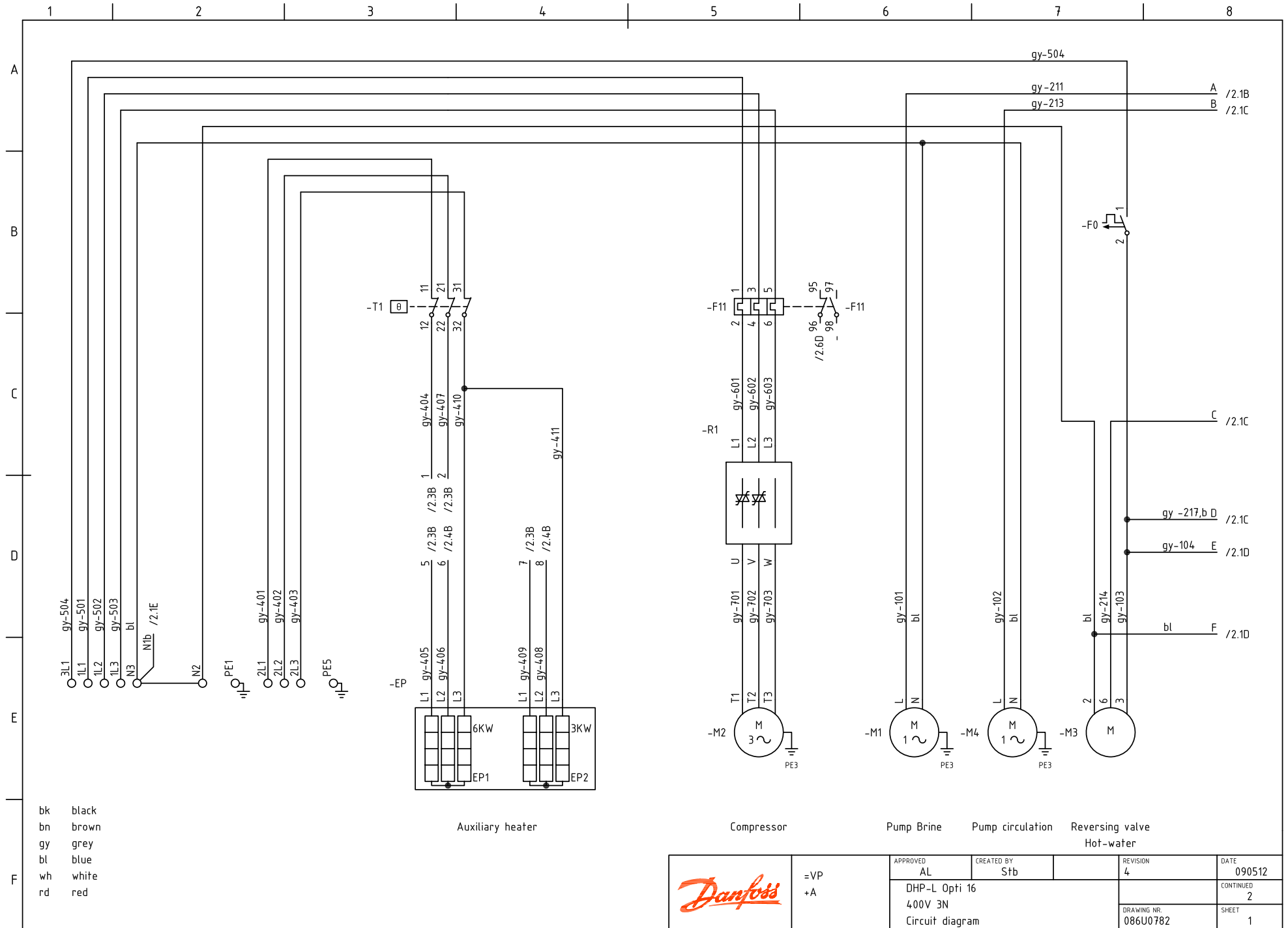

- bk black
- bn brown
- gy grey
- bl blue
- wh white
- rd red

Auxiliary heater

Compressor

Pump Brine

Pump circulation

Reversing valve
Hot-water

	=VP +A	APPROVED AL	CREATED BY Stb	REVISION 4	DATE 090512	
		DHP-L Opti 16 400V 3N Circuit diagram			CONTINUED 2	SHEET 1
					DRAWING NR. 086U0782	

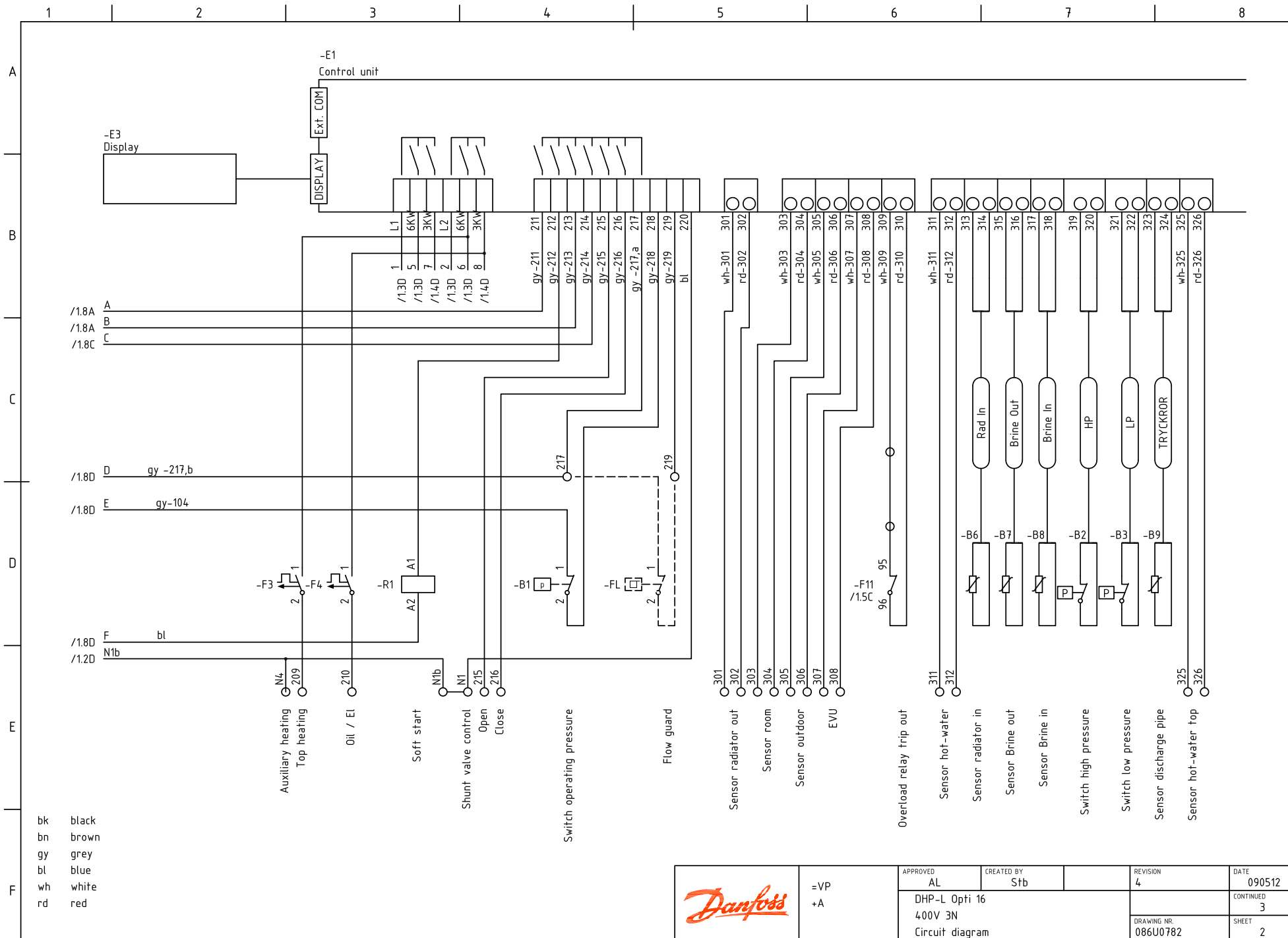

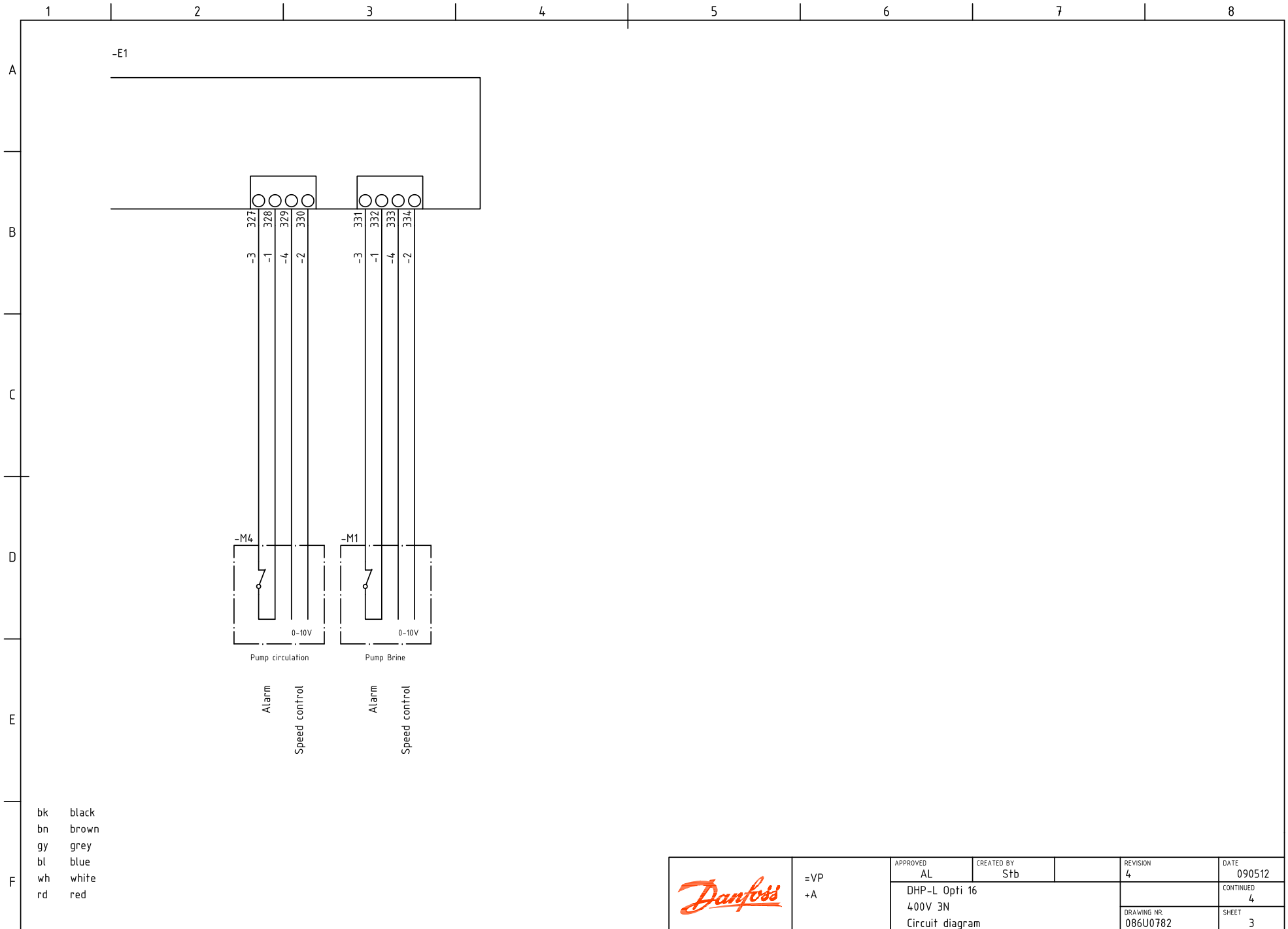

- bk black
- bn brown
- gy grey
- bl blue
- wh white
- rd red

	=VP +A	APPROVED AL	CREATED BY Stb	REVISION 4	DATE 090512	
		DHP-L Opti 16 400V 3N Circuit diagram				CONTINUED 4
					DRAWING NR. 086U0782	SHEET 3

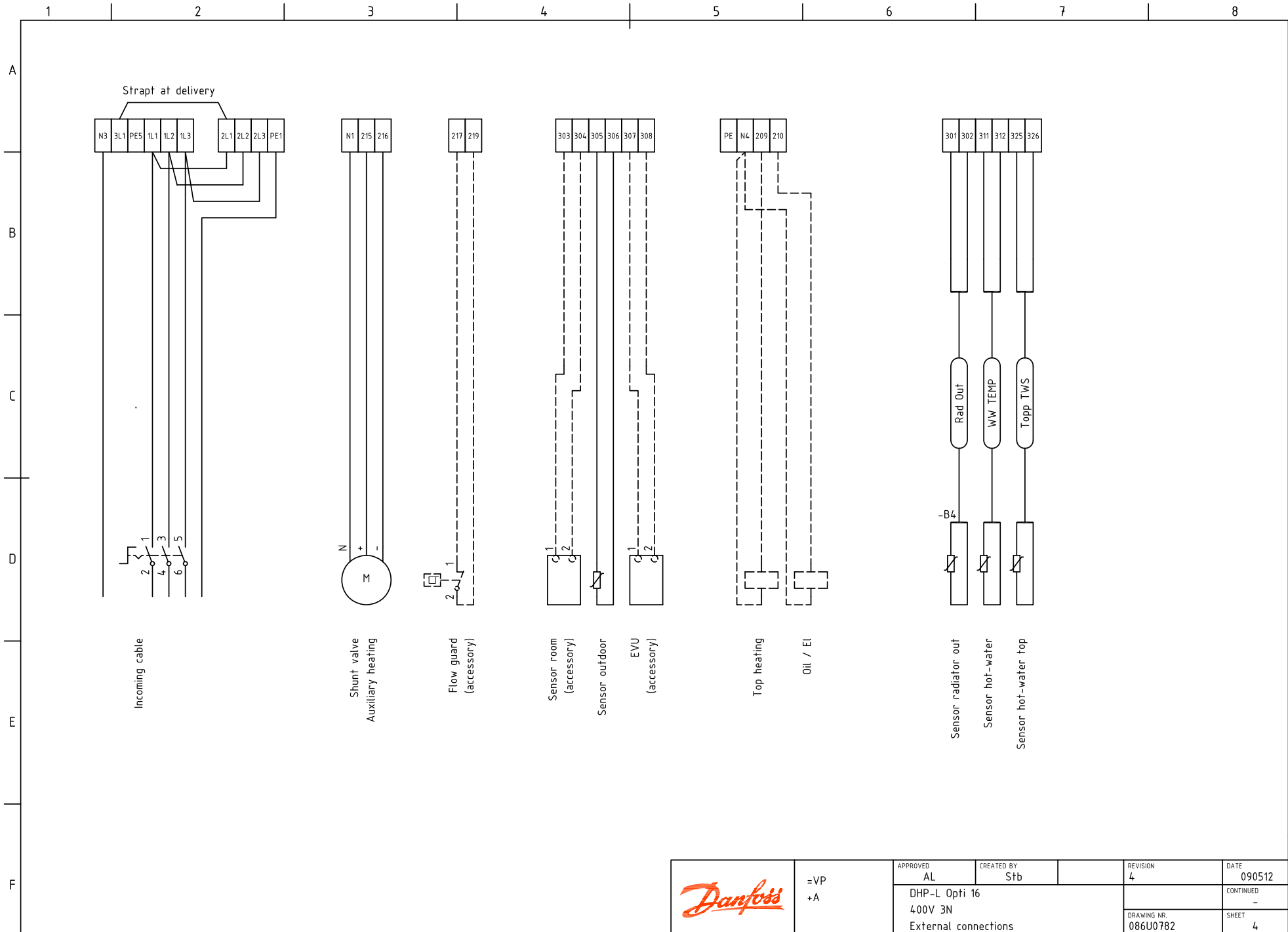

	=VP +A	APPROVED	CREATED BY	REVISION	DATE	
		AL	Sth	4	090512	
		DHP-L Opti 16				CONTINUED
		400V 3N				-
External connections				DRAWING NR.	SHEET	
				086U0782	4	

If these instructions are not followed during installation, operation and maintenance, the obligations of Danfoss under the warranty regulations are no longer binding.

The Danfoss logo is rendered in a bold, black, cursive script font. The letters are fluid and interconnected, with a prominent underline that sweeps across the bottom of the word.

Danfoss A/S
www.danfoss.com