

INSTRUCTIONS MT / MTZ / NTZ COMPRESSORS

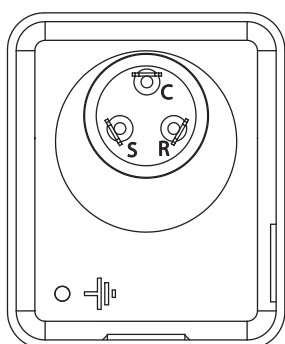
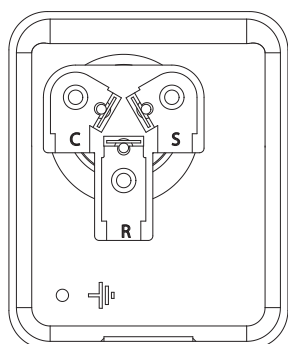
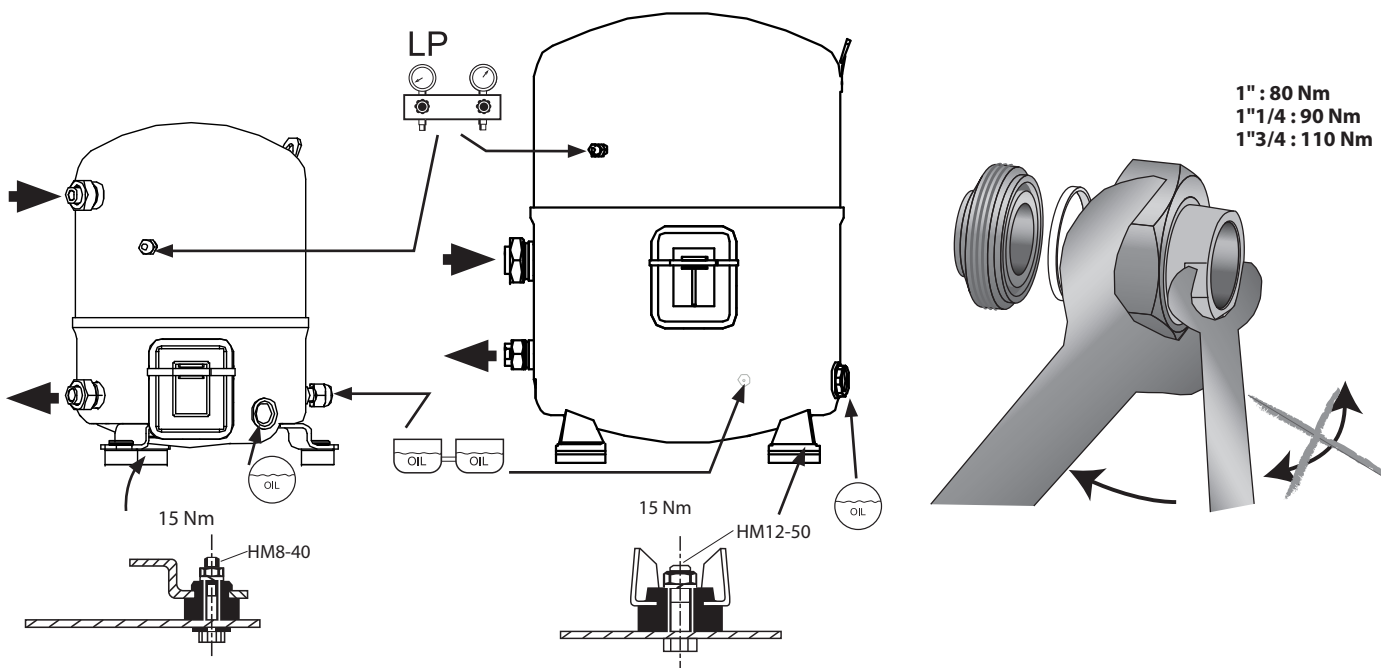

Danfoss Commercial Compressors			MADE IN FRANCE
Model Number	Model no: MTZ28JE6AVE	230V 1-50 Hz	Supply Voltage Maximum current Starting current
Serial Number	Serial no: TJ 10 1010101	20 A Max LR 51 A	
Housing Service Pressure	PS 22.6 bar TS Max 50 °C LP side TS Min -35 °C	CE	THERMALLY PROTECTED
Lubricant	REFRIGERANT: R134a-R507A-R404A-R407C LUBRICANT: P.O.E. 160 PZ 2007		

⚠ Never operate compressors without terminal cover fitted

1~ PSC

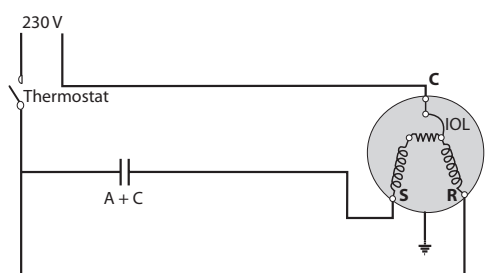

1~ CSR

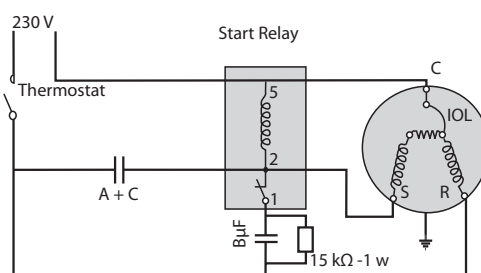

3~

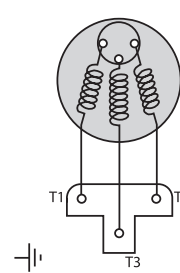

Operating limits		MT	MTZ	MTZ	MTZ	NTZ
		R22	R407C	R134a	R404A / R507A	
High side pressure range	bar (g)	10,9 - 27,7	12,5 - 29,4	7,9 - 22,6	13,2 - 27,7	13,2 - 27,7
Low side pressure range	bar (g)	1,0 - 7,0	1,4 - 6,6	0,6 - 4,7	1,0 - 7,2	0,1 - 3,3

Discharge temperature must be kept lower than 130°C

⚠ Installation and servicing of the compressor by qualified personnel only. Follow these instructions and sound refrigeration engineering practice relating to installation, commissioning, maintenance and service.

<p>⚠ The compressor must only be used for its designed purpose(s) and within its scope of application (refer to «operating limits»). Consult Application guidelines and datasheet available from cc.danfoss.com</p>	<p>The compressor is delivered under nitrogen gas pressure (between 0.3 and 0.7 bar) and hence cannot be connected as is; refer to the «assembly» section for further details.</p>	<p>⚠ Under all circumstances, the EN378 (or other applicable local safety regulation) requirements must be fulfilled.</p>	<p>The compressor must be handled with caution in the vertical position (maximum offset from the vertical: 15°)</p>
---	--	---	---

Instructions

1 - Introduction

These instructions pertain to the Maneurop® MT, MTZ & NTZ compressors used for refrigeration systems. They provide necessary information regarding safety and proper usage of this product.

2 – Handling and storage

- Handle the compressor with care. Use the dedicated handles in the packaging. Use the compressor lifting lug and use appropriate and safe lifting equipment.
- Store and transport the compressor in an upright position.
- Store the compressor between -35°C and 50°C.
- Don't expose the compressor and the packaging to rain or corrosive atmosphere.

3 – Safety measures before assembly

⚠ Never use the compressor in a flammable atmosphere.

- The compressor ambient temperature may not exceed 50°C during off-cycle.
- Mount the compressor on a horizontal flat surface with less than 3° slope.
- Verify that the power supply corresponds to the compressor motor characteristics (see nameplate).
- When installing MTZ or NTZ, use equipment specifically reserved for HFC refrigerants which was never used for CFC refrigerants.
- Use clean and dehydrated refrigeration-grade copper tubes and silver alloy brazing material.
- Use clean and dehydrated system components.
- The piping connected to the compressor must be flexible in 3 dimensions to dampen vibrations.

4 - Assembly

- Slowly release the nitrogen holding charge through the schrader port.
- Remove the gaskets when brazing rotolock connectors.
- Always use new gaskets for assembly.
- Connect the compressor to the system as soon as possible to avoid oil contamination from ambient moisture.
- Avoid material entering into the system while cutting tubes. Never drill holes where burrs cannot be removed.
- Braze with great care using state-of-the-art technique and vent piping with nitrogen gas flow.
- Connect the required safety and control devices. When the schrader port is used for this, remove the internal valve.

5 – Leak detection

⚠ Never pressurize the circuit with oxygen or dry air. This could cause fire or explosion.

- Do not use dye for leak detection.
- Perform a leak detection test on the complete system.
- The low side test pressure must not exceed 25 bar.
- When a leak is discovered, repair the leak and repeat the leak detection.

6 – Vacuum dehydration

- Never use the compressor to evacuate the system.
- Connect a vacuum pump to both the LP & HP sides.
- Evacuate the system to a pressure of 500 µm Hg (0.67 mbar) absolute.
- Do not use a megohmmeter nor apply power

to the compressor while it is under vacuum as this may cause internal damage.

7 – Electrical connections

- Switch off and isolate the main power supply. See overleaf for wiring details.
- The compressor is protected against excess current and temperature by an internal overload protector. Follow local regulations regarding power line protection. The compressor must be connected to earth.
- All electrical components must be selected as per local standards and compressor requirements.

8 – Filling the system

- Keep the compressor switched off.
- Fill the refrigerant in liquid phase into the condenser or liquid receiver. The charge must be as close as possible to the nominal system charge to avoid low pressure operation and excessive superheat.
- Keep the refrigerant charge below 2.5 kg per compressor cylinder if possible. Above this limit; protect the compressor against liquid flood-back with a pump-down cycle or suction line accumulator.
- Never leave the filling cylinder connected to the circuit to avoid overfilling.

9 – Verification before commissioning

⚠ Use safety devices such as safety pressure switch and mechanical relief valve in compliance with both generally and locally applicable regulations and safety standards. Ensure that they are operational and properly set.

⚠ Check that the settings of high-pressure switches and relief valves don't exceed the maximum service pressure of any system component.

- A low-pressure switch is recommended to avoid vacuum operation. Minimum setting 0.1 bar.
- Verify that all electrical connections are properly fastened and in compliance with local regulations.
- When a crankcase heater is required, it must be energized at least 12 hours before initial start-up and start-up after prolonged shutdown.

10 – Start-up

- All service valves must be in the open position.
- Balance the HP/LP pressure.
- Energize the compressor. It must start promptly. If it does not, switch it off immediately. Possible single phase miswiring can cause burn-out within seconds.
- If the compressor does not start, check wiring conformity and voltage on terminals.
- If the internal overload protector trips out, it must cool down to 60°C to reset. Depending on ambient temperature, this may take up to several hours.

11 – Check with running compressor

- Check current draw and voltage.
- Check suction superheat to reduce risk of slugging.
- When a sight glass is provided observe the oil level at start and during operation to confirm that the oil level remains visible.
- Respect the operating limits as printed overleaf.
- Check all tubes for abnormal vibration. Movements in excess of 1.5 mm require corrective measures such as tube brackets.
- When needed, additional refrigerant in the liquid phase may be added in the low-pressure

side as far as possible from the compressor. The compressor must be operating during this process.

- Do not overcharge the system.
- Never release refrigerant to the atmosphere.
- Before leaving the installation site, carry out a general installation inspection regarding cleanliness, noise and leak detection.
- Record type and amount of refrigerant charge as well as operating conditions as a reference for future inspections.

12 - Maintenance

⚠ Internal pressure and surface temperature are dangerous and may cause permanent injury. Maintenance operators and installers require appropriate skills and tools. Tubing temperature may exceed 100°C and can cause severe burns.

⚠ Ensure that periodic service inspections to ensure system reliability and as required by local regulations are performed.

To prevent system related compressor problems, following periodic maintenance is recommended:

- Verify that safety devices are operational and properly set.
- Ensure that the system is leak tight.
- Check the compressor current draw.
- Confirm that the system is operating in a way consistent with previous maintenance records and ambient conditions.
- Check that all electrical connections are still adequately fastened.
- Keep the compressor clean and verify the absence of rust and oxidation on the compressor shell, tubes and electrical connections.

13 - Warranty

Always transmit the model number and serial number with any claim filed regarding this product.

The product warranty may be void in following cases:

- Absence of nameplate.
- External modifications; in particular, drilling, welding, broken feet and shock marks.
- Compressor opened or returned unsealed.
- Rust, water or leak detection dye inside the compressor.
- Use of a refrigerant or lubricant not approved by Danfoss.
- Any deviation from recommended instructions pertaining to installation, application or maintenance.
- Use in mobile applications.
- Use in explosive atmospheric environment.
- No model number or serial number transmitted with the warranty claim.

14 – Disposal

 Danfoss recommends that compressors and compressor oil should be recycled by a suitable company.