



**Controller for operation of
evaporator on water chiller
EKC 316A**

Contents

Introduction	2
Operation	3
Survey of functions.....	4
Operation	8

Menu survey.....	8
Data	10
Connections	10
Ordering	10

Introduction

Application

The controller and valve can be used where there are requirements to accurate control of superheat and temperature in connection with refrigeration.

E.g.:

- Processing plant (water chillers)
- Cold store (air coolers)
- A/C plant

Advantages

- The evaporator is charged optimally – even when there are great variations of load and suction pressure.
- Energy savings – the adaptive regulation of the refrigerant injection ensures optimum utilisation of the evaporator and hence a high suction pressure.
- The superheating is regulated to the lowest possible value at the same time as the media temperature is controlled by the thermostat function.

Functions

- Regulation of superheat
- Temperature control
- MOP function
- ON/OFF input for start/stop of regulation
- Input signal that can displace the superheat reference or the temperature reference
- Alarm if the set alarm limits are exceeded
- Relay output for solenoid valve
- PID regulation

System

The superheat in the evaporator is controlled by one pressure transmitter P and one temperature sensor S2.
The expansion valve is with step motor of the type ETS.

If temperature control is required, this can be accomplished via a signal from temperature sensor S3 placed in the air flow before the evaporator. The temperature control is an ON/OFF thermostat that opens for the liquid flow when refrigeration is required – the ETS valve opens and the thermostat relay cuts in.

For safety reasons the liquid flow to the evaporator must be cut off if there is power failure for the controller. As the ETS valve is provided with step motor, it will remain open in such a situation.

- There are two ways of coping with this situation:
- Mounting of a solenoid valve in the liquid line
 - Mounting of battery backup for the valve

Superheat regulation

Shown on page 12 are the different forms of regulation algorithms which the controller can be set for.

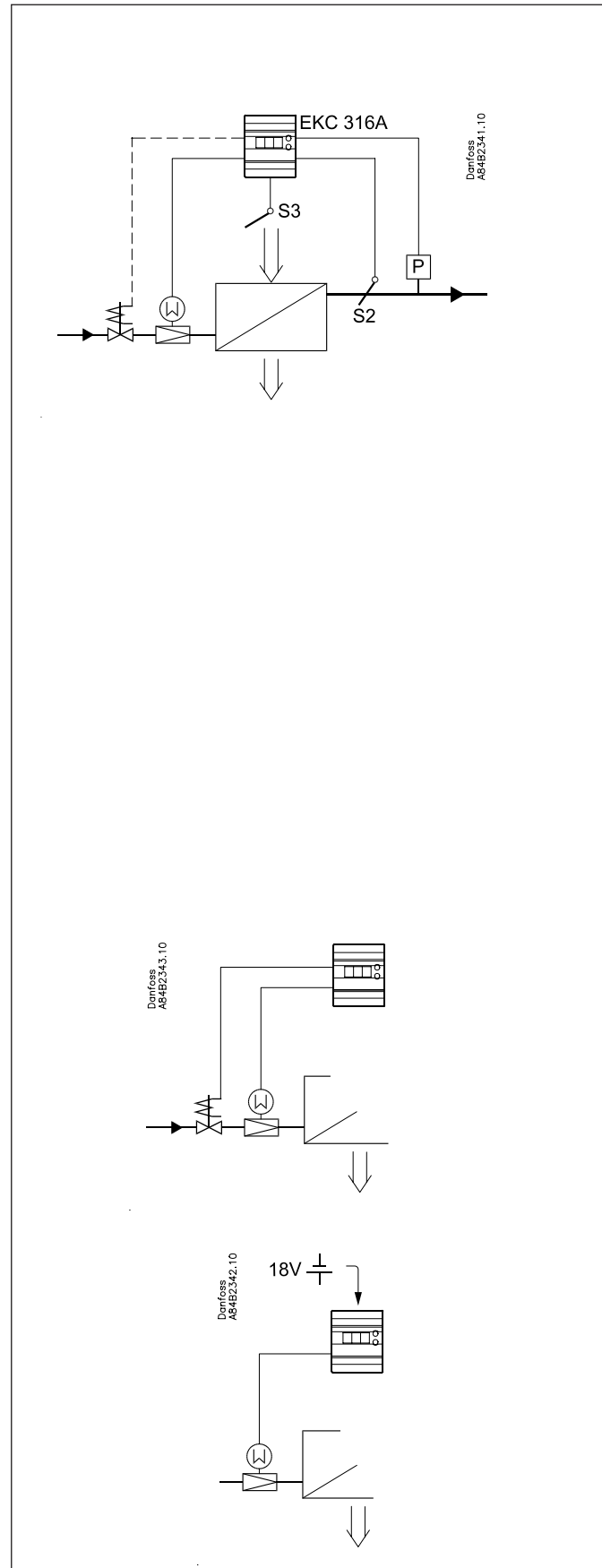

Operation

Superheat function

You may choose between two kinds of superheat, either:

- Adaptive superheat or
- Load-defined superheat

MOP

The MOP function limits the valve's opening degree as long as the evaporating pressure is higher than the set MOP value.

Override function

Via the analog input a displacement can be made of the temperature reference or of the superheat reference. The signal can either be a 0-20 mA signal or a 4-20 mA signal. The reference can be displaced in positive or negative direction.

The signal can be used to override the valve's opening degree.

External start/stop of regulation

The controller can be started and stopped externally via a contact function connected to input terminals 1 and 2. Regulation is stopped when the connection is interrupted. The function must be used when the compressor is stopped. The controller then closes the solenoid valve so that the evaporator is not charged with refrigerant.

Relays

The relay for the solenoid valve will operate when refrigeration is required. The relay for the alarm function works in such a way that the contact is cut in in alarm situations and when the controller is de-energised.

PC operation

The controller can be provided with data communication so that it can be connected to other products in the range of ADAP-KOOL® refrigeration controls. In this way operation, monitoring and data collection can be performed from one PC – either on the spot or in a service company.

See also page 14.

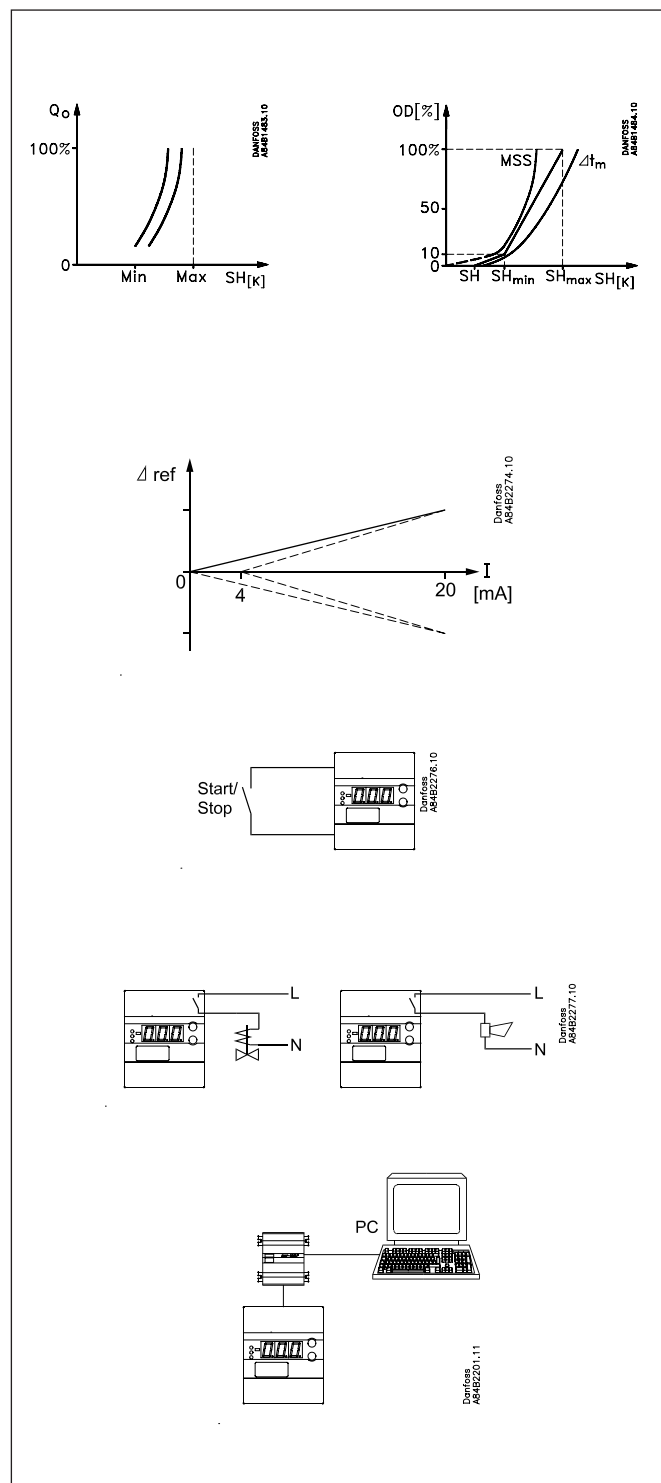

Survey of functions

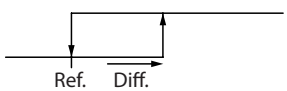
Function	Parameter	Parameter by operation via data communication
Normal display		
Normally the superheat is shown (but the valve's opening degree or air temperature may also be selected. See o17).		SH / OD% / S3 temp
Reference		Thermostat control
Set point (set only if r14=1) Regulation is performed based on the set value provided that there is no external contribution (o10). (Push both buttons simultaneously to set the setpoint).	- *	TempSetpoint.
Differential When the temperature is higher than the reference plus the set differential, the solenoid valve's relay will be activated. It will become deactivated when the temperature drops below the set reference. 	r01 *	Differential
Unit Here you select whether the controller is to indicate the temperature values in °C or in °F. And pressure values in bar or psig. If indication in °F is selected, other temperature settings will also change over to Fahrenheit, either as absolute values or as delta values The combination of temperature unit and pressure unit is depicted to the right.	r05	Units (Menu = Misc.) 0: °C + bar 1: °F + psig (in AKM only °C + bar – is displayed – whatever the setting).
External contribution to the reference This setting determines how large a contribution is to be added to the set setpoint when the input signal is max. (20 mA). See o10.	r06	ExtRefOffset
Correction of signal from S2 (Compensation possibility through long sensor cable).	r09	Adjust S2 (Menu = Misc.)
Correction of signal from S3 (Compensation possibility through long sensor cable).	r10	Adjust S3 (Menu = Misc.)
Start/stop of refrigeration With this setting refrigeration can be started and stopped. Start/stop of refrigeration can also be accomplished with the external switch function. See also appendix 1.	r12	Main Switch
Define thermostat function 0: No thermostat function. Only the superheat is regulated 1: Thermostat function as well as regulation of superheat.	r14	Therm. Mode
Alarm		Alarm setting
The controller can give alarm in different situations. When there is an alarm all the light-emitting diodes (LED) will flash on the controller front panel, and the alarm relay will cut in.		
Alarm for upper deviation The alarm for too high S3 temperature is set here. The value is set in Kelvin. The alarm becomes active when the S3 temperature exceeds the actual reference plus A01. (The actual reference can be seen in u28).	A01 *	Upp.TempAlrm
Alarm for lower deviation The alarm for too low S3 temperature is set here. The value is set in Kelvin. The alarm becomes active when the S3 temperature drops below the actual reference minus A02.	A02 *	Low.TempAlrm
Alarm delay If one of the two limit values is exceeded, a timer function will commence. The alarm will not become active until the set time delay has been passed. The time delay is set in minutes.	A03 *	TempAlrmDel
Battery alarm Here it is defined whether the controller is to monitor the voltage from the battery backup. If there is low voltage or no voltage alarm will be given.	A34	Batt. alarm

*) Only used if thermostat function (r14 = 1) is also to be selected.

		With data communication the importance of the individual alarms can be defined. Setting is carried out in the "Alarm destinations" menu. See also page 14
Control parameters		Injection control
P: Amplification factor Kp If the Kp value is reduced the regulation becomes slower.	n04	Kp factor
I: Integration time Tn If the Tn value is increased the regulation becomes slower.	n05	Tn sec.
D: Differentiation time Td The D-setting can be cancelled by setting the value to min. (0).	n06	Td sec.
Max. value for the superheat reference	n09	Max SH
Min. value for the superheat reference Warning! Due to the risk of liquid flow the setting should not be lower than approx. 2-4 K.	n10	Min SH
MOP If no MOP function is required, select pos. Off.	n11	MOP (bar) (A value on max (60) corresponds to Off)
Start-up time for safety signal If the controller does not obtain a reliable signal within this period of time the controller will in other ways try to establish a stable signal. (A too high value may result in a flooded evaporator). The value should only be changed by specially trained staff.	n15	StartUp time
Signal safety during start-up The control function uses the value as start value for the valve's opening degree at each thermostat cutin. By adaptive control the controller continuously calculates a new value. The value should only be changed by specially trained staff.	n17	Start OD%
Stability factor for regulation of superheat With a higher value the control function will allow a greater fluctuation of the superheat before the reference is changed. The value should only be changed by specially trained staff.	n18	Stability
Damping of amplification near reference value This setting damps the normal amplification Kp, but only just around the reference value. A setting of 0.5 will reduce the KP value by half. The value should only be changed by specially trained staff.	n19	Kp Min
Amplification factor for the superheat This setting determines the valve's opening degree as a function of the change in evaporating pressure. An increase of the evaporating pressure will result in a reduced opening degree. When there is a drop-out on the low-pressure thermostat during start-up the value must be raised a bit. If there is pending during start-up the value must be reduced a little. The value should only be changed by specially trained staff.	n20	Kp T0
Definition of superheat regulation (Ref. appendix 3) 1: Lowest permissible superheat (MSS). Adaptive regulation. 2: Load-defined superheat. The reference is established based on the line formed by the three points: n09, n10 and n22.	n21	SH mode
Value of min. superheat reference for loads under 10% (The value must be smaller than "n10").	n22	SH Close
Max. opening degree (AKV only) The valve's opening degree can be limited. The value is set in %	n32	ETS OD% Max (Menu=Danfoss only)
The parameters "n37" to "n42" are settings for step motor ETS 50. The settings in n37 must be changed when another valve is used. The other settings should not be changed.		
Number of steps from 0% to 100% open	n37	Max. steps (0 - 5000 step)
Spindle stroke speed (number of steps per second)	n38	Steps / sec (10 - 300 step/sec)
Compensation value for spindle play at valve's closing point (number of steps)	n39	Start bcklsh (Menu=Danfoss only)
Compensation value for spindle play during operation (number of steps)	n40	Backlash (Menu=Danfoss only)
Valve definition 1=Valve must open when more capacity is required (NC function) 2=Valve must close when more capacity is required (NO function)	n41	Valve type (Menu=Danfoss only)
Compensation direction 1=Compensation takes place when the valve opens (normal setting) 2=Compensation takes place when the valve closes	n42	Comp.dir. (Menu=Danfoss only)
Attenuation factor for the inner loop gain Used only when o56 = 2 or 3. The value should only be changed by specially trained staff.	n43	Atten. factor

Integration time for the inner loop gain Used only when o56 = 2 or 3. The value should only be changed by specially trained staff.	n44	TnT0 sec
Safety value for the lower temperature reference Used only when o56 = 3. The value should only be changed by specially trained staff.	n45	Min.Lim.Ref.
Miscellaneous		Miscellaneous
Address If the controller is built into a network with data communication, it must have an address, and the master gateway of the data communication must then know this address. These settings can only be made when a data communication module has been mounted in the controller and the installation of the data communication cable has been completed. This installation is mentioned in a separate document "RC8AC"		Following installation of a data communication module, the controller can be operated on a par with the other controllers in ADAP-KOOL® refrigeration controls.
The address is set between 0 and 119	o03	-
The address is sent to the gateway when the menu is set in pos. ON (The setting will automatically change back to Off after a few seconds.)	o04	-
Input signal for reference displacement Definition of function and signal range. 0: No signal 1: Displacement of temperature reference with 0-20 mA 2: Displacement of temperature reference with 4-20 mA 3: Displacement of superheat reference with 0-20 mA 4: Displacement of superheat reference with 4-20 mA (1-4 or 0 mA will not give a displacement. 20 mA will displace the reference by the value set in menu r06) 5: Forced control of valves max. opening degree with 0-20 mA 6: Forced control of valves max. opening degree with 4-20 mA (5-6: 4 or 0 mA will force close the valve. 20 mA will allow 100% opening degree. With a current signal which is less than the 20 mA the opening degree will be limited so the PI regulations opening degree not will exceed this value.)	o10	AI A type
Frequency Set the net frequency.	o12	50 / 60 Hz (50=0, 60=1)
Select signal for showing display Here you can select the signal to be shown in the normal display. 1: Superheat 2: Valve's opening degree 3: Air temperature (If you during operation give the lower button a brief push, you can see the following: The S3 temperature, if 1 has been selected. The superheat reference, if 2 has been selected. Temperature reference if 3 has been selected)	o17	Display mode
Manual control of outputs For service purposes the individual relay outputs and the ETS-output can be forced However only when regulation has been stopped. OFF: No override 1: Relay to the solenoid valve is ON. 2: Relay to the solenoid valve is OFF 3: Alarm relay is activated (connection established between terminals 12 and 13). 4: Forced control of valve opening degree with 0-20 mA signal (0=closed, 20 open) 5: Forced control of valve opening degree with 4-20 mA signal (4=closed, 20 open) At "4" and "5" relays for solenoid valve and alarm relays are off. In settings 1-3, "o45" will become active and the ETS output can be set manually.	o18	Manual ctrl
Manual control of the ETS valve When "o18" is activated (1-3) the valve's opening degree can be determined from this menu.	o45	Manual ETS OD%
Working range for pressure transmitter Depending on the application a pressure transmitter with a given working range is used. This working range (say, -1 to 12 bar) must be set in the controller. The min. value is set.	o20	MinTransPres.
The max. value is set	o21	MaxTransPres.
Selection of control mode Depending on the application control can be carried out based on different parameters. The three possibilities are shown in appendix 4. 1=normal control 2=with inner loop regulation and T0 3=with inner loop regulation and S4 temperature less T0	o56	Reg. type

Refrigerant setting Before refrigeration can be started, the refrigerant must be defined. You can select the following refrigerants: 1=R12. 2=R22. 3=R134a. 4=R502. 5=R717. 6=R13. 7=R13b1. 8=R23. 9=R500. 10=R503. 11=R114. 12=R142b. 13=User defined. 14=R32. 15=R227. 16=R401A. 17=R507. 18=R402A. 19=R404A. 20=R407C. 21=R407A. 22=R407B. 23=R410A. 24=R170. 25=R290. 26=R600. 27=R600a. 28=R744. 29=R1270. (Warning: Wrong selection of refrigerant may cause damage to the compressor).	o30	Refrigerant
Service		
A number of controller values can be printed for use in a service situation		
Read value of external current signal (AIA)	u06	AI A mA
Read status of input DI (start/stop input)	u10	DI
Read the ongoing cutin time for the thermostat or the duration of the last completed cutin	u18	Ther. RunTime
Read the temperature at the S2 sensor	u20	S2 temp.
Read superheat	u21	SH
Read the control's actual superheat reference	u22	SH ref.
Read the valve's opening degree	u24	OD%
Read evaporating pressure	u25	Evap. pres. Pe
Read evaporating temperature	u26	Evap.Press.Te
Read the temperature at the S3 sensor	u27	S3 temp.
Read control reference (Set setpoint + any contribution from external signal)	u28	Temp ref.
Read value of current signal from pressure transmitter (AIB)	u29	AI B mA
	--	DO1 Alarm Read status of alarm relay
	--	DO2 Liq. Valv Read status of relay for solenoid valve
Operating status		
The controller's operating status can be called forth by a brief (1s) activation of the upper button. If a status code exists it will be shown. (Status codes have lower priority than alarm codes. This means that status codes cannot be seen if there is an active alarm code. The individual status codes have the following meanings:		EKC State (0 = regulation)
S10: Refrigeration stopped by the internal or external start/ stop.		10
S11: Thermostat is cutout		11

Configuration settings (n37, n38, o56 and o30) only available when regulation is stopped (r12 = off).

Operation

Display

The values will be shown with three digits, and with a setting you can determine whether the temperature are to be shown in °C or in °F. (Pressure in bar or psig.)

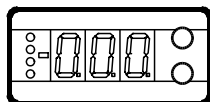

Light-emitting diodes (LED) on front panel

There are LED's on the front panel which will light up when the belonging relay is activated.

The uppermost LED will indicate when the valve is moving towards a greater opening degree.

The next LED will indicate when the valve is moving towards a smaller opening degree.

The third one will indicate when the thermostat demands refrigeration.

All light-emitting diodes will flash when there is an error in the regulation.

In this situation you can upload the error code on the display and cancel the alarm by giving the uppermost button a brief push.

The buttons

When you want to change a setting, the two buttons will give you a higher or lower value depending on the button you are pushing. But before you change the value, you must have access to the menu. You obtain this by pushing the upper button for a couple of seconds - you will then enter the column with parameter codes. Find the parameter code you want to change and push the two buttons simultaneously. When you have changed the value, save the new value by once more pushing the two buttons simultaneously.



○ Gives access to the menu (or cutout an alarm)

○ Gives access to changes

○ Saves a change

Examples of operations

Set set-point for the thermostat

1. Push the two buttons simultaneously
2. Push one of the buttons and select the new value
3. Push both buttons again to conclude the setting

Set one of the other menus

1. Push the upper button until a parameter is shown
2. Push one of the buttons and find the parameter you want to change
3. Push both buttons simultaneously until the parameter value is shown
4. Push one of the buttons and select the new value
5. Push both buttons again to conclude the setting

Menu survey

SW =1.2x

Function	Parameter	Min.	Max.	Fac. sett.
Normal display				
Shows the actual superheat/ valve's opening degree/ temperature Define view in o17	-		K	
If you wish to see the expansion valve's actual opening degree, give the lower button a brief push (1s). Define view in o17	-		%	
Reference				
Set the required set point for the thermostat	- *	-60°C	50°C	3.0
Differential	r01 *	0.1 K	20.0 K	2.0
Units (0=°C+bar /1=°F+psig)	r05	0	1	0
External contribution to the reference	r06	-50 K	50 K	0..0
Correction of signal from S2	r09	-10.0 K	10.0 K	0.0
Correction of signal from S3	r10	-10.0 K	10.0 K	0.0
Start / stop of refrigeration	r12	OFF	On	On
Define thermostat function (0= no thermostat function, 1=On/off thermostat)	r14	0	1	0
Alarm				
Upper deviation (above the temperature setting)	A01 *	3 K	20 K	5
Lower deviation (below the temperature setting)	A02 *	1 K	10 K	3
Alarm's time delay	A03 *	0 min.	90 min.	30
Battery monitoring	A34	Off	On	Off
Regulating parameters				
P: Amplification factor Kp	n04	0.5	20	3.0
I: Integration time T	n05	30 s	600 s	120
D: Differentiation time Td (0 = off)	n06	0 s	90 s	0
Max. value of superheat reference	n09	2 K	30 K	10
Min. value of superheat reference	n10	1 K	12 K	4
MOP (max = off)	n11	0.0 bar	60 bar	20
Signal reliability during start-up. Safety time period. Should only be changed by trained staff	n15	0 s	90 s	0
Signal reliability during start-up – Opening degree's start value. Should only be changed by trained staff.	n17	0	100	0
Stability factor for superheat control. Changes should only be made by trained staff	n18	0	10	5
Damping of amplification around reference value Changes should only be made by trained staff	n19	0.2	1.0	0.3
Amplification factor for superheat Changes should only be made by trained staff	n20	0.0	10.0	0.4
Definition of superheat control 1=MSS, 2=LOADAP	n21	1	2	1
Value of min. superheat reference for loads under 10%	n22	1 K	15 K	2
Max. opening degree Changes should only be made by trained staff	n32	0 %	100 %	100
<i>"n37" to "n42" are adapted to valve type ETS 50 and should only be changed through the use of another valve.</i>				
Number of steps from 0-100% opening degree (x10) (ETS 50 = 263. ETS 100 = 353)	n37	000 stp**	5000 stp**	263
Number of steps per second	n38	10 stp/s	300 stp/s	250
Compensation of spindle play at the valve's closing point	n39	0 stp	100 stp	50

*) Used only when thermostat function (r14 = 1) is selected.

**) The display on the controller can show 3 digits only, but the setting value has 4 digits. Only the 3 most important will be shown. It means fx. 250 will give a setting of 2500.

Compensation of spindle play in the control range	n40	0 stp	100 stp	100
Valve status when power supply interrupted: 1 = NC, 2 = NO (special application)	n41	1	2	1
Compensation of spindle play at the closing point must take place: 1=when the valve opens, 2=when the valve closes	n42	1	2 stp	1
Attenuation factor for inner loop	n43	0,1	1	0.4
Integration time for inner loop (TnT0)	n44	10 s	120 s	30
Safety value for lower temperature difference for inner loop	n45	1 K	20 K	3.0
Miscellaneous				
Controller's address	o03***	0	119	0
ON/OFF switch (service-pin message)	o04***	-	-	-
Define input signal on the analogue input AIA: 0: no signal, 1: Temperature setpoint. 0-20 mA 2: Temperature setpoint. 4-20 mA 3: Displacement of superheat reference. 0-20 mA 4: Displacement of superheat reference. 4-20 mA 5: Forced control of valve's max. opening degree. 0-20 mA 6: Forced control of valve's max. opening degree 4-20 mA	o10	0	6	0
Set supply voltage frequency	o12	50 Hz	60 Hz	50
Select display for "normal picture" 1: Superheat 2: Valve's opening degree 3: Air temperature	o17	1	3	1
Manual control of outputs: OFF: no manual control 1: Relay for solenoid valve: select ON 2: Relay for solenoid valve: select OFF 3: Alarm relay activated (cut out) 4: Forced control of valve's opening degree. 0-20 mA 5: Forced control of valve's opening degree 4-20 mA At settings 1-3, "o45" will be active	o18	off	5	0
Working range for pressure transmitter – min. value	o20	-1 bar	60 bar	-1.0
Working range for pressure transmitter – max. value	o21	-1 bar	60 bar	12.0
Refrigerant setting 1=R12. 2=R22. 3=R134a. 4=R502. 5=R717. 6=R13. 7=R13b1. 8=R23. 9=R500. 10=R503. 11=R114. 12=R142b. 13=User defined. 14=R32. 15=R227. 16=R401A. 17=R507. 18=R402A. 19=R404A. 20=R407C. 21=R407A. 22=R407B. 23=R410A. 24=R170. 25=R290. 26=R600. 27=R600a. 28=R744. 29=R1270.	o30	0	29	0
Manual control of the valve's opening degree. The function can only be operated if "o18" has been set.	o45	0 %	100 %	0
Selection of control mode: 1=Normal 2 = With inner loop (T0) 3 = With inner loop (S media temperature less T0)	o56	1	3	1

Service

Analog input AIA (16-17)	u06	mA
Read status of input DI	u10	on/off
Thermostat cut-in time	u18	min.
Temperature at S2 sensor	u20	°C
Superheat	u21	K
Superheat reference	u22	K
Read AKV valve's opening degree	u24	%
Read evaporating pressure	u25	bar
Read evaporating temperature	u26	°C
Temperature at S3 sensor	u27	°C
Temperature reference	u28	°C
Read signal at pressure transmitter input	u29	mA

***) This setting will only be possible if a data communication module has been installed in the controller.
Configuration settings available only when regulation is stopped.

The controller can give the following messages:

E1	Error message	Fault in controller
E15		Cut-out S2 sensor
E16		Shortcircuited S2 sensor
E17		Cut-out S3 sensor
E18		Shortcircuited S3 sensor
E19		The input signal on terminals 16-17 is outside the range.
E20		The input signal on terminals 14-15 is outside the range (P0 signal)
A1	Alarm message	High-temperature alarm
A2		Low-temperature alarm
A11		No refrigerant has been selected
A43		Check the supply voltage to the step motor
A44		Battery alarm (no voltage or too low voltage)

Factory setting

If you need to return to the factory-set values, it can be done in this way:

- Cut out the supply voltage to the controller
- Keep both buttons depressed at the same time as you reconnect the supply voltage

Data

Supply voltage	24 V a.c. +/-15% 50/60 Hz, 10 VA (the supply voltage is galvanically separated from the input and output signals)	
Power consumption	Controller	5 VA
	ETS step motor	1,3 VA
Input signal	Current signal	4-20 mA or 0-20 mA
	Pressure transmitter	4-20 mA from AKS 33
	Digital input from external contact function	
Sensor input	2 pcs. Pt 1000 ohm	
Thermostat relay	1 pcs. SPST	AC-1: 4 A (ohmic)
Alarm relay	1 pcs. SPST	AC-15: 3 A (inductive)
Step motor output	Pulsating 100 mA	
Data communication	Possible to connect a data communication module	
Environments	0 to +55°C, during operations	
	-40 to +70°C, during transport	
	20 - 80% Rh, not condensed	
	No shock influence / vibrations	
Enclosure	IP 20	
Weight	300 g	
Mounting	DIN rail	
Display	LED, 3 digits	
Approvals	EU Low Voltage Directive and EMC demands re CE-marking complied with. LVD-tested acc. to EN 60730-1 and EN 60730-2-9 EMC-tested acc. to EN50081-1 and EN 50082-2	

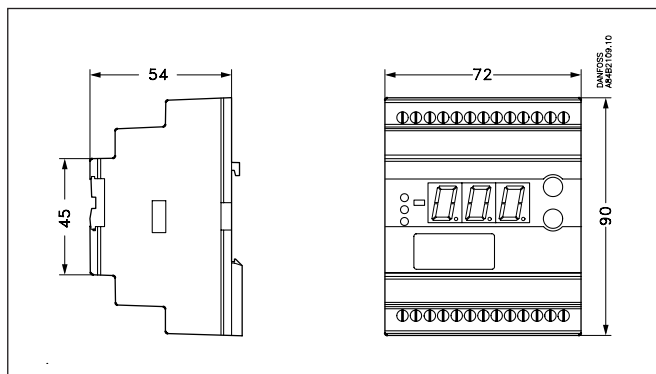

Ordering

Type	Function	Code no.
EKC 316A	Superheat controller	084B7088
EKA 173	Data communication module (accessories), (FTT 10 module)	084B7092
EKA 175	Data communication module (accessories), (RS 485 module)	084B7093
EKA 174	Data communication module (accessories), (RS 485 module) with galvanic separation	084B7124

Temperature sensor Pt 1000 ohm / Pressure transmitter type AKS 33:
Kindly refer to catalogue RK0YG
ETS valves: Kindly refer to data sheet DKRCC.PD-VD1.A1.--

If battery backup is used:

Battery requirements:
18V d.c. min. 100 mAh

Connections

Necessary connections

Terminals:

- 25-26 Supply voltage 24 V a.c.
- 21-24 Supply to step motor
- 18-19 Pt 1000 sensor at evaporator outlet (S2)
- 14-15 Pressure transmitter type AKS 33
- 1-2 Switch function for start/stop of regulation. If a switch is not connected, terminals 1 and 2 must be shortcircuited.
- 5-6 Battery (the voltage will close the ETS valve if the controller loses its supply voltage. The battery connection may however be replaced by installation of a solenoid valve in the liquid line. This will then be connected to terminals 8-9.

IMPORTANT

The 24 Volts a.c. supply to the EKC 316A at terminals 25 and 26 should be completely isolated from the battery supply at terminals 5 and 6, and under no circumstances should these two supplies have common earth.

Application dependent connections

Terminal:

- 18-20 Pt 1000 sensor for measuring air temperature (S3)
- 8-9 Thermostat relay
- 12-13 Alarm relay
There is connection between 12 and 13 in alarm situations and when the controller is dead
- 16-17 Current signal from other regulation (Ext.Ref.)
- 3-4 Data communication
Mount only, if a data communication module has been mounted.

It is important that the installation of the data communication cable be done correctly. Cf. separate literature No. RC8AC...

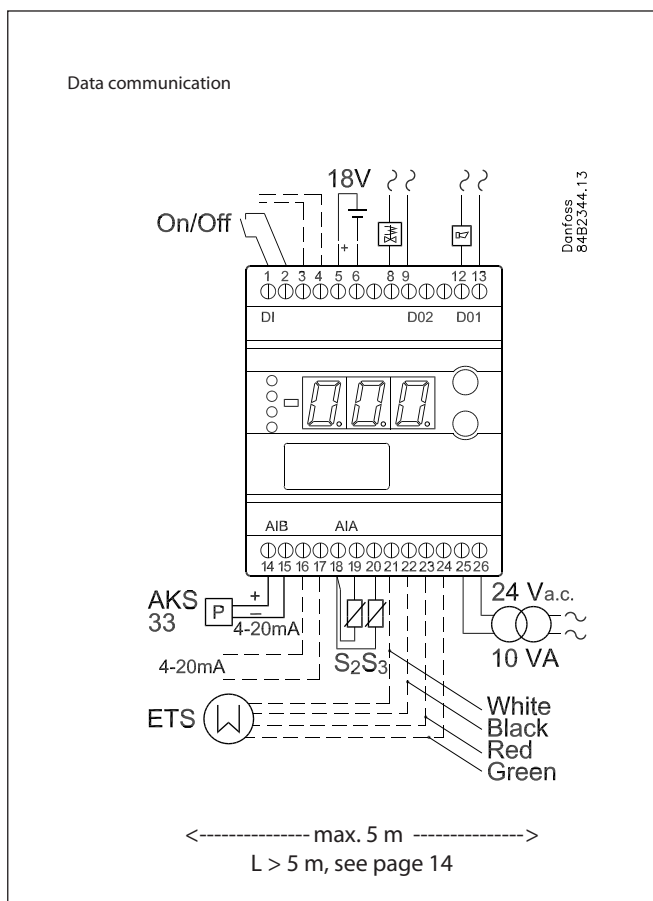

Installation considerations

Accidental damage, poor installation, or site conditions, can give rise to malfunctions of the control system, and ultimately lead to a plant breakdown.

Every possible safeguard is incorporated into our products to prevent this. However, a wrong installation, for example, could still present problems. Electronic controls are no substitute for normal, good engineering practice.

Danfoss will not be responsible for any goods, or plant components, damaged as a result of the above defects. It is the installer's responsibility to check the installation thoroughly, and to fit the necessary safety devices.

Particular attention is drawn to the need for a "force closing" signal to controllers in the event of compressor stoppage, and to the requirement for suction line accumulators.

Your local Danfoss agent will be pleased to assist with further advice, etc.

Appendix 1

Interaction between internal and external start/stop functions and active functions.

Internal Start/stop	Off	Off	On	On
External Start/stop (DI)	Off	On	Off	On
Refrigeration (DO2)	Off		On	
Temperature monitoring	No		Yes	
Sensor monitoring	Yes		Yes	
Set configurations	Yes		No	

Appendix 2

If there are two evaporators sharing the same suction line, the signal from the pressure transmitter can be used by two controllers.

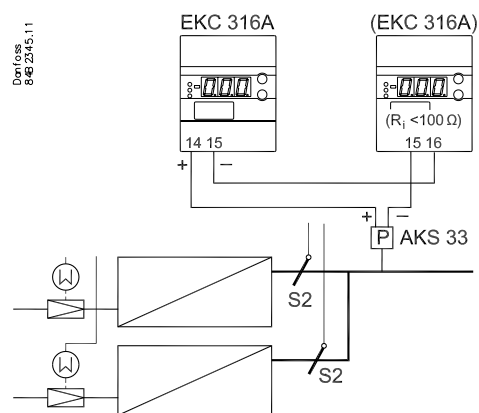

Appendix 3

The two types of regulation for superheat are, as follows:

Adaptive superheat

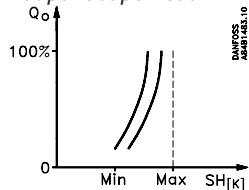

Regulation is here based on the evaporator's load by means of MSS search (MSS = lowest permissible superheat). (The superheat reference is lowered to the exact point where instability sets in). The superheat is limited by the settings for min. and max. superheat.

Load-defined superheat

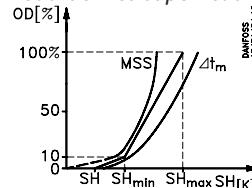

The reference follows a defined curve. This curve is defined by three values: the closing value, the min. value and the max. value. These three values must be selected in such a way that the curve is situated between the MSS curve and the curve for average temperature difference ΔT_m (temperature difference between media temperature and evaporating temperature). Setting example = 4, 6 and 10 K).

Appendix 4

Regulation algorithms for the superheat.

There are several algorithms to choose between. They are set in "o56".

Reg.type = 1

This regulation algorithm is used for the classical method and is recommended for known applications – e.g. for earlier installations with a Danfoss controller. For a start the values for Kp, Tn and Td can be set to values corresponding to the earlier ones.

The thermostat function can also be selected, if required.

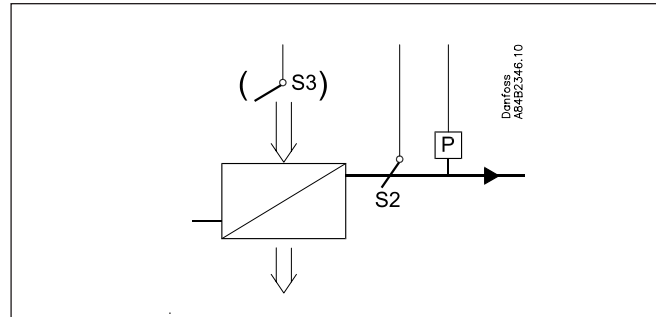

Reg.type = 2

This regulation algorithm is recommended for new installations where the thermostat function is also to be used. The regulation operates with an inner loop which improves the regulation and makes it easier to make optimum settings. The combination of adaptive evaporator and temperature control makes for great temperature accuracy for the refrigerant.

(The algorithm can also be used without thermostat function, if setting "3" with temperature sensor is opted out).

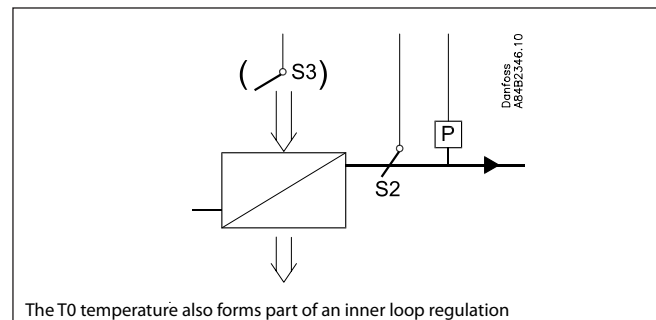

Reg.type = 3

This setting is recommended if only one regulation of the superheat is required.

The regulation algorithm necessitates the mounting of a temperature sensor in the refrigerant, and as there is only one sensor input for the temperature of the refrigerant, the setting cannot be used in combination with the thermostat function. The temperature sensor is connected to input "S3" and mounted in the chilled medium *after* the evaporator. (Danfoss calls a sensor S4 when it is mounted in the refrigerant after the evaporator).

This regulation gives the best superheat regulation of the three mentioned.

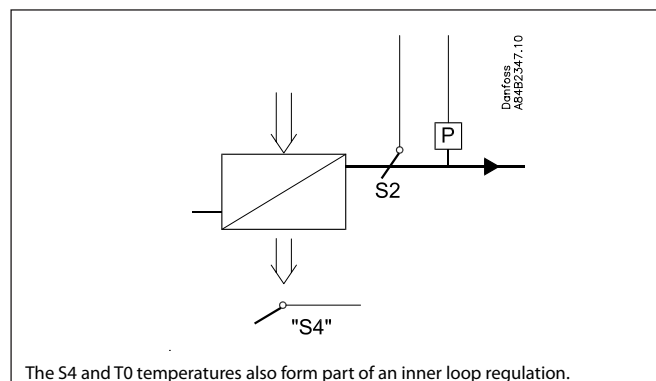

Start of controller

When the electric wires have been connected to the controller, the following points have to be attended to before the regulation starts:

1. Switch off the external ON/OFF switch that starts and stops the regulation.
2. Follow the menu survey on page 8, and set the various parameters to the required values.
3. Switch on the external switch, and regulation will start.
4. Follow the actual room temperature or superheat on the display.

If the superheating fluctuates

When the refrigerating system has been made to work steadily, the controller's factory-set control parameters should in most cases provide a stable and relatively fast regulating system. If the system however fluctuates this may be due to the fact that too low superheat parameters have been selected:

If adaptive superheat has been selected:

Adjust: n09, n10 and n18.

If load-defined superheat has been selected:

Adjust: n09, n10 and n22.

Alternatively it may be due to the fact that the set regulation parameters are not optimal.

If the time of oscillation is longer than the integration time:

($T_p > T_n$, (T_n is, say, 240 seconds))

1. Increase T_n to 1.2 times T_p
2. Wait until the system is in balance again
3. If there is still oscillation, reduce K_p by, say, 20%
4. Wait until the system is in balance
5. If it continues to oscillate, repeat 3 and 4

If the time of oscillation is shorter than the integration time:

($T_p < T_n$, (T_n is, say, 240 seconds))

1. Reduce K_p by, say, 20% of the scale reading
2. Wait until the system is in balance
3. If it continues to oscillate, repeat 1 and 2.

Check that the ETS valve closes when the supply voltage to the controller is interrupted

This control is performed if the controller is connected to battery backup.

The battery will make the step motor move to the end stop and thus close the valve.

The control may be omitted if a solenoid valve is mounted and connected via terminals 9-10.

ETS connection

If the distance between EKC 316A and the ETS valve exceeds 5 m a filter must be mounted to obtain the correct valve function.

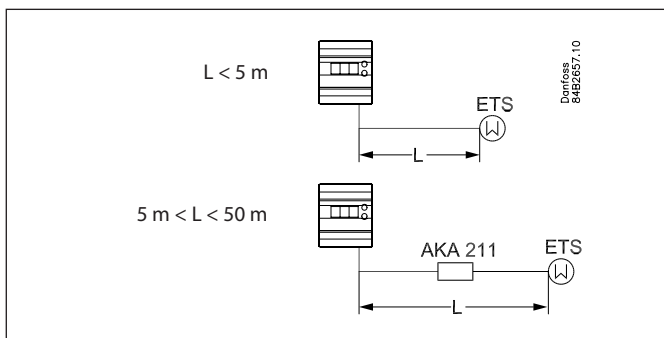

Connection

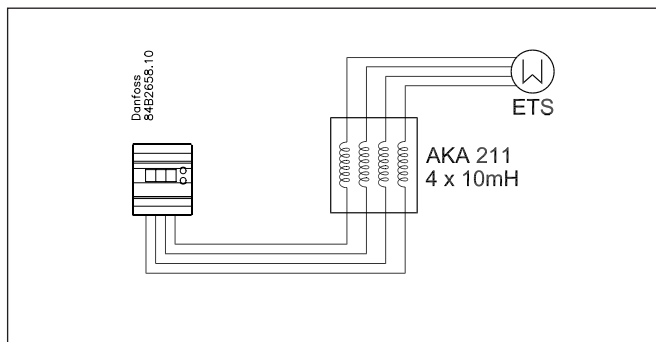

Dimensions

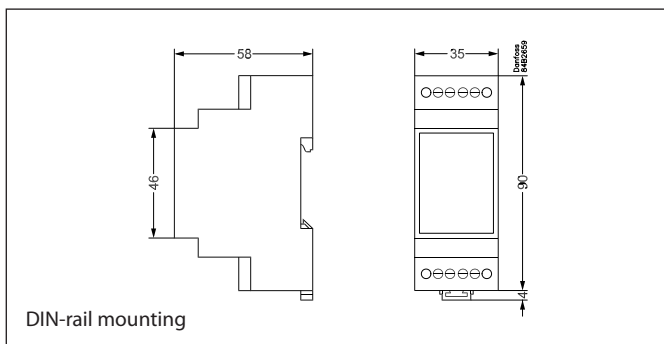

Ordering

Type	Description	Code no.
AKA 211	Filter 4 x 10 mH	084B2238

List of literature

Instructions RI8HA (extract from this manual).

Here you can see how controllers are mounted and programmed.

Installation guide for extended operation RC8AC

Here you can see how a data communication connection to ADAP-KOOL® Refrigeration control systems can be established.