

NMSKE 3/4

Ex-cable gland, brass nickel-plated, NPT 3/4"

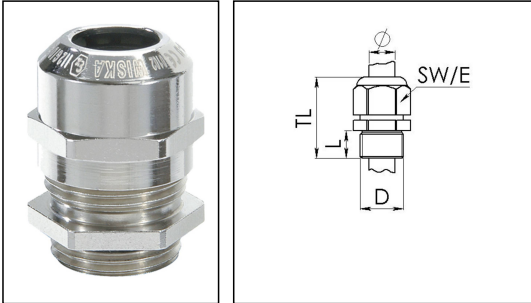

Products may differ in size, colour and appearance to those shown. If you require further information or customisation, please contact us directly.



Material cable gland	Brass nickel-plated
Material clamping cage	Polyamide
Material sealing gasket	EPDM
Temp. range min	-40 °C
Temp. range max	75 °C
Protection class	IP66 / IP68 (5 bar 30 min)
Type of protection	Ex eb, Ex tb
Ex-Certificate	ATEX, IECEx
Thread type	NPT
Ø Connection thread D	3/4"
Length screw-in thread L	16 mm
Ø cable diameter min	10 mm
Ø cable diameter max	17 mm
Key width SW	29 mm
Collar diameter (E)	32 mm
Total length TL	40 mm - 48 mm
Install. torques fitting	10 N m
Install. torques cap nut	10 N m
Surface	Nickel-plated
Order no. nickel-plated	10101085
Type	NMSKE 3/4
Packing unit	50
ETIM-Classification	EC000441

Remarks:

Your Contact:

WISKA Hoppmann GmbH
 Kisdorfer Weg 28 · 24568 Kaltenkirchen · Germany
 ☎ +49-4191-508-0 · 📠 +49-4191-508-209
 contact@wiska.de · www.wiska.com

When using a locknut NMMU, an additional connection thread gasket EADR must be used to achieve protection class IP66 / IP68.

Recommended accessories

RDE 25	10060768
EADR 25	10062804
BS 17	10064012
NMMU 3/4	10100975

30.04.2021

Your Contact:

WISKA Hoppmann GmbH

Kisdorfer Weg 28 · 24568 Kaltenkirchen · Germany

☎ +49-4191-508-0 · 📠 +49-4191-508-209

contact@wiska.de · www.wiska.com



Your Contact:

WISKA Hoppmann GmbH

Kisdorfer Weg 28 · 24568 Kaltenkirchen · Germany

☎ +49-4191-508-0 · 📠 +49-4191-508-209

contact@wiska.de · www.wiska.com