

NMSKE 1 1/4

Ex-cable gland, brass nickel-plated, NPT 1 1/4"

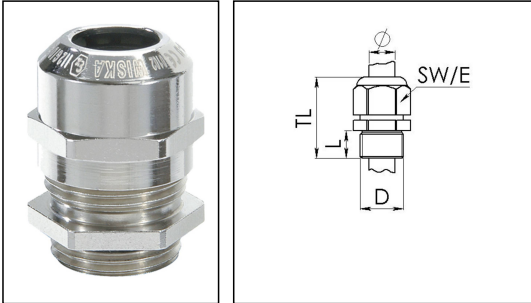

Products may differ in size, colour and appearance to those shown. If you require further information or customisation, please contact us directly.



Material cable gland	Brass nickel-plated
Material clamping cage	Polyamide
Material sealing gasket	EPDM
Temp. range min	-40 °C
Temp. range max	75 °C
Protection class	IP66 / IP68 (5 bar 30 min)
Type of protection	Ex eb, Ex tb
Ex-Certificate	ATEX, IECEx
Thread type	NPT
Ø Connection thread D	1 1/4"
Length screw-in thread L	20 mm
Ø cable diameter min	16 mm
Ø cable diameter max	28 mm
Key width SW	46 mm
Collar diameter (E)	51 mm
Total length TL	50 mm - 58 mm
Install. torques fitting	20 N m
Install. torques cap nut	20 N m
Surface	Nickel-plated
Order no. nickel-plated	10101087
Type	NMSKE 1 1/4
Packing unit	10
ETIM-Classification	EC000441

Remarks:

Your Contact:

WISKA Hoppmann GmbH

Kisdorfer Weg 28 · 24568 Kaltenkirchen · Germany

☎ +49-4191-508-0 · 📠 +49-4191-508-209

contact@wiska.de · www.wiska.com

When using a locknut NMMU, an additional connection thread gasket EADR must be used to achieve protection class IP66 / IP68.

Recommended accessories

RDE 40	10062187
EADR 40	10062806
BS 28	10064016
NMMU 1 1/4	10100977

30.04.2021

Your Contact:

WISKA Hoppmann GmbH

Kisdorfer Weg 28 · 24568 Kaltenkirchen · Germany

☎ +49-4191-508-0 · 📠 +49-4191-508-209

contact@wiska.de · www.wiska.com



Your Contact:

WISKA Hoppmann GmbH

Kisdorfer Weg 28 · 24568 Kaltenkirchen · Germany

☎ +49-4191-508-0 · 📠 +49-4191-508-209

contact@wiska.de · www.wiska.com