

User Guide

Capacity Controller AK-PC 351

ADAP-KOOL® Refrigeration Control System



Introduction

Application

The controller is used for capacity regulation of compressors and condensers in small refrigeration applications. A maximum of 4 compressors and one condenser can be regulated. For example:

- One suction group + one condenser group, max. 6 steps total
- One compressor group, max. 4 steps
- One condenser group, max. 4 steps

Advantages

- Energy savings via:
 - Optimisation of suction pressure
 - Night set back
 - Floating condensing pressure

Input and output

There are a limited number of available inputs and outputs.

For each signal type, though, the following can be connected:

- Analogue inputs, max. 4 pcs.
 - Signal from 2 pressure transmitters and 2 temperature sensors
- Digital inputs, max. 8 pcs.
 - Signal from automatic safety control, external start stop, night signal, general alarm.
- Relay outputs, max. 5 pcs.
 - Connection of compressors, condenser fans, alarm relay
- Solid state outputs, max. 1 pcs.
 - Control of bypass on a digital scroll or for controlling unloader on a stream compressor. If the output is not used for this function, it can be used as ordinary relay output
- Analogue outputs, max. 2 pcs.
 - Speed control of compressors and condenser fans.

Operation

The daily operation can be set up directly on the controller.

During set-up, the display images will be adjusted so that only the relevant images are opened for additional setting and end-user operation.

The operation is password protected, and three levels of access can be granted.

The controller contains several languages. Select the preferred language at start-up.

Data communication

The controller has built-in Modbus data communication, and it can be connected to an AK-SM 800 type system device.

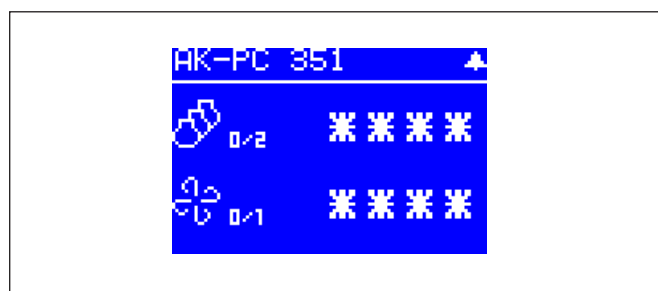
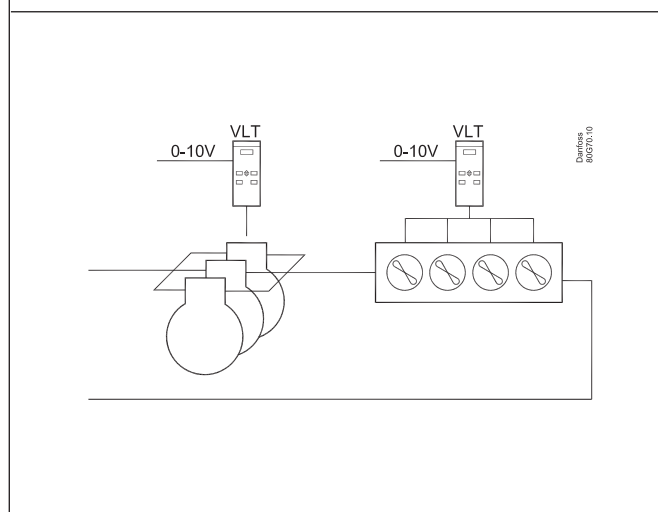
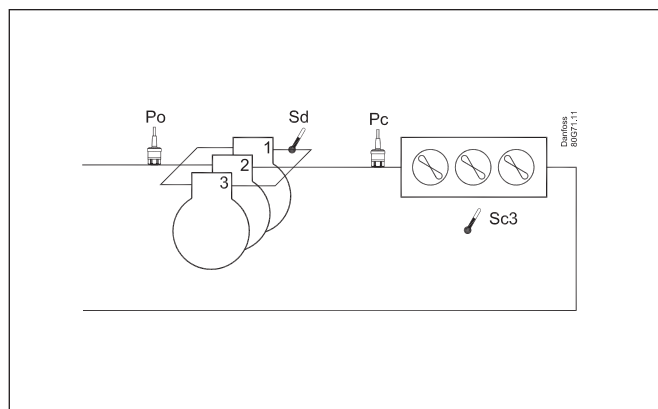

Suction Group

Compressor types

The following types of compressor combinations can be used for regulation:

- Single-step compressors
- Speed controlled compressor together with single-step
- Digital scroll compressor together with single-step
- Stream 4 cylinder compressor together with single-step
- Compressors with an equal number of unloaders.

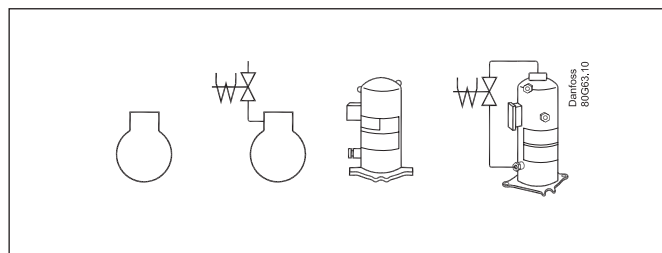

Capacity regulation

The cut-in capacity is controlled by signals from the connected pressure transmitter/temperature sensor and the set reference. Set a neutral zone around the reference.

In the neutral zone the pressure is controlled by the regulating compressor. When it can no longer maintain the pressure within the neutral zone, the controller will cut out or cut in the next compressor in the sequence.

When further capacity is either cut out or cut in, the capacity from the regulating compressor will be modified accordingly to maintain the pressure within the neutral zone (only where the compressor has variable capacity).

- When the pressure is higher than the “reference + a half neutral zone”, cut-in of the next compressor (arrow up) is permitted.
- When the pressure is lower than the “reference - a half neutral zone”, cut-out of a compressor (arrow down) is permitted.
- When the pressure is within the neutral zone, the process will continue with the currently activated compressors.

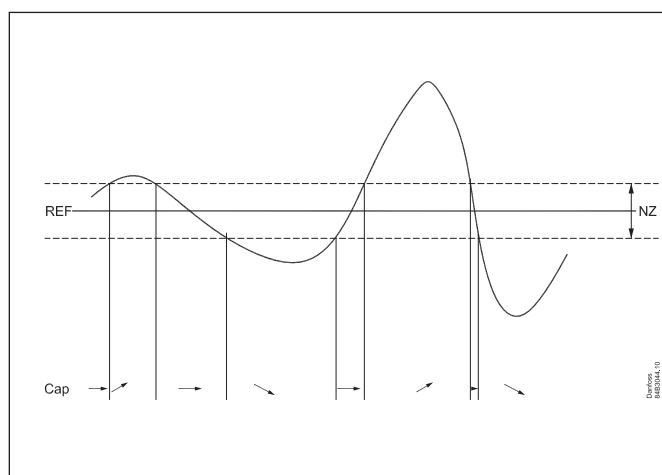

Control sensor

Normally, a suction group is controlled based on a signal from the Po pressure transmitter.

If control on a brine, the S4 sensor must be the control sensor.

An external, low-pressure switch can be connected to DI7 for frost protection.

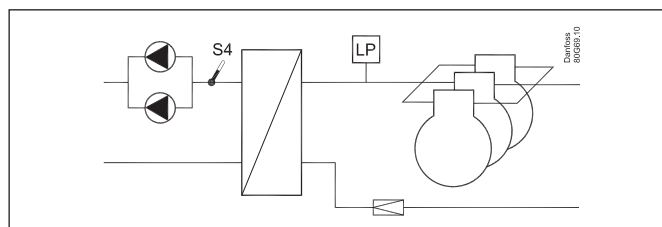

The reference

At set or variable reference can be used for regulation. For example, the variable reference can be used for a night time increase or Po optimisation. Enter a set point here so that a contribution from the Po optimisation or night time increase is added. This contribution can raise or lower the reference, as determined by the momentary cooling need.

To limit the reference from values that are too high or too low, set a max. and min. limit.

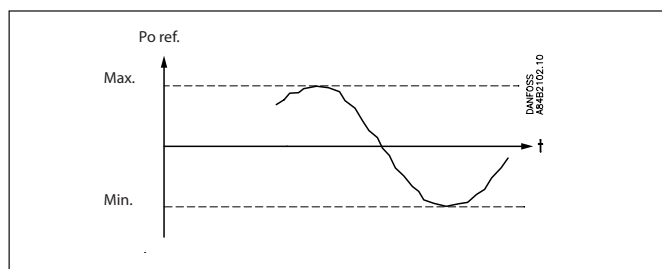

Condenser

Fan control

The fans can be controlled incrementally using the controller's relays, or they can be speed-controlled via the controller's analogue output.

Speed control can be via a frequency VLT-type transformer. If the fans have EC motors, the 0-10 V signal can be used directly.

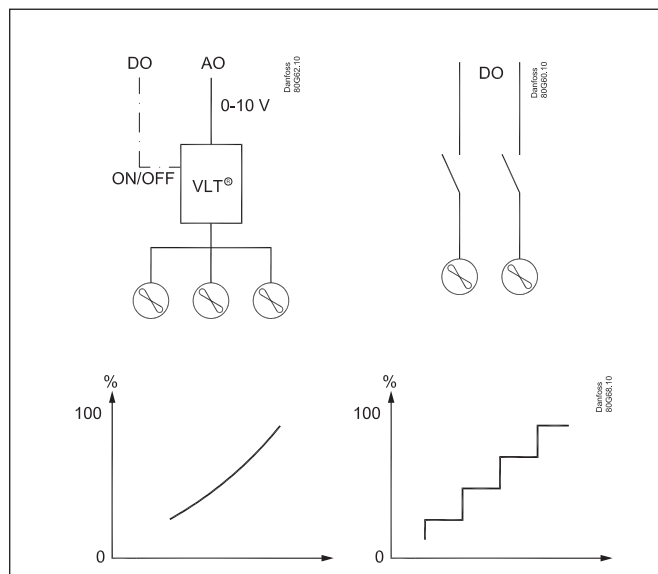

Control

Regulation is carried out based on a signal from the Pc pressure transmitter or an S7 media temperature sensor. The signal is compared with the regulation reference.

The regulation reference can originate from one or more of the following functions:

- Fixed reference
- Variable reference, which follows the outdoor temperature. When the outdoor temperature drops, the reference will drop by a corresponding amount.

This variable reference requires the installation of an Sc3 outdoor temperature sensor. The sensor must be positioned so that it registers the correct outdoor temperature. In other words, it must be shielded from direct sunlight and located near the airway of the condenser.

This regulation requires setting a min. and max. reference, so that the regulation process is kept within the given limits.

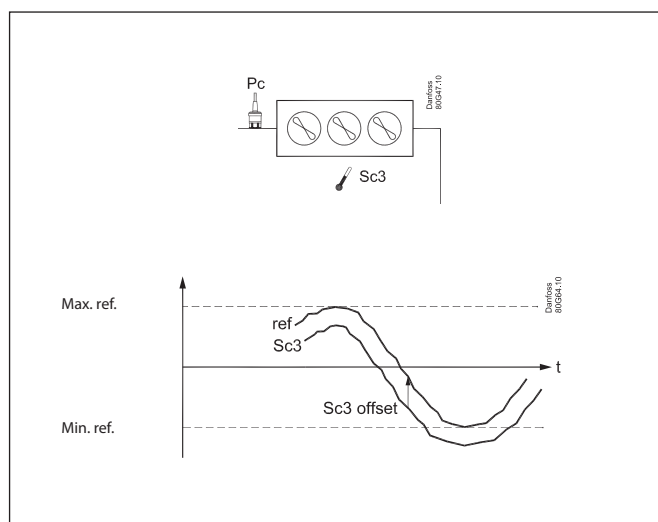

Media temperature

If controlling a media temperature, the control sensor must be set to S7. This temperature sensor must be located in the desired medium.

High-pressure monitoring can occur with an external, high-pressure switch on DI8.

Safety functions

Min./max. suction pressure P_o

The suction pressure is recorded continuously.

If the measured value falls below the set minimum limit, the compressors will immediately cut out.

If it exceeds the max. value, an alarm will be generated once the time delay has elapsed.

Max. condensing pressure P_c

If the condensing pressure reaches the upper permissible value, the controller will connect all condenser fans to keep the pressure down. At the same time, a portion of the compressor capacity will be disconnected. If the pressure remains near the threshold value, even more compressors will be disconnected.

All compressors will be disconnected immediately if the threshold value is exceeded.

LP switch

On/off signal on a DI7 input

If a signal is received, all compressors will immediately be stopped.

When the signal is removed again, the capacity is regulated up again.

HP switch

On/off signal on a DI8 input

If a signal is received, all compressors will immediately be stopped.

Fan capacity will increase depending on how much the P_c measurement exceeds the reference.

When the signal is removed again, the capacity is regulated up again.

Max. discharge gas temperature S_d for digital scroll / stream

Temperature sensor on an AI input.

A signal can be received from a Pt 1000 Ohm sensor on the pressure pipe.

If the temperature nears the set max. temperature, the capacity of the compressor will be increased so that the compressor can cool down itself.

The compressors will be stopped if the temperature reaches up to the set max. temperature value.

Sensor failure

If lack of signal from one of the connected temperature sensors or pressure transmitters is registered an alarm will be given.

- In the event of a P_o error (S4 error), regulation will continue with a set capacity in daytime operation (e.g. 50%), and a set capacity in night operation (e.g. 25%), but with a minimum of one step.
- In the event of a P_c error, the condenser capacity that corresponds to how much compressor capacity is connected will cut in. Compressor regulation will remain normal.
- When there is an error on the S_d sensor the safety monitoring of the discharge gas temperature will be discontinued.
- In the event of an error on the outdoor temperature sensor, Sc3, the permanent setting value will be used as a reference.

NB: A faulty sensor must be OK within 10 minutes before a sensor alarm is cancelled.

General DI alarm

On/off signal on a DI8 input

If the input is used as general alarm input alarm text and delay times can be connected.

Alarm and text will appear when the delay time has elapsed.

Display overview

End-user overview

The images in this daily user interface will depend on how the set-up is made. They will illustrate what is regulated. For example: One suction group, one condenser group, or a combination. See examples below:

1 suction
groupe

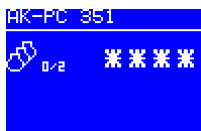

1 condenser
group

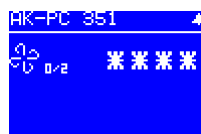

1 suction group
and
1 condenser
group

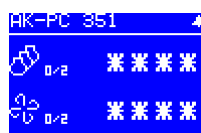

Press "Enter" ↵
to get to the overview

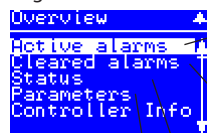

Select a line and
press "Enter" ↵

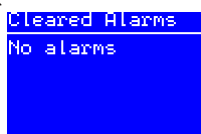
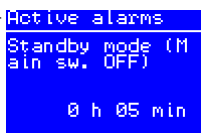

When an alarm is sent from the controller, you must advance to this display to see the alarm text.

Status = either 1 suction group or

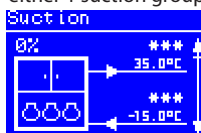

1 condenser group



or

Both suction group
and condenser group

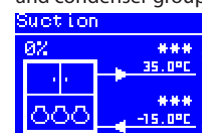

Parameters

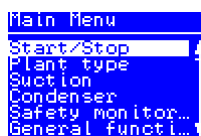

Access to the menus requires password.

Level 1: Only view (100)

Level 2: Change values (200)

Level 3: Change configuration (300).

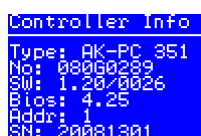

Set-up overview

There are two ways in which the controller can be set up. Select the one that is easiest for you: either “Wizard” or a review of “all parameters”.

Start screen upon delivery

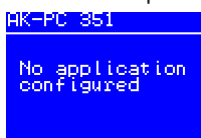

Press “Enter” ↵

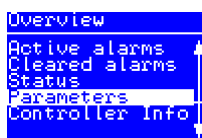

Hold “Enter” ↵ down for 2 seconds to come to password entry



The default password upon delivery is 300. Use the arrow keys to set the password. End by pressing “Enter” ↵

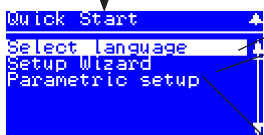

Select a set-up method. End by pressing “Enter” ↵

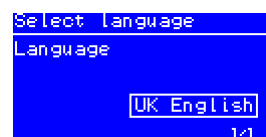

Operating principles

1. Select position using arrow keys
2. Select using “Enter” ↵
3. Use the “X” to return

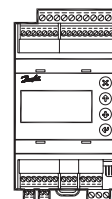

Wizard

Here you will be led through a series of settings, after which the controller will be ready for start. Image 1 of 22 is displayed here.

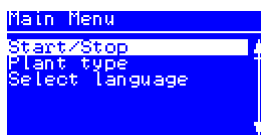

Main Menu

The first setting is the Plant type

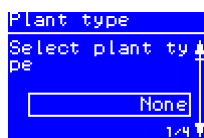

The following options are available here:

- *Comp. + Cond.* = suction group and condenser
- *Condenser* = condenser only
- *Compressor* = suction group only
- *None*

When the Plant type has been selected, it will allow several settings to be made.

For example:

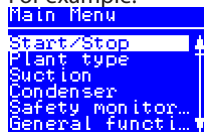

Continue to the next menus.

All settings are explained on the pages that follow

Menu

SW: 1.2x

Start/stop			
	Main switch	<p>Main switch Start and stop regulating here. The configuration settings will require that regulating is stopped. If you try to enter a configuration setting when regulating has started, the controller will ask if regulating should be stopped. When all settings have been made and the main switch is set to "ON", the controller will enable the display of the various measurements. Regulation will start. (If an external main switch has been defined, it must also be "ON" before regulating starts.)</p>	On / Off
	Extern Main switch	<p>External main switch On DI6 an external switch can be connected which can be used to start and stop regulating. If a switch is not connected, the input must be shorted. Both the internal and external main switch must be ON before regulating starts.</p>	
Plant type			
	Select Plant type	<p>Plant settings: The following must be regulated:</p> <ul style="list-style-type: none"> • Compressor group • Condenser group • One compressor group + One condenser group 	Fac: None
	Refrigerant type	<p>Refrigerant setting Before refrigeration is started, the refrigerant must be defined. You may choose between the following refrigerants: R12, R22, R134a, R502, R717, R13, R13b1, R23, R500, R503, R114, R142b, user defined, R32, R227, R401A, R507, R402A, R404A, R407C, R407A, R407B, R410A, R170, R290, R600, R600a, R744, R1270, R417A, R422A, R413A, R422D, R427A, R438A, R513A (XP10), R407F, R1234ze, R1234yf, R448A, R449A, R452A. Warning: Wrong selection of refrigerant may cause damage to the compressor. Other refrigerants: Here Setting "user defined" is selected and then three factors - fac1, fac2 and fac3 and temperature glide (if necessary).</p>	Fac: None
	Unit of setpoints	<p>Define reference settings and readings for saturation temperature or pressure Select pressure or saturation temperature. (Can be set during initial set-up and must not be subsequently changed.)</p>	Temp. / press Fac: Saturated
	Mains frequency	<p>Frequency Set the net frequency</p>	50 Hz / 60 Hz Fac: 50 Hz
	Alarm output	<p>Alarm relay Define an alarm relay here that will be activated in the event of an alarm. 1. Select the alarm priority that will activate the relay</p> <ul style="list-style-type: none"> • No relay • Critical alarms • Critical and serious alarms • All alarms <p>Select whether the relay will be active (pulled) when the alarm is ON, or when it is OFF. (If all relays are used to start/stop compressors and condenser fans, it will not be possible to use an alarm relay.)</p>	DO-demand Fac: No relay
Suction			
	Control status	Regulation status	
	Control status	<p>Read the status of the control circuit here e.g.: <i>No comp</i>=no capacity available (error). <i>Normal</i>=regulation. <i>Alarm comp</i>=alarm situation where the compressor not starts. <i>ON timer</i>=await timer function. <i>Start timer</i>= await timer function. <i>Normal ctrl</i>=regulation in neutral zone. <i>Inj. ON delay</i>=await time delay, <i>Cascade</i>=slave or master. <i>1st comp. del</i>=await first compressor timer. <i>Pump down</i>=suction down until the set limit before compressor stops. <i>Sensor error</i>=emergency cooling due to defective signal. <i>Load shed</i>=power limitation function is active. <i>Sd High</i>=temperature monitoring effect the regulation. <i>Pc High</i>= temperature monitoring effect the regulation. <i>Manual ctrl</i>=manuel operation. <i>Main switch off</i>=regulation stops.</p>	
	Actual zone	<p>You will be able to see how the regulation is in relation to the reference here: P0 error: No regulation - Zone: The desired pressure is below the neutral zone NZ: The pressure is in the neutral zone + Zone: The desired pressure is above the neutral zone</p>	
	Control temp. / Control pres.	The current value of the regulation sensor can be read here	
	Reference	The total regulation reference can be read here	
	Running capacity	Here the connected capacity can be read as a % of total capacity	

	Requested capacity	Here the preferred connected capacity can be read as a % of total capacity	
	No. of running comp.	The number of compressors in operation can be read here	
	Po Pressure	The measured pressure for the Po pressure transmitter can be read here	
	To Saturated temp.	The measured Po pressure converted to temperature can be read here	
	S4 media temp.	The measured S4 sensors actual value can be read here	
	MC Po offset	The size of a reference displacement on Po required from the system unit (suction pressure optimisation function) can be read here	
	Pc Pressure	The measured pressure for pressure transmitter Pc can be read here	
	Tc Saturated temp.	The measured Pc pressure converted to temperature can be read here	
	Day / Night status	The status of the day/night function can be read here	
	LP switch	The measured status on the connected low pressure switch can be read here	
	HP switch	The measured status on the connected high pressure switch can be read here	
	Injection ON	The status of the injection ON signal sent via the system unit to the evaporator controllers can be read here	
	MC Night Setback	The status of the night increase signal received from the system device can be read here	
	Control settings	Regulation settings	
	Control mode	Regulation type The regulation is normally set to "Auto", but it can be changed to "Off" or "Manual". When setting to "Manual", a forced capacity setting can subsequently be entered in %.	MAN / OFF / AUTO Fac: AUTO Min: 0 % Max: 100%
	Setpoint	Enter the set point for the regulation (regulation reference = set point + different offsets) here An offset can originate from a night increase signal or from an override function on the system device.	Min: -80°C (-1.0 bar) Max: 30°C (50 bar) Fac: -15°C (3.5 bar)
	Neutral zone	Set the neutral zone around the reference here. Also see the illustration on page 3.	Min: 0,1 K (0.1 bar) Max: 20 K (5.0 bar) Fac: 6 K (0.4 bar)
	Night offset	If necessary, set the value by which the reference will be raised at night. Keep the setting at 0 if regulating with Po optimisation from a system device.	Min: -25 K (-5.0 bar) Max: 25 K (5.0 bar) Fac: 0 K (0.0 bar)
	Max Reference	Set the highest permissible regulation reference here	Min: -50°C (-1.0 bar) Max: 80°C (50.0 bar) Fac: 80°C (40.0 bar)
	Min Reference	Set the lowest permissible regulation reference here	Min: -80°C (-1.0 bar) Max: 25°C (40.0 bar) Fac: -80°C (-1.0 bar)
	PI control selection	Set how quickly the PI regulation must react here: 1 = slowly, 10 = very quickly. (For "Custom" setting 0, the special settings options will open, i.e. Kp, Tn and time settings around the neutral zone. These options are only for trained staff.)	Min: 0 (custom) Max: 10 Fac: 5
	First step runtime	At start-up, the cooling system must have time to cool down before PI regulation takes over the regulation role and can cut in the next compressor step. Set the time before the next compressor may be started here.	Min: 0 s Max: 300 s Fac: 120 s
	Pump down	Pump-down function To avoid too many compressor starts/stops at a low load, it is possible to define a pump-down function for the last compressor. In this case, the compressor will only be cut out when the current suction pressure is down at the set "Pump-down limit Po". (The setting must be greater than the safety limit for low suction pressure "Po Min Limit".)	Yes /No Fac: No Min: -80°C (-1.0 bar) Max: 30°C (50.0 bar) Facb: -40°C (0.3 bar)
	Emergency cap. day	Emergency capacity in the event of a malfunction of the regulation sensor (suction pressure sensor) Set the desired capacity that will apply during daytime operation.	Min: 0 % Max: 100% Fac: 50%
	Emergency cap. night	Emergency capacity in the event of a malfunction of the regulation sensor (suction pressure sensor) Set the desired capacity that will apply during night operation.	Min: 0 % Max: 100% Fac: 25%
	Comp. start delay	Delay of compressor start after forced closing of expansion valves (at the end of a forced close signal) The delay will result in the system device receiving a start signal for all the evaporator controls involved before the first compressor is started.	Min: 0 s Max: 180 s Fac: 30 s
	Injection OFF delay	Delay of the forced closing of expansion valves, if the controller calls for cut in of compressors, but the compressors are in a locked situation and therefore cannot start.	Min: 0 s Max: 300 s Fac: 120 s
	Configuration	Configuration	
	Control sensor	Select the regulating sensor for the suction circuit: • Pressure transmitter Po - Ratiometric (AKS 32R), 1-5V (AKS 32), 0-20mA, 4-20mA (AKS 33) • Temperature sensor S4 (brine regulation). (Pt 1000 ohm)	AI-demand Po / S4 Fac: Po ratiometric

	Po sensor max range	Pressure transmitter working range Set pressure transmitters upper value. Set in relative pressure.	Min: -1 bar Max: 159 bar Fac: 12 bar																																																																																																																																					
	Po sensor min range	Pressure transmitter working range Set pressure transmitters lower value.. Set in relative pressure.	Min: -1 bar Max: 159 bar Fac: -1 bar																																																																																																																																					
	Compressor mode	<p>Set the type of compressor to be used for regulation: None; 1 single, 2 single, 3 single, 4 single 1 speed, 2 speed, 3 speed, 4 speed, 1 digital, 2 digital, 3 digital 1 stream, 2 stream, 3 stream 1x1 unload, 1x2 unload, 1x3 unload, 2x1 unload</p> <table border="1" style="width: 100%; border-collapse: collapse;"> <thead> <tr> <th>Application</th> <th></th> <th>DO1</th> <th>DO2</th> <th>DO3</th> <th>DO4</th> <th>DO5</th> <th>DO6</th> <th>Ao1</th> </tr> </thead> <tbody> <tr> <td rowspan="4">Single step</td> <td>1 single</td> <td></td> <td></td> <td></td> <td></td> <td></td> <td></td> <td></td> </tr> <tr> <td>2 single</td> <td></td> <td></td> <td></td> <td></td> <td></td> <td></td> <td></td> </tr> <tr> <td>3 single</td> <td></td> <td></td> <td></td> <td></td> <td></td> <td></td> <td></td> </tr> <tr> <td>4 single</td> <td></td> <td></td> <td></td> <td></td> <td></td> <td></td> <td></td> </tr> <tr> <td rowspan="4">Speed on the first. Then single step</td> <td>1 speed</td> <td></td> <td></td> <td></td> <td></td> <td></td> <td></td> <td></td> </tr> <tr> <td>2 speed</td> <td></td> <td></td> <td></td> <td></td> <td></td> <td></td> <td></td> </tr> <tr> <td>3 speed</td> <td></td> <td></td> <td></td> <td></td> <td></td> <td></td> <td></td> </tr> <tr> <td>4 speed</td> <td></td> <td></td> <td></td> <td></td> <td></td> <td></td> <td></td> </tr> <tr> <td rowspan="3">Digital scroll (stream) on the first. Then single step</td> <td>1 digital</td> <td></td> <td></td> <td></td> <td></td> <td></td> <td>Digi </td> <td></td> </tr> <tr> <td>2 digital</td> <td></td> <td></td> <td></td> <td></td> <td></td> <td>Digi </td> <td></td> </tr> <tr> <td>3 digital</td> <td></td> <td></td> <td></td> <td></td> <td></td> <td>Digi </td> <td></td> </tr> <tr> <td rowspan="4">Compressors with unloader</td> <td>1x1 unload</td> <td></td> <td></td> <td></td> <td></td> <td></td> <td></td> <td></td> </tr> <tr> <td>1x2 unload</td> <td></td> <td>1a </td> <td>1b </td> <td></td> <td></td> <td></td> <td></td> </tr> <tr> <td>1x3 unload</td> <td></td> <td>1a </td> <td>1b </td> <td>1c </td> <td></td> <td></td> <td></td> </tr> <tr> <td>2x1 unload</td> <td></td> <td>1a </td> <td></td> <td>2a </td> <td></td> <td></td> <td></td> </tr> </tbody> </table>	Application		DO1	DO2	DO3	DO4	DO5	DO6	Ao1	Single step	1 single								2 single								3 single								4 single								Speed on the first. Then single step	1 speed								2 speed								3 speed								4 speed								Digital scroll (stream) on the first. Then single step	1 digital						Digi		2 digital						Digi		3 digital						Digi		Compressors with unloader	1x1 unload								1x2 unload		1a	1b					1x3 unload		1a	1b	1c				2x1 unload		1a		2a				<p>DO-demand / AO-demand</p> <p>Fac: 2 digital</p>
Application		DO1	DO2	DO3	DO4	DO5	DO6	Ao1																																																																																																																																
Single step	1 single																																																																																																																																							
	2 single																																																																																																																																							
	3 single																																																																																																																																							
	4 single																																																																																																																																							
Speed on the first. Then single step	1 speed																																																																																																																																							
	2 speed																																																																																																																																							
	3 speed																																																																																																																																							
	4 speed																																																																																																																																							
Digital scroll (stream) on the first. Then single step	1 digital						Digi																																																																																																																																	
	2 digital						Digi																																																																																																																																	
	3 digital						Digi																																																																																																																																	
Compressors with unloader	1x1 unload																																																																																																																																							
	1x2 unload		1a	1b																																																																																																																																				
	1x3 unload		1a	1b	1c																																																																																																																																			
	2x1 unload		1a		2a																																																																																																																																			
	Lead comp. size	Set the nominal compressor capacity for the first compressor (it is defined under "Compressor mode") That is, the capacity of either a "Digital scroll", "Stream", "Variable speed"	Min: 1 kW Max: 100 kW Fac: 1 kW																																																																																																																																					
	Comp. size	Set the nominal compressor capacity of the other compressors For single-step only: All are of the same size, including the first. For unloader all: All are of the same size, including the first.	Min: 1 kW Max: 100 kW Fac: 1 kW																																																																																																																																					
	VSD Min. speed	For speed Min. speed for speed regulated compressor	Min: 10 Hz Max: 60 Hz Fac: 30 Hz																																																																																																																																					
	VSD Start speed	For speed Minimum speed at which the compressor will start (must be set to a higher value than "VSD Min. speed")	Min: 20 Hz Max: 60 Hz Fac: 45 Hz																																																																																																																																					
	VSD Max speed	For speed Highest permitted speed for compressor	Min: 40 Hz Max: 120 Hz Fac: 60 Hz																																																																																																																																					
	PWM period time	For "Scroll" and "Stream" Set the period time for the bypass valve (on time + off time)	Min: 10 s Max: 40 s Fac: 20 s																																																																																																																																					
	PWM Min cycle	For scroll Minimum capacity in the time period (without a minimum capacity the compressor will not be cooled)	Min: 10% Max: 50% Fac: 10%																																																																																																																																					
	PWM start cycle	For scroll Start capacity: the compressor will only start when the capacity requirement reaches the value	Min: 10% Max: 60% Fac: 30%																																																																																																																																					

	PWM Max cycle	For scroll Limitation of capacity during time period. There is no limit if the setting in 100%.	Min: 60% Max: 100% Fac: 100%
	Comp. 1 Sd temp.	For "Scroll" and "Stream" Define whether the controller should monitor the discharge gas temperature Sd from a digital scroll or a stream compressor (NTC 86K or Pt 1000 Ohm).	AI-demand No / Yes Fac: No
	Comp. 1 Sd max.	For scroll and Stream and yes to "Comp.1 Sd temp" Set the maximum Sd temperature	Min: 0°C Max: 195°C Fac: 125°C
	Compressor timers	Compressor timers	
	Lead comp. Min ON	Min. On-time for first compressor Set a forced On-time here during which the compressor will remain in operation before it can be switched off again. The setting is to prevent incorrect operation. To prevent a compressor breakdown, the setting must be made in accordance with the requirements of the compressor supplier.	Min: 0 min Max: 60 min Fac: 0 min
	Lead comp. Min OFF	Min. Off-time for first compressor Set the forced Off-time during which the compressor must be off before it can be switched on again. The setting is to prevent incorrect operation.	Min: 0 min. Max: 30 min Fac: 0 min
	Lead comp. Restart	Min. period of time for re-starting the first compressor. Set the forced Off-time during which the compressor must be off before it can be switched on again. The setting is to prevent incorrect operation. To prevent a compressor breakdown, the setting must be made in accordance with the requirements of the compressor supplier.	Min: 1 min. Max: 60 min Fac: 4 min
	Lead comp. Safety delay	Delay time before compressor no. 1 cut out for reasons of safety The time begins when a signal is received on the safety input for the compressor	Min: 1 min. Max: 10 min Fac: 1 min
	Comp. Min ON	Min. On-time for remaining compressors Set a forced On-time here during which the compressor will remain in operation before it can be switched off again. The setting is to prevent incorrect operation.	Min: 0 min. Max: 60 min Fac: 0 min
	Comp. Min OFF	Min. Off-time for remaining compressors Set the forced Off-time during which the compressor must be off before it can be switched on again. The setting is to prevent incorrect operation.	Min: 0 min. Max: 30 min Fac: 0 min
	Comp. Restart	Min. period of time for restarting remaining compressors Set the forced Off-time during which the compressor must be off before it can be switched on again. The setting is to prevent incorrect operation.	Min: 1 min. Max: 60 min Fac: 4 min
	Comp. Safety delay	Delay time before compressors cut out for reasons of safety The time begins when a signal is received on the safety input for the compressor	Min: 1 min. Max: 10 min Fac: 0 min
	Compressor status	Compressor status	
	Comp. 1 Sd gas	Read the Sd temperature of the compressor here.	
	Comp. 1 status	Read the operating status for compressor 1 here. The following information may appear: <i>Power up</i> =startup. <i>Off</i> = compressor stoppt. <i>Manual ctrl</i> =compressor manual controlled. <i>Cut out on safety</i> =stoppt due to signal on DI-input. <i>Restart timer</i> =await timeout of time delay. <i>Ready</i> =ready to start. <i>Min OFF timer</i> =await time out of time delay. <i>Min. ON timer</i> =await timeout of time delay. <i>Full load</i> =compressor works 100%. <i>Running</i> =compressor running. <i>Disabled</i> =stoppt due to service	
	Comp. 2....	The same function for the remaining compressors	
	Compressor capacity	Compressor capacity	
	Comp. 1 cap	Read the connected capacity of the compressor (0-100%) here	
	Comp. 2.....	The same function for the remaining compressors	
	Compressor runhours	Compressor run hours	
	Reset runtime	Reset all of the hour counters and start counters for the subsequent compressors here.	
	Comp.1 Runtime L	Read the total operating time of the compressor (in hours) here	
	Comp.2.....	The same function for the remaining compressors	
	Compressor service	Compressor service	
	Comp.1 out of service	The compressor can be taken out of operation, so that the controller regulates without this compressor. No = Normal regulation Yes = Regulating is carried out without this compressor, and no alarms are generated by it.	Yes /No Fac: No
	Comp.2.....	The same function for the remaining compressors	

Condenser			
	Control status	Regulation status	
	Control status	Here you can read the status of the condenser circuit, e.g.: <ul style="list-style-type: none"> • Main switch = OFF • Capacity control is ready • Capacity control is in normal run mode • Capacity control is set in manual control mode • Capacity forced to 100% due to High Pc/High Sd prevention functions • Capacity forced to 100% due to external HP switch/HP safety/Sd safety limit violation 	
	Control temp./press	The current value of the regulation sensor can be read here	
	Reference	The total regulation reference can be read here	
	Running capacity	Here the connected capacity can be read as a % of total capacity	
	Requested capacity	Here the preferred connected capacity can be read as a % of total capacity	
	No. of running fans	The number of fans in operation can be read here	
	Tc Saturated temp.	The measured Pc pressure converted to temperature can be read here	
	Pc Pressure	The measured pressure for pressure transmitter Pc can be read here	
	S7 Media	Here the measured media temperature with sensor S7 can be read (only if S7 has been selected as the regulation sensor during "Fan configuration")	
	Sc3 air on cond.	The measured outdoor temperature with sensor Sc3 can be read here	
	HP safety switch	The status of the HP safety switch can be read here	
	Day / Night status	Here the status of the day /night function can be read	
	Control settings	Control settings	
	Control mode	Regulation type The regulation is normally set to "Auto", but it can be changed to "Off" or "Manual". When setting to "Manual", capacity can then be forced set in %.	MAN / OFF / AUTO Fac: AUTO Min: 0 % Max: 100%
	Setpoint	Enter the set point for the condenser regulation here. Also set a value if regulating with a fluid reference (set point value used in the event of an outside temperature sensor error).	Min: -25°C (-1.0 bar) Max: 90°C (159 bar) Fac: 35°C (15.0 bar)
	Sc3 offset	Temperature offset for regulation with fluid reference. Regulation reference = Sc3 measurement + Sc3 offset	Min: 0 K Max: 20 K Fac: 6 K
	Min. reference	Set the lowest permissible regulation reference here	Min: -25°C (-1.0 bar) Max: 100°C (159 bar) Fac: 10°C (5.0 bar)
	Max. reference	Set the highest permissible regulation reference here	Min: -25°C (-1.0 bar) Max: 100°C (159 bar) Fac: 50°C (35.0 bar)
	Gain factor Kp	Amplification factor for PI regulation If the Kp value is lowered, regulation runs more smoothly	Min: 1 Max: 30 Fac: 10
	Integration time Tn	Integration time for PI regulation If the Tn value is increased, regulation will run more smoothly	Min: 30 s Max: 240 s Fac: 180 s
	Fan configuration	Configuration of fans	
	Control sensor	Select the regulating sensor for the condensor circuit: <ul style="list-style-type: none"> • Pressure transmitter Po - Ratiometric (AKS 32R), 1-5V (AKS 32), 0-20mA, 4-20mA (AKS 33) • Temperature sensor S7 (Pt 1000 ohm) 	AI-demand Pc / S7 Fac: Pc
	Pc sensor max range	Pressure transmitter working range Set pressure transmitters upper value. Set ini relative pressure.	Min: -1 bar Max: 159 bar Fac: 34 bar
	Pc sensor min range	Pressure transmitter working range Set pressure transmitters lower value.. Set ini relative pressure	Min: -1 bar Max: 159 bar Fac: -1 bar
	Reference mode	Set the reference for regulation here <ul style="list-style-type: none"> • Fixed reference; the reference here will be the defined set point • Variable reference; the reference here will follow the outside temperature, which is measured with Sc3. 	AI-demand Setpoint / Floating Fac: Setpoint

Fan mode	<p>Configuration of fans: Fan speed & DO: Speed controlled fans via AO2 and start/stop via DO output. Fan speed: Speed controlled fans via AO2 4 Fan step: step-by-step . Start/stop via 4 pcs. DO outputs 3 Fan step: step-by-step . Start/stop via 3 pcs. DO outputs 2 Fan step: step-by-step . Start/stop via 2 pcs. DO outputs 1 Fan step: step-by-step . Start/stop via 1 pcs. DO outputs Not used For step-by-step connection, the fans cut in and out sequentially (e.g. 123-321).</p>	<p>DO-demand AO-demand</p> <p>Fac: Fan speed&DO</p>
Control type	<p>Normally, PI-regulation is used, but this can be changed to a P-regulation if the design of the system necessitates this.</p> <ul style="list-style-type: none"> • PI Ctrl: Regulation is carried out here with as little deviation between the reference and measurement as possible. • P-band ctrl: Capacity is cut in here after proportional regulation. 	<p>P / PI Fac: PI</p>
VSD Start speed	<p>Set the start speed of the frequency converter here. The value must be higher than the VSD min. speed value.</p>	<p>Min: 0% Max: 60% Fac: 35%</p>
VSD Min speed	<p>Set the minimum speed of the frequency converter here. If lower capacity is required, this minimum speed should be maintained until the required capacity reach 0%. Hereafter all fans stops completely</p>	<p>Min: 0% Max: 40% Fac: 20%</p>
Fan at comp. off	<p>Here you define whether the fans should operate normally, or whether they must stop when the last compressor is stopped. (Optimized = follows the compressor on/off.)</p>	<p>Min: Normal ctrl. Max: Optimized Fac: Normal ctrl</p>
Fan status	Fan status	
Fan speed	Here a reading of the actually condenser fan capacity in % (speed control)	
Fan 1 status	The status of Step 1 (step 1 or relay for frequency transformer) is indicated here	
Fan 2.....	The status of Step 2, 3, etc. is indicated here	
Safety monitoring		
Po/S4 Min limit	<p>Safety limits for min. Po If a low value is registered, all compressors will cut out</p>	<p>Min: -120°C (-1.0 bar) Max: 30°C (159 bar) Fac: -40°C (0.5 bar)</p>
Po/S4 Max alarm	<p>Alarm limit for high Po If a high value is registered, an alarm will be generated</p>	<p>Min: -30°C (-1.0 bar) Max: 100°C (159 bar) Fac: 100°C (5.0 bar)</p>
Po/S4 Max delay	<p>Delay time for issuing a Po max. alarm</p>	<p>Min: 0 min. Max: 240 min. Fac: 5 min.</p>
Pc max limit	<p>Safety limit for max. Pc If Pc exceeds the value set here minus 3 K, the entire condenser capacity will cut in, and compressor capacity will be reduced by 1/3 for every 30 seconds. If Pc exceeds the threshold value, the entire compressor capacity will immediately cut out, and an alarm will be generated when the delay time expires.</p>	<p>Min: -1 bar Max: 159 bar Fac: 40 bar</p>
Tc Max limit	<p>Safety limit for max. Tc The setting for PC max. limit, converted to temperature, can be read here.</p>	-
S7 max limit	<p>Safety limit for S7 If S7 exceeds the value set here minus 3 K, the entire condenser capacity will cut in, and compressor capacity will be reduced by 1/3 for every 30 seconds. If S7 exceeds the threshold value, the entire compressor capacity will immediately cut out, and an alarm will be generated when the delay time expires.</p>	<p>Min: -50°C Max: 100°C Fac: 100°C</p>
Pc/S7 Max delay	<p>Time delay for Pc max. alarm The alarm will only be generated when the time delay has elapsed.</p>	<p>Min: 0 min. Max: 240 min. Fac: 0 min.</p>
Safety restart time	<p>Delayed start-up following safety cut-out If a safety cut-out has occurred due to "Pc max. limit" or "Po min. limit", the compressors must be kept stopped for a defined period of time. The amount of time can be set here.</p>	<p>Min: 0 min. Max: 60 min. Fac: 1 min.</p>
Sensor alarm reset	<p>Reset alarm after sensor error When a sensor error has occurred, an O.K. signal must be registered within a specified number of minutes before the controller resets the alarm. The regulation will be resumed as soon as the sensor signal is O.K.</p>	<p>Min: 0 min. Max: 30 min. Fac: 10 min.</p>

General functions			
	Digital input	Digital input There are two general digital inputs that can be used by the controller.	
	DI7 config	The DI7 input can be set to: <ul style="list-style-type: none"> • Not used • Receive night signal. The signal will raise the suction pressure with set offset. • Register signal from an LP switch. The signal will cause the controller to stop all compressors. 	DI-demand Night / LP switch Fac: Not used
	DI8 config	The DI8 input can be set to: <ul style="list-style-type: none"> • Not used • Register signal from an HP switch. The signal will start an override of the fan capacity, and the compressor capacity will cut. • Registering a general alarm. An alarm text can be connected along with a general alarm. This text can be seen in the display and can be sent to a system device. 	DI-demand General / HP switch Fac: Not used
	DI8 Alarm tekst	The following alarm texts can be selected when DI8 is selected for general alarm: General alarm, Low pressure, High pressure, High temp, Low temp, Oil level, Oil temp, Liquid level, Leak, Inverter fault.	
	DI8 Alarm delay	Delay time for the DI8 alarm	Min: 0 min. Max: 360 min. Fab: 5 min.
System			
	Display	Select views on the display	-
	Language	Choose from the following languages: English, Danish, Spanish, Portuguese, German, French, Dutch, Russian, Czech, Polish, Turkish, Italian, Croatian, Serbian, Hungarian and Rumanian.	Fac: UK English
	Engineering units	Device Select SI or Imperial (when setting the compressor capacity with U.S. values).	SI / Imperial Fac: SI
	Pressure units	Pressure unit (All pressure readings and settings are in relative pressure.) Select bar or PSIG	Bar / PSIG Fac: bar
	Temperature units	Temperature unit Select °C or °F.	°C / °F Fac: °C
	Screen saver time	Screen saver time If no buttons have been pushed for a specific period of time, the light in the display will be minimised. The light level will be restored upon renewed activity.	Min: 1 min. Max: 60 min. Fac: 1 min.
	User logout time	Log-off time If buttons have not been pressed within a specified period of time, the screen will return to the overview display. Afterwards, the user will have to log on again. If the time is changed, the new time will apply the next time the user logs in. If you log out here without waiting for the time-out period to elapse, go to the "Home" display and hold down the "X" button for 3 seconds.	Min: 1 min. Max: 60 min. Fac: 2 min.
	Display contrast	Display contrast. Here, the contrast can be changed	Min: 0 Max: 100 Fac: 30
	Password	Access code	
	Password level 1	The settings in the controller can be protected with three levels of access codes. Level 1: Only see	Fac: 100
	Password level 2	Level 2: Adjusting installer level	Fac: 200
	Password level 3	Level 3: Configuration of system settings (configuration menu) The access code is a number between 001 and 999.	Fac: 300
	Network	Network	-
	Modbus Address	Set the address of the controller here if it is connected to a system device via data communication.	Min: 1 Max: 120 Fac: 1
	Baudrate	The system unit usually communicates with 38.4. If it is changed in the system unit to for example, "SLV" mode (19.2), setting must also be changed to 19.2 here in the controller. (Setting value =192)	Fac: 384
	Serial mode	The value must not be changed	Fac: 8E1
	Reset to factory	Return to factory settings If this function is set to "YES", all settings will be returned to factory default settings, and the alarm list will be cleared.	

I/O configuration		
	Here you can see which outputs and inputs your settings have established. The connection points shown cannot be changed, but the analog input measurements can be adjusted.	
Digital outputs 1: 2: 3: . 6:	On/off outputs The outputs are set up automatically in the following order: a) If a PWM output is needed, place it on DO6 b) Compressors and unloader valves from DO1 and above c) Next, fans d) Alarm (If DO6 not is used for an PWM output the alarm will be moved to DO6) (One output can be on or off with an activated relay.)	On Off
Digital inputs 1: 2: 3: .. 8:	On/off inputs The following connection points are fixed and cannot be changed: DI1-4 = Safety input for the respective compressor. DI5 = Safety input for fans. DI6 = External start/stop. DI7 = Night signal or LP switch. DI8 = General alarm or HP switch. (The function can be active when the input is connected or disconnected.)	On Off
Analog outputs 1: 2:	Analog outputs AO1 can be used to control the speed of a compressor. AO2 can be used to control the speed of fans. When a function is chosen, the output signal will be 0-10 V.	
Analog inputs 1: 2: 3: 4: .	Analog inputs The inputs are automatically set up AI1: Sc3 outdoor temperature sensor, Pt 1000 ohm AI2: Sd discharge sensor, Pt 1,000 ohm or NTC 86K ohm AI3: S4 temperature sensor, Pt 1000 ohm or Po pressure transmitter: See the type. See sensor's lower pressure. See the sensor's upper pressure. AI4: S7 temperature sensor Pt 1000 ohm or Pc pressure transmitter: See the type. See sensor's lower pressure. See the sensor's upper pressure. (A type AKS 2050 pressure transmitter, for high pressure, emits a signal as an AKS 32R.) All measurements can be calibrated if necessary.	
I/O Status		
Digital outputs 1: . 6:	Status of on/off outputs Here you can see if the function is on or off. (PWM for a digital scroll must be connected to DO6. The pulsing signal will be able to be seen as an alternating on/off signal)	
Digital inputs 1: . 8:	Status of on/off inputs Here you can see the status of the input signal.	
Analog outputs 1: 2:	Status of analog outputs Here you can see the size of the output signals as a % of max. signal.	
Analog inputs 1: . 4:	Status of analog inputs Here you can see pressure and temperature values received by the controller. The values include calibration	
I/O Summary DO: Max 6, Used:___ DI: Max 8, Used:___ AO: Max 2, Used:___ AI: Max 4, Used:___	Inputs and outputs used Here you can see how many of the different inputs and outputs are available. You can also compare this amount with how many have been configured. If too many have been defined, an exclamation mark (!) will appear.	
I/O Manual control		
Digital outputs	Manual control of a relay output Under normal regulation, the function of the relay will be in "Auto". In the event of an override, the function will be switched to either "On" or "Off". Remember to switch to "Auto" when the override is to be completed.	Auto / On / Off
Analog outputs	Manual control of analog output During normal regulation, the function of the output will be "Auto". In the event of an override, the function must first be changed to "Manual", after which the output signal can be changed from 0-100%. Remember to switch to "Auto" when the override is to be completed.	Auto / Man 0-100%

Alarm priorities		
General Standby mode: Sensor error: Refrigerant: Output in MANUAL: General alarm;	Alarm priorities The controller will issue an alarm notification if a specific incident occurs. Each incident is set to indicate the importance of each alarm, but it is possible to modify the importance of each. Choose from between the following priority levels: Critical: Important alarms that require a high level of attention. Severe: Alarms of intermediate importance Normal: No important alarms Disable: Alarms set to this priority level will be cancelled. Factory setting for the alarm can be seen on bottom of this page	Critical Severe Normal Disable
Suction group Low pressure: High pressure: Compressor safety:		
Condenser High pressure: Fan safety:		
Setup Wizard		
Setup Wizard	This wizard will lead you through the necessary settings, i.e. a total of approximately 20 to 25 display screens, depending on what is selected along the way. The selection will also result in a connection to a given input and output. You yourself will see this connection in the IO configuration menu. If applicable, see page 17.	

Alarm list

Alarm text	Reason	Priority setting	Default value
General alarms			
Standby mode (Main sw. OFF)	Alarm when control is stopped by internal or external Main Switch (DI input "Main Switch")	Standby mode	Normal
Po sensor error	Pressure transmitter signal from Po defective	Sensor error	Normal
S4 sensor error	Temperature signal from S4 media temp. sensor defective		
Sd sensor error	Temperature signal from Sd discharge gas temp. Sd defective		
Pc sensor error	Pressure transmitter signal from Pc defective		
S7 sensor error	Temperature signal from S7 media sensor on condenser defective		
Sc3 sensor error	Temperature signal from Sc3 air on condenser defective		
Sd Comp. 1 sensor error	Temperature signal from "Sd comp. 1" discharge gas temp. on digital scroll/Stream compressor is defective		
Refrigerant not selected	Alarm if no refrigerant has been selected	Refrigerant not set	Normal
Output in manual mode	An output is set in manual mode	Output in MAN mode	Normal
IO configuration error	Not all inputs and outout functions have been assigned to hardware Inputs or outputs*	(can not be set)	Normal
GA - "Alarm text"	Alarm on general alarm input DI 8 (DI input "Gen. Alarm" - alarm text depend upon configured text)	General alarm	Normal
Suction alarms			
Po/S4 Low suction pressure	Minimum safety limit for suction pressure Po has been violated	Low pressure Po	Normal
LP safety switch cut out	Low safety limit for external low pressure switch has been violated (DI 7 input)		
Po/S4 High suction pressure	High alarm limit for Po has been exceeded	High pressure Po	Critical
Comp. 1 High disch. temp	Safety limit for discharge temperature of digital scroll/Stream compressor has been exceeded	Compressor safety	Normal
Compressor 1-4 safety cut out	Compressor no. 1-4 has been cut out on general safety input (DI input "Comp.1-4 safety")		
Condenser alarms			
Pc/S7 High condensing pressure	High prevention safety limit for condensing pressure Pc has been violated (3K below safety limit)	High pressure Pc	Critical
HP safety switch cutout	High safety limit for external high pressure switch has been violated (DI 8 input)		
Common fan safety cut out	A Fan is reported defective via common safety input (DI input "Fan safety")	Fan safety	Normal

* The alarm "IO configuration error" is activated if not all IO functions have been assigned to a hardware Input or output.

The reason is that too many functions have been selected via the configuration of the controller.

Go to the menu point "Main menu => IO status => IO summary".

In this screen you can see if you have configured too many functions of a certain type - indicated by an exclamation mark "!"

Please refer to the screen example, were too many DO functions have been configured.

Solve the problem by adapting the DO functions to the max. No of DO outputs.

IO summary	
	Max. Used
DO: ↑	10000
DI: ↓	10000
AO: ↓	10000
AI: ↓	10000

Sensor alarms

Sensor alarms shut off automatically when the sensor has been O.K. for 10 minutes.

If you have corrected the sensor error and want to perform a manual, forced removal of the alarm, go to the "Alarm detail display"

Press and hold the "X" key for 2 seconds here.

Connections when using Setup Wizard

Digital outputs (DO1-DO6):

If you have used the Setup Wizard for the configuration, the controller will automatically assign the outputs in accordance with the following prioritised order:

- PWM outputs for digital scroll or Stream compressor will be located on solid state outputs DO6
- Compressor start and unloaders
- Fans
- Alarm (primarily DO6, but if DO6 is occupied then the first vacant DO).

Digital inputs (DI1-DI8) are established on the following inputs:

- DI1-4: Compressor safety input
- DI5: Fan safety input
- DI6: External Main switch (Start/Stop)
- DI7: LP safety switch or Night status
- DI8: HP safety switch or General alarm input

Analog outputs (AO1-AO2) are established on the following outputs:

- AO1: Compressor speed control
- AO2: Condenser speed control

Analog inputs (AI1-AI4) are established on the following inputs:

- AI1: Sc3 outside temperature
- AI2: Sd discharge gas temperature
- AI3: Po suction pressure or S4 media temperature
- AI4: Pc condensation pressure or S7 media temperature

The assignment of functions on the respective inputs and outputs can be regulated in "IO configuration". Here is an example of 3 compressors and 2 fans:

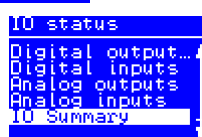
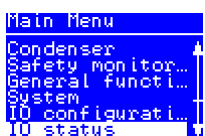
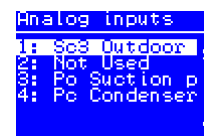
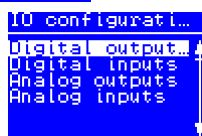

In this image you can see how many outputs and inputs your settings have provided.

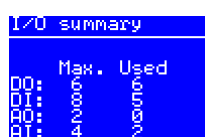

Connections

Connection, lower level

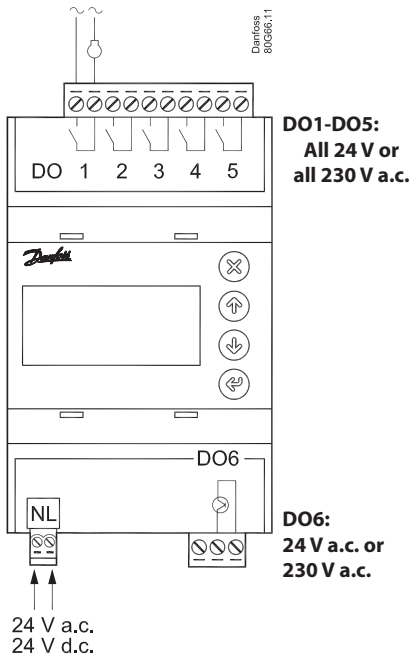

Connection, upper level

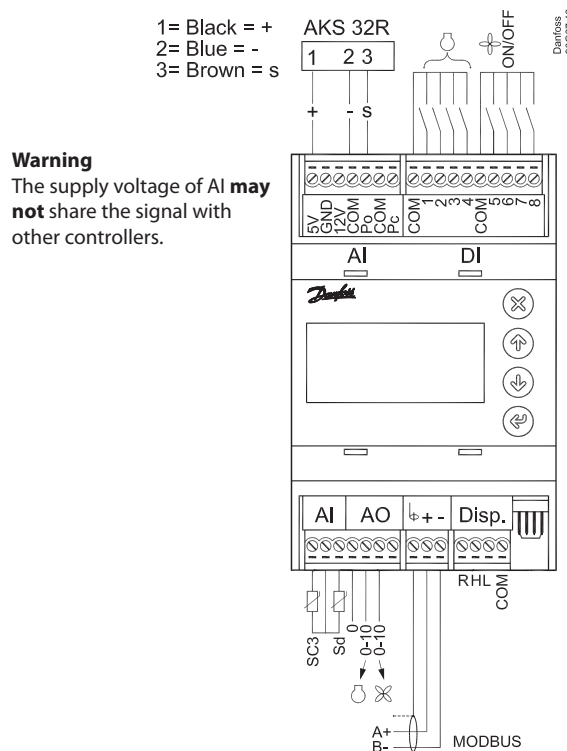

Supply Voltage.

24 V a.c. or 24 V d.c.

DO - Digital outputs, 6 pcs. DO1 - DO6

DO6 is solid state relay.

The relays are de-rated to the specified values.

If an alarm relay is defined, it will be driven under normal operation and it will drop in the event of alarms and insufficient power to the controller.

DO	DO1-DO5	DO6
I Max.	5 A (2)	I _{max.} = 0.5A I _{min.} = 50 mA Leak < 1.5 mA
U	All 24 V or all 230 V AC	24 V a.c. or 230 V a.c.

AI - Analogue inputs, 4 pcs. AI1 - AI4

AI1- Sc3: Pt 1000 ohm, AKS 11 or AKS 21.

AI2 - Sd compressor 1: NTC 86K ohm @ 25°C, from digital scroll or Pt 1000 ohm

AI3: Pressure transmitter Po or temperature sensor S4, Pt 1000 ohm

AI4: Pressure transmitter Pc or temperature sensor S7, Pt 1000 ohm

Pressure transmitters

- Ratiometric: 10-90% of supply, AKS 32R / AKS 2050
- Signal: 1-5 V, AKS 32
- Current: 0-20 mA / 4-20 mA, AKS 33 (supply = 12 V)

DI - Digital switch inputs, 8 pcs. DI1 - DI8

The connection may be a shut-down or interruption function.

Select what is to be activated during configuration.

DI1-4: Safety circuits, compressor 1, 2, 3 and 4

DI5: Safety circuits, condenser fans

DI6: External Main Switch

DI7: Night signal or LP switch

DI8 General alarm or HP switch

AO - Analogue output, 2 pcs. AO1 - AO2

Must be used when using a frequency converter or EC motors. Obtain 0-10 volts from terminals COM and AO1 (compressor), respectively COM and AO2 (fans).

Modbus

It is important that the installation of the data communication cable be done correctly. Cf. separate literature No. RC8AC. Remember termination at the bus termination.

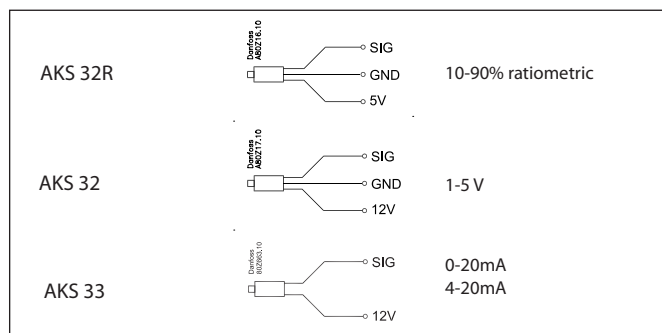

The capacity from the digital scroll compressor

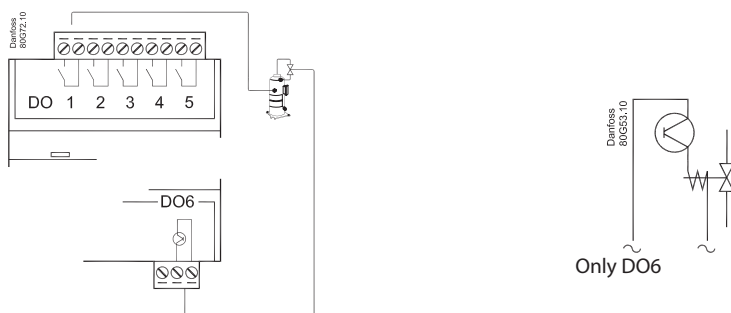

The capacity is divided into period times as "PWM per". 100% capacity is delivered when cooling takes place for the whole period. An off time is required by the bypass valve within the period and an on time is also permitted. There is "no cooling" when the valve is on. The controller itself calculates the capacity needed and will then vary it according to the cut-in time of the capacity control valve. A limit is introduced if low capacity is needed so that the cooling does not go below 10%. This is because the compressor can cool itself. This value can be increased if necessary. The capacity can similarly be limited so that the compressor cannot deliver 100% capacity. It is not normally necessary to limit this max. capacity.

Sd monitoring

When regulating with Sd monitoring, the controller will increase capacity if the temperature nears the Sd limit. This will result in better cooling of the digital scroll compressor.

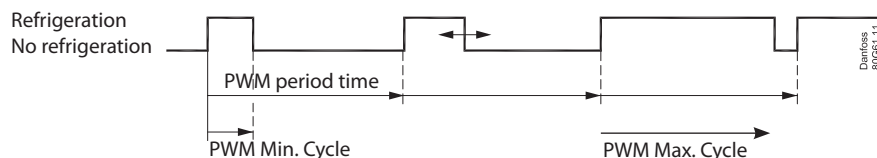

Stream compressor

The PWM signal can also be used to control one stream compressor with one unloader valve.

The compressor capacity is distributed by up to 50% for one relay and the remaining 50-100% for the unloader. The unloader is connected to DO6.

Sd can be monitored like a scroll compressor.

Injection off

The electronic expansion valves in the cooling appliances must be closed when all the compressors are prevented from starting. As a result, the evaporators will not be filled with fluid that can be led to a compressor when the regulation process restarts.

The function can be prompted via data communication.

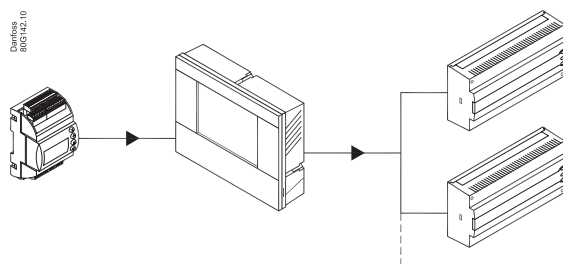

Data

Supply voltage	24 V a.c. +/-15% 50/60 Hz, 9 VA 24 V d.c. (20-60 V), 9 VA	
4 analog Input	Pressure measuring: Ratiometric pressure transmitter type AKS 32R 1-5 volt pressure transmitter type AKS 32 0-20 (4-20) mA pressure transmitter type AKS 33	
	Temperature measurement Pt 1000 ohm/0°C NTC - 86K from digital scroll / stream	
8 digital input	From contact function E.g. to: Start/stop of regulation Monitoring of safety circuits General alarm function	
Relay output to capacity control	5 pcs. SPST (5A)	AC-1: 5 A (ohmic) AC-15: 2 A (inductive)
	1 pcs. Solid State. PWM for scroll - unload	I _{max.} = 0.5A I _{min.} = 50 mA. Leak < 1.5 mA Not short-circuit protected
2 Voltage outputs	0-10 V d.c. Ri = 1 kohm	
Data communication	Modbus for AK-SM 800	
Environments	-20 - 60°C, During operations	
	-40 - 70°C, During transport	
	20 - 80% Rh, not condensed	
	No shock influence / vibrations	
Density	IP 20	
Weight	0,2 kg	
Mounting	DIN-rail	
Connection terminals	max. 2.5 mm ² multi core	
Approvals	EU Low Voltage Directive and EMC demands re CE-marking complied with LVD tested acc. EN 60730-1 and EN 60730-2-9 EMC-tested acc. EN 61000-6-2 and 3 UL approval	

Pressure transmitter / temperature sensor

Kindly refer to catalogue RK0YG...

Capacitive load

The relays cannot be used for the direct connection of capacitive loads such as LEDs and on/off control of EC motors.

All loads with a switch mode power supply must be connected with a suitable contactor or similar.

Mounting /Dimensions

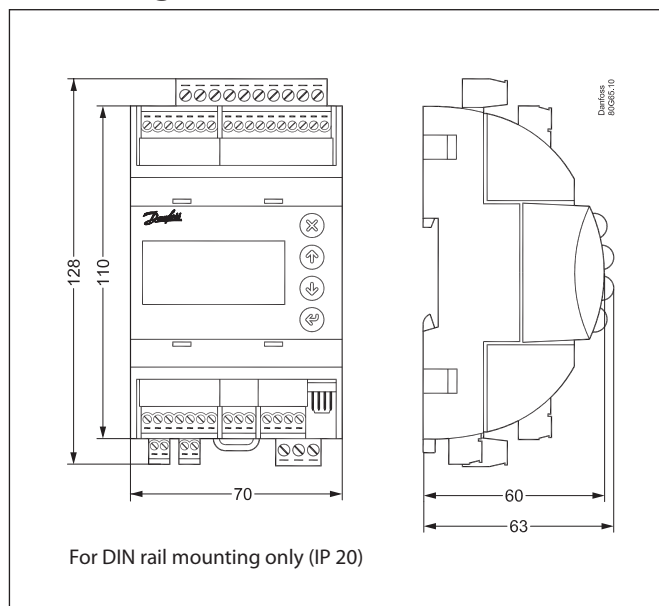

Ordering

Type	Function	Operation		Supply voltage	Code no.
AK-PC 351	Capacity controller		With buttons and display	24 V	080G0289

List of literature

Installation guide for extended operation RC8AC

Here you can see how a data communication connection to ADAP-KOOL® Refrigeration control systems can be established.

Installation considerations

Accidental damage, poor installation, or site conditions, can give rise to malfunctions of the control system, and ultimately lead to a plant breakdown.

Every possible safeguard is incorporated into our products to prevent this. However, a wrong installation, for example, could still present problems. Electronic controls are no substitute for normal, good engineering practice.

Danfoss will not be responsible for any goods, or plant components, damaged as a result of the above defects. It is the installer's responsibility to check the installation thoroughly, and to fit the necessary safety devices.

Special reference is made to the necessity of signals to the controller when the compressor is stopped and to the need of liquid receivers before the compressors.

Your local Danfoss agent will be pleased to assist with further advice, etc.