

EMSKV-L 63 EMV-S

EMC-cable gland, brass nickel-plated with long thread, M63

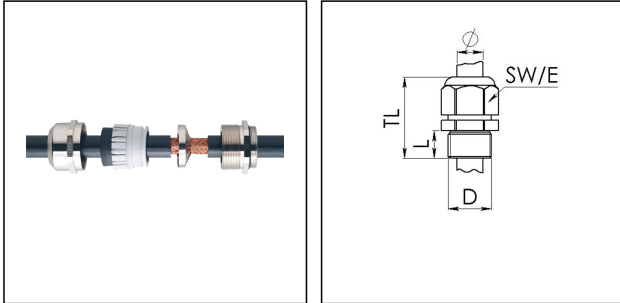

Products may differ in size, colour and appearance to those shown. If you require further information or customisation, please contact us directly.



Material cable gland	Brass nickel-plated
Material sealing gasket	EPDM
Material clamping cage	Polyamide
Material earthing insert	Stainless steel 1.4310
Temp. range min	-40 °C
Temp. range max	100 °C
Protection class	IP68 (5 bar 30 min), IP69
Thread type	M
Ø Connection thread D	63
Lead	1,5
Length screw-in thread L	15 mm
Ø cable diameter min	34 mm
Ø cable diameter max	48 mm
Cable Ø shield external	30 mm - 44 mm
Ø cable diameter UL	38,1 mm - 47,5 mm
Key width SW	68 mm
Collar diameter (E)	75 mm
Total length TL	61 mm - 72 mm
Type of cable anchorage	A
Install. torques cap nut	40 N m
Install. torques fitting	40 N m
Impact category	6
Surface	Nickel-plated
WISKA-Order no.	10102652
Type	EMSKV-L 63 EMV-S

Your Contact:

WISKA Hoppmann GmbH

Kisdorfer Weg 28 · 24568 Kaltenkirchen · Germany

☎ +49-4191-508-0 · 📠 +49-4191-508-209

contact@wiska.de · www.wiska.com

Recommended accessories

RDE 63	10062189
EMMU-EMV 63	10063217
BS 48	10064019

16.12.2020

Your Contact:

WISKA Hoppmann GmbH

Kisdorfer Weg 28 · 24568 Kaltenkirchen · Germany

☎ +49-4191-508-0 · 📠 +49-4191-508-209

contact@wiska.de · www.wiska.com



Your Contact:

WISKA Hoppmann GmbH

Kisdorfer Weg 28 · 24568 Kaltenkirchen · Germany

☎ +49-4191-508-0 · 📠 +49-4191-508-209

contact@wiska.de · www.wiska.com