

EMSKV-L 50 EMV-S

EMC-cable gland, brass nickel-plated with long thread, M50

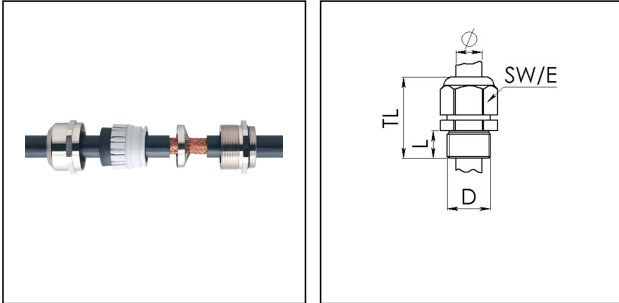

Products may differ in size, colour and appearance to those shown. If you require further information or customisation, please contact us directly.



Material cable gland	Brass nickel-plated
Material sealing gasket	EPDM
Material clamping cage	Polyamide
Material earthing insert	Stainless steel 1.4310
Temp. range min	-40 °C
Temp. range max	100 °C
Protection class	IP68 (5 bar 30 min), IP69
Thread type	M
Ø Connection thread D	50
Lead	1,5
Length screw-in thread L	15 mm
Ø cable diameter min	21 mm
Ø cable diameter max	35 mm
Cable Ø shield external	18 mm - 32 mm
Ø cable diameter UL	24,3 mm - 33,4 mm
Key width SW	55 mm
Collar diameter (E)	61 mm
Total length TL	57 mm - 68 mm
Type of cable anchorage	A
Install. torques cap nut	30 N m
Install. torques fitting	30 N m
Impact category	6
Surface	Nickel-plated
WISKA-Order no.	10102651
Type	EMSKV-L 50 EMV-S

Your Contact:

WISKA Hoppmann GmbH

Kisdorfer Weg 28 · 24568 Kaltenkirchen · Germany

☎ +49-4191-508-0 · 📠 +49-4191-508-209

contact@wiska.de · www.wiska.com

Packing unit

10

Recommended accessories

RDE 50	10062188
EMMU-EMV 50	10063216
BS 35	10064017

16.12.2020

Your Contact:

WISKA Hoppmann GmbH

Kisdorfer Weg 28 · 24568 Kaltenkirchen · Germany

☎ +49-4191-508-0 · 📠 +49-4191-508-209

contact@wiska.de · www.wiska.com



Your Contact:

WISKA Hoppmann GmbH

Kisdorfer Weg 28 · 24568 Kaltenkirchen · Germany

☎ +49-4191-508-0 · 📠 +49-4191-508-209

contact@wiska.de · www.wiska.com