

EMSKV-L 32 EMV-Z

EMC-cable gland, brass nickel-plated with long thread, M32

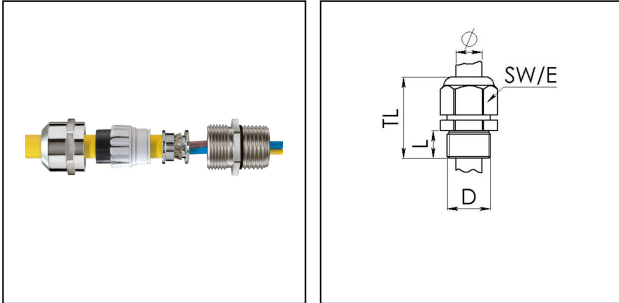

Products may differ in size, colour and appearance to those shown. If you require further information or customisation, please contact us directly.



Material cable gland	Brass nickel-plated
Material sealing gasket	EPDM
Material clamping cage	Polyamide
Material earthing insert	Brass chromium-plated
Temp. range min	-40 °C
Temp. range max	100 °C
Protection class	IP68 (5 bar 30 min), IP69
Thread type	M
Ø Connection thread D	32
Lead	1,5
Length screw-in thread L	15 mm
Ø cable diameter min	13 mm
Ø cable diameter max	21 mm
Ø cable below cable shield	20 mm
Ø cable diameter UL	14,6 mm - 19,5 mm
Key width SW	36 mm
Collar diameter (E)	40 mm
Total length TL	43 mm - 51 mm
Type of cable anchorage	A
Install. torques fitting	20 N m
Install. torques cap nut	15 N m
Impact category	6
Surface	Nickel-plated
WISKA-Order no.	10065186
Type	EMSKV-L 32 EMV-Z

Your Contact:

WISKA Hoppmann GmbH
Kisdorfer Weg 28 · 24568 Kaltenkirchen · Germany
☎ +49-4191-508-0 · 📠 +49-4191-508-209
contact@wiska.de · www.wiska.com

Packing unit

25

ETIM-Classification

EC000441

Recommended accessories



RDE 32	10062186
EMMU-EMV 32	10063214
BS 21	10064014

16.12.2020

Your Contact:

WISKA Hoppmann GmbH

Kisdorfer Weg 28 · 24568 Kaltenkirchen · Germany

 +49-4191-508-0 ·  +49-4191-508-209

contact@wiska.de · www.wiska.com



Your Contact:

WISKA Hoppmann GmbH

Kisdorfer Weg 28 · 24568 Kaltenkirchen · Germany

☎ +49-4191-508-0 · 📠 +49-4191-508-209

contact@wiska.de · www.wiska.com