

EMSKV-L 25 EMV-Z

EMC-cable gland, brass nickel-plated with long thread, M25

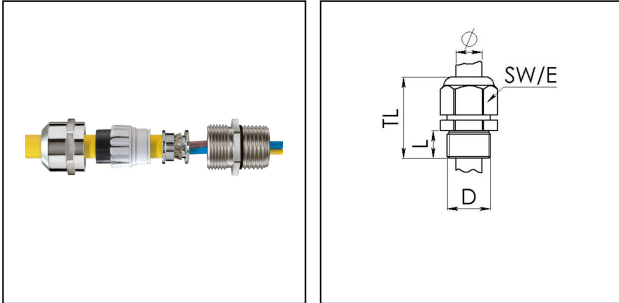

Products may differ in size, colour and appearance to those shown. If you require further information or customisation, please contact us directly.



Material cable gland	Brass nickel-plated
Material sealing gasket	EPDM
Material clamping cage	Polyamide
Material earthing insert	Brass chromium-plated
Temp. range min	-40 °C
Temp. range max	100 °C
Protection class	IP68 (5 bar 30 min), IP69
Thread type	M
Ø Connection thread D	25
Lead	1,5
Length screw-in thread L	12 mm
Ø cable diameter min	9 mm
Ø cable diameter max	17 mm
Ø cable below cable shield	16 mm
Ø cable diameter UL	10,8 mm - 15,8 mm
Key width SW	29 mm
Collar diameter (E)	32 mm
Total length TL	38 mm - 47 mm
Type of cable anchorage	A
Install. torques fitting	10 N m
Install. torques cap nut	10 N m
Impact category	6
Surface	Nickel-plated
WISKA-Order no.	10065185
Type	EMSKV-L 25 EMV-Z

Your Contact:

WISKA Hoppmann GmbH

Kisdorfer Weg 28 · 24568 Kaltenkirchen · Germany

☎ +49-4191-508-0 · 📠 +49-4191-508-209

contact@wiska.de · www.wiska.com

Packing unit

50

ETIM-Classification

EC000441

Recommended accessories

RDE 25	10060768
EMMU-EMV 25	10063213
BS 17	10064012

16.12.2020

Your Contact:

WISKA Hoppmann GmbH

Kisdorfer Weg 28 · 24568 Kaltenkirchen · Germany

 +49-4191-508-0 ·  +49-4191-508-209

contact@wiska.de · www.wiska.com



Your Contact:

WISKA Hoppmann GmbH

Kisdorfer Weg 28 · 24568 Kaltenkirchen · Germany

☎ +49-4191-508-0 · 📠 +49-4191-508-209

contact@wiska.de · www.wiska.com