

Victaulic FireLock™ Innovative Groove System | IGS™ for 1"/DN25 Sprinkler Pipe

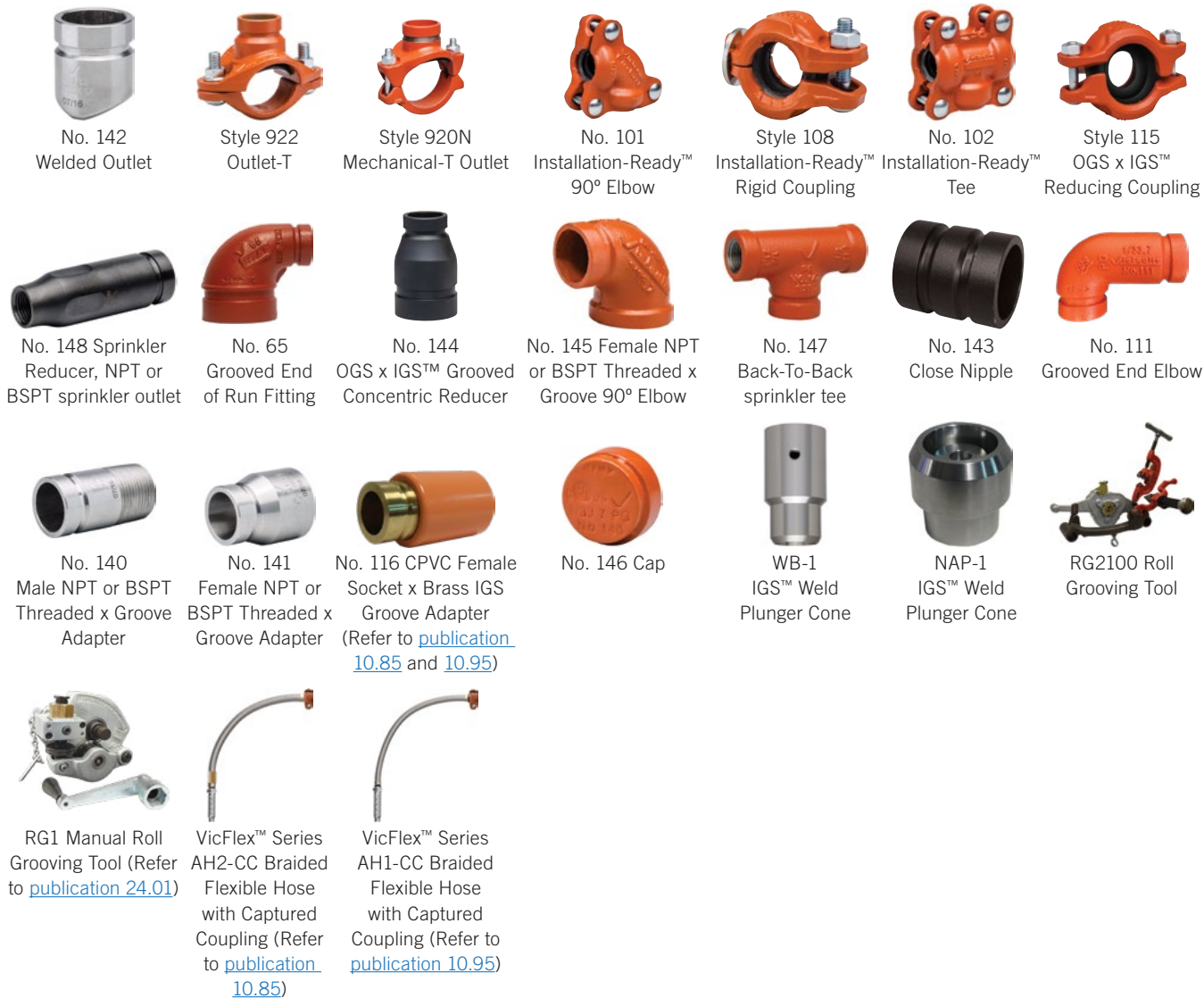

ALWAYS REFER TO ANY NOTIFICATIONS AT THE END OF THIS DOCUMENT REGARDING PRODUCT INSTALLATION, MAINTENANCE OR SUPPORT.

System No.		Location	
Submitted By		Date	

Spec Section		Paragraph	
Approved		Date	

1.0 PRODUCT DESCRIPTION

Pipe Material

- Carbon steel, Schedule 10, Schedule 40. For use with alternative materials please contact Victaulic.
- Carbon Steel
- Stainless Steel
- For exceptions reference section 6.0 Notifications

Maximum Working Pressure

- Up to 365 psi/2517 kPa/25 bar

Pipe Preparation

- Cut (Sch. 40) or roll (Sch. 10 or Sch. 40) grooved in accordance with [publication 25.14](#): Victaulic /GS Groove Specifications

RG2100 Grooving Capability

- 1"/DN25
- Workstation designed to cut, ream and form a roll groove on carbon steel, Sch. 10 or Sch. 40 pipe
- This tool has a minimum pipe length requirement of 4 ½"/114 mm

2.0 CERTIFICATION/LISTINGS



NOTES

- Approvals listed above do not apply to the RG2100 Roll Grooving Tool.

3.0 SPECIFICATIONS – MATERIAL

Housing: Ductile iron conforming to ASTM A536, Grade 65-45-12

Housing Coating:

- Orange enamel
- Red enamel (Europe)
- Optional: Hot dipped galvanized

Gasket:

Grade “E” EPDM (Type A) Vic-Plus™ Pre-lubricated Gasket

EPDM (Violet Color Code). Applicable for wet and dry (oil-free air) fire protection systems only. Listed/Approved for continuous use in wet and dry systems. Listed/Approved for dry systems at -40°F/-40°C and above. NOT COMPATIBLE FOR USE WITH HOT WATER SERVICES OR STEAM SERVICES.

NOTES:

- Reference should always be made to [publication I-100](#), Victaulic Field Installation Handbook for gasket lubrication instructions.
- Services listed are General Service Guidelines only. It should be noted that there are services for which these gaskets are not compatible. Reference should always be made to [publication 05.01](#), Victaulic Gasket Selection Guide for specific gasket service guidelines and for a listing of services which are not compatible.

Bolts/Nuts:

Carbon steel oval neck track bolts meeting the mechanical property requirements of ASTM A449 (imperial) and ISO 898-1 Class 9.8 (M10-M16) Class 8.8 (M20 and greater). Carbon steel hex nuts meeting the mechanical property requirements of ASTM A563 Grade B (imperial - heavy hex nuts) and ASTM A563M Class 9 (metric - hex nuts). Track bolts and hex nuts are zinc electroplated per ASTM B633 Fe/Zn 5, finish Type III (imperial) or Type II (metric).

3.0 SPECIFICATIONS – MATERIAL (CONTINUED)

Coupling Linkage: High Strength Steel with comparable physical properties to that of the Track Bolt (ASTM A449).
Linkage is zinc electroplated per ASTM B633 Fe/Zn 5, Type III Finish

No. 140, 141, 142, 143, 144, 148: Carbon steel meeting the chemical and mechanical property requirements of ASTM A53 Grade A, Type E or S

No. 65, 111, 145, 146, 147: Ductile iron conforming to ASTM A536, Grade 65-45-12

No. WB-1: Steel Alloy

No. NAP-1: Aluminum Alloy

RG2100 Roll Grooving Tool:

Required Power Supply: Power Drive with Foot Switch (½ HP, Universal reversible motor, single-phase, 25-60 HZ)

Accessories/Components:

Tool head assembly

Carriage assembly - accepts RG2100 tool head assembly, Standard Cutter, Standard Reamer and Standard Lever

4.0 DIMENSIONS

No. 142 Welded Outlet

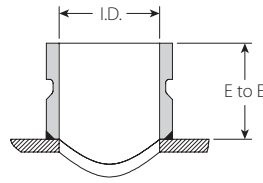

Nominal	Actual Outside Diameter	Inside Diameter	Weight	
inches DN	inches mm	I.D. inches mm	E to E inches mm	Approximate (Each) lb kg
Run x Branch	Run x Branch			
1 ¼ – 1 ½ DN32 – DN40	1.660 – 1.900 42.4 – 48.3	1.049 26.6	1.00 25.4	0.2 0.1
1 ½ – 2 DN40 – DN50	1.900 – 2.375 48.3 – 60.3	1.049 26.6	1.00 25.4	0.2 0.1
2 – 2 ½ DN50 – DN65	2.375 – 3.000 60.3 – 76.1	1.049 26.6	1.00 25.4	0.2 0.1
2 ½ – 3 DN65 – DN80	2.875 – 3.500 73.0 – 88.9	1.049 26.6	1.00 25.4	0.2 0.1
3 – 4 DN80 – DN100	3.500 – 4.500 88.9 – 114.3	1.049 26.6	1.00 25.4	0.2 0.1

4.1 DIMENSIONS

Style 922 Outlet-T

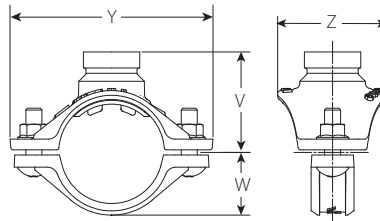

Size		Bolt/Nut		Dimensions						Weight
Nominal inches DN	Actual Outside Diameter inches mm	Qty.	Size inches mm	Minimum Hole Diameter/Hole Saw Size inches mm	Maximum Hole Diameter/ Hole Saw Size inches mm	Y inches mm	V inches mm	W inches mm	Z inches mm	Approximate (Each) lb kg
Run x Branch	Run x Branch									
1 ¼ DN32	1.660 42.4	2	¾ x 1 ¾	1 ¾ 30.0	1 ¼ 32.0	4.13 105.0	1.98 50.3	1.10 27.9	2.70 68.6	1.1 0.5
1 ½ DN40	1.900 48.3	2	¾ x 1 ¾	1 ¾ 30.0	1 ¼ 32.0	4.25 108.0	2.11 53.6	1.22 31.0	2.70 68.7	1.2 0.5
2 DN50	2.375 60.3	2	¾ x 1 ¾	1 ¾ 30.0	1 ¼ 32.0	4.75 120.6	2.34 59.4	1.46 37.1	2.56 65.1	1.2 0.5
2 ½ DN65	2.875 73.0	2	¾ x 1 ¾	1 ¾ 30.0	1 ¼ 32.0	5.50 139.7	2.67 67.8	1.71 43.4	2.56 65.1	1.6 0.7
	3.000 76.1	2	¾ x 1 ¾	1 ¾ 30.0	1 ¼ 32.0	5.52 140.3	2.75 69.8	1.71 43.4	2.56 65.1	1.7 0.8

4.2 DIMENSIONS

Style 920N Mechanical-T Outlet

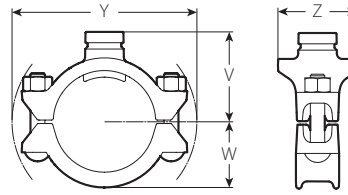

Size		Bolt/Nut		Dimensions						Weight
Nominal inches DN	Actual Outside Diameter inches mm	Qty.	Size inches mm	Minimum Hole Diameter/Hole Saw Size inches mm	Maximum Hole Diameter/ Hole Saw Size inches mm	Y inches mm	V inches mm	W inches mm	Z inches mm	Approximate (Each) lb kg
3 DN80	3.500 88.9	2	1/2 x 2 3/4	1 1/2 38.1	1 5/8 41.0	6.42 163.0	3.12 79.2	2.28 57.9	2.75 69.9	2.7 1.2
4 DN100	4.500 114.3	2	1/2 x 2 3/4	1 1/2 38.1	1 5/8 41.0	186.6 7.35	3.62 91.9	2.69 68.3	2.75 69.10	3.0 1.4

4.3 DIMENSIONS

No. 101 Installation-Ready 90° Elbow

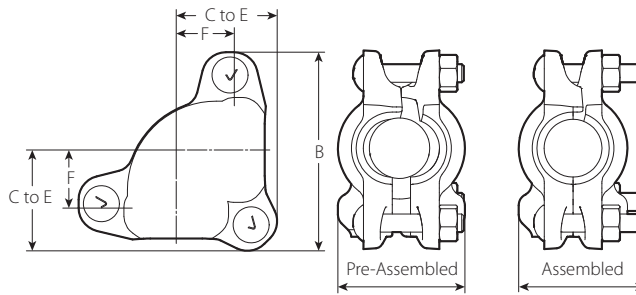

Size		Bolt/Nut		Dimensions					Weight
Nominal inches DN	Actual Outside Diameter inches mm	Qty.	Size inches mm	F Take Out inches mm	C to E inches mm	B inches mm	Pre-Assembled inches mm	Assembled inches mm	Approximate (Each) lb kg
1 DN25	1.315 33.7	3	3/8 x 2 M10 x 50	1.25 32	2.13 54	4.25 108	2.75 70	2.75 70	2.2 1.0

NOTE

- Not for use with grooved sprinklers, for grooved sprinkler connections please refer to [publication 10.65](#) for the Style V9 sprinkler coupling.

4.4 DIMENSIONS

Style 108 Installation-Ready Rigid Coupling

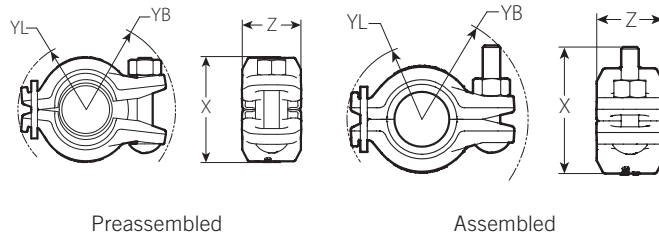

Size		Pipe End Separation ¹	Bolt/Nut		Dimensions								Weight
Nominal inches DN	Actual Outside Diameter inches mm	Allowable inches mm	Qty.	Size inches mm	Pre-Assembled				Assembled				Approx (Each) lb kg
					YL inches mm	YB inches mm	X inches mm	Z inches mm	YL inches mm	YB inches mm	X inches mm	Z inches mm	
1	1.315	0.14	1	3/8 x 2	1.66	2.17	2.58	1.43	1.61	2.29	2.27	1.43	1.5
DN25	33.7	3.6		M10 x 50	42.2	55.2	65.5	36.3	41.0	58.2	57.5	36.3	0.7

¹ The allowable pipe end separation dimension shown is for system layout purposes only. FireLock™ Style 108 rigid couplings are considered rigid connections and will not accommodate expansion or contraction of the piping system.

NOTE

- Not for use with grooved sprinklers, for grooved sprinkler connections please refer to [publication 10.65](#) for the Style V9 sprinkler coupling.

4.5 DIMENSIONS

No. 102 Installation-Ready Tee

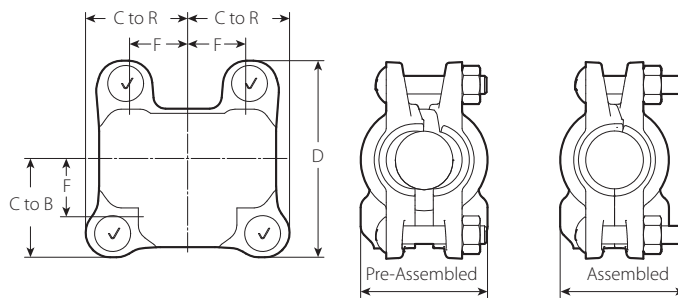

Size		Bolt/Nut		Dimensions						Weight	
Nominal inches DN	Actual Outside Diameter inches mm	Qty.	Size inches mm	F Take Out inches mm	C to B inches mm	C to R inches mm	D inches mm	Pre-Assembled inches mm	Assembled inches mm	Approximate (Each) lb kg	
											1
DN25	33.7	M10 x 50	32	54	54	105	70	70	1.4		

NOTE

- Not for use with grooved sprinklers, for grooved sprinkler connections please refer to [publication 10.65](#) for the Style V9 sprinkler coupling.

4.6 DIMENSIONS

Style 115 OGS x /GS Reducing Coupling

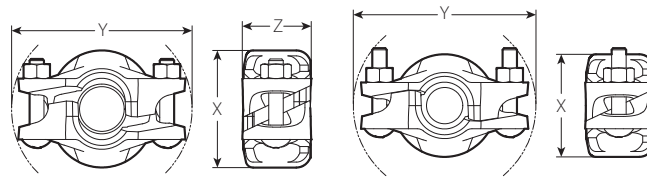

Pre-Assembled

Assembled

Size		Pipe End Separation ²	Bolt/Nut		Dimensions						Weight
					Pre-Assembled			Assembled			
Nominal inches DN	Actual Outside Diameter inches mm	Allowable inches mm	Qty.	Size inches mm	X inches mm	Y inches mm	Z inches mm	X inches mm	Y inches mm	Z inches mm	Approximate (Each) lb kg
1 1/4 DN32	1.660 42.4	0.14 3.6	2	3/8 x 2 M10 x 50	3.13 79	4.75 121	1.75 44	2.63 67	4.75 121	1.75 44	1.9 0.9
1 1/2 x DN25	1.900 x 48.3	0.14 3.6	2	3/8 x 2 M10 x 50	3.25 83	4.88 124	1.75 44	2.88 73	4.88 124	1.75 44	2.1 0.9

² The allowable pipe end separation dimension shown is for system layout purposes only. FireLock™ Style 115 rigid couplings are considered rigid connections and will not accommodate expansion or contraction of the piping system.

NOTE

- Not for use with grooved sprinklers, for grooved sprinkler connections please refer to [publication 10.65](#) for the Style V9 sprinkler coupling.

4.7 DIMENSIONS

No. 148 Sprinkler Reducer

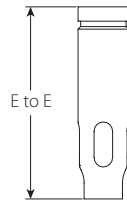

Length E to E inches mm	Size		Threaded Outlet Size		Weight
	Nominal inches DN	Actual Outside Diameter inches mm	inches DN	inches DN	Approximate (Each) lb kg
3 76	1 DN25	1.315 33.7	1/2 DN15	3/4 DN20	0.4 0.2
3.5 89	1 DN25	1.315 33.7	1/2 DN15	3/4 DN20	0.5 0.2
4 102	1 DN25	1.315 33.7	1/2 DN15	3/4 DN20	0.6 0.3
4.5 114	1 DN25	1.315 33.7	1/2 DN15	3/4 DN20	0.6 0.3
5 127	1 DN25	1.315 33.7	1/2 DN15	3/4 DN20	0.7 0.3
5.5 140	1 DN25	1.315 33.7	1/2 DN15	3/4 DN20	0.8 0.3
6 152	1 DN25	1.315 33.7	1/2 DN15	3/4 DN20	0.8 0.4
12 305	1 DN25	1.315 33.7	1/2 DN15	3/4 DN20	1.7 0.8
18 457	1 DN25	1.315 33.7	1/2 DN15	3/4 DN20	2.5 1.1
24 610	1 DN25	1.315 33.7	1/2 DN15	3/4 DN20	3.4 1.5
30 762	1 DN25	1.315 33.7	1/2 DN15	3/4 DN20	4.2 1.9

NOTE

- NPT or BSPT available
- It is acceptable to cut and groove any No. 148 longer than 6"/152mm. The minimum allowable cut length is 6"/152mm for a No. 148.

No. 148 Double Ended Sprinkler Reducer



Length E to E inches mm	Size		Threaded Outlet Size		Weight
	Nominal inches DN	Actual Outside Diameter inches mm	inches DN	inches DN	Approximate (Each) lb kg
36 914	1 DN25	1.315 33.7	1/2 DN15	3/4 DN20	5.0 2.3

NOTE

- 36"/914mm size features sprinkler outlet on both ends for field fabrication.

4.8 DIMENSIONS

No. 65 IGS Grooved End of Run Fitting

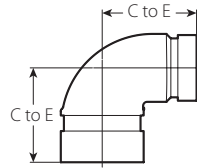

Size		Dimensions		Weight
Nominal inches DN	Actual Outside Diameter inches mm	C to E inches mm	Approximate (Each) lb kg	
1 ¼ DN32	1.660 42.4	1.88 48	0.7 0.3	
1 ½ DN40	1.900 48.3	2.00 51	0.8 0.4	
2 DN50	2.375 60.3	2.25 57	1.2 0.5	
2 ½ DN65	2.875 73.0	2.50 64	1.6 0.7	
3 DN80	3.000 76.1	2.50 64	1.7 0.8	
	3.500 88.9	2.75 70	2.6 1.2	

4.9 DIMENSIONS

No. 144 OGS x IGS Grooved Concentric Reducer

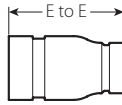

Size		Dimensions		Weight
Nominal inches DN	Actual Outside Diameter inches mm	E to E inches mm	Approximate (Each) lb kg	
1 ¼ DN32	1.660 42.4	3.00 76	0.5 0.2	
1 ½ DN40	1.900 48.3	3.00 76	0.6 0.2	

4.10 DIMENSIONS

No. 145 Female Threaded x Groove 90° Elbow

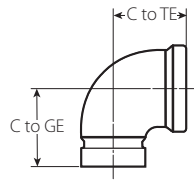

Size				Dimensions		Weight
Nominal inches DN		Actual Outside Diameter inches mm		C-TE inches mm	C-GE inches mm	Approximate (Each) lb kg
Threaded Outlet	Grooved Outlet	Threaded Outlet	Grooved Outlet			
1/2 DN15		0.840 21.3		1.45 36.8	1.60 40.6	0.5 0.2
3/4 DN20	x 1 DN25	1.050 26.9	x 1.315 33.7	1.45 36.8	1.60 40.6	0.5 0.2
1 DN25		1.315 33.7		1.50 38.1	1.60 40.6	0.5 0.2

4.11 DIMENSIONS

No. 147 Back-To-Back Sprinkler Tee

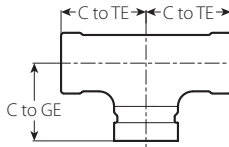

Size						Dimensions		Weight
Nominal inches DN			Actual Outside Diameter inches mm			C-TE inches mm	C-GE inches mm	Approximate (Each) lb kg
Threaded Outlet	Threaded Outlet	Grooved Outlet	Threaded Outlet	Threaded Outlet	Grooved Outlet			
1/2 DN15	x 1/2 DN15	x 1 DN25	0.840 21.3	x 0.840 21.3	x 1.315 33.7	1.75 44.5	1.60 40.6	0.7 0.3

NOTE:

- Approved for use with one or two 1/2" NPT Sprinklers threaded directly into outlet connection(s).

4.12 DIMENSIONS

No. 111 Grooved End Elbow

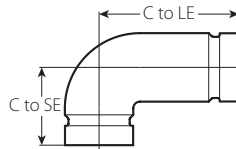

Size		Dimensions		Weight
Nominal inches DN	Actual Outside Diameter inches mm	C to LE inches mm	C to SE inches mm	Approximate (Each) lb kg
1 DN25	1.315 33.7	2.70 69	1.50 38	0.6 0.3

4.13 DIMENSIONS

No. 143 Close Nipple

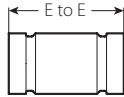

Size		Dimensions	Weight
Nominal inches DN	Actual Outside Diameter inches mm	E to E inches mm	Approximate (Each) lb kg
1 DN25	1.315 33.7	1.5 ³ 38	0.2 0.1
		2 51	0.3 0.1
		2.5 64	0.4 0.2
		3 76	0.4 0.2
		3.5 89	0.5 0.2
		4 102	0.6 0.3
		4.5 114	0.6 0.3
		5 127	0.7 0.3

³ Bolt pad interferences may occur in some installation configurations.

4.14 DIMENSIONS

No. 140 Male Threaded x Groove Adapter

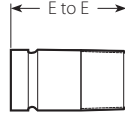

Size		Dimensions	Weight
Nominal inches DN	Actual Outside Diameter inches mm	E-E inches mm	Approximate (Each) lb kg
1 DN25	1.315 33.7	2.50 63.5	0.3 0.1

No. 141 Female Threaded x Groove Adapter

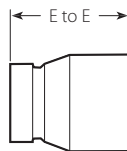

Size		Dimensions	Weight
Nominal inches DN	Actual Outside Diameter inches mm	E-E inches mm	Approximate (Each) lb kg
1 DN25	1.315 33.7	2.00 50.8	0.5 0.2

4.15 DIMENSIONS

No. 146 Cap

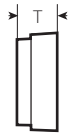

Size		Dimensions	Weight
Nominal inches DN	Actual Outside Diameter inches mm	T inches mm	Approximate (Each) lb kg
1	1.315	0.55	0.2
DN25	33.7	14.0	0.1

4.16 DIMENSIONS

WB-1 Weld Plunger Cone

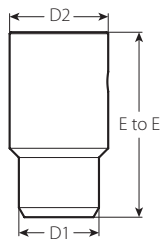

Dimensions			Weight
E to E inches mm	D1 inches mm	D2 inches mm	Approximate (Each) lb kg
3.75 95.3	1.63 41.3	2.00 50.8	2.2 51.0

NOTE

- WB-1 Weld Plunger Cones are for use with the No. 142 weld outlets and protect the groove during weld process.

NAP-1 Weld Plunger Cone

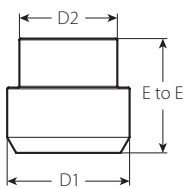

Dimensions			Weight
E to E inches mm	D1 inches mm	D2 inches mm	Approximate (Each) lb kg
1.75 44.5	1.88 47.6	1.50 38.0	0.3 0.2

NOTE

- NAP-1 Weld Plunger Cones are for use with the No. 142 weld outlets and protect the groove during weld process.

4.17 DIMENSIONS

RG2100 Roll Grooving Tool

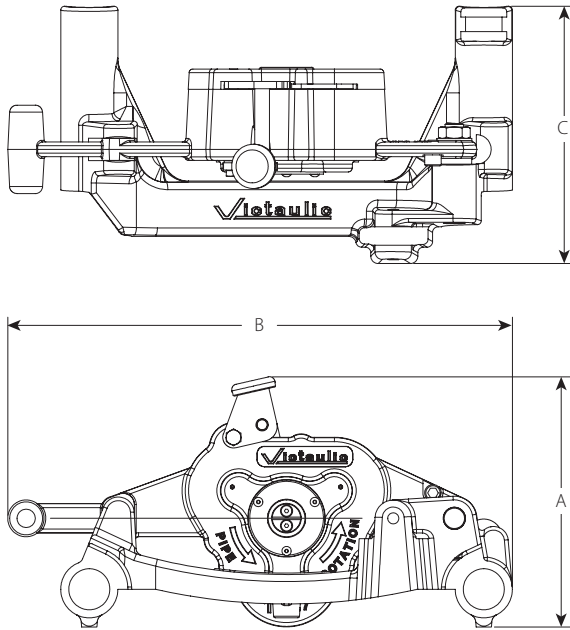

A	B	C	Tool Weight
inches	inches	inches	lb
mm	mm	mm	kg
8.5	17.1	8.7	37.5
216	435	222	17.0

5.0 PERFORMANCE

Friction Flow Data

Size		Equivalent Length of 1" Sch. 40 Pipe (C=120)								
Nominal inches DN	Actual Outside Diameter inches mm	Style 922	Style 920N	No. 101 feet meters	No. 102 (Branch) feet meters	No. 102 (Run) feet meters	No. 111 feet meters	Style 115 feet meters	No. 148 feet meters	No. 144 feet meters
1 DN25	1.315 33.7	See publication 10.52	See publication 11.02	2.0 0.61	5.0 1.52	2.7 0.82	1.5 0.45	–	See note	–
1 ¼ DN32 x 1 DN25	1.660 42.4 x 1.315 33.7	–	–	–	–	–	–	5.7 1.74	–	3.9 1.19
1 ½ DN40	1.900 48.3	–	–	–	–	–	–	5.0 1.52	–	4.3 1.31

NOTE

- In accordance with NFPA 13, friction loss shall be excluded for fittings directly connected to a sprinkler. For hydraulic calculations, Victaulic recommends using the installed length (E-E or cut length) of the No. 148 Sprinkler Reducer as the equivalent length of 1"/DN25 Sch. 40 pipe.

5.0 PERFORMANCE (CONTINUED)

Maximum Working Pressure

Style/No.	cULus psi kPa bar	FM psi kPa bar	LPCB psi kPa bar	VdS psi kPa bar
142 ⁴	365 2517 25	365 2517 25	365 2517 25	232 1600 16
922 ⁴	300 2100 21	300 2100 21	365 2517 25	232 1600 16
920N ⁴	365 2517 25	300 2100 21	365 2517 25	232 1600 16
101 ⁵	365 2517 25	365 2517 25	365 2517 25	232 1600 16
108 ⁵	365 2517 25	365 2517 25	365 2517 25	232 1600 16
102 ⁵	365 2517 25	365 2517 25	365 2517 25	232 1600 16
115 ⁴	365 2517 25	365 2517 25	365 2517 25	232 1600 16
148	365 2517 25	365 2517 25	365 2517 25	232 1600 16
65	365 2517 25	365 2517 25	365 2517 25	232 1600 16
144	365 2517 25	365 2517 25	365 2517 25	232 1600 16
145	365 2517 25	365 2517 25	365 2517 25	232 1600 16
147	365 2517 25	365 2517 25	N/A	N/A
143	365 2517 25	365 2517 25	365 2517 25	232 1600 16
111	365 2517 25	365 2517 25	N/A	N/A
140	365 2517 25	365 2517 25	365 2517 25	232 1600 16
141	365 2517 25	365 2517 25	365 2517 25	232 1600 16
146	365 2517 25	365 2517 25	365 2517 25	232 1600 16

⁴ Maximum pressure rating is 300 psi/21 bar when installed on lightwall steel pipe, as follows:
 Mega-Flow and Mega-Flow-GF steel pipe manufactured by Wheatland Tube Co.
 Mega-Thread steel pipe manufactured by Wheatland Tube Co.
 MLT steel pipe manufactured by Wheatland Tube Co.
 WLS steel pipe manufactured by Wheatland Tube Co.
 Eddy Flow steel pipe manufactured by Bull Moose Tube Co.
 Eddythread steel pipe manufactured by Bull Moose Tube Co.
 EZ-Thread steel pipe manufactured by Youngstown Tube Co.
 Fire-Flo steel pipe manufactured by Youngstown Tube Co.
 Easy-Flow pipe manufactured by Borusan Mannesmann

⁵ Maximum pressure rating is 300 psi / 21 bar when installed on lightwall steel pipe, as follows:
 Mega-Thread steel pipe manufactured by Wheatland Tube Co.
 MLT steel pipe manufactured by Wheatland Tube Co
 WLS steel pipe manufactured by Wheatland Tube Co
 Eddythread steel pipe manufactured by Bull Moose Tube Co.
 EZ-Thread steel pipe manufactured by Youngstown Tube Co.

6.0 NOTIFICATIONS

WARNING



- Read and understand all instructions before attempting to install any Victaulic products.
 - Always verify that the piping system has been completely depressurized and drained immediately prior to installation, removal, adjustment, or maintenance of any Victaulic products.
 - Wear safety glasses, hardhat, and foot protection.
- Failure to follow these instructions could result in death or serious personal injury and property damage.

- These products shall be used only in fire protection systems that are designed and installed in accordance with current, applicable National Fire Protection Association (NFPA 13, 13D, 13R, etc.) standards, or equivalent standards, and in accordance with applicable building and fire codes. These standards and codes contain important information regarding protection of systems from freezing temperatures, corrosion, mechanical damage, etc.
- The installer shall understand the use of this product and why it was specified for the particular application.
- The installer shall understand common industry safety standards and potential consequences of improper product installation.
- It is the system designer's responsibility to verify suitability of materials for use with the intended fluid media within the piping system and external environment.
- The material specifier shall evaluate the effect of chemical composition, pH level, operating temperature, chloride level, oxygen level, and flow rate on materials to confirm system life will be acceptable for the intended service.

Failure to follow installation requirements and local and national codes and standards could compromise system integrity or cause system failure, resulting in death or serious personal injury and property damage.

WARNING



Failure to follow instructions and warnings could result in serious personal injury, property damage, and/or product damage.

- Before operating or servicing any grooving tools, read all instructions in the manual and all warning labels on the tool.
- Wear safety glasses, hardhat, foot protection, and hearing protection while working around the tool.
- Save the operating and maintenance manual in a place accessible to all operators of the tool

If you need additional copies of any literature, or if you have questions concerning the safe and proper operation of the tool, contact Victaulic, P.O. Box 31, Easton, PA 18044-0031, Phone: 1-800-PICK VIC, E-Mail: pickvic@victaulic.com.

NOTICE

- Victaulic does not recommend the use of any furnace butt-welded pipe with sizes 2"DN50 and smaller Victaulic gasketed joint products. This includes, but is not limited to, ASTM A53 Type F pipe.

7.0 REFERENCE MATERIALS

- [10.06: FireLock Installation-Ready Fittings](#)
- [10.52: Style 922 Outlet Tee](#)
- [10.85: VicFlex Series AH2 ad AH2-CC Braided Hose](#)
- [11.02 Mechanical-T Bolted Branch Outlets](#)
- [25.14: Victaulic IGS Groove Specification](#)
- [I-101-103: FireLock™ Installation-Ready™ Fittings Installation Instruction](#)
- [I-102: FireLock™ Installation-Ready™ Fittings Installation Instruction](#)
- [I-108: FireLock™ Installation-Ready™ Coupling](#)
- [I-115: FireLock EZ™ Installation-Ready™ Reducing Coupling Installation Instruction](#)
- [I-ENDCAP: Victaulic End Cap Installation Safety Instructions](#)
- [I-V9: Style V9 Victaulic FireLock™ IGS™ Installation-Ready™ Sprinkler Coupling](#)
- [TM-RG2100: Operating and Maintenance Instructions Manual](#)

Victaulic No. 148		
Length	½" DN15 outlet	¾" DN20 outlet
E to E inches mm	Equivalent Length of 1" Sched. 40 Pipe (C=120)	
	feet meters	
≤6 152	6.6 2.0	3.8 1.2
6 – 12 152 – 305	5.5 1.7	3.8 1.2
12 – 18 305 – 457	6.2 1.9	4.3 1.3
18 – 24 457 – 610	6.7 2.0	4.7 1.4
24 – 30 610 – 762	7.1 2.2	5.2 1.6
30 – 36 762 – 914	7.4 2.3	5.4 1.6

NOTE

- When installed in pipe to pipe connections or it is required by the authority having jurisdiction, the equivalent length data in the table above may apply.

User Responsibility for Product Selection and Suitability

Each user bears final responsibility for making a determination as to the suitability of Victaulic products for a particular end-use application, in accordance with industry standards and project specifications, and the applicable building codes and related regulations as well as Victaulic performance, maintenance, safety, and warning instructions. Nothing in this or any other document, nor any verbal recommendation, advice, or opinion from any Victaulic employee, shall be deemed to alter, vary, supersede, or waive any provision of Victaulic Company's standard conditions of sale, installation guide, or this disclaimer.

Intellectual Property Rights

No statement contained herein concerning a possible or suggested use of any material, product, service, or design is intended, or should be construed, to grant any license under any patent or other intellectual property right of Victaulic or any of its subsidiaries or affiliates covering such use or design, or as a recommendation for the use of such material, product, service, or design in the infringement of any patent or other intellectual property right. The terms "Patented" or "Patent Pending" refer to design or utility patents or patent applications for articles and/or methods of use in the United States and/or other countries.

Note

This product shall be manufactured by Victaulic or to Victaulic specifications. All products to be installed in accordance with current Victaulic installation/assembly instructions. Victaulic reserves the right to change product specifications, designs and standard equipment without notice and without incurring obligations.

Installation

Reference should always be made to the [Victaulic installation handbook](#) or installation instructions of the product you are installing. Handbooks are included with each shipment of Victaulic products, providing complete installation and assembly data, and are available in PDF format on our website at www.victaulic.com.

Warranty

Refer to the Warranty section of the current Price List or contact Victaulic for details.

Trademarks

Victaulic and all other Victaulic marks are the trademarks or registered trademarks of Victaulic Company, and/or its affiliated entities, in the U.S. and/or other countries.