

199410V

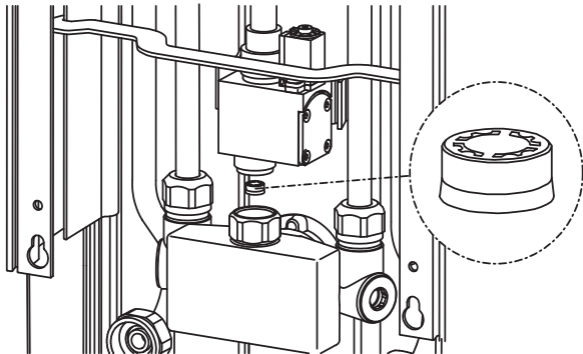

®



ORAS GROUP

Isometsäntie 2
P.O. Box 40
FI-26101 Rauma
Finland
Tel. +358 2 83 161
Fax +358 2 831 6300
Info.Finland@oras.com



ISO 9001 ISO 14001
OHSAS 18001



DNV

CERTIFIED
ORGANISATION

943103/06/11

www.oras.com