

CONTENT

1.	Manufacturer	1
2.	General safety information	1
3.	Purpose	2
4.	Product compliance	2
5.	Degree of protection and technical data	2
6.	Luminaire characteristics	3
7.	Types	3
8.	Mounting and installation	4
9.	Dimensions	4
10.	Spare parts and accessories	5
11.	Inspection, maintenance, repair and overhaul	5
12.	Responsibility and authorization	5
13.	Storage and transport	6
14.	Manufacturer's warranty	6
15.	Marking	6

1. MANUFACTURER

TEP Ex d.o.o.
Prilaz dr. Franje Tuđmana 6
HR-49210 ZABOK
Tel: +385 49 222 900
Fax: +385 49 426 450
Web: www.tepex.hr

2. GENERAL SAFETY INFORMATIONS**WARNING!**

The user manual contains basic information about the product. Mounting, installation, usage and maintenance should be carried out under this user manual to provide and ensure safe operation within the nominal characteristics. This user manual complement national Regulation and Standards. The responsible person shall ensure their implementation. Failure off implement this user manual can reduce explosion protection and endanger people, property and the environment. Any improper and illegal actions as well as non-compliance with the provisions of this user manual excludes all responsibility by manufacturer side.

Before installation/commissioning:

- Carefully read all instructions,
- Execute proper training of responsible personnel,
- Check that the contents of these instructions is fully understandable by the responsible personnel,
- Make sure that all the requirements and national Regulations as well as all special security measures are applied.

In lack of understanding:

- Contact the manufacturer.

During operation:

- Ensure that this user manual and other work instructions are available to the responsible staff at all times,

- Check the implementation of these instructions and all other safety user's instructions.

3. PURPOSE

Explosion protected pendant light fitting type LED PLFS 50 / . , is intended for general lighting in industrial areas with potentially explosive atmosphere Zones 1, 2, 21, 22 in accordance with EN 60079-10-1/-2: 2009. The quality of the materials ensures compliance with standard functionality in standard industrial atmosphere. For special requirements please contact the manufacturer.

4. PRODUCT COMPLIANCE

The product complies with the ATEX Directive 94/9 EC and standards: EN 60079-0:2012,



- EN 60079-1:2007,
- EN 60079-7:2007,
- EN 60079-31:2009.

The product has been developed, manufactured and tested according to the existing state of technique accordance with the standards EN 9001:2008 and EN ISO / IEC 80079-34:2011.

- The product is in compliance with the LV Directive 2006/95 EC.
- The product is in compliance with the RoHS Directive 2002/95 EC.
- The product is in compliance with EMC Directive 2004/108 EC and standards EN 55015, EN 61000-3-2, EN 61000-3-3, EN 61000-4-2,3,4,5,6,8,11 , EN 61547, EN 55024.

5. DEGREE OF PROTECTION AND TECHNICAL DATA

Category and explosion protection type:

-  II 2G Ex de IIC T6 Gb
-  II 2D Ex tb IIIC T80°C Db



Ambient temperature: $-40^{\circ}\text{C} \leq T_a \leq +50^{\circ}\text{C}$

Mechanical protection: IP 66 according to EN 60529:1991+A1:2000, category 1

Shock resistance: IK 08 according to EN 62262:2002

Class of protection: I (protective earthing) according to EN 60598-1:2008

Type-examination certificate: EXA 14 ATEX 0028

Certificate:	EXA 14 ATEX 0028
Mark:	 CE_{2465}
Category and explosion protection:	 II 2G Ex de IIC T6 Gb II 2D Ex tb IIIC T80°C Db
Ambient temperature:	$-40^{\circ}\text{C} \leq T_a \leq +50^{\circ}\text{C}$
Mechanical protection:	IP 66
Resistance to shock:	IK 08
Class of protection	I (PE - protective earthing))
Rated voltage (Type 1):	90 - 305 V AC (50-60Hz) or 127 - 143 V DC
Rated voltage (Type 2):	12 - 60 V DC
Frequency:	50/60 Hz
Rated power:	60W
Power factor:	$\cos \phi > 0,96$
LED driver:	LED driver PLFS LED 50, HSG-70-24, MEANWELL Co.Ltd. with OVP, OCP, OTP protection
Rated luminous flux:	- 7500 lm at $t_{amb} = 25^{\circ}\text{C}$
Estimated service life:	- 50 000 working hours at $t_{amb} = 40^{\circ}\text{C}$
Failure rate:	- L90F10
Terminals:	- terminals for phase and neutral conductors L1, L2, L3, N; max 2 x 2,5 mm ² sol(r), sol(s), f - terminal for protective earthing -PE; max 2 x 6 mm ² sol(s), f - terminal for external grounding, equipotential bounding - max 2 x 6 mm ² sol(s), f - torque screw for terminals is 1,2 Nm
Cable entries	two entries ISO 25

Glands and plugs:

- Ex e M25
- pressure screw for the threaded nut of the cable glands is 2,5 Nm and for intermediate glands and plugs is 3,5 Nm

Screws for the terminal chamber:

- screw M5x2 (Z4) – 4.8
- tightening Torque 1,5 Nm

Weight:

- 7,4 kg with mounting set PLFS-T 20-130

6. LUMINAIRE CHARACTERISTICS**POLAR CURVE**

(based on photometric light fitting test report)

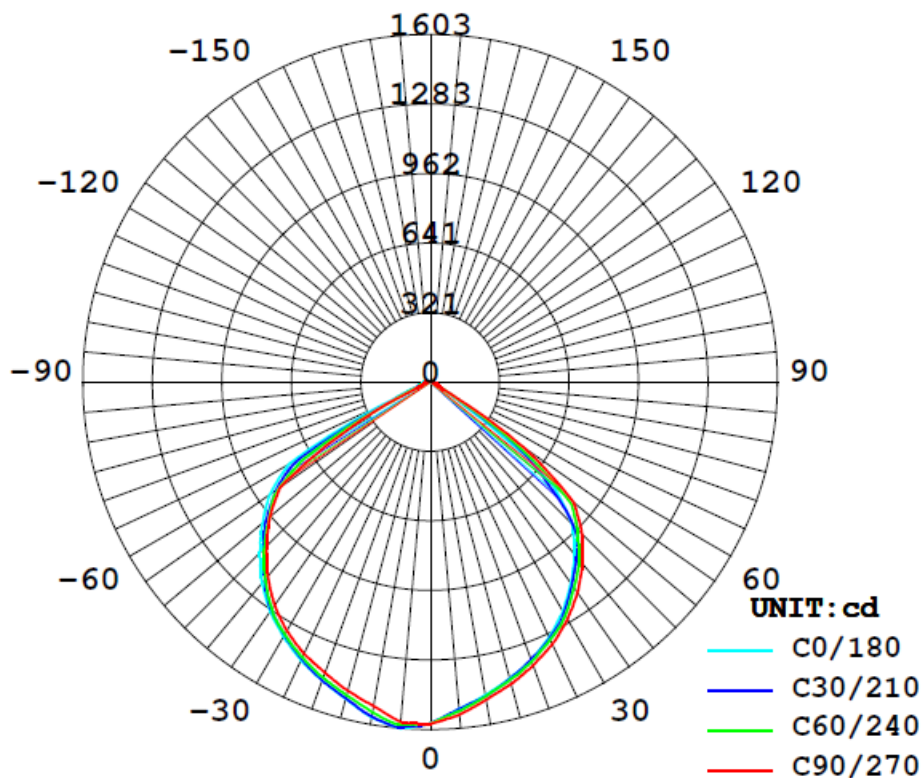
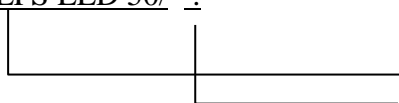
**7. TYPES**PLFS LED 50/ .**Basic type****Rated voltage :**

- 1 90 - 305 V AC / 127 - 143 V DC
- 2 12 - 60 V AC / DC

8. MOUNTING AND INSTALLATION

The light fitting comes standard with Ex-e cable gland M25 (for cable 6-15mm), Ex-e plug M25 and without protection grid or accessories for suspension mounting.

Mounting and installation of light fitting is carried out according to the labeled technical data and the additional manufacturer's instructions, national rules and regulations, as well as the generally recognized rules of technique. Only under this conditions the explosion protection that is committed with type certificate will be confirmed.

The quality of the used materials ensures compliance in the "standard" industrial atmosphere. For special requirements please contact the manufacturer.



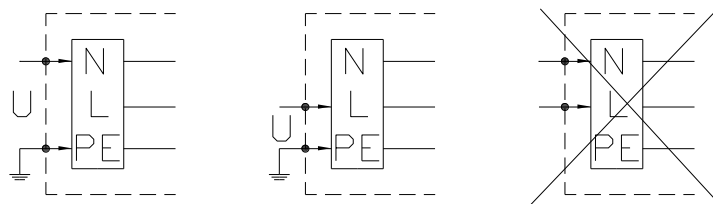
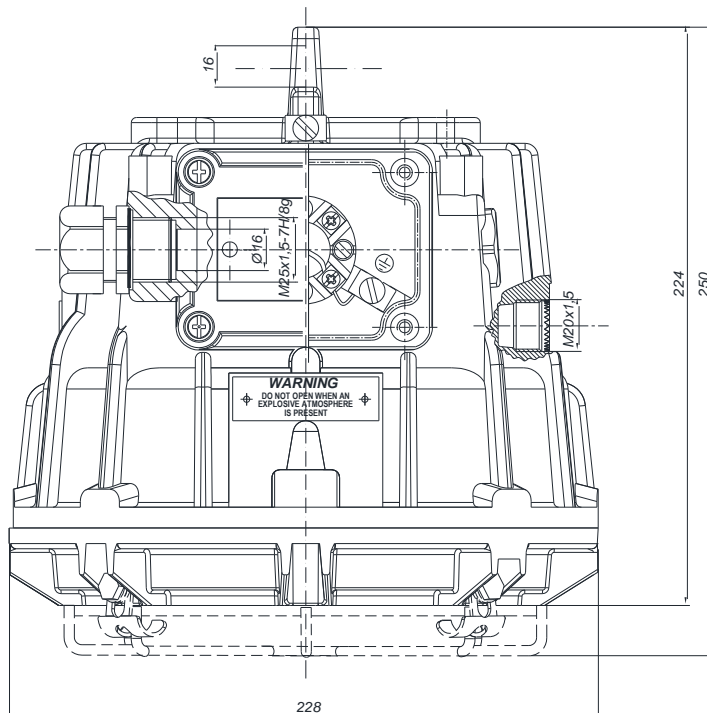

Opening Ex d terminal chamber should be done by unscrewing the blocking screw M5x25. Unused entry should be closed by Ex e ATEX II 2G, II 2D certified plug. It is necessary to check that the cable is clean and undamaged. Particular attention should be paid to the selection of the inner sealing rings of the cable glands to the outside diameter of the cable. Pressure screw and intermediate gland have to be tightened with nominal torque. Electrical connection should be performed in Ex e chamber by connecting cables on Ex e terminals - L + N + PE by tightening the terminal screws with nominal torque. Potential equalization / external earthing terminal have to be connected to external ground circuit.

Insulation resistance is routine factory tested over 100 M Ω / 500 V DC.

Dielectric strength is routine factory tested on 1500 V AC between neutral (N) and protection earth (PE) and phase (L) and protection earth (PE). Testing between phase (N) and neutral (L) is not allowed.

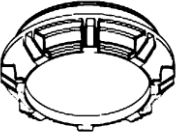
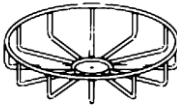
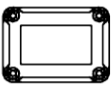
**9. DIMENSIONS**

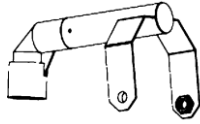
10. SPARE PARTS AND ACCESSORIES

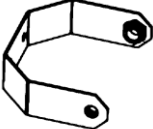
Spare parts	Description	Code	Accessories	Description	Code
	PLFS LED 50 The glass protective framework, set	PLFS LED 10-120		PLFS LED 50 Protection grid, set	PLFS LED 10-130
	PLFS-T Ex-e terminal chamber cover, set	PLFS 10-150		PLFS-T External reflector, set	PLFS 20-100
	Ex-e cable gland ISO25, set	SPU 25		PLFS-T lamp holder for lamppost ϕ 1 1/2", set	PLFS 20-120
	Ex-e plug ISO25, set	SPC 25		PLFS-T bracket for wall mounting, set	PLFS 20-130

11. INSPECTION, MAINTENANCE, REPAIR AND OVERHAUL

Inspections are carried out in accordance with IEC 60079-17:2007 / C 1: 2008, general and special conditions of manufacturer and users Regulations and includes inspection of parts on which the explosion protection depends, especially:

- the housing, terminal chamber, glass protective framework, cable gland, plugs, protective glass and seal are without rupture and damage,
- the glands, plugs, terminals, screw of the terminal chamber and locking bolt on the glass protective framework are fastened with nominal torque

In to the parts for maintenance and repair belongs all the parts provided by the manufacturer and indicated in the list of spare parts. All other procedures have the character of repair. All the repairs are performed by the manufacturer or the manufacturer's authorized personal and the original parts have to be provided according to the product documentation, all in accordance with EN 60079-19:2011.

Overhaul and modifications are not allowed.

If repair or any other procedure are performed on the product by unauthorized person, all producer responsibility for the product and the warranty and the manufacturer's declaration of conformity becomes invalid.

12. RESPONSIBILITY AND AUTHORIZATION

This instruction is the basic information about the product. It is complementing with the corresponding national laws and regulations.

Production, use, certification and supervision are determined at the national level:

- a) Regulations concerning equipment and protective systems intended for use in potentially explosive atmospheres EU directive 94/9 EC (ATEX 94)
- b) Regulations on minimum requirements for safety and health protection of workers and technical inspection of facilities, equipment, installations and equipment in hazardous areas EU directive 1999/92/EC (ATEX 137).

The responsible person shall ensure their implementation at the working facility

13. STORAGE AND TRANSPORT

Transportation and storage of the light fitting is only allowed in the original cardboard box.

14. MANUFACTURER'S WARRANTY

The manufacturer provides a Warranty on the product for a period of five year under the provisions of this User manual and the Law. This statement has the force of Warranty sheet.

15. MARKING

LED light fitting PLFS 50 / . is marked with the marking label with the technical data and a warning label:

Warning label:

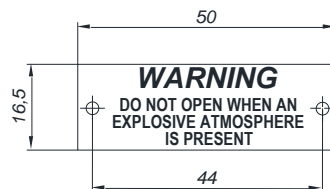

Marking label with the technical data (outside):

Type 1:

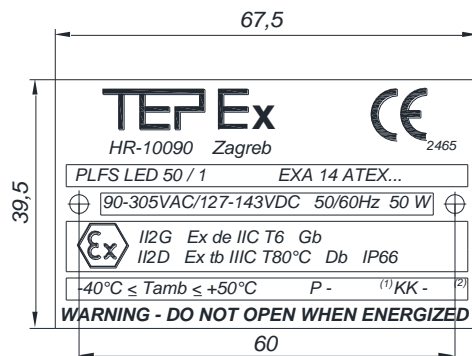

Type 2:

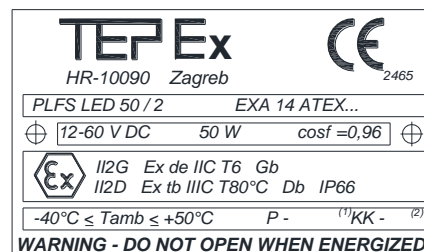

Marking label with the technical data (inside):

Type 1:

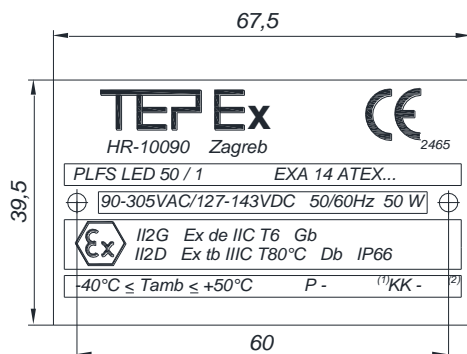

Type 2:

