

SKV 7

Cable gland, polyamide

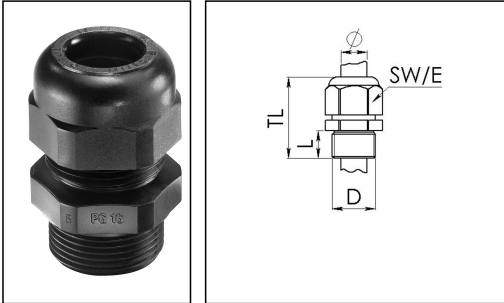

Product illustrations are exemplary and may differ from the chosen product. Further variants and individual customization, we will gladly provide you on request.



Material cable gland	Polyamide
Material sealing gasket	EPDM
Temp. range min	-40 °C
Temp. range max	100 °C
Intermittent temp. range	120 °C
Protection class	IP 68, 5 bar 30 min
Thread type	PG
Connection thread size D	7
Length screw-in thread L	9 mm
Cable diameter min	3 mm
Cable diameter max	6 mm
Key width SW	15 mm
Collar diameter (E)	16 mm
Total length TL	28 mm - 32 mm
Glow wire test	750 °C
Type of cable anchorage	A
Product Color	RAL 9005
Order no. RAL 9005	10066191
Type	SKV 7
Packing unit	50
ETIM-Classification	EC000441

Recommended accessories

MUG 7	10060680
ADR 7	10061419

22.11.2015

