

ESSKE 63

Ex-cable gland, stainless steel

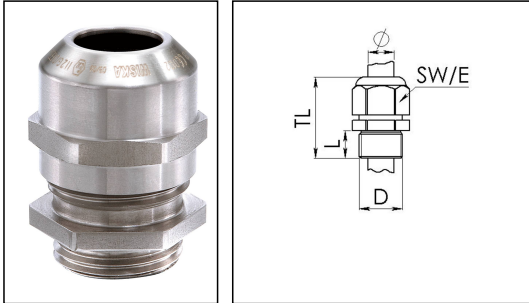

Product illustrations are exemplary and may differ from the chosen product. Further variants and individual customization, we will gladly provide you on request.



Material cable gland	Stainless steel A2 (1.4305)
Material clamping cage	Polyamide
Material sealing gasket	EPDM
Temp. range min	-40 °C
Temp. range max	75 °C
Protection class	IP 68, 5 bar 30 min, IP 69K
Marking	II 2 G Ex e IIC Gb, II 2 D Ex tb IIIC Db IP68
Approval	IECEX PTB 13.0035X, PTB 05 ATEX 1098 X
Thread type	M
Connection thread size D	63
Lead	1,5
Length screw-in thread L	10 mm
Cable diameter min	34 mm
Cable diameter max	48 mm
Cable Diameter UL	38,1 mm - 47,5 mm
Key width SW	68 mm
Collar diameter (E)	75 mm
Total length TL	56 mm - 67 mm
Type of cable anchorage	A
Install. torques fitting	30 N m
Install. torques cap nut	30 N m
Impact category	6
WISKA-Order no.	10069207
Type	ESSKE 63
Packing unit	1

ETIM-Classification

EC000441

Recommended accessories

RDE 63	10062189
BS 38	10064018
BS 48	10064019
ESMU 63	10064195

23.02.2015