

ESSKE 50

Ex-cable gland, stainless steel

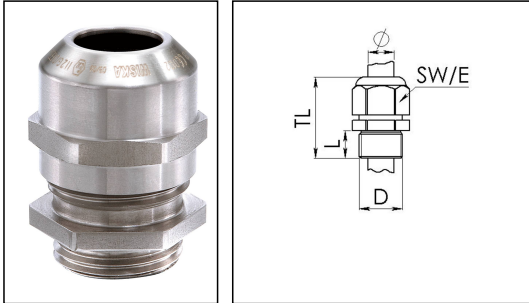

Product illustrations are exemplary and may differ from the chosen product. Further variants and individual customization, we will gladly provide you on request.



Material cable gland	Stainless steel A2 (1.4305)
Material clamping cage	Polyamide
Material sealing gasket	EPDM
Temp. range min	-40 °C
Temp. range max	75 °C
Protection class	IP 68, 5 bar 30 min, IP 69K
Marking	II 2 G Ex e IIC Gb, II 2 D Ex tb IIIC Db IP68
Approval	IECEX PTB 13.0035X, PTB 05 ATEX 1098 X
Thread type	M
Connection thread size D	50
Lead	1,5
Length screw-in thread L	9 mm
Cable diameter min	21 mm
Cable diameter max	35 mm
Cable Diameter UL	24,3 mm - 33,4 mm
Key width SW	55 mm
Collar diameter (E)	61 mm
Total length TL	51 mm - 62 mm
Type of cable anchorage	A
Install. torques fitting	30 N m
Install. torques cap nut	30 N m
Impact category	6
WISKA-Order no.	10069206
Type	ESSKE 50
Packing unit	2

ETIM-Classification

EC000441

Recommended accessories

RDE 50	10062188
BS 25	10064015
BS 35	10064017
ESMU 50	10064194

23.02.2015