

ESSKE 40

Ex-cable gland, stainless steel

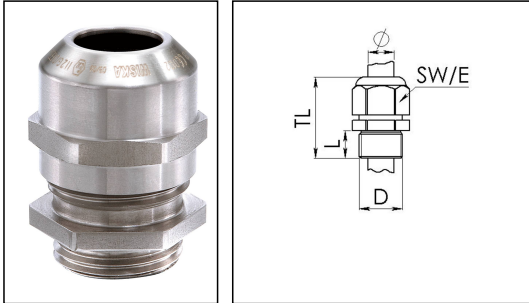

Product illustrations are exemplary and may differ from the chosen product. Further variants and individual customization, we will gladly provide you on request.



Material cable gland	Stainless steel A2 (1.4305)
Material clamping cage	Polyamide
Material sealing gasket	EPDM
Temp. range min	-40 °C
Temp. range max	75 °C
Protection class	IP 68, 5 bar 30 min, IP 69K
Marking	II 2 G Ex e IIC Gb, II 2 D Ex tb IIIC Db IP68
Approval	IECEX PTB 13.0035X, PTB 05 ATEX 1098 X
Thread type	M
Connection thread size D	40
Lead	1,5
Length screw-in thread L	8 mm
Cable diameter min	16 mm
Cable diameter max	28 mm
Cable Diameter UL	17,4 mm - 26,4 mm
Key width SW	46 mm
Collar diameter (E)	50 mm
Total length TL	44 mm - 55 mm
Type of cable anchorage	A
Install. torques fitting	25 N m
Install. torques cap nut	25 N m
Impact category	6
WISKA-Order no.	10069205
Type	ESSKE 40
Packing unit	5

ETIM-Classification

EC000441

Recommended accessories

RDE 40	10062187
BS 20	10064013
BS 28	10064016
ESMU 40	10064193

23.02.2015