

ESSKE 20

Ex-cable gland, stainless steel

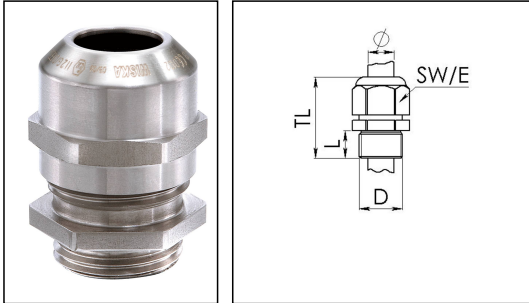

Product illustrations are exemplary and may differ from the chosen product. Further variants and individual customization, we will gladly provide you on request.



Material cable gland	Stainless steel A2 (1.4305)
Material clamping cage	Polyamide
Material sealing gasket	EPDM
Temp. range min	-40 °C
Temp. range max	75 °C
Protection class	IP 68, 5 bar 30 min, IP 69K
Marking	II 2 G Ex e IIC Gb, II 2 D Ex tb IIIC Db IP68
Approval	IECEX PTB 13.0035X, PTB 05 ATEX 1098 X
Thread type	M
Connection thread size D	20
Lead	1,5
Length screw-in thread L	6 mm
Cable diameter min	6 mm
Cable diameter max	13 mm
Cable Diameter UL	7,5 mm - 11,3 mm
Key width SW	24 mm
Collar diameter (E)	27 mm
Total length TL	29 mm - 37 mm
Type of cable anchorage	A
Install. torques fitting	10 N m
Install. torques cap nut	10 N m
Impact category	6
WISKA-Order no.	10069202
Type	ESSKE 20
Packing unit	10

ETIM-Classification

EC000441

Recommended accessories

RDE 20	10062185
BS 8	10064006
BS 13	10064010
ESMU 20	10064190

23.02.2015