

EMSKE-L 40 EMV-Z

Ex-EMC-cable gland, brass with long thread

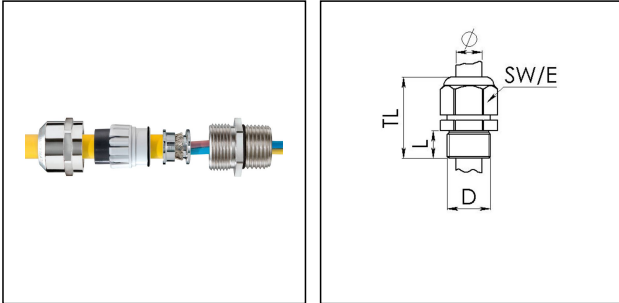

Product illustrations are exemplary and may differ from the chosen product. Further variants and individual customization, we will gladly provide you on request.



Material cable gland	Brass nickel-plated
Material clamping cage	Polyamide
Material sealing gasket	EPDM
Temp. range min	-40 °C
Temp. range max	75 °C
Protection class	IP 66 / IP 68, 5 bar 30min
Marking	II 2 D Ex tb IIIC Db IP68, II 2 G Ex e IIC Gb
Approval	PTB 04 ATEX 1112 X
Thread type	M
Connection thread size D	40
Lead	1,5
Length screw-in thread L	15 mm
Cable diameter min	16 mm
Cable diameter max	28 mm
Cable Diam. below cable shield	26 mm
Cable Diameter UL	17,4 mm - 26,4 mm
Key width SW	46 mm
Collar diameter (E)	51 mm
Total length TL	51 mm - 62 mm
Install. torques fitting	20 N m
Install. torques cap nut	20 N m
Type of cable anchorage	A
Impact category	6
Surface	Nickel-plated
Order no. nickel-plated	10065927

Type	EMSKE-L 40 EMV-Z
Packing unit	10
ETIM-Classification	EC000441

Recommended accessories

RDE 40	10062187
EMMU-EMV 40	10063215
BS 20	10064013
BS 28	10064016

23.02.2015