

EMSKE 63 EMV-Z

Ex-EMC-cable gland, brass with short thread

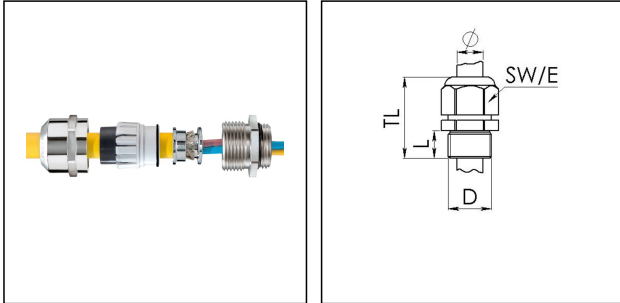

Product illustrations are exemplary and may differ from the chosen product. Further variants and individual customization, we will gladly provide you on request.



Material cable gland	Brass nickel-plated
Material clamping cage	Polyamide
Material sealing gasket	EPDM
Temp. range min	-40 °C
Temp. range max	75 °C
Protection class	IP 66 / IP 68, 5 bar 30min
Marking	II 2 D Ex tb IIIC Db IP68, II 2 G Ex e IIC Gb
Approval	PTB 04 ATEX 1112 X
Thread type	M
Connection thread size D	63
Lead	1,5
Length screw-in thread L	10 mm
Cable diameter min	34 mm
Cable diameter max	48 mm
Cable Diam. below cable shield	45 mm
Cable Diameter UL	38,1 mm - 47,5 mm
Key width SW	68 mm
Collar diameter (E)	75 mm
Total length TL	56 mm - 67 mm
Install. torques fitting	40 N m
Install. torques cap nut	40 N m
Type of cable anchorage	A
Impact category	6
Surface	Nickel-plated
Order no. nickel-plated	10065063

Type	EMSKE 63 EMV-Z
Packing unit	10
ETIM-Classification	EC000441

Recommended accessories

RDE 63	10062189
EMMU-EMV 63	10063217
BS 38	10064018
BS 48	10064019

23.02.2015